

# KENWOOD

## KMM-BT506DAB

---

DIGITAL MEDIA RECEIVER  
**INSTRUCTION MANUAL**

JVCKENWOOD Corporation



# SOFTWARE LICENSE AGREEMENT

The software embedded in the Product (hereinafter the "Licensed Software") provided by Licensor is copyrighted to or sublicensable by the Licensor, and this Agreement provides for the terms and conditions which Users shall follow in order to use the Licensed Software.

The User shall use the Licensed Software by agreeing with the terms of this Software License Agreement. This Agreement shall be deemed completed at the time the User (hereinafter the "User") initially used the Product in which the "Licensed Software" is embedded.

The Licensed Software may include the software which has been licensed to the Licensor directly or indirectly from any third party. In such case, some third parties require the Users to follow their conditions for use separately from this Software License Agreement. Such software shall not be subject to this Agreement, and the Users are urged to read the "Important Notice concerning the Software" to be provided separately below.

## Article 1 General Provision

The Licensor shall grant to the User a non-exclusive and non-transferable (other than the exceptional case referred to in Article 3, Paragraph 1) licensed to use the Licensed Software within the country of the User. (the country where the User bought the Product (hereinafter the "Country"))

## Article 2 License

1. The license granted under this Agreement shall be the right to use the Licensed Software in the Product.
2. The User shall not duplicate, copy, modify, add, translate or otherwise alter, or lease the Licensed Software and any related documents, whether in whole or in part.
3. The use of the Licensed Software shall be limited to personal purpose, and the Licensed Software shall not be distributed, licensed or sub-licensed whether it is for commercial purpose or not.
4. The User shall use the Licensed Software according to the directions described in the operation manual or help file, and is prohibited to use or duplicate any data in a manner violating the Copyright Law or any other laws and regulations by applying whole or a part of the Licensed Software.

## Article 3 Conditions for Grant of License

1. When the User transfers the Product, it may also transfer the license to use the Licensed Software embedded in the Product (including any related materials, updates and upgrades) on condition that no original, copies or related materials continue in the possession of the User, and that the User shall cause the transferee to comply with this Software License Agreement.
2. The User shall not carry out reverse engineering, disassembling, decompiling or any other code analysis works in connection with the Licensed Software.

## Article 4 Right pertaining to the Licensed Software

Any and all copyrights and other rights pertaining to the Licensed Software and related documents shall belong to the Licensor or the original holder of the right who granted to the Licensor the license or sublicense for the Licensed Software (hereinafter the "Original Rightholder"), and the User shall not be entitled to any right other than the license granted hereunder, in respect of the Licensed Software and any related documents.

## Article 5 Indemnification of Licensor

1. Neither the Licensor nor the Original Rightholder shall be liable for any damage incurred by the User or any third party due to the exercise of the license granted to the User under this Agreement, unless otherwise restricted by law.
2. The Licensor will offer no guarantee for the merchantability, convertibility and consistency with certain objective of the Licensed Software.

## Article 6 Liability to Third Party

If any dispute has arisen with any third party due to an infringement upon a copyright, patent or any other intellectual property right that was caused by the User's use of the Licensed Software, the User shall settle such dispute at its own cost and hold the Licensor and the Original Rightholder harmless from any inconvenience it may cause.

## Article 7 Confidentiality

The User shall keep the confidentiality of such portion of the Licensed Software, related documents thereof or any other information to be granted under this Agreement, as well as the conditions of this Agreement as has not yet entered the public domain, and shall not disclose or divulge the same to any third party without approval of the Licensor.

## Article 8 Termination

In case the User falls under any of the events described in the following items, the Licensor may immediately terminate this Agreement or claim that the User compensates for the damage incurred by the Licensor due to such event:

- (1) when the User violated any provision of this Agreement; or
- (2) when a petition has been filed against the User for an attachment, provisional attachment, provisional disposition or any other compulsory execution.

## Article 9 Destruction of the Licensed Software

If this Agreement is terminated pursuant to the provision of Article 8, the User shall destroy the Licensed Software, any related documents and copies thereof within two (2) weeks from such date of termination.

## Article 10 Protection of Copyright

1. The copyright and all the other intellectual property rights relating to the Licensed Software shall belong to the Licensor and the Original Rightholder, and in no event shall they be under the ownership of the User.
2. The User shall, whenever it uses the Licensed Software, comply with any laws relating to the copyright and other intellectual property rights.

## Article 11 Export Restriction

1. It is prohibited to export the Licensed Software and any related documents outside the country of the User (including transmission thereof outside the country of the User via Internet of other communication tools).
2. The User shall understand that the Licensed Software shall be subject to the export restrictions adopted by the country of User and any other countries.
3. The User shall agree that the software will be subject to any and all applicable international and domestic laws (including the export control regulation of the country of User and any other countries, and any restrictions concerning the end-users, the use by end-users and importing countries to be provided by the country of User and any other countries, and any other governmental authorities).

## Article 12 Miscellaneous

1. In the event any part of this Agreement is invalidated by operation of law, the residual provisions shall continue in force.
2. Matters not stipulated in this Agreement or any ambiguity or question raised in the construction of this Agreement shall be provided or settled upon good-faith consultation between the Licensor and the User.
3. The Licensor and the User hereby agree that this Agreement is governed by the laws of Japan, and any dispute arising from, and relating to the rights and obligations under, this Agreement shall be submitted to the exclusive jurisdiction of the Tokyo District Court for its first instance.

## Important Notice concerning the Software

---

-jansson

Copyright (c) 2009-2012 Petri Lehtinen <petri@digip.org>

Permission is hereby granted, free of charge, to any person obtaining a copy of this software and associated documentation files (the "Software"), to deal in the Software without restriction, including without limitation the rights to use, copy, modify, merge, publish, distribute, sublicense, and/or sell copies of the Software, and to permit persons to whom the Software is furnished to do so, subject to the following conditions:

The above copyright notice and this permission notice shall be included in all copies or substantial portions of the Software.

THE SOFTWARE IS PROVIDED "AS IS", WITHOUT WARRANTY OF ANY KIND, EXPRESS OR IMPLIED, INCLUDING BUT NOT LIMITED TO THE WARRANTIES OF MERCHANTABILITY, FITNESS FOR A PARTICULAR PURPOSE AND NONINFRINGEMENT. IN NO EVENT SHALL THE AUTHORS OR COPYRIGHT HOLDERS BE LIABLE FOR ANY CLAIM, DAMAGES OR OTHER LIABILITY, WHETHER IN AN ACTION OF CONTRACT, TORT OR OTHERWISE, ARISING FROM, OUT OF OR IN CONNECTION WITH THE SOFTWARE OR THE USE OR OTHER DEALINGS IN THE SOFTWARE.

---

-cJSON

Copyright (c) 2009 Dave Gamble

Permission is hereby granted, free of charge, to any person obtaining a copy of this software and associated documentation files (the "Software"), to deal in the Software without restriction, including without limitation the rights to use, copy, modify, merge, publish, distribute, sublicense, and/or sell copies of the Software, and to permit persons to whom the Software is furnished to do so, subject to the following conditions:

The above copyright notice and this permission notice shall be included in all copies or substantial portions of the Software.

THE SOFTWARE IS PROVIDED "AS IS", WITHOUT WARRANTY OF ANY KIND, EXPRESS OR IMPLIED, INCLUDING BUT NOT LIMITED TO THE WARRANTIES OF MERCHANTABILITY, FITNESS FOR A PARTICULAR PURPOSE AND NONINFRINGEMENT. IN NO EVENT SHALL THE AUTHORS OR COPYRIGHT HOLDERS BE LIABLE FOR ANY CLAIM, DAMAGES OR OTHER LIABILITY, WHETHER IN AN ACTION OF CONTRACT, TORT OR OTHERWISE, ARISING FROM, OUT OF OR IN CONNECTION WITH THE SOFTWARE OR THE USE OR OTHER DEALINGS IN THE SOFTWARE.

---

-CMP

The MIT License (MIT)

Copyright (c) 2014 Charles Gunyon

Permission is hereby granted, free of charge, to any person obtaining a copy of this software and associated documentation files (the "Software"), to deal in the Software without restriction, including without limitation the rights to use, copy, modify, merge, publish, distribute, sublicense, and/or sell copies of the Software, and to permit persons to whom the Software is furnished to do so, subject to the following conditions:

The above copyright notice and this permission notice shall be included in all copies or substantial portions of the Software.

THE SOFTWARE IS PROVIDED "AS IS", WITHOUT WARRANTY OF ANY KIND, EXPRESS OR IMPLIED, INCLUDING BUT NOT LIMITED TO THE WARRANTIES OF MERCHANTABILITY, FITNESS FOR A PARTICULAR PURPOSE AND NONINFRINGEMENT. IN NO EVENT SHALL THE AUTHORS OR COPYRIGHT HOLDERS BE LIABLE FOR ANY CLAIM, DAMAGES OR OTHER LIABILITY, WHETHER IN AN ACTION OF CONTRACT, TORT OR OTHERWISE, ARISING FROM, OUT OF OR IN CONNECTION WITH THE SOFTWARE OR THE USE OR OTHER DEALINGS IN THE SOFTWARE.

---

nanopb

Copyright (c) 2011 Petteri Aimonen <jpa at nanopb.mail.kapsi.fi>

This software is provided 'as-is', without any express or implied warranty. In no event will the authors be held liable for any damages arising from the use of this software.

Permission is granted to anyone to use this software for any purpose, including commercial applications, and to alter it and redistribute it freely, subject to the following restrictions:

1. The origin of this software must not be misrepresented; you must not claim that you wrote the original software. If you use this software in a product, an acknowledgment in the product documentation would be appreciated but is not required.
2. Altered source versions must be plainly marked as such, and must not be misrepresented as being the original software.
3. This notice may not be removed or altered from any source distribution.

sha2

AUTHOR: Aaron D. Gifford - <http://www.aarongifford.com/>

Copyright (c) 2000-2001, Aaron D. Gifford

All rights reserved.

You may obtain a copy of the license at

<https://opensource.org/licenses/BSD-3-Clause>

THE SOFTWARE IS PROVIDED "AS IS", WITHOUT WARRANTY OF ANY KIND, EXPRESS OR IMPLIED, INCLUDING BUT NOT LIMITED TO THE WARRANTIES OF MERCHANTABILITY, FITNESS FOR A PARTICULAR PURPOSE AND NONINFRINGEMENT. IN NO EVENT SHALL THE AUTHORS OR COPYRIGHT HOLDERS BE LIABLE FOR ANY CLAIM, DAMAGES OR OTHER LIABILITY, WHETHER IN AN ACTION OF CONTRACT, TORT OR OTHERWISE, ARISING FROM, OUT OF OR IN CONNECTION WITH THE SOFTWARE OR THE USE OR OTHER DEALINGS IN THE SOFTWARE.

---

Posix

Copyright (c) 1990, 1993

The Regents of the University of California. All rights reserved.

Redistribution and use in source and binary forms, with or without modification, are permitted provided that the following conditions are met:

1. Redistributions of source code must retain the above copyright notice, this list of conditions and the following disclaimer.
2. Redistributions in binary form must reproduce the above copyright notice, this list of conditions and the following disclaimer in the documentation and/or other materials provided with the distribution.
3. All advertising materials mentioning features or use of this software must display the following acknowledgement:  
This product includes software developed by the University of California, Berkeley and its contributors.
4. Neither the name of the University nor the names of its contributors may be used to endorse or promote products derived from this software without specific prior written permission.

Copyright (C) 1993 by Sun Microsystems, Inc. All rights reserved.

Developed at SunPro, a Sun Microsystems, Inc. business.

Permission to use, copy, modify, and distribute this software is freely granted, provided that this notice is preserved.

---

Copyright (C) 1991-2, RSA Data Security, Inc. Created 1991. All rights reserved.

License to copy and use this software is granted provided that it is identified as the "RSA Data Security, Inc. MD4 Message-Digest Algorithm" in all material mentioning or referencing this software or this function.

Copyright (c) 1995, 1996 Carnegie-Mellon University. All rights reserved.

Author: Chris G. Demetriou

Permission to use, copy, modify and distribute this software and its documentation is hereby granted, provided that both the copyright notice and this permission notice appear in all copies of the software, derivative works or modified versions, and any portions thereof, and that both notices appear in supporting documentation.

CARNEGIE MELLON ALLOWS FREE USE OF THIS SOFTWARE IN ITS "AS IS" CONDITION. CARNEGIE MELLON DISCLAIMS ANY LIABILITY OF ANY KIND FOR ANY DAMAGES WHATSOEVER RESULTING FROM THE USE OF THIS SOFTWARE.

Carnegie Mellon requests users of this software to return to

Software Distribution Coordinator or Software.Distribution@CS.CMU.EDU

School of Computer Science

Carnegie Mellon University

Pittsburgh PA 15213-3890

any improvements or extensions that they make and grant Carnegie the rights to redistribute these changes.

License is also granted to make and use derivative works provided that such works are identified as "derived from the RSA Data Security, Inc. MD4 Message-Digest Algorithm" in all material mentioning or referencing the derived work.

RSA Data Security, Inc. makes no representations concerning either the merchantability of this software or the suitability of this software for any particular purpose. It is provided "as is" without express or implied warranty of any kind.

Copyright (c) 1993 Martin Birgmeier

All rights reserved.

You may redistribute unmodified or modified versions of this source code provided that the above copyright notice and this and the following conditions are retained.

This software is provided "as is", and comes with no warranties of any kind. I shall in no event be liable for anything that happens to anyone/anything when using this software.

These notices must be retained in any copies of any part of this documentation and/or software.

---

T-Kernel 2.0

This product uses the source code of T-Kernel 2.0 under T-License 2.0 granted by T-Engine Forum ([www.tron.org](http://www.tron.org))

BSD-3-Clause

Copyright (c) 2000-2001, Aaron D. Gifford

All rights reserved.

You may obtain a copy of the license at

<https://opensource.org/licenses/BSD-3-Clause>

THE SOFTWARE IS PROVIDED "AS IS", WITHOUT WARRANTY OF ANY KIND, EXPRESS OR IMPLIED, INCLUDING BUT NOT LIMITED TO THE WARRANTIES OF MERCHANTABILITY, FITNESS FOR A PARTICULAR PURPOSE AND NONINFRINGEMENT. IN NO EVENT SHALL THE AUTHORS OR COPYRIGHT HOLDERS BE LIABLE FOR ANY CLAIM, DAMAGES OR OTHER LIABILITY, WHETHER IN AN ACTION OF CONTRACT, TORT OR OTHERWISE, ARISING FROM, OUT OF OR IN CONNECTION WITH THE SOFTWARE OR THE USE OR OTHER DEALINGS IN THE SOFTWARE.

---

LF5 Subsystem

Copyright The Regents of the University of California. All rights reserved.

You may obtain a copy of the license at

<https://directory.fsf.org/wiki/License:BSD-4-Clause>

THE SOFTWARE IS PROVIDED "AS IS", WITHOUT WARRANTY OF ANY KIND, EXPRESS OR IMPLIED, INCLUDING BUT NOT LIMITED TO THE WARRANTIES OF MERCHANTABILITY, FITNESS FOR A PARTICULAR PURPOSE AND NONINFRINGEMENT. IN NO EVENT SHALL THE AUTHORS OR COPYRIGHT HOLDERS BE LIABLE FOR ANY CLAIM, DAMAGES OR OTHER LIABILITY, WHETHER IN AN ACTION OF CONTRACT, TORT OR OTHERWISE, ARISING FROM, OUT OF OR IN CONNECTION WITH THE SOFTWARE OR THE USE OR OTHER DEALINGS IN THE SOFTWARE.

---

Accordo2 Player

Apache License

Licensed under the Apache License,

Version 2.0, January 2004(the "License");

You may obtain a copy of the license at

<http://www.apache.org/licenses/LICENSE-2.0>

THE SOFTWARE IS PROVIDED "AS IS", WITHOUT WARRANTY OF ANY KIND, EXPRESS OR IMPLIED, INCLUDING BUT NOT LIMITED TO THE WARRANTIES OF MERCHANTABILITY, FITNESS FOR A PARTICULAR PURPOSE AND NONINFRINGEMENT. IN NO EVENT SHALL THE AUTHORS OR COPYRIGHT HOLDERS BE LIABLE FOR ANY CLAIM, DAMAGES OR OTHER LIABILITY, WHETHER IN AN ACTION OF CONTRACT, TORT OR OTHERWISE, ARISING FROM, OUT OF OR IN CONNECTION WITH THE SOFTWARE OR THE USE OR OTHER DEALINGS IN THE SOFTWARE.

---

# Contents

---

|                                       |    |                                      |    |
|---------------------------------------|----|--------------------------------------|----|
| <b>Before Use</b> .....               | 3  | <b>Audio Settings</b> .....          | 24 |
| <b>Basics</b> .....                   | 4  | <b>Display Settings</b> .....        | 29 |
| <b>Getting Started</b> .....          | 5  | <b>Installation/Connection</b> ..... | 30 |
| 1 Cancel the demonstration            |    | <b>References</b> .....              | 37 |
| 2 Set the clock and date              |    | Maintenance                          |    |
| 3 Set the other optional settings     |    | More information                     |    |
| <b>Digital Radio</b> .....            | 7  | Change the display information       |    |
| <b>Analog Radio</b> .....             | 9  | <b>Troubleshooting</b> .....         | 38 |
| <b>USB/iPod</b> .....                 | 11 | <b>Specifications</b> .....          | 41 |
| <b>Spotify</b> .....                  | 13 |                                      |    |
| <b>AUX</b> .....                      | 15 |                                      |    |
| <b>Using Other Applications</b> ..... | 15 |                                      |    |
| KENWOOD Remote application            |    |                                      |    |
| TuneIn Radio/TuneIn Radio Pro         |    |                                      |    |
| <b>Bluetooth®</b> .....               | 17 |                                      |    |
| Bluetooth – Connection                |    |                                      |    |
| Bluetooth – Mobile phone              |    |                                      |    |
| Bluetooth – Audio                     |    |                                      |    |
| <b>AMAZON ALEXA</b> .....             | 23 |                                      |    |

# Before Use

## IMPORTANT

- To ensure proper use, please read through this manual before using this product. It is especially important that you read and observe Warnings and Cautions in this manual.
- Please keep the manual in a safe and accessible place for future reference.

## ▲ WARNING

- **Do not operate any function that takes your attention away from safe driving.**

## ▲ CAUTION

### Volume setting:

- Adjust the volume so that you can hear sounds outside the car to prevent accidents.
- Lower the volume before playing digital sources to avoid damaging the speakers by the sudden increase of the output level.

### General:

- Avoid using the external device if it might hinder safe driving.
- Make sure all important data has been backed up. We shall bear no responsibility for any loss of recorded data.
- Never put or leave any metallic objects (such as coins or metal tools) inside the unit to prevent a short circuit.
- USB rating is indicated on the main unit. To view, detach the faceplate. (Page 4)
- Depending on the types of cars, the antenna will automatically extend when you turn on the unit with the antenna control wire connected (page 33). Turn off the unit or change the source to STANDBY when parking at a low ceiling area.

## How to read this manual

- The displays and faceplates shown in this manual are examples used to provide clear explanations of the operations. For this reason, they may be different from the actual displays or faceplates.
- Operations are explained mainly using buttons on the faceplate.
- [XX] indicates the selected items.
- (Page XX) indicates references are available on the stated page.



This symbol on the product means there are important operating and maintenance instructions in this manual. Be sure to carefully read instructions in this manual.

# Basics

## Faceplate

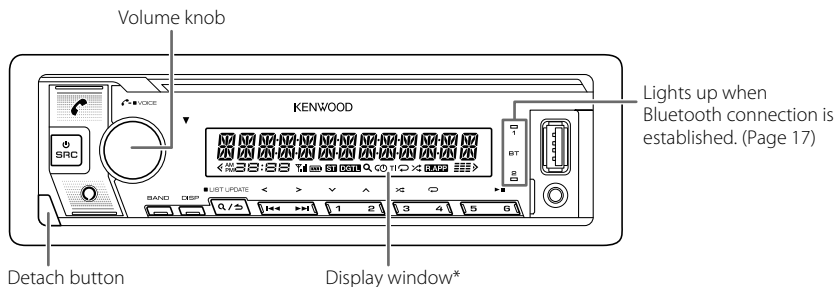

### Attach



### Detach

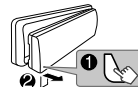

### How to reset

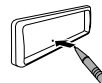

Reset the unit within 5 seconds after detaching the faceplate.

\* Only for illustration purpose.

### To

### On the faceplate

Turn on the power

Press **⏻**SRC.  
• Press and hold to turn off the power.

Adjust the volume

Turn the volume knob.

Select a source

• Press **⏻**SRC repeatedly.  
• Press **⏻**SRC, then turn the volume knob within 2 seconds.

Change the display information

Press **DISP** repeatedly. (Page 38)



# Getting Started

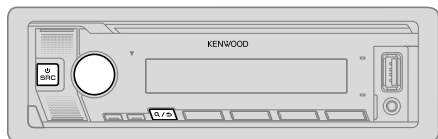

## 1 Cancel the demonstration

When you turn on the power for the first time (or [FACTORY RESET] is set to [YES], see page 6), the display shows: "CANCEL DEMO" → "PRESS" → "VOLUME KNOB"

- 1 Press the volume knob.  
[YES] is selected for the initial setup.
- 2 Press the volume knob again.  
"DEMO OFF" appears.

Then, the display shows the selected crossover type: "2-WAY X ' OVER" or "3-WAY X ' OVER"

- To change the crossover type, see "Change the crossover type" on page 6.

## 2 Set the clock and date

- 1 Press the volume knob to enter [FUNCTION].
- 2 Turn the volume knob to select [CLOCK], then press the knob.

### To adjust the clock

- 3 Turn the volume knob to select [CLOCK ADJUST], then press the knob.
- 4 Turn the volume knob to make the settings, then press the knob.  
Set the time in the order of "Hour" → "Minute".
- 5 Turn the volume knob to select [CLOCK FORMAT], then press the knob.
- 6 Turn the volume knob to select [12H] or [24H], then press the knob.

### To set the date

- 7 Turn the volume knob to select [DATE FORMAT], then press the knob.
- 8 Turn the volume knob to select [DD/MM/YY] or [MM/DD/YY], then press the knob.
- 9 Turn the volume knob to select [DATE SET], then press the knob.
- 10 Turn the volume knob to make the settings, then press the knob.  
Set the date in the order of "Day" → "Month" → "Year" or "Month" → "Day" → "Year".

- 11 Press and hold **Q/↵** to exit.

To return to the previous setting item, press **Q/↵**.

## 3 Set the other optional settings

You can only set the following items while the unit is in STANDBY source.

- 1 Press **⏻SRC** repeatedly to enter STANDBY.
- 2 Press the volume knob to enter [FUNCTION].
- 3 Turn the volume knob to select an item (page 6), then press the knob.
- 4 Repeat step 3 until the desired item is selected or activated.
- 5 Press and hold **Q/↵** to exit.

To return to the previous setting item, press **Q/↵**.

## Getting Started

Default: **[XX]**

|                        |   |
|------------------------|---|
| <b>[DISPLAY]</b>       |   |
| <b>[EASY MENU]</b>     | When entering <b>[FUNCTION]</b> ...<br><b>[ON]</b> : <b>[ZONE 1]</b> illumination changes to white color. ;<br><b>[OFF]</b> : <b>[ZONE 1]</b> illumination remains as <b>[COLOR SELECT]</b> color. (Page 29) <ul style="list-style-type: none"><li>• <b>[ZONE 2]</b> illumination changes to light blue color when you enter <b>[FUNCTION]</b>, irregardless of the <b>[EASY MENU]</b> setting.</li><li>• Refer to the illustration on page 29 for zone identification.</li></ul> |
| <b>[TUNER SETTING]</b> |   |
| <b>[DAB ANT POWER]</b> | <b>[ON]</b> : Supplies power to the DAB antenna. ; <b>[OFF]</b> : Does not supply power. Selects when using passive antenna without booster. (Page 34)  |
| <b>[PRESET TYPE]</b>   | <b>[NORMAL]</b> : Memorizes one station for each preset button in each band (FM1/FM2/FM3/AM/DB1/DB2/DB3). ; <b>[MIX]</b> : Memorizes one station (digital radio or analog radio) for each preset button, regardless of the selected band.   |
| <b>[SYSTEM]</b>        |   |
| <b>[KEY BEEP]</b>      | (Applicable only if <b>[X'OVER]</b> is set to <b>[2WAY]</b> .)<br><b>[ON]</b> : Activates the keypress tone. ; <b>[OFF]</b> : Deactivates.  |
| <b>[TDF ALARM]</b>     | (Applicable only if <b>[X'OVER]</b> is set to <b>[2WAY]</b> .)<br><b>[ON]</b> : Activates the alarm if you forget to detach the faceplate when ACC is set to OFF. ; <b>[OFF]</b> : Deactivates.   |
| <b>[SOURCE SELECT]</b> |   |
| <b>[SPOTIFY SRC]</b>   | <b>[ON]</b> : Enables SPOTIFY/SPOTIFY BT in source selection. ;<br><b>[OFF]</b> : Disables. (Page 13)   |
| <b>[BT AUDIO SRC]</b>  | <b>[ON]</b> : Enables BT AUDIO in source selection. ; <b>[OFF]</b> : Disables. (Page 22)  |
| <b>[BUILT-IN AUX]</b>  | <b>[ON]</b> : Enables AUX in source selection. ; <b>[OFF]</b> : Disables. (Page 15)   |

### **[F/W UPDATE]**

#### **[UPDATE SYSTEM]/ [UPDATE DAB]**

**[F/W UP xxxx]/ [F/W UP xxxxx]** **[YES]**: Starts upgrading the firmware. ; **[NO]**: Cancels (upgrading is not activated).

For details on how to update the firmware, visit  
<[www.kenwood.com/cs/ce/](http://www.kenwood.com/cs/ce/)>.

**[FACTORY RESET]** **[YES]**: Resets the settings to default (except the stored station). ;  
**[NO]**: Cancels.

## Change the crossover type

- 1 Press **⏻** SRC repeatedly to enter STANDBY.
- 2 Press and hold number buttons 4 and 5 to enter crossover select. The current crossover type appears.
- 3 Turn the volume knob to select "2WAY" or "3WAY", then press the knob.
- 4 Turn the volume knob to select "YES" or "NO", then press the knob. The selected crossover type appears.

- To cancel, press and hold **⏻** / **⏪**.
- To adjust the selected crossover settings, see page 26.

### **▲ CAUTION**

Select a crossover type according to how the speakers are connected. (Page 32, 33)

If you select a wrong type:

- The speakers may damage.
- The output sound level may be extremely high or low.

# Digital Radio

## About DAB (Digital Audio Broadcasting)

DAB is one of the digital radio broadcasting systems available today. It can deliver digital quality sound without any annoying interference or signal distortion. Furthermore, it can carry text, pictures and data.

In contrast to FM broadcast, where each program is transmitted on its own frequency, DAB combines several programs (called "services") to form one "ensemble."

The "primary component" (main radio station) is sometimes accompanied by a "secondary component" which can contain extra programs or other information.

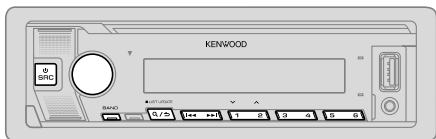

### Preparation:

- 1 Connect the supplied DAB antenna to the DAB antenna jack. (Page 32)
  - 2 Press  $\odot$  SRC repeatedly to select DIGITAL AUDIO.
  - 3 Press and hold  $\mathcal{Q}/\mathcal{S}$  (LIST UPDATE) to start the Service List update. "LIST UPDATE" appears and update starts. "UPDATED" appears when update completes. Updates take up to 3 minutes. No interruption (such as traffic information) is possible during updates.
- **To cancel the Service List update:** Press and hold  $\mathcal{Q}/\mathcal{S}$  (LIST UPDATE) again.
  - "DGTL" lights up when receiving DAB digital signal and flashes when receiving a RDS signal.
  - The unit switches to DAB alarm automatically when receiving an alarm signal from DAB broadcast.

## Search for an ensemble

- 1 Press  $\odot$  SRC repeatedly to select DIGITAL AUDIO.
- 2 Press BAND repeatedly to select DB1/DB2/DB3.
- 3 Press and hold  $\lll / \ggg$  to search for an ensemble.
- 4 Press  $\lll / \ggg$  to select an ensemble, service or component to listen.

You can store up to 18 services.

- **To store a service:** Press and hold one of the number buttons (1 to 6).
- **To select a stored service:** Press one of the number buttons (1 to 6).

## Select a service

- 1 Press  $\mathcal{Q}/\mathcal{S}$  to enter Service Search mode.
- 2 Turn the volume knob to select a service, then press the knob.

To cancel the Service Search mode, press  $\mathcal{Q}/\mathcal{S}$  again.

## Select a service by name

- 1 Press  $\mathcal{Q}/\mathcal{S}$  to enter Service Search mode.
- 2 Turn the volume knob quickly to enter Alphabet Search mode.
- 3 Turn the volume knob or press  $\lll / \ggg$  to select the character to be searched for.
  - Press  $\vee / \wedge$  to go to the previous/next page.
- 4 Press the volume knob to start searching.
- 5 Turn the volume knob to select a service, then press the knob.

To cancel the Alphabet Search mode, press  $\mathcal{Q}/\mathcal{S}$  again.

## Digital Radio

### Other settings

- 1 Press the volume knob to enter [FUNCTION].
- 2 Turn the volume knob to select an item (see the following table), then press the knob.
- 3 Repeat step 2 until the desired item is selected/activated or follow the instructions stated on the selected item.
- 4 Press and hold **Q/S** to exit.

To return to the previous setting item, press **Q/S**.

Default: [XX]

| [TUNER SETTING] |  |
|-----------------|--|
| [SEEK MODE]     | Selects the searching method for <b>◀◀ / ▶▶</b> buttons when pressed.<br>[AUTO1]: Select an ensemble, service or component. Pressing and holding <b>◀◀ / ▶▶</b> automatically search for an ensemble. ; [AUTO2]: Search for a preset service. ; [MANUAL]: Select an ensemble, service or component. Pressing and holding <b>◀◀ / ▶▶</b> manually search for an ensemble. |
| [AF SET]        | [ON]:<br>While listening to DAB: Automatically switch to FM broadcasting the same program if the DAB signal becomes weak. It will switch back to DAB sound when the signal becomes strong again.<br>While listening to FM: Automatically switch to DIGITAL AUDIO source broadcasting the same program (if available). ;<br>[OFF]: Cancels.                               |
| [TI]            | [ON]: Allows the unit to temporarily switch to Traffic Information if available ("TI" indicator lights up). ; [OFF]: Cancels.  |
| [PTY SEARCH]    | <ol style="list-style-type: none"><li>1 Turn the volume knob to select the available Program Type (see "Available Program Type for [PTY SEARCH]" on page 9), then press the knob.</li><li>2 Turn the volume knob to select the PTY language ([ENGLISH]/[FRENCH]/[GERMAN]), then press the knob.</li><li>3 Press <b>◀◀ / ▶▶</b> to start searching.</li></ol>             |

[ASW SELECT] [TRAVEL], [WARNINGS], [NEWS], [WEATHER], [EVENT], [SPECIAL], [RAD INFO], [SPORTS], [FINANCE]: Turn the volume knob to make a selection, then press the knob.

"✳" appears in front of the activated announcement type.

Automatically switch from any source to Digital radio ensembles broadcasting an activated announcement type.

- Multiple announcement can be activated simultaneously.
- To deactivate, press the volume knob again ("✳" goes off).

[LIST UPDATE] [AUTO]: Automatically update the DAB Service List when the power is turned on. ; [MANUAL]: Updates the DAB Service List by pressing and holding **Q/S** (LIST UPDATE).

[PTY WATCH] 

- 1 Turn the volume knob to select the available Program Type, then press **Q/S**.

The unit automatically switch from any source to Digital Radio ensembles broadcasting the selected type of program.

Program Type:

[NEWS], [AFFAIRS], [INFO], [SPORT], [EDUCATE], [DRAMA], [CULTURE], [SCIENCE], [VARIED], [POP M] (music), [ROCK M] (music), [EASY M] (music), [LIGHT M] (music), [CLASSICS], [OTHER M] (music), [WEATHER], [FINANCE], [CHILDREN], [SOCIAL], [RELIGION], [PHONE IN], [TRAVEL], [LEISURE], [JAZZ], [COUNTRY], [NATION M] (music), [OLDIES], [FOLK M] (music), [DOCUMENT]

[OFF]: Cancels.

- 2 Press the volume knob to enter PTY language selection.

- 3 Turn the volume knob to select the PTY language ([ENGLISH]/[FRENCH]/[GERMAN]), then press the knob.

[RELATED SERV] [ON]: Enable Soft-Link function to switch to an alternative service which is different audio program from the current audio program. ; [OFF]: Disable.

### [CLOCK]

[TIME SYNC] [ON]: Synchronizes the unit's time to the Digital Radio station time. ; [OFF]: Cancels.

## Digital Radio

- If the volume is adjusted during reception of traffic information, announcement, alarm or news bulletin, the adjusted volume is memorized automatically. It will be applied the next time traffic information, announcement, alarm or news bulletin is turned on.

### Available Program Type for [PTY SEARCH]

[SPEECH]:

[NEWS], [AFFAIRS], [INFO] (information), [SPORT], [EDUCATE], [DRAMA], [CULTURE], [SCIENCE], [VARIED], [WEATHER], [FINANCE], [CHILDREN], [SOCIAL], [RELIGION], [PHONE IN], [TRAVEL], [LEISURE], [DOCUMENT]

[MUSIC]:

[POP M] (music), [ROCK M] (music), [EASY M] (music), [LIGHT M] (music), [CLASSICS], [OTHER M] (music), [JAZZ], [COUNTRY], [NATION M] (music), [OLDIES], [FOLK M] (music)

The unit will search for the Program Type categorized under [SPEECH] or [MUSIC] if selected.

## Analog Radio

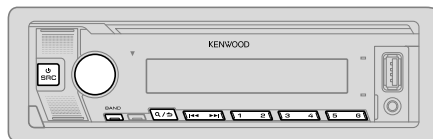

- “ST” indicator lights up when receiving an FM stereo broadcast with sufficient signal strength.
- The unit switches to FM alarm automatically when receiving an alarm signal from FM broadcast.

### Search for a station

- 1 Press **SRC** repeatedly to select RADIO.
- 2 Press **BAND** repeatedly to select FM1/FM2/FM3/AM.
- 3 Press **◀▶** to search for a station.

You can store up to 18 stations for FM and 6 stations for AM.

- **To store a station:** Press and hold one of the number buttons (1 to 6).
- **To select a stored station:** Press one of the number buttons (1 to 6).

### Other settings

- 1 Press the volume knob to enter [FUNCTION].
- 2 Turn the volume knob to select an item (page 10), then press the knob.
- 3 Repeat step 2 until the desired item is selected/activated or follow the instructions stated on the selected item.
- 4 Press and hold **Q/↵** to exit.

To return to the previous setting item, press **Q/↵**.

Default: **[XX]**

|                        |  |
|------------------------|--|
| <b>[TUNER SETTING]</b> |  |
| <b>[SEEK MODE]</b>     | Selects the searching method for <b>[◀◀ / ▶▶]</b> buttons when pressed.<br><b>[AUTO1]</b> : Automatically search for a station. ; <b>[AUTO2]</b> : Search for a preset station. ; <b>[MANUAL]</b> : Manually search for a station.   |
| <b>[LOCAL SEEK]</b>    | <b>[ON]</b> : Searches only AM stations with good reception. ; <b>[OFF]</b> : Cancels.<br>• Settings made are applicable only to the selected source/station. Once you change the source/station, you need to make the settings again.   |
| <b>[AUTO MEMORY]</b>   | <b>[YES]</b> : Automatically starts memorizing 6 stations with good reception. ; <b>[NO]</b> : Cancels.<br>• Selectable only if <b>[NORMAL]</b> is selected for <b>[PRESET TYPE]</b> . (Page 6)  |
| <b>[MONO SET]</b>      | <b>[ON]</b> : Improves the FM reception, but the stereo effect will be lost. ; <b>[OFF]</b> : Cancels.   |
| <b>[NEWS SET]</b>      | <b>[ON]</b> : The unit will temporarily switch to News Programme if available. ; <b>[OFF]</b> : Cancels.   |
| <b>[REGIONAL]</b>      | <b>[ON]</b> : Switches to another station only in the specific region using the "AF" control. ; <b>[OFF]</b> : Cancels.  |
| <b>[AF SET]</b>        | <b>[ON]</b> : Automatically searches for another station broadcasting the same program in the same Radio Data System network with better reception when the current reception is poor. ; <b>[OFF]</b> : Cancels.   |
| <b>[TI]</b>            | <b>[ON]</b> : Allows the unit to temporarily switch to Traffic Information if available ("TI" indicator lights up). ; <b>[OFF]</b> : Cancels.<br>• <b>[TI]</b> in AM band is for enabling traffic interruption to DIGITAL AUDIO source only.   |
| <b>[PTY SEARCH]</b>    | <b>1</b> Turn the volume knob to select the available Program Type (see the following "Available Program Type for <b>[PTY SEARCH]</b> "), then press the knob.<br><b>2</b> Turn the volume knob to select the PTY language ( <b>[ENGLISH]</b> / <b>[FRENCH]</b> / <b>[GERMAN]</b> ), then press the knob.<br><b>3</b> Press <b>[◀◀ / ▶▶]</b> to start searching. |

- **[MONO SET]**/**[NEWS SET]**/**[REGIONAL]**/**[AF SET]**/**[PTY SEARCH]** is selectable only when the band is FM1/FM2/FM3.
- If the volume is adjusted during reception of traffic information or news bulletin, the adjusted volume is memorized automatically. It will be applied the next time traffic information or news bulletin is turned on.

### Available Program Type for **[PTY SEARCH]**

#### **[SPEECH]**:

**[NEWS]**, **[AFFAIRS]**, **[INFO]** (information), **[SPORT]**, **[EDUCATE]**, **[DRAMA]**, **[CULTURE]**, **[SCIENCE]**, **[VARIED]**, **[WEATHER]**, **[FINANCE]**, **[CHILDREN]**, **[SOCIAL]**, **[RELIGION]**, **[PHONE IN]**, **[TRAVEL]**, **[LEISURE]**, **[DOCUMENT]**

#### **[MUSIC]**:

**[POP M]** (music), **[ROCK M]** (music), **[EASY M]** (music), **[LIGHT M]** (music), **[CLASSICS]**, **[OTHER M]** (music), **[JAZZ]**, **[COUNTRY]**, **[NATION M]** (music), **[OLDIES]**, **[FOLK M]** (music)

The unit will search for the Program Type categorized under **[SPEECH]** or **[MUSIC]** if selected.

# USB/iPod

## Connect a USB device

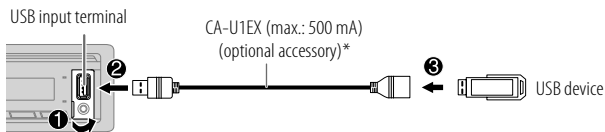

The source changes to USB automatically and playback starts.

\* Do not leave the cable inside the car when not in use.

## Connect an iPod/iPhone

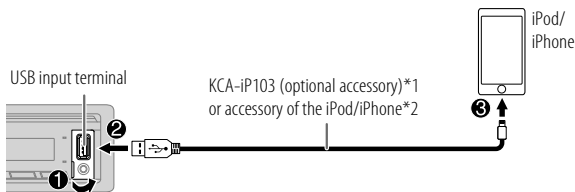

The source changes to iPod USB automatically and playback starts.

• You can also connect iPod/iPhone via Bluetooth. (Page 17)

\*1 KCA-iP103: Lightning type

\*2 Do not leave the cable inside the car when not in use.

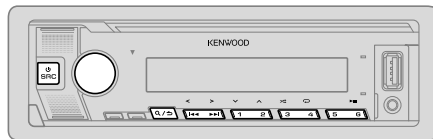

| To                   | On the faceplate   |
|----------------------|--|
| Play back/pause      | Press 6 <b>▶  </b> .   |
| Reverse/Fast-forward | Press and hold <b>◀◀ / ▶▶</b> .  |
| Select a file        | Press <b>◀◀ / ▶▶</b> .   |
| Select a folder*1    | Press 2 <b>^</b> / 1 <b>v</b> .  |
| Repeat play*2        | Press 4 <b>↺</b> repeatedly.<br>[FILE REPEAT]/[FOLDER REPEAT]/[ALL REPEAT]: MP3/WMA/AAC/WAV/FLAC file<br>[REPEAT ONE]/[REPEAT ALL]/[REPEAT OFF]: iPod                              |
| Random play*2        | Press 3 <b>↻</b> repeatedly.<br>[FOLDER RANDOM]/[RANDOM OFF]: MP3/WMA/AAC/WAV/FLAC file<br>[SHUFFLE ON]/[SHUFFLE OFF]: iPod<br>Press and hold 3 <b>↻</b> to select [ALL RANDOM].*1 |

\*1 This does not work for iPod.

\*2 For iPod: Applicable only when [MODE OFF] is selected. (Page 12)

## USB/iPod

### Select music drive

While in USB source, press **5** repeatedly.

Stored songs in the following drive will be played back.

- Selected internal or external memory of a smartphone (Mass Storage Class).
- Selected drive of a multiple drive device.

You can also select the music drive from the **[FUNCTION]** menu.

- 1 Press the volume knob to enter **[FUNCTION]**.
- 2 Turn the volume knob to select **[USB]**, then press the knob.
- 3 Turn the volume knob to select **[MUSIC DRIVE]**, then press the knob.
- 4 Turn the volume knob to select **[DRIVE CHANGE]**, then press the knob.  
The next drive (**[DRIVE 1]** to **[DRIVE 4]**) is selected automatically and playback starts.
- 5 Repeat step 1 to step 4 to select the following drives.
- 6 Press and hold **Q/↵** to exit.

To return to the previous setting item, press **Q/↵**.

### Select control mode

While in iPod USB source (or iPod BT source), press **5** repeatedly.

**[MODE ON]:** Control iPod/iPhone using the iPod/iPhone itself. However, you can still perform play/pause, file skip, fast-forward or fast-reverse from this unit.

**[MODE OFF]:** Control iPod/iPhone from this unit.

### Select a file to play

#### ■ From a folder or list

- For iPod, applicable only when **[MODE OFF]** is selected.

- 1 Press **Q/↵**.
- 2 Turn the volume knob to select a folder/list, then press the knob.
- 3 Turn the volume knob to select a file, then press the knob.  
Selected file starts playing.

#### ■ Quick search (applicable only for USB source)

If you have many files, you can search through them quickly.

- 1 Press **Q/↵**.
- 2 Turn the volume knob to select a folder/list, then press the knob.
- 3 Turn the volume knob quickly to browse through the list quickly.
- 4 Turn the volume knob to select a file, then press the knob.  
Selected file starts playing.

#### ■ Skip search (applicable only for iPod USB source and iPod BT source)

If you have many files in the selected list, you can perform the following to search for a file by skipping through the list at a rate selected in **[SKIP SEARCH]**. (Page 13)

- For iPod, applicable only when **[MODE OFF]** is selected.

- 1 Press **Q/↵**.
- 2 Turn the volume knob to select a list, then press the knob.
- 3 Press **◀◀ / ▶▶** to search at a preset skip search ratio.
  - Pressing and holding **◀◀ / ▶▶** searches at a 10% ratio irregardless of the **[SKIP SEARCH]** settings.
- 4 Turn the volume knob to select a file, then press the knob.  
Selected file starts playing.



## USB/iPod

### [SKIP SEARCH] setting

- 1 Press the volume knob to enter [FUNCTION].
- 2 Turn the volume knob to select [USB], then press the knob.
- 3 Turn the volume knob to select [SKIP SEARCH], then press the knob.
- 4 Turn the volume knob to select the skip search ratio, then press the knob.  
[0.5%] (default)/[1%]/[5%]/[10%]  
The skip search ratio is shown as a percentage of the total files.
- 5 Press and hold **Q/↵** to exit.

### ■ **Alphabet search** (applicable only for iPod USB source and iPod BT source)

You can search for a file according to the first character.

- For iPod, applicable only when [MODE OFF] is selected. (Page 12)

- 1 Press **Q/↵**.
- 2 Turn the volume knob to select a list, then press the knob.
- 3 Turn the volume knob quickly to enter character search.
- 4 Turn the volume knob to select the character.
  - Select "\*" to search for a character other than A to Z, 0 to 9.
- 5 Press **◀/▶** to move to the entry position.
  - You can enter up to 3 characters.
- 6 Press the volume knob to start searching.
- 7 Turn the volume knob to select a file, then press the knob.  
Selected file starts playing.

- To return to the root folder/first file/top menu, press 5. (Not applicable for BT AUDIO source.)
- To return to the previous setting item, press **Q/↵**.
- To cancel, press and hold **Q/↵**.

## Spotify

You can listen to Spotify on iPhone/iPod touch (via Bluetooth or via USB input terminal) or Android device (via Bluetooth) (page 17).

### Preparation:

- Install the latest version of the Spotify application on your device (iPhone/iPod touch or Android device), then create an account and log in to Spotify.
- Select [ON] for [SPOTIFY SRC] in [SOURCE SELECT]. (Page 6)

### Start listening

- 1 Start up the Spotify application on your device.
- 2 Connect your device to the USB input terminal.

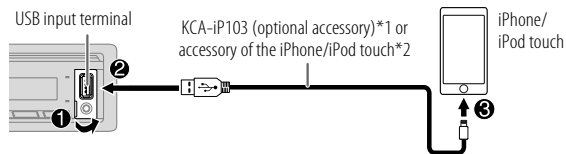







You can also connect the iPhone/iPod touch or Android device via Bluetooth. (Page 17)

- Make sure the USB input terminal is not connected to any device when you connect via Bluetooth.
- 3 Press **⏻ SRC** repeatedly to select SPOTIFY (for iPhone/iPod touch) or SPOTIFY BT (for Android device).  
Broadcast starts automatically.

\*1 KCA-iP103: Lightning type

\*2 Do not leave the cable inside the car when not in use.

## Spotify

| To                                | On the faceplate   |
|-----------------------------------|--|
| Play back/pause                   | Press 6  .  |
| Skip a track                      | Press 1  *3 /  . |
| Select thumbs up or thumbs down*4 | Press 2  / 1  .  |
| Start radio                       | Press and hold 5.  |
| Repeat play*5                     | Press 4  repeatedly.<br>[REPEAT ALL], [REPEAT ONE]*3, [REPEAT OFF]                                |
| Random play*5                     | Press 3  repeatedly*3.<br>[SHUFFLE ON], [SHUFFLE OFF]   |

\*3 Available for premium account users only.

\*4 This feature is available for tracks in Radio only. If thumbs down is selected, the current track is skipped.

\*5 Available for tracks in Playlists only.

### Save favorite song information

While listening to the Radio on Spotify...

**Press and hold the volume knob.**

"SAVED" appears and the information is stored to "Your Music" or "Your Library" on your Spotify account.

To unsave, repeat the same procedure.

"REMOVED" appears and the information is removed from "Your Music" or "Your Library" on your Spotify account.

### Search for a song or station

- 1 Press .
- 2 Turn the volume knob to select a list type, then press the knob. The list types displayed differ depending on the information sent from Spotify.
- 3 Turn the volume knob to select the desired song or station.
- 4 Press the volume knob to confirm. You can browse through the list quickly by turning the volume knob quickly.

To cancel, press and hold .

# AUX

You can listen to music from a portable audio player via the auxiliary input jack.

## Preparation:

Select [ON] for [BUILT-IN AUX] in [SOURCE SELECT]. (Page 6)

## Start listening

- 1 Connect a portable audio player (commercially available).

Auxiliary input jack

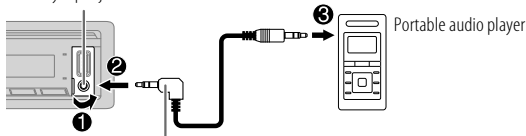

3.5 mm stereo mini plug with "L" shaped connector  
(commercially available)

- 2 Press  $\odot$  SRC repeatedly to select AUX.
- 3 Turn on the portable audio player and start playback.

## Set the name of the external device

While listening to a portable audio player connected to the unit...

- 1 Press the volume knob to enter [FUNCTION].
- 2 Turn the volume knob to select [SYSTEM], then press the knob.
- 3 Turn the volume knob to select [AUX NAME SET], then press the knob.
- 4 Turn the volume knob to select an item, then press the knob.  
[AUX] (default)/[DVD]/[PORTABLE]/[GAME]/[VIDEO]/[TV]
- 5 Press and hold  $\mathcal{R}/\rightarrow$  to exit.

To return to the previous setting item, press  $\mathcal{R}/\rightarrow$ .

# Using Other Applications

## KENWOOD Remote application

You can control the KENWOOD car receiver using KENWOOD Remote application from iPhone/iPod touch (via Bluetooth or via USB input terminal) or Android device (via Bluetooth).

- For more information, visit <http://www.kenwood.com/cs/ce/>.

## Preparation:

Install the latest version of KENWOOD Remote application on your device before connecting.

## Start using KENWOOD Remote application

- 1 Start up the KENWOOD Remote application on your device.
- 2 Connect your device.
  - For Android device:  
Pair the Android device with this unit via Bluetooth. (Page 17)
  - For iPhone/iPod touch:  
Connect iPhone/iPod touch to the USB input terminal. (Page 11)  
(or)  
Pair the iPhone/iPod touch with this unit via Bluetooth. (Page 17)  
(Make sure the USB input terminal is not connected to any device.)
- 3 Select the device to use from the [FUNCTION] menu.  
See "Settings to use KENWOOD Remote application" on page 16.  
By default, [ANDROID] is selected. To use iPhone/iPod touch, select [YES] for [IOS].
  - "R.APP" indicator lights up when KENWOOD Remote application is connected.

## Using Other Applications

### Settings to use KENWOOD Remote application

- 1 Press the volume knob to enter [FUNCTION].
- 2 Turn the volume knob to select an item (see the following table), then press the knob.
- 3 Repeat step 2 until the desired item is selected or activated.
- 4 Press and hold **Q/↵** to exit.

To return to the previous setting item, press **Q/↵**.

Default: **[XX]**

| [REMOTE APP]   |   |
|----------------|---|
| [SELECT]       | Selects the device ([IOS] or [ANDROID]) to use the application.   |
| [IOS]          | <p>[YES]: Selects iPhone/iPod touch to use the application via Bluetooth or connected via USB input terminal. ; [NO]: Cancels.</p> <p>If [IOS] is selected, select iPod BT source (or iPod USB source if your iPhone/iPod touch is connected via USB input terminal) to activate the application.</p> <ul style="list-style-type: none"><li>• The connectivity of the application will be interrupted or disconnected if:<ul style="list-style-type: none"><li>– You change from iPod BT source to any playback source connected via the USB input terminal.</li><li>– You change from iPod USB source to iPod BT source.</li></ul></li></ul> |
| [ANDROID]      | <p>[YES]: Selects Android device to use the application via Bluetooth. ; [NO]: Cancels.</p>   |
| [ANDROID LIST] | <p>Selects the Android device to use from the list.</p> <ul style="list-style-type: none"><li>• Displayed only when [ANDROID] of [SELECT] is set to [YES].</li></ul>  |

[STATUS]

Shows the status of the selected device.

[IOS CONNECTED]: You are able to use the application using the iPhone/iPod touch connected via Bluetooth or USB input terminal.

[IOS NOT CONNECTED]: No iOS device is connected to use the application.

[ANDROID CONNECTED]: You are able to use the application using the Android device connected via Bluetooth.

[ANDROID NOT CONNECTED]: No Android device is connected to use the application.

### TuneIn Radio/TuneIn Radio Pro

While listening to TuneIn Radio or TuneIn Radio Pro, connect the iPhone/iPod touch to the USB input terminal of the unit so that the unit will output the sound from these applications.

# Bluetooth®

- Depending on the Bluetooth version, operating system and the firmware version of your mobile phone, Bluetooth features may not work with this unit.
- Be sure to turn on the Bluetooth function of the device to make the following operations.
- Signal conditions vary depending on the surroundings.

## Bluetooth — Connection

### Supported Bluetooth profiles

- Hands-Free Profile (HFP)
- Advanced Audio Distribution Profile (A2DP)
- Audio/Video Remote Control Profile (AVRCP)
- Serial Port Profile (SPP)
- Phonebook Access Profile (PBAP)

### Supported Bluetooth codecs

- Sub Band Codec (SBC)
- Advanced Audio Coding (AAC)

## Connect the microphone

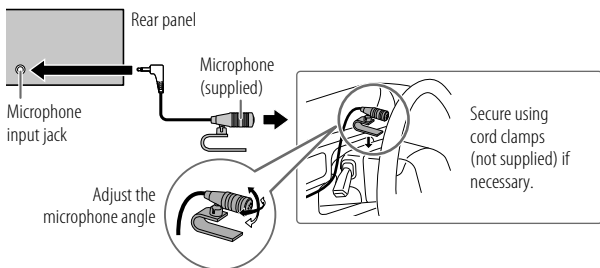

## Pair and connect a Bluetooth device for the first time

- 1 Press **⏻ SRC** to turn on the unit.
- 2 Search and select the name of your receiver ("KMM-BT506DAB") on the Bluetooth device.  
"PAIRING" → "PASS XXXXXX" → "Device name" → "PRESS" → "VOLUME KNOB" appears on the display.
  - For some Bluetooth devices, you may need to enter the Personal Identification Number (PIN) code immediately after searching.
- 3 Press the volume knob to start pairing.  
"PAIRING OK" appears when pairing is completed.

Once pairing is completed, Bluetooth connection is established automatically.

- "BT1" and/or "BT2" indicator on the faceplate lights up.
- "🔋" indicator lights up to show the strength of the battery and signal of the connected device.
- This unit supports Secure Simple Pairing (SSP).
- Up to five devices can be registered (paired) in total.
- Once the pairing is completed, the Bluetooth device will remain registered in the unit even if you reset the unit. To delete the paired device, see **[DEVICE DELETE]** on page 21.
- A maximum of two Bluetooth phones and one Bluetooth audio device can be connected at any time. To connect or disconnect the registered device, see **[PHONE SELECT]** or **[AUDIO SELECT]** in **[BT MODE]**. (Page 21)  
However, while in BT AUDIO source, you can connect to five Bluetooth audio devices and switch between these five devices. (Page 22)
- Some Bluetooth devices may not automatically connect to the unit after pairing. Connect the device to the unit manually.
- Refer to the instruction manual of the Bluetooth device for more information.

## Bluetooth®

### Auto Pairing

When you connect iPhone/iPod touch to the USB input terminal, pairing request (via Bluetooth) is automatically activated if [AUTO PAIRING] is set to [ON]. (Page 21)

Press the volume knob to pair once you have confirmed the device name.

### Bluetooth — Mobile phone

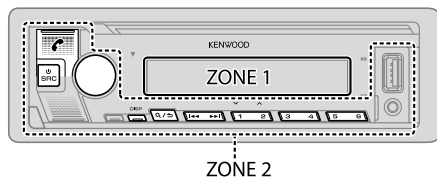

### Receive a call

When there is an incoming call:

- [ZONE 2] illuminates in green color and flashes.
- The unit answers the call automatically if [AUTO ANSWER] is set to a selected time. (Page 19)

During a call:

- [ZONE 1] illuminates according to the settings made for [DISPLAY] (page 29) and [ZONE 2] illuminates in green color.
- If you turn off the unit or detach the faceplate, Bluetooth is disconnected.

The following operations may differ or be unavailable depending on the connected phone.

| To   | On the faceplate   |
|--|--|
| First incoming call...                                 |  |
| Answer a call  | Press  or the volume knob or one of the number buttons (1 to 6). |
| Reject a call  | Press .  |
| End a call   | Press .  |
| While talking on the first incoming call...            |  |
| Answer another incoming call and hold the current call | Press .  |
| Reject another incoming call                           | Press .  |
| While having two active calls...                       |  |
| End current call and activate held call                | Press .  |
| Swap between the current call and held call            | Press .  |
| Adjust the phone volume*1                              | Turn the volume knob during a call.                              |
| [00] to [35] (Default: [15])                           |  |
| Switch between hands-free and private talk modes*2     | Press 6  during a call.  |

\*1 This adjustment will not affect the volume of the other sources.

\*2 Operations may vary according to the connected Bluetooth device.

## Bluetooth®

### ■ Improve the voice quality

While talking on the phone...

- 1 Press the volume knob to enter [FUNCTION].
- 2 Turn the volume knob to select an item (see the following table), then press the knob.
- 3 Repeat step 2 until the desired item is selected or activated.
- 4 Press and hold **Q/↵** to exit.

To return to the previous setting item, press **Q/↵**.

Default: [XX]

|               |  |
|---------------|--|
| [MIC GAIN]    | [LEVEL -10] to [LEVEL +10] ([LEVEL -4]): The sensitivity of the microphone increases as the number increases.                                  |
| [NR LEVEL]    | [LEVEL -5] to [LEVEL +5] ([LEVEL 0]): Adjust the noise reduction level until the least noise is being heard during a phone conversation.       |
| [ECHO CANCEL] | [LEVEL -5] to [LEVEL +5] ([LEVEL 0]): Adjust the echo cancellation delay time until the least echo is being heard during a phone conversation. |

### ■ Make the setting for answering a call

- 1 Press **☎** to enter Bluetooth mode.
- 2 Turn the volume knob to select [SETTINGS], then press the knob.
- 3 Turn the volume knob to select [AUTO ANSWER], then press the knob.
- 4 Turn the volume knob to select the time (in seconds) for the unit to answer the call automatically, then press the knob.  
[01] to [30], or select [OFF] to cancels. (Default: [OFF])
- 5 Press and hold **Q/↵** to exit.

To return to the previous setting item, press **Q/↵**.

### Make a call

You can make a call from the call history, phonebook, or dialing the number. Call by voice is also possible if your mobile phone has the feature.

- 1 Press **☎** to enter Bluetooth mode.  
“(First device name)” appears.
  - If two Bluetooth phones are connected, press **☎** again to switch to the other phone.  
“(Second device name)” appears.
- 2 Turn the volume knob to select an item (see the following table), then press the knob.
- 3 Repeat step 2 until the desired item is selected/activated or follow the instructions stated on the selected item.
- 4 Press and hold **Q/↵** to exit.

To return to the previous setting item, press **Q/↵**.

|                |   |
|----------------|---|
| [CALL HISTORY] | (Applicable only if the phone supports PBAP.) <ol style="list-style-type: none"><li>1 Press the volume knob to select a name or a phone number.<ul style="list-style-type: none"><li>• “I” indicates call received, “O” indicates call made, “M” indicates call missed.</li><li>• Press DISP to change the display category (NUMBER or NAME).</li><li>• “NO DATA” appears if there is no recorded call history or call number.</li></ul></li><li>2 Press the volume knob to call.</li></ol> |
|----------------|---|

- [PHONE BOOK]** (Applicable only if the phone supports PBAP.)
- 1 Turn the volume knob quickly to enter alphabet search mode (if the phonebook contains many contacts).  
The first menu (ABCDEFGHIJK) appears.
    - To go to the other menu (LMNOPQRSTUW or WXYZ1\*), press 2 / 1 .
    - To select the desired first letter, turn the volume knob or press / , then press the knob.  
Select "1" to search with numbers and select "\*" to search with symbols.
  - 2 Turn the volume knob to select a name, then press the knob.
  - 3 Turn the volume knob to select a phone number, then press the knob to call.
    - For using phonebook with this unit, make sure to allow access to or transfer from your smartphone. Depending on the connected phone, the process may be different.
    - Contacts are categorized as: HM (home), OF (office), MO (mobile), OT (other), GE (general)
    - This unit can display only non-accent letters. (Accent letters such as "ú" are shown as "U".)

- [NUMBER DIAL]**
- 1 Turn the volume knob to select a number (0 to 9) or character (\*, #, +).
  - 2 Press / to move the entry position.  
Repeat step 1 and step 2 until you finish entering the phone number.
  - 3 Press the volume knob to call.

**[VOICE]** Speak the name of the contact you want to call or the voice command to control the phone functions. (See also the following "Make a call using voice recognition".)

**[LOW]/[MID]/[FULL]:** Shows the strength of the battery.\*

**[NO SIGNAL]/[LOW]/[MID]/[MAX]:** Shows the strength of the current received signal.\*

\* Functionality depends on the type of the phone used.

## Make a call using voice recognition

- 1 Press and hold to activate the voice recognition of the connected phone.
- 2 Speak the name of the contact you want to call or the voice command to control the phone functions.
  - Supported Voice Recognition features vary for each phone. Refer to the instruction manual of the connected phone for details.

## Store a contact in memory

You can store up to 6 contacts into the number buttons (1 to 6).

- 1 Press to enter Bluetooth mode.
- 2 Turn the volume knob to select [CALL HISTORY], [PHONE BOOK] or [NUMBER DIAL], then press the knob.
- 3 Turn the volume knob to select a contact or enter a phone number.  
If a contact is selected, press the volume knob to show the phone number.
- 4 Press and hold one of the number buttons (1 to 6).  
"STORED" appears when the contact is stored.

To erase a contact from the preset memory, select [NUMBER DIAL] in step 2, store a blank number in step 3 and proceed to step 4.

## Make a call to a registered number

- 1 Press to enter Bluetooth mode.
- 2 Press one of the number buttons (1 to 6).
- 3 Press the volume knob to call.  
"NO MEMORY" appears if there is no contact stored.



## Bluetooth®

### Bluetooth mode settings

- 1 Press the volume knob to enter [FUNCTION].
- 2 Turn the volume knob to select an item (see the following table), then press the knob.
- 3 Repeat step 2 until the desired item is selected/activated or follow the instructions stated on the selected item.
- 4 Press and hold **Q**/**S** to exit.

To return to the previous setting item, press **Q**/**S**.

Default: **[XX]**

| [BT MODE]                 |   |
|---------------------------|---|
| [PHONE SELECT]            | Selects the phone or audio device to connect or disconnect.<br>“✖” appears in front of the device name when connected.  |
| [AUDIO SELECT]            | “▷” appears in front of the current playback audio device.<br>• You can connect a maximum of two Bluetooth phones and one Bluetooth audio device at a time.   |
| [DEVICE DELETE]           | <ol style="list-style-type: none"><li>1 Turn the volume knob to select a device to delete, then press the knob.</li><li>2 Turn the volume knob to select <b>[YES]</b> or <b>[NO]</b>, then press the knob.</li></ol>  |
| [PIN CODE EDIT]<br>(0000) | Changes the PIN code (up to 6 digits).<br><ol style="list-style-type: none"><li>1 Turn the volume knob to select a number.</li><li>2 Press <b>←←</b> / <b>→→</b> to move the entry position.<br/>Repeat step 1 and step 2 until you finish entering the PIN code.</li><li>3 Press the volume knob to confirm.</li></ol> |
| [RECONNECT]               | <b>[ON]</b> : The unit is automatically reconnect when the last connected Bluetooth device is within the connectable range. ; <b>[OFF]</b> : Cancels.   |
| [AUTO PAIRING]            | <b>[ON]</b> : The unit is automatically paired with the supported Bluetooth device (iPhone/iPod touch) when it is connected through USB input terminal. Depending on the operating system of the connected device, this function may not work. ; <b>[OFF]</b> : Cancels.  |

**[INITIALIZE]**

**[YES]**: Initializes all the Bluetooth settings (including stored pairing, phonebook, and etc.). ; **[NO]**: Cancels.

### Bluetooth test mode

You can check the connectivity of the supported profile between the Bluetooth device and the unit.

- Make sure there is no Bluetooth device paired.

- 1 **Press and hold** **↻**.  
“PLEASE PAIR YOUR PHONE PIN 0000” appears on the display.
- 2 **Search and select the name of your receiver (“KMM-BT506DAB”) on the Bluetooth device.**
- 3 **Operate the Bluetooth device to confirm pairing.**  
“TESTING” flashes on the display.

#### The connectivity result (OK or NG) appears after the test.

PAIRING: Pairing status

HF CNT: Hands-Free Profile (HFP) compatibility

AUD CNT: Advanced Audio Distribution Profile (A2DP) compatibility

PB DL: Phonebook Access profile (PBAP) compatibility

To cancel test mode, press and hold **↻**SRC to turn off the unit.

## Bluetooth®

### Bluetooth — Audio

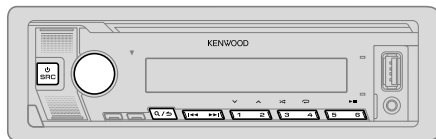

While in BT AUDIO source, you can connect to five Bluetooth audio devices and switch between these five devices.

#### Listen to the audio player via Bluetooth

- 1 Press SRC repeatedly to select BT AUDIO.
- 2 Operate the audio player via Bluetooth to start playback.

| To                        | On the faceplate  |
|---------------------------|---|
| Play back/pause           | Press 6 .   |
| Select group or folder    | Press 2  / 1 .  |
| Reverse skip/Forward skip | Press 1  / .  |
| Reverse/Fast-forward      | Press and hold 1  / .   |
| Repeat play               | Press 4  repeatedly.<br>[ALL REPEAT], [FILE REPEAT], [GROUP REPEAT]*,<br>[REPEAT OFF]                 |
| Random play               | Press and hold 3  to select [ALL RANDOM]<br>or [GROUP RANDOM]*.<br>• Press 3  to select [RANDOM OFF]. |

| To   | On the faceplate  |
|--|---|
| Select a file from a folder/list                 | Refer to "Select a file to play" on page 12.  |
| Switch between connected Bluetooth audio devices | Press 5.<br>(Pressing the "Play" key on the connected device itself also causes switching of sound output from the device.) |

\* Depending on the connected device, some devices may not support this feature.

Operations and display indications may differ according to their availability on the connected device.

#### Listen to iPod/iPhone via Bluetooth

You can listen to the songs on the iPod/iPhone via Bluetooth on this unit.

Press SRC repeatedly to select iPod BT.

- You can operate the iPod/iPhone in the same way as iPod/iPhone via USB input terminal. (Page 11)
- If you plug in an iPod/iPhone to the USB input terminal while listening to iPod BT source, the source automatically changes to iPod USB source. Press SRC to select iPod BT source if the device is still connected via Bluetooth.

# AMAZON ALEXA

Alexa is the cloud-based voice service developed by Amazon. You can ask Alexa to play music, get weather reports, traffic information, control smart home devices, shop on Amazon, search the internet, set reminders and more.

## Preparation:

- Create an account at <[www.amazon.com](http://www.amazon.com)>.
- Install the latest version of the Alexa mobile application on your device (iPhone/iPod touch or Android device), then log in to the application.
- Be sure to enable the internet connection on your smartphone.

## Setup for the first time

### For Android device

- 1 Pair your device with this unit via Bluetooth. (Page 17)
- 2 Start up the Alexa mobile application on your device.
- 3 Pair this unit to Alexa mobile application.  
Perform Option A or Option B.

### For iPhone/iPod touch

- 1 Pair your device with this unit via Bluetooth. (Page 17)
- 2 Start up the Alexa mobile application on your device.
- 3 Press **O** on the unit to enter ALEXA source.
  - You may also press **SRC** repeatedly to select iPod BT source.
- 4 Pair this unit to Alexa mobile application.  
Perform Option A or Option B.

### Option A: Direct Link

Access the following URL or scan the QR code with your smartphone:

<https://www.kenwood.com/car/alexa>



### Option B: Manual Pairing

- 1 Start up the Alexa mobile application and go to the "Devices" tab.
- 2 Tap the "+" icon at the top right corner.

3 Tap "Add Device".

4 Tap "Automotive Accessory" or "Headphones" from the list of device types.

5 Tap the name of your receiver ("KMM-BT506DAB") and follow the instructions.

Once the setup process is completed, the Alexa mobile application will establish a connection with this unit.

- The Alexa connection can be disconnected if:
  - A2DP profile is disconnected
  - Bluetooth is disconnected
  - This unit is turned off
  - Any other conditions depending on the connected device.To establish Alexa connection again, reconnect the A2DP profile.
- Alexa connection cannot be established again if you:
  - Reinstall Alexa mobile application
  - Delete the paired device and perform pairing again (for Android device)To establish Alexa connection again, perform the setup process again.
- You can check the Alexa connection from the Alexa mobile application. If the name of this unit appears on the screen of "ALL DEVICES", you do not need to perform setup process again.

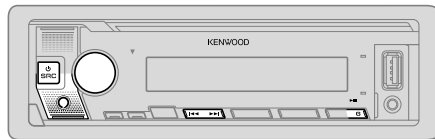

## Basic operations

Once Alexa connection is established...

- 1 Press **O** on the unit to speak with Alexa.  
The display shows: "ALEXA" → "LISTENING..."

## AMAZON ALEXA

### 2 Communicate with Alexa via the connected microphone. (Page 17)

"THINKING..." appears when Alexa is processing your voice input.  
"SPEAKING..." appears while Alexa is responding to your voice input.  
"ALEXA" or display information such as playing time, song title, etc. appears while Alexa is in idle state.

- To return to the previous source before ALEXA, press **SRC**.
- To activate Alexa, press **O**.
- To cancel current listening state, press **O**.
- To cancel current thinking/speaking states and go to listening state, press **O**.
- Only one Alexa connection can be connected at one time.
- "DISCONNECTED" appears if the unit is disconnected from Alexa mobile application or the Bluetooth connection is disconnected.

### Start listening

While in Alexa idle state...

- 1 Press **O** on the unit to activate Alexa.  
The display shows: "LISTENING...".
- 2 Communicate with Alexa via the connected microphone. (Page 17)
- 3 During music playback in ALEXA source, you can perform the following operations:

| To                        | On the faceplate                       |
|---------------------------|--|
| Play back/pause           | Press <b>6</b> <b>▶  </b> .            |
| Reverse skip/Forward skip | Press <b>1</b> <b>◀◀</b> / <b>▶▶</b> . |

During music playback, press **O** to pause the music and activate Alexa. You can now start to communicate with Alexa.

## Audio Settings

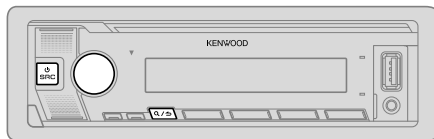

- 1 Press the volume knob to enter [FUNCTION].
- 2 Turn the volume knob to select an item (see the following table), then press the knob.
- 3 Repeat step 2 until the desired item is selected or activated.
- 4 Press and hold **Q/↵** to exit.

To return to the previous setting item, press **Q/↵**.

Default: **[XX]**

| [AUDIO CONTROL] |  |
|-----------------|--|
| [SUB-W LEVEL]   | [LEVEL -50] to [LEVEL +10] ([LEVEL 0]): Adjusts the subwoofer output level.  |
| [EASY EQ]       | Adjusts your own sound settings. <ul style="list-style-type: none"><li>• The settings are stored to [USER] in [PRESET EQ].</li><li>• The settings made may affect the current settings of [MANUAL EQ].</li></ul> |
| [SW]:           | [LEVEL -50] to [LEVEL +10] (Default: [LEVEL 0])  |
| [BASS]:         | [LEVEL -9] to [LEVEL +9] [LEVEL +1]  |
| [MID]:          | [LEVEL -9] to [LEVEL +9] [LEVEL -6]  |
| [TRE]:          | [LEVEL -9] to [LEVEL +9] [LEVEL +3]  |

## Audio Settings

|  |  |
|--|--|
| [MANUAL EQ]  | Adjusts your own sound settings for each source.<br>• The settings are stored to [USER] in [PRESET EQ].<br>• The settings made may affect the current settings of [EASY EQ].   |
| [62.5HZ]   | [LEVEL] [LEVEL -9] to [LEVEL +9] ([LEVEL +5]): Adjusts the level to memorize for each source.<br>(Before making an adjustment, select the source you want to adjust.)  |
| [BASS EXTEND]  | [ON]: Turns on the extended bass. ; [OFF]: Cancels.  |
| [100HZ]/[160HZ]/<br>[250HZ]/[400HZ]/<br>[630HZ]/[1KHZ]/<br>[1.6KHZ]/[2.5KHZ]/<br>[4KHZ]/[6.3KHZ]/<br>[10KHZ]/[16KHZ] | Adjusts the level to memorize for each source.<br>(Before making an adjustment, select the source you want to adjust.)<br>[100HZ]: [LEVEL -9] to [LEVEL +9] (Default: [LEVEL +1])<br>[160HZ]: [LEVEL -9] to [LEVEL +9] [LEVEL 0]<br>[250HZ]: [LEVEL -9] to [LEVEL +9] [LEVEL -1]<br>[400HZ]: [LEVEL -9] to [LEVEL +9] [LEVEL -2]<br>[630HZ]: [LEVEL -9] to [LEVEL +9] [LEVEL -3]<br>[1KHZ]: [LEVEL -9] to [LEVEL +9] [LEVEL -6]<br>[1.6KHZ]: [LEVEL -9] to [LEVEL +9] [LEVEL -3]<br>[2.5KHZ]: [LEVEL -9] to [LEVEL +9] [LEVEL -2]<br>[4KHZ]: [LEVEL -9] to [LEVEL +9] [LEVEL -4]<br>[6.3KHZ]: [LEVEL -9] to [LEVEL +9] [LEVEL +4]<br>[10KHZ]: [LEVEL -9] to [LEVEL +9] [LEVEL +3]<br>[16KHZ]: [LEVEL -9] to [LEVEL +9] [LEVEL +7]) |
| [Q FACTOR]   | [1.35]/[1.50]/[2.00]: Adjusts the quality factor.  |
| [PRESET EQ]  | [NATURAL]/[ROCK]/[POPS]/[EASY]/[TOP40]/[JAZZ]/[POWERFUL]/<br>[USER]: Selects a preset equalizer suitable to the music genre.<br>(Select [USER] to use the settings made in [EASY EQ] or [MANUAL EQ].)  |
| [BASS BOOST]   | [LV1] to [LV5]: Selects your preferred bass boost level. ; [OFF]: Cancels.   |
| [LOUDNESS]   | [LV1]/[LV2]: Selects your preferred low or high frequencies boost to produce a well-balanced sound at low volume. ; [OFF]: Cancels.  |
| [SUBWOOFER SET]  | [ON]: Turns on the subwoofer output. ; [OFF]: Cancels.   |
| [FADER]  | (Not applicable if 3-way crossover is selected.)<br>[R15] to [F15] ([0]): Adjusts the front and rear speaker output balance.   |
| [BALANCE]  | [L15] to [R15] ([0]): Adjusts the left and right speaker output balance.   |
| [VOLUME OFFSET]  | [-15] to [+6] ([0]): Presets the initial volume level of each source by comparing to the FM volume level.<br>(Before adjustment, select the source you want to adjust.)  |
| [SOUND EFFECT]   |  |
| [SOUND RECNRSTR]<br>(Sound reconstruction)   | (Not applicable for RADIO source, DIGITAL AUDIO source and AUX source.)<br>[ON]: Creates realistic sound by compensating the high-frequency components and restoring the rise-time of the waveform that are lost in audio data compression. ; [OFF]: Cancels.  |
| [SPACE ENHANCE]  | (Not applicable for RADIO source and DIGITAL AUDIO source.)<br>[SML]/[MED]/[LRG]: Virtually enhances the sound space. ; [OFF]: Cancels.  |
| [SND REALIZER]   | [LV1]/[LV2]/[LV3]: Virtually makes the sound more realistic. ; [OFF]: Cancels.   |
| [STAGE EQ]   | [LOW]/[MID]/[HI]: Virtually adjusts the sound position heard from the speakers. ; [OFF]: Cancels.  |
| [DRIVE EQ]   | [ON]: Boosts the frequency to reduce the noise heard from outside the car or running noise of the tyres. ; [OFF]: Cancels.   |
| [SPEAKER SIZE]   | Depending on the crossover type you have selected (see "Change the crossover type" on page 6), 2-way crossover or 3-way crossover setting items will be shown. (See "Crossover settings" on page 26.)<br>By default, 2-way crossover type is selected.   |
| [X ' OVER]   |  |
| [DTA SETTINGS]   | For settings, see "Digital Time Alignment settings" on page 27.  |
| [CAR SETTINGS]   |  |
|  | • [SUB-W LEVEL] is selectable only when [SUBWOOFER SET] is set to [ON].  |

## Audio Settings

### Crossover settings

Below are the available setting items for 2-way crossover and 3-way crossover.

#### SPEAKER SIZE

Selects according to the connected speaker size for optimum performance.

- The frequency and slope settings are automatically set for the crossover of the selected speaker.
- If [NONE] is selected for the following speaker in [SPEAKER SIZE], the [X'OVER] setting of the selected speaker is not available.
  - 2-way crossover: [TWEETER] of [FRONT]/[REAR]/[SUBWOOFER]
  - 3-way crossover: [WOOFER]

#### X'OVER (crossover)

- [FRQ]/[F-HPF FRQ]/[R-HPF FRQ]/[SW LPF FRQ]/[HPF FRQ]/[LPF FRQ]: Adjusts the crossover frequency for the selected speakers (high pass filter or low pass filter).  
If [THROUGH] is selected, all signals are sent to the selected speakers.
- [SLOPE]/[F-HPF SLOPE]/[R-HPF SLOPE]/[SW LPF SLOPE]/[HPF SLOPE]/[LPF SLOPE]: Adjusts the crossover slope.  
Selectable only if a setting other than [THROUGH] is selected for the crossover frequency.
- [SW LPF PHASE]/[PHASE]: Selects the phase of the speaker output to be in line with the other speaker output.
- [GAIN LEFT]/[GAIN RIGHT]/[F-HPF GAIN]/[R-HPF GAIN]/[SW LPF GAIN]/[GAIN]: Adjusts the output volume of the selected speaker.

### 2-way crossover setting items

| [SPEAKER SIZE] |               |  |
|----------------|---------------|--|
| [FRONT]        | [SIZE]        | [8CM]/[10CM]/[12CM]/[13CM]/[16CM]/[17CM]/[18CM]/[4×6]/[5×7]/[6×8]/[6×9]/[7×10]                             |
|                | [TWEETER]     | [SMALL]/[MIDDLE]/[LARGE]/[NONE]<br>(not connected)   |
| [REAR]         |               | [8CM]/[10CM]/[12CM]/[13CM]/[16CM]/[17CM]/[18CM]/[4×6]/[5×7]/[6×8]/[6×9]/[7×10]/[NONE] (not connected)      |
| [SUBWOOFER]    |               | [16CM]/[20CM]/[25CM]/[30CM]/[38CM OVER]/[NONE]<br>(not connected)  |
| [X'OVER]       |               |  |
| [TWEETER]      | [FRQ]         | [1KHZ]/[1.6KHZ]/[2.5KHZ]/[4KHZ]/[5KHZ]/[6.3KHZ]/[8KHZ]/[10KHZ]/[12.5KHZ]                                   |
|                | [GAIN LEFT]   | [–8] to [0]  |
|                | [GAIN RIGHT]  | [–8] to [0]  |
| [FRONT HPF]    | [F-HPF FRQ]   | [30HZ]/[40HZ]/[50HZ]/[60HZ]/[70HZ]/[80HZ]/[90HZ]/[100HZ]/[120HZ]/[150HZ]/[180HZ]/[220HZ]/[250HZ]/[THROUGH] |
|                | [F-HPF SLOPE] | [–6DB]/[–12DB]/[–18DB]/[–24DB]   |
|                | [F-HPF GAIN]  | [–8] to [0]  |
| [REAR HPF]     | [R-HPF FRQ]   | Configure the settings for the rear speakers similarly to the front speakers.                              |
|                | [R-HPF SLOPE] |  |
|                | [R-HPF GAIN]  |  |

## Audio Settings

|                 |                |  |
|-----------------|----------------|--|
| [SUBWOOFER LPF] | [SW LPF FRQ]   | [30HZ]/[40HZ]/[50HZ]/[60HZ]/[70HZ]/[80HZ]/[90HZ]/[100HZ]/[120HZ]/[150HZ]/[180HZ]/[220HZ]/[250HZ]/[THROUGH] |
|                 | [SW LPF SLOPE] | [−6DB]/[−12DB]/[−18DB]/[−24DB]   |
|                 | [SW LPF PHASE] | [REVERSE] (180°)/[NORMAL] (0°)   |
|                 | [SW LPF GAIN]  | [−8] to [0]  |

- [SUBWOOFER] of [SPEAKER SIZE] and [SUBWOOFER LPF] of [X'OVER] is selectable only when [SUBWOOFER SET] is set to [ON]. (Page 25)

### 3-way crossover setting items

|                |           |  |
|----------------|-----------|--|
| [SPEAKER SIZE] |           |  |
| [TWEETER]      |           | [SMALL]/[MIDDLE]/[LARGE]   |
| [MID RANGE]    |           | [8CM]/[10CM]/[12CM]/[13CM]/[16CM]/[17CM]/[18CM]/[4×6]/[5×7]/[6×8]/[6×9]  |
| [WOOFER]       |           | [16CM]/[20CM]/[25CM]/[30CM]/[38CM OVER]/[NONE] (not connected)           |
| [X'OVER]       |           |  |
| [TWEETER]      | [HPF FRQ] | [1KHZ]/[1.6KHZ]/[2.5KHZ]/[4KHZ]/[5KHZ]/[6.3KHZ]/[8KHZ]/[10KHZ]/[12.5KHZ] |
|                | [SLOPE]   | [−6DB]/[−12DB]   |
|                | [PHASE]   | [REVERSE] (180°)/[NORMAL] (0°)   |
|                | [GAIN]    | [−8] to [0]  |

|             |             |  |
|-------------|-------------|--|
| [MID RANGE] | [HPF FRQ]   | [30HZ]/[40HZ]/[50HZ]/[60HZ]/[70HZ]/[80HZ]/[90HZ]/[100HZ]/[120HZ]/[150HZ]/[180HZ]/[220HZ]/[250HZ]/[THROUGH] |
|             | [HPF SLOPE] | [−6DB]/[−12DB]   |
|             | [LPF FRQ]   | [1KHZ]/[1.6KHZ]/[2.5KHZ]/[4KHZ]/[5KHZ]/[6.3KHZ]/[8KHZ]/[10KHZ]/[12.5KHZ]/[THROUGH]                         |
|             | [LPF SLOPE] | [−6DB]/[−12DB]   |
|             | [PHASE]     | [REVERSE] (180°)/[NORMAL] (0°)   |
|             | [GAIN]      | [−8] to [0]  |
| [WOOFER]    | [LPF FRQ]   | [30HZ]/[40HZ]/[50HZ]/[60HZ]/[70HZ]/[80HZ]/[90HZ]/[100HZ]/[120HZ]/[150HZ]/[180HZ]/[220HZ]/[250HZ]/[THROUGH] |
|             | [SLOPE]     | [−6DB]/[−12DB]   |
|             | [PHASE]     | [REVERSE] (180°)/[NORMAL] (0°)   |
|             | [GAIN]      | [−8] to [0]  |

- [WOOFER] of [SPEAKER SIZE] and [WOOFER] of [X'OVER] is selectable only when [SUBWOOFER SET] is set to [ON]. (Page 25)

### Digital Time Alignment settings

Digital Time Alignment sets the delay time of the speaker output to create a more suitable environment for your vehicle.

- For more information, see “Determining the delay time automatically” on page 28.

## Audio Settings

|  |   |
|--|---|
| <b>[DTA SETTINGS]</b>  |   |
| <b>[POSITION]</b>  | Selects your listening position (reference point).<br><b>[ALL]</b> : Not compensating ; <b>[FRONT RIGHT]</b> : Front right seat ;<br><b>[FRONT LEFT]</b> : Front left seat ; <b>[FRONT ALL]</b> : Front seats<br><ul style="list-style-type: none"> <li><b>[FRONT ALL]</b> is displayed only when <b>[2-WAY X'OVER]</b> is selected. (Page 6)</li> </ul>  |
| <b>[DISTANCE]</b>  | <b>[OCM]</b> to <b>[610CM]</b> : Fine adjust the distance to compensate. (Before making an adjustment, select the speaker you want to adjust.)  |
| <b>[GAIN]</b>  | <b>[-8DB]</b> to <b>[0DB]</b> : Fine adjust the output volume of the selected speaker. (Before making an adjustment, select the speaker you want to adjust.)  |
| <b>[DTA RESET]</b>   | <b>[YES]</b> : Resets the settings ( <b>[DISTANCE]</b> and <b>[GAIN]</b> ) of the selected <b>[POSITION]</b> to default. ; <b>[NO]</b> : Cancels.   |
| <b>[CAR SETTINGS]</b>  |   |
| Identify your car type and rear speaker location in order to make the adjustment for <b>[DTA SETTINGS]</b> . |   |
| <b>[CAR TYPE]</b>  | <b>[COMPACT]/[FULL SIZE CAR]/[WAGON]/[MINIVAN]/[SUV]/[MINIVAN(LONG)]</b> : Selects the type of vehicle. ;<br><b>[OFF]</b> : Not compensating.   |
| <b>[R-SP LOCATION]</b>   | Selects the location of the rear speakers in your vehicle to calculate the furthest distance from the listening position selected (reference point).<br><ul style="list-style-type: none"> <li><b>[DOOR]/[REAR DECK]</b>: Selectable only when <b>[CAR TYPE]</b> is selected as <b>[OFF]</b>, <b>[COMPACT]</b>, <b>[FULL SIZE CAR]</b>, <b>[WAGON]</b> or <b>[SUV]</b>.</li> <li><b>[2ND ROW]/[3RD ROW]</b>: Selectable only when <b>[CAR TYPE]</b> is selected as <b>[MINIVAN]</b> or <b>[MINIVAN(LONG)]</b>.</li> </ul> |

- Before making an adjustment for **[DISTANCE]** and **[GAIN]** of **[DTA SETTINGS]**, select the speaker you want to adjust:

When 2-way crossover is selected:

**[FRONT LEFT]/[FRONT RIGHT]/[REAR LEFT]/[REAR RIGHT]/[SUBWOOFER]**

- You can only select **[REAR LEFT]**, **[REAR RIGHT]** and **[SUBWOOFER]** if a setting other than **[NONE]** is selected for **[REAR]** and **[SUBWOOFER]** of **[SPEAKER SIZE]**. (Page 26)

When 3-way crossover is selected:

**[TWEETER LEFT]/[TWEETER RIGHT]/[MID LEFT]/[MID RIGHT]/[WOOFER]**

- You can only select **[WOOFER]** if a setting other than **[NONE]** is selected for **[WOOFER]** of **[SPEAKER SIZE]**. (Page 27)
- **[R-SP LOCATION]** of **[CAR SETTINGS]** is selectable only if:
  - 2-way crossover is selected. (Page 6)
  - A setting other than **[NONE]** is selected for **[REAR]** of **[SPEAKER SIZE]**. (Page 26)

### Determining the delay time automatically

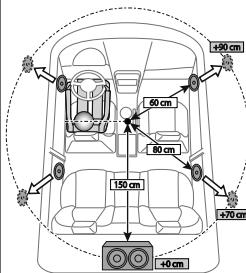

If you specify the distance from the currently set listening position to every speaker, the delay time will be automatically calculated.

- 1 Set **[POSITION]** and determine the listening position as the reference point (the reference point for **[FRONT ALL]** will be the center between the right and left in the front seats).
- 2 Measure the distances from the reference point to the speakers.
- 3 Calculate the distance between the furthest speaker (subwoofer on the illustration) and other speakers.
- 4 Sets the **[DISTANCE]** calculated in step 3 for individual speakers.
- 5 Adjusts **[GAIN]** for individual speakers.

Example: When **[FRONT ALL]** is selected as the listening position.



# Display Settings

Zone identification for color settings and brightness settings

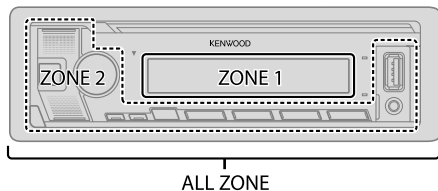

## Set the dimmer

Press and hold DISP to turn on or off the dimmer.

- Once you press and hold this button, [DIMMER] setting will be overwritten.

## Change the display settings

- 1 Press the volume knob to enter [FUNCTION].
- 2 Turn the volume knob to select an item (see the following table), then press the knob.
- 3 Repeat step 2 until the desired item is selected/activated or follow the instructions stated on the selected item.
- 4 Press and hold **Q/S** to exit.

To return to the previous setting item, press **Q/S**.

Default: [XX]

### [DISPLAY]

[COLOR SELECT] Selects illumination colors for [ALL ZONE], [ZONE 1] and [ZONE 2] separately.

- 1 Select a zone. (See the illustration on left column.)
- 2 Select a preset color for the selected zone. (Page 30)  
Default: [VARIABLE SCAN]

To make your own color, select [CUSTOM R/G/B]. The color you have made will be stored in [CUSTOM R/G/B].

- 1 Press the volume knob to enter the detailed color adjustment.
- 2 Press **◀▶** to select the color ([R]/[G]/[B]) to adjust.
- 3 Turn the volume knob to adjust the level ([0] to [9]), then press the knob.

### [DIMMER]

Dims the illumination.

[ON]: Dimmer is turned on.

[OFF]: Dimmer is turned off.

[DIMMER TIME]: Set the time to turn on dimmer and to turn off dimmer.

- 1 Turn the volume knob to adjust the [ON] time, then press the knob.
- 2 Turn the volume knob to adjust the [OFF] time, then press the knob.  
Default: [ON]: [PM6:00] ; [OFF]: [AM6:00]

### [BRIGHTNESS]

Sets the brightness for day and night separately.

- 1 [DAY]/[NIGHT]: Select day or night.
- 2 Select a zone. (See the illustration on left column.)
- 3 [LVL00] to [LVL31]: Set the brightness level.

### [TEXT SCROLL]

[ONCE]: Scrolls the display information once. ; [AUTO]: Repeats scrolling at 5-second intervals. ; [OFF]: Cancels.

- Not applicable to Dynamic Label display information (page 38) while in DIGITAL AUDIO source.

## Display Settings

**[LEVEL METER]** **[ON]:** Shows the level meter on the display window (as shown below). ; **[OFF]:** Cancels.



Level meter

**[CLOCK]**

**[CLOCK DISPLAY]** **[ON]:** The clock time is shown on the display even when the unit is turned off. ; **[OFF]:** Cancels.

**[DEMO MODE]** **[ON]:** Activates the display demonstration automatically if no operation is done for about 15 seconds. ; **[OFF]:** Deactivates.

### Preset color:

[INITIAL COLOR]/[VARIABLE SCAN]/[CUSTOM R/G/B]/[RED1]/[RED2]/[RED3]/[PURPLE1]/[PURPLE2]/[PURPLE3]/[PURPLE4]/[BLUE1]/[BLUE2]/[BLUE3]/[SKYBLUE1]/[SKYBLUE2]/[LIGHTBLUE]/[AQUA1]/[AQUA2]/[GREEN1]/[GREEN2]/[GREEN3]/[YELLOWGREEN1]/[YELLOWGREEN2]/[YELLOW]/[ORANGE1]/[ORANGE2]/[ORANGERED]

## Installation/Connection

This section is for the professional installer.  
For safety's sake, leave wiring and mounting to professionals. Consult the car audio dealer.

### ▲ WARNING

- The unit can only be used with a 12 V DC power supply, negative ground.
- Disconnect the battery's negative terminal before wiring and mounting.
- Do not connect Battery wire (yellow) and Ignition wire (red) to the car chassis or Ground wire (black) to prevent a short circuit.
- To prevent short circuit:
  - Insulate unconnected wires with vinyl tape.
  - Be sure to ground this unit to the car's chassis again after installation.
  - Secure the wires with cable clamps and wrap vinyl tape around the wires that comes into contact with metal parts to protect the wires.

### ▲ CAUTION

- Install this unit in the console of your vehicle. Do not touch the metal parts of this unit during and shortly after use of the unit. Metal parts such as the heat sink and enclosure become hot.
- Do not connect the ⊖ wires of speakers to the car chassis or Ground wire (black), or connect them in parallel.
- Mount the unit at an angle of less than 30°.
- If your vehicle wiring harness does not have the ignition terminal, connect Ignition wire (red) to the terminal on the vehicle's fuse box which provides 12 V DC power supply and is turned on and off by the ignition key.
- Keep all cables away from heat dissipate metal parts.
- After the unit is installed, check whether the brake lamps, blinkers, wipers, etc. on the car are working properly.
- If the fuse blows, first make sure the wires are not touching car's chassis, then replace the old fuse with one that has the same rating.

## Installation/Connection

### Part list for installation

(A) Faceplate (×1)



(B) Trim plate (×1)



(C) Mounting sleeve (×1)

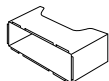

(D) Wiring harness (×1)

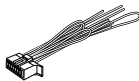

(E) Extraction key (×2)



### Basic procedure

- 1 Remove the key from the ignition switch, then disconnect the  $\ominus$  terminal of the car battery.
- 2 Install the DAB antenna.  
See "Installing the DAB antenna" on page 34.
- 3 Connect the wires properly.  
See "Wiring connection" on page 33.
- 4 Install the unit to your car.  
See the following "Installing the unit (in-dash mounting)".
- 5 Connect the  $\ominus$  terminal of the car battery.
- 6 Press  $\odot$  SRC to turn on the power.
- 7 Detach the faceplate and reset the unit within 5 seconds. (Page 4)

### Installing the unit (in-dash mounting)

1

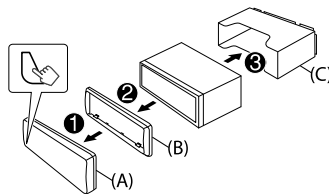

2

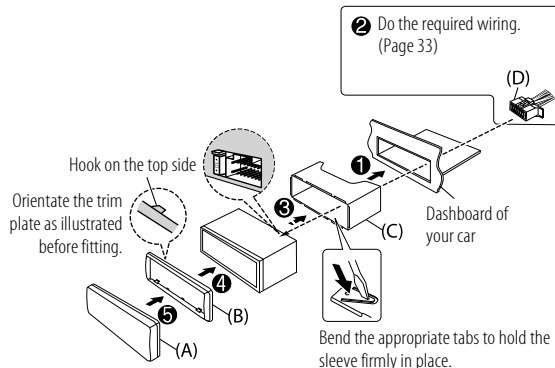

## Installation/Connection

### Installing the unit (without mounting sleeve)

- 1 Remove the mounting sleeve and trim plate from the unit.
- 2 Align the holes in the unit (on both sides) with the vehicle mounting bracket and secure the unit with screws (commercially available).

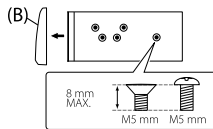

▲ Use only the specified screws. Using wrong screws might damage the unit.

### Removing the unit

- 1 Detach the faceplate.
- 2 Remove the trim plate.
- 3 Insert the extraction keys deeply into the slots on each side, then follow the arrows as shown on the illustration.

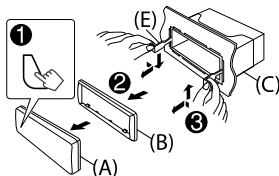

### Connect external components

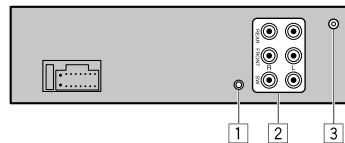

#### No Part

- |   |  |
|---|--|
| 1 | Microphone input jack (Page 17)  |
| 2 | Output terminals (See the following "Connect external amplifiers via output terminals".) |
| 3 | DAB antenna jack (Page 7, 36)  |

### Connect external amplifiers via output terminals

When connecting an external amplifier to the output terminals of this unit, securely connect the amplifier ground wire to the car chassis to prevent damage to the unit.

| Output terminals | 2-way crossover  | 3-way crossover  |
|------------------|------------------|------------------|
| REAR:            | Rear output      | Tweeter output   |
| FRONT:           | Front output     | Mid Range output |
| SW:              | Subwoofer output | Woofer output    |

## Installation/Connection

### Wiring connection

#### IMPORTANT

We recommend installing the unit with a commercially available custom wiring harness specific for your car and leave this job to professionals for your safety. Consult your car audio dealer.

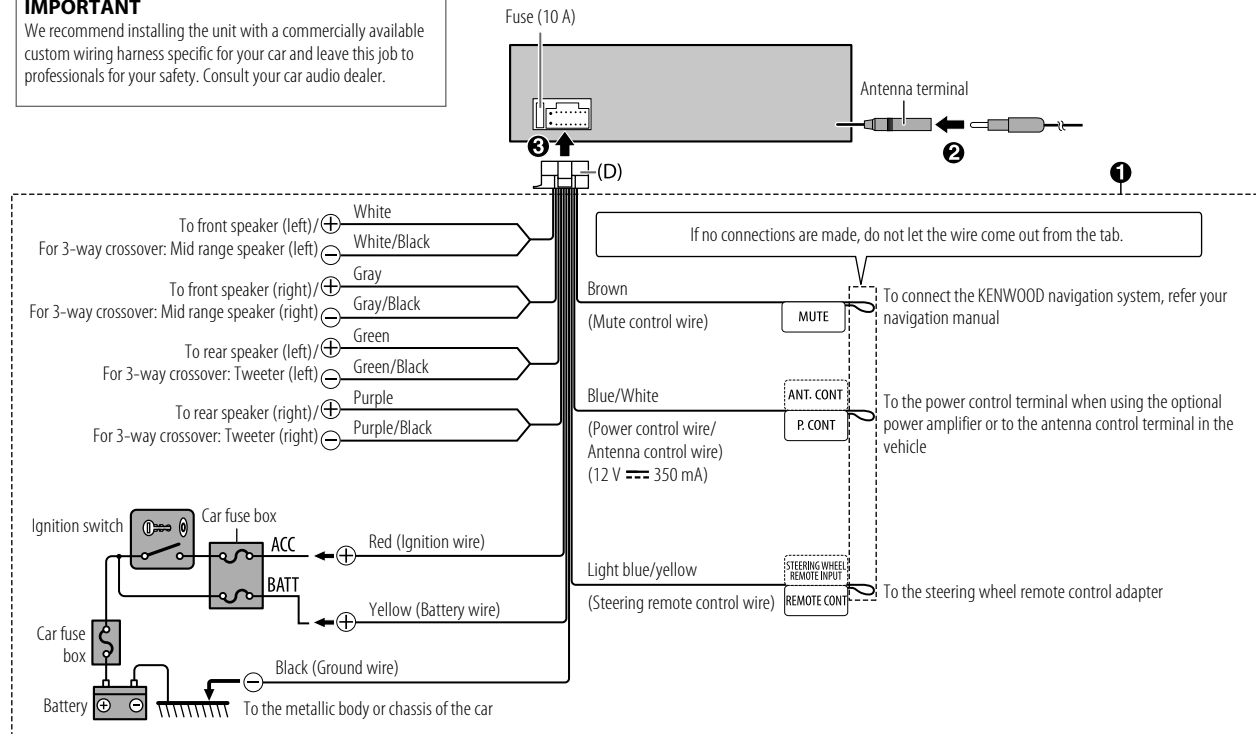

## Installation/Connection

### Installing the DAB antenna

Connect the supplied DAB antenna to the DAB antenna jack. (Page 32)

#### ▲ CAUTION

- The film antenna (F) is exclusively for use inside the vehicle.
- Do not install at the following locations:
  - where it may block the driver's view.
  - where it may obstruct the operation of safety devices such as air bags.
  - on movable glass surfaces such as the rear hatch.
  - at side of vehicle (e.g. door, front quarter window).
  - on rear window.
- Signal strength will weaken when installed at the following locations:
  - on IR reflecting glass or locations covered with mirror type glass film.
  - where it overlaps with genuine radio antenna (pattern).
  - where it overlaps with window heating wires.
  - on glass that blocks radio signals (e.g. IR reflecting glass, thermal insulation glass).
- Poor reception may occur:
  - due to noise when windscreen wiper, air conditioner, or motor is turned on.
  - depending on the direction of the broadcast station with respect to the vehicle (antenna).
- Thoroughly wipe oil and dirt from the pasting surface with the supplied cleaner (I).
- Do not bend or damage the film antenna (F).
- It may not be possible to install on certain vehicles.
- Check the cable routing of the film antenna (F) and amplifier unit (G) before pasting.
- Do not apply any glass cleaner after pasting the film antenna (F).

#### Part list for installation

(F) Film antenna (×1)

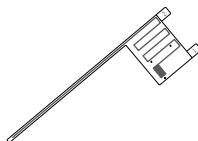

(G) Amplifier unit (cable with booster, 3.5 m) (×1)



(H) Cable clammer (×3)



(I) Cleaner (×1)



#### Determine the antenna installation position

- The direction of the film antenna (F) changes depending on whether the film antenna (F) is installed on the right side or left side.
- Be sure to check the installation location of film antenna (F) before installing. Film antenna cannot be re-pasted.
- Separate from other antennas by at least 100 mm.
- Do not paste the amplifier unit (G) on the ceramic line (black part) around the front glass. Because there is not enough adhesion.

■ Installing the antenna on the left side      ■ Installing the antenna on the right side

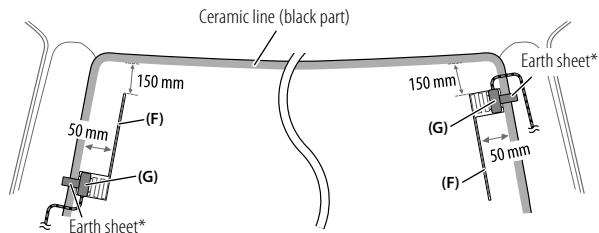

\* Paste the earth sheet of the amplifier unit (G) on the metal part of the front pillar.

## Installation/Connection

### ⚠ CAUTION

When installing the antenna cable inside the front pillar with the air bag installed

- The front pillar cover is secured with a special clip which may need to be replaced when it is removed. Contact your vehicle dealer for details on removing the front pillar cover and availability of replacement parts.

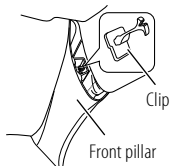

- Install the amplifier unit (G) above the air bag so that it does not obstruct the operation of the air bag.

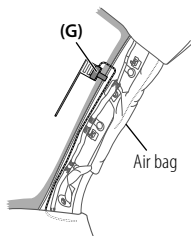

### Installation overview

The antenna should be installed on the passenger side for safety.

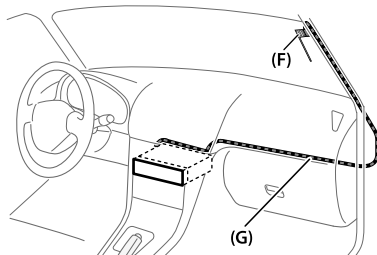

### Antenna installation

- 1 Remove the front pillar cover of your car.

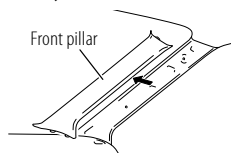

- 2 Clean the windscreen with the supplied cleaner (I).

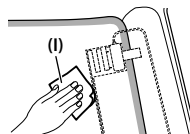

- Wait until the glass surface is completely dry before proceeding.
- Warm the surface of the windscreen with defroster if it is cold (during winter).

- 3 Remove the separator (tag 1) of film antenna (F) horizontally and paste the antenna on the windscreen.

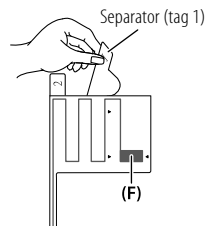

Do not touch the pasting surface (adhesive side) of the film antenna (F).

## Installation/Connection

- 4 Rub the film antenna gently onto the windscreen in the direction of the arrow shown to allow it to stick firmly.

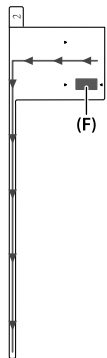

- 5 Remove the separator (tag 2) of film antenna (F) vertically.

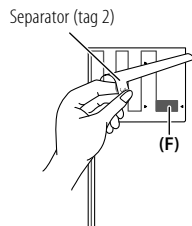

- 6 Set the position of the protrusion of the amplifier unit (G) with the ▼ mark on the film antenna (F) and paste.

Do not touch the lead terminal or the pasting surface (adhesive side) of the amplifier unit (G).

- When installing the antenna on the right side

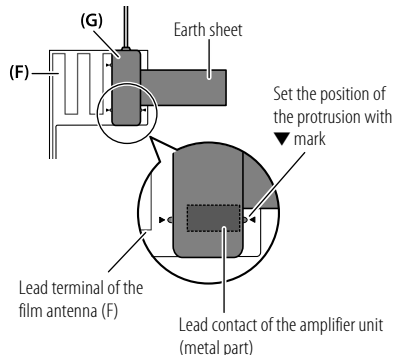

- When installing the antenna on the left side

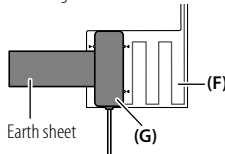

- 7 Remove the film covering the earth sheet and paste the earth sheet on the metal part of the vehicle.

Provide sufficient leeway for the earth sheet so that it does not interfere with the interior parts (front pillar cover). Also take care that the interior parts do not interfere with the amplifier unit (G).

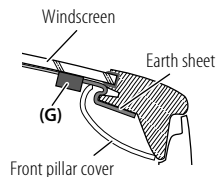

- 8 Wire the antenna cables.

Use cable clamber (H) to secure the antenna to the pillar at several positions.

- 9 Attach the front pillar cover back to its original position. Be sure not to damage the earth sheet and amplifier unit (G) when covering.

- 10 Connect the amplifier unit (G) to the DAB antenna jack on the rear of the unit.

Note:

Make sure [DAB ANT POWER] is set to [ON] on the [FUNCTION] menu in standby mode. (Page 6)  
[ON] is selected initially.



# References

## Maintenance

### Cleaning the unit

Wipe off dirt on the faceplate with a dry silicone or soft cloth.

### Cleaning the connector

Detach the faceplate and clean the connector gently with a cotton swab. Be careful not to damage the connector.



Connector (on the reverse side of the faceplate)

## More information

For: — Latest firmware updates and latest compatible item list  
— KENWOOD original application  
— Any other latest information

Visit <[www.kenwood.com/cs/ce/](http://www.kenwood.com/cs/ce/)>.

### Playable files

- Playable audio file for USB mass storage class device:  
MP3 (.mp3), WMA (.wma), AAC (.aac), AAC (.m4a), WAV (.wav), FLAC (.flac)
- Playable USB device file system: FAT12, FAT16, FAT32  
Even when audio files comply with the standards listed above, playback may be impossible depending on the types or conditions of media or devices.
- For detailed information and notes about the playable audio files, visit <[www.kenwood.com/cs/ce/audiofile/](http://www.kenwood.com/cs/ce/audiofile/)>.

### About USB devices

- You cannot connect a USB device via a USB hub.
- Connecting a cable whose total length is longer than 5 m may result in abnormal playback.
- This unit cannot recognize a USB device whose rating is other than 5 V and exceeds 1.5 A.

### About iPod/iPhone

- Made for
  - iPod touch (6th generation)
  - iPhone 5S, 6, 6 Plus, 6S, 6S Plus, SE, 7, 7 Plus, 8, 8 Plus, X, XS, XS MAX, XR (iOS 12.1 or later)
- It is not possible to browse video files on the “Videos” menu in **[MODE OFF]**.
- The song order displayed on the selection menu of this unit may differ from that of the iPod/iPhone.
- You cannot operate iPod if “KENWOOD” or “✓” is displayed on iPod.
- Depending on the version of the operating system of the iPod/iPhone, some functions may not operate on this unit.

### About Spotify

- Spotify application supports:
  - iPhone 5S, 6, 6 Plus, 6S, 6S Plus, SE, 7, 7 Plus, 8, 8 Plus, X, XS, XS MAX, XR (iOS 12.1 or later)
  - iPod touch (6th generation)
  - Android OS 4.0.3 or above
- Spotify is a third party service, therefore the specifications are subject to change without prior notice. Accordingly, compatibility may be impaired or some or all of the services may become unavailable.
- Some functions of Spotify cannot be operated from this unit.
- For issues using the application, please contact Spotify at <[www.spotify.com](http://www.spotify.com)>.

### About AMAZON ALEXA

- Alexa is a third party service, therefore the specifications are subject to change without prior notice. Accordingly, compatibility may be impaired or some or all of the services may become unavailable.

## References

### Change the display information

Each time you press DISP, the display information changes.

- If the information is unavailable or not recorded, "NO TEXT", "NO INFO", or other information (eg. station name) appears or display will be blank.

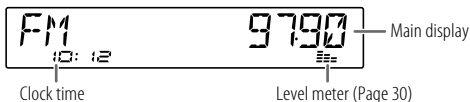

| Source name            | Display information: Main display  |
|------------------------|--|
| STANDBY                | Source name → Date → back to the beginning   |
| DIGITAL AUDIO          | Service label → Ensemble label → Dynamic label → Song title/Artist → Next program → Signal level → Date → back to the beginning  |
| RADIO                  | Frequency → Date → back to the beginning   |
|                        | For FM Radio Data System stations only:<br>Station name/Program type → Radio text → Radio text+ → Radio text+ song title/Radio text+ artist → Frequency → Date → back to the beginning |
| USB                    | For MP3/WMA/AAC/WAV/FLAC files:<br>Song title/Artist → Album title/Artist → Folder name → File name → Playing time → Date → back to the beginning                                      |
| iPod USB/<br>iPod BT   | When [MODE OFF] is selected (page 12):<br>Song title/Artist → Album title/Artist → Playing time → Date → back to the beginning   |
| SPOTIFY/<br>SPOTIFY BT | Context title → Song title → Artist → Album title → Playing time → Date → back to the beginning  |
| BT AUDIO/<br>ALEXA     | Song title/Artist → Album title/Artist → Playing time → Date → back to the beginning   |
| AUX                    | Source name → Date → back to the beginning   |

## Troubleshooting

|               | Symptom  | Remedy  |
|---------------|--|---|
| General       | Sound cannot be heard.   | <ul style="list-style-type: none"> <li>• Adjust the volume to the optimum level.</li> <li>• Check the cords and connections.</li> </ul>                 |
|               | "MISWIRING CHECK WIRING THEN PWR ON" appears.  | Turn the power off, then check to be sure the terminals of the speaker wires are insulated properly. Turn the power on again.                           |
|               | "PROTECTING SEND SERVICE" appears.   | Send the unit to the nearest service center.  |
|               | Source cannot be selected.   | Check the [SOURCE SELECT] setting. (Page 6)   |
|               | <ul style="list-style-type: none"> <li>• Sound cannot be heard.</li> <li>• The unit does not turn on.</li> <li>• Information shown on the display is incorrect.</li> </ul> | Clean the connectors. (Page 37)   |
| Digital Radio | The unit does not work at all.   | Reset the unit. (Page 4)  |
|               | Correct characters are not displayed.  | <ul style="list-style-type: none"> <li>• This unit can only display uppercase letters, numbers, and a limited number of symbols.</li> </ul>             |
|               | DAB reception is poor.   | Make sure [ON] is selected for [DAB ANT POWER]. (Page 6)  |
|               | "DAB ANT ERR"  | Check the DAB antenna. If a passive antenna (without a booster) is used, set [DAB ANT POWER] to [OFF]. (Page 6)   |
|               | "RELATED SERV FOUND"   | <ul style="list-style-type: none"> <li>• Press the volume knob to activate Soft-Link. (Page 8)</li> <li>• Press <b>Q</b>/<b>S</b> to cancel.</li> </ul> |

## Troubleshooting

|  | Symptom  | Remedy  |
|--|--|---|
| Analog<br>Radio                                    | <ul style="list-style-type: none"> <li>Radio reception is poor.</li> <li>Static noise while listening to the radio.</li> </ul>   | Connect the antenna firmly.   |
|  | Playback order is not as intended.   | The playback order is determined by the order in which file name were recorded (USB).   |
| USB/iPod   | Elapsed playing time is not correct.   | This depends on the recording process earlier (USB).  |
|  | "READING" keeps flashing.  | <ul style="list-style-type: none"> <li>Do not use too many hierarchical levels and folders.</li> <li>Reattach the device (USB/iPod/iPhone).</li> </ul>  |
|  | "UNSUPPORTED DEVICE" appears.  | <ul style="list-style-type: none"> <li>Check whether the connected USB device is compatible with this unit and ensure the file systems are in supported formats. (Page 37)</li> <li>Reattach the USB device.</li> </ul>   |
|  | "UNRESPONSIVE DEVICE" appears.   | Make sure the USB device is not malfunction and reattach the USB device.  |
|  | "USB HUB IS NOT SUPPORTED" appears.  | This unit cannot support a USB device connected via a USB hub.  |
|  | <ul style="list-style-type: none"> <li>The source does not change to "USB" when you connect a USB device while listening to another source.</li> <li>"USB ERROR" appears.</li> </ul> | <p>The USB port is drawing more power than the design limit. Turn the power off and unplug the USB device. Then, turn on the power and reattach the USB device. If this does not solve the problem, turn the power off and on (or reset the unit) before replacing with another USB device.</p> |
| The iPod/iPhone does not turn on or does not work. | <ul style="list-style-type: none"> <li>Check the connection between this unit and iPod/iPhone.</li> <li>Disconnect and reset the iPod/iPhone using hard reset.</li> </ul>            |   |

|          | Symptom  | Remedy  |
|----------|--|---|
| USB/iPod | "LOADING" appears when you enter search mode by pressing <b>Q/</b> | This unit is still preparing the iPod/iPhone music list. It may take some time to load, try again later.  |
|          | "NA FILE"  | Make sure the media (USB) contain supported audio files. (Page 37)  |
|          | "COPY PRO"   | A copy-protected file is played (USB).  |
|          | "NO DEVICE"  | Connect a device (USB/iPod/iPhone), and change the source to USB or iPod USB again.   |
|          | "NO MUSIC"   | Connect a device (USB/iPod/iPhone) that contains playable audio files.  |
|          | "iPod ERROR"   | <ul style="list-style-type: none"> <li>Reconnect the iPod.</li> <li>Reset the iPod.</li> </ul>  |
| Spotify  | "MEMORY FULL"  | You have reached the maximum storage limit of your iPod/iPhone.   |
|          | "DISCONNECTED"   | USB is disconnected from the head unit. Please make sure the device is connected properly through USB.  |
|          | "CONNECTING"   | <ul style="list-style-type: none"> <li>Connected via USB input terminal: The device is connecting to the head unit. Please wait.</li> <li>Connected via Bluetooth: The Bluetooth is disconnected. Please check Bluetooth connection and make sure both the device and unit are paired and connected.</li> </ul> |
|          | "CHECK APP"  | The Spotify application is not connected properly or user is not login. End the Spotify application and restart. Then, log in to your Spotify account.  |

## Troubleshooting

| Symptom  | Remedy  |
|--|---|
| No Bluetooth device is detected.   | <ul style="list-style-type: none"> <li>Search from the Bluetooth device again.</li> <li>Reset the unit. (Page 4)</li> </ul>   |
| Bluetooth pairing cannot be made.  | <ul style="list-style-type: none"> <li>Make sure you have entered the same PIN code to both the unit and Bluetooth device.</li> <li>Delete pairing information from both the unit and the Bluetooth device, then perform pairing again. (Page 17)</li> </ul>            |
| Echo or noise is heard during a phone conversation.                                | <ul style="list-style-type: none"> <li>Adjust the microphone unit's position. (Page 17)</li> <li>Check the <b>[ECHO CANCEL]</b> setting. (Page 19)</li> </ul>   |
| Phone sound quality is poor.   | <ul style="list-style-type: none"> <li>Reduce the distance between the unit and the Bluetooth device.</li> <li>Move the car to a place where you can get a better signal reception.</li> </ul>  |
| Voice calling method is not successful.  | <ul style="list-style-type: none"> <li>Use voice calling method in a more quiet environment.</li> <li>Reduce the distance from the microphone when you speak the name.</li> <li>Make sure the same voice as the registered voice tag is used.</li> </ul>                |
| Sound is being interrupted or skipped during playback of a Bluetooth audio player. | <ul style="list-style-type: none"> <li>Reduce the distance between the unit and the Bluetooth audio player.</li> <li>Turn off, then turn on the unit and try to connect again.</li> <li>Other Bluetooth devices might be trying to connect to the unit.</li> </ul>      |
| The connected Bluetooth audio player cannot be controlled.                         | <ul style="list-style-type: none"> <li>Check whether the connected Bluetooth audio player supports Audio/Video Remote Control Profile (AVRCP). (Refer to the instructions of your audio player.)</li> <li>Disconnect and connect the Bluetooth player again.</li> </ul> |
| "NOT SUPPORT"  | The connected phone does not support Voice Recognition feature or phonebook transfer.   |

Bluetooth®

| Symptom   | Remedy   |
|---|--|
| "NO ENTRY"/"NO PAIR"  | There is no registered device connected/found via Bluetooth.   |
| "ERROR"   | Try the operation again. If "ERROR" appears again, check if the device supports the function you have tried.   |
| "NO INFO"/"NO DATA"   | Bluetooth device cannot get the contact information.   |
| "HF ERROR XX"/<br>"BT ERROR"  | Reset the unit and try the operation again. If this does not solve the problem, consult your nearest service center.   |
| "SWITCHING NG"  | The connected phones might not support phone switching feature.  |
| The Bluetooth connection between the Bluetooth device and the unit is unstable. | Delete the unused registered Bluetooth device from the unit. (Page 21)   |
| No response from Alexa after the voice input.                                   | Amazon cloud was unable to analyze the voice input.  |
| Wrong response from Alexa.  | Alexa misunderstood what was said or did not catch the entire request or sentence spoken. Please try again. (Page 23)  |
| "DISCONNECTED"  | Be sure to connect your smartphone to the unit via Bluetooth. (Page 17)  |
| Not able to connect or reconnect to Alexa mobile application.                   | <ul style="list-style-type: none"> <li>Be sure the audio device is connected via Bluetooth. Select the audio device from <b>[AUDIO SELECT]</b> in <b>[BT MODE]</b>. (Page 21)</li> <li>Perform the one-time setup process again. See "Setup for the first time" on page 23.</li> <li>Turn off, then turn on the unit and try to connect again.</li> <li>For iOS device, make sure ALEXA source or iPod BT source is selected.</li> </ul> |

Bluetooth®

AMAZON ALEXA

# Specifications

|               |     |                         |  |
|---------------|-----|-------------------------|--|
| Digital radio | DAB | Frequency Range         | Band III:<br>174.928 MHz — 239.200 MHz |
|               |     | Sensitivity             | -100 dBm                               |
|               |     | Signal-to-Noise Ratio   | 90 dB                                  |
|               |     | Antenna Connector Type  | SMB                                    |
|               |     | Antenna Output Voltage  | 12 V DC                                |
|               |     | Antenna Maximum Current | < 100 mA                               |

|              |    |  |                                      |
|--------------|----|--|--------------------------------------|
| Analog radio | FM | Frequency Range                        | 87.5 MHz — 108.0 MHz (50 kHz step)   |
|              |    | Usable Sensitivity (S/N = 30 dB)       | 6.2 dBf (0.56 $\mu$ V/75 $\Omega$ )  |
|              |    | Quieting Sensitivity (DIN S/N = 46 dB) | 15.2 dBf (1.58 $\mu$ V/75 $\Omega$ ) |
|              |    | Frequency Response ( $\pm 3$ dB)       | 30 Hz — 15 kHz                       |
|              |    | Signal-to-Noise Ratio (MONO)           | 68 dB                                |
|              |    | Stereo Separation (1 kHz)              | 40 dB                                |
|              | AM | Frequency Range                        | 531 kHz — 1 701 kHz (9 kHz step)     |
|              |    | Usable Sensitivity (S/N = 20 dB)       | 29.1 dB $\mu$ (28.5 $\mu$ V)         |

|             |                                  |                                       |
|-------------|----------------------------------|---------------------------------------|
| USB         | USB Standard                     | USB 1.1, USB 2.0 (High speed)         |
|             | File System                      | FAT12/16/32                           |
|             | Maximum Supply Current           | DC 5 V $\leq$ 1.5 A                   |
|             | Frequency Response ( $\pm 1$ dB) | 20 Hz — 20 kHz                        |
|             | Signal-to-Noise Ratio (1 kHz)    | 98 dB                                 |
|             | Dynamic Range                    | 93 dB                                 |
|             | Channel Separation               | 90 dB                                 |
|             | MP3 Decode                       | Compliant with MPEG-1/2 Audio Layer-3 |
|             | WMA Decode                       | Compliant with Windows Media Audio    |
|             | AAC Decode                       | AAC-LC ".aac", ".m4a" files           |
| WAV Decode  | Linear-PCM                       |                                       |
| FLAC Decode | FLAC file (Up to 96 kHz/24 bit)  |                                       |

|           |                                  |                |
|-----------|----------------------------------|----------------|
| Auxiliary | Frequency Response ( $\pm 3$ dB) | 20 Hz — 20 kHz |
|           | Input Maximum Voltage            | 1 000 mV       |
|           | Input Impedance                  | 30 k $\Omega$  |

|           |                             |  |
|-----------|-----------------------------|--|
| Bluetooth | Version                     | Bluetooth 4.2  |
|           | Frequency Range             | 2.402 GHz — 2.480 GHz  |
|           | RF Output Power (E.I.R.P.)  | +4 dBm (MAX), Power Class 2  |
|           | Maximum Communication Range | Line of sight approx. 10 m (32.8 ft)   |
|           | Profile                     | HFP 1.7.1 (Hands-Free Profile)<br>A2DP (Advanced Audio Distribution Profile)<br>AVRCP 1.6.1 (Audio/Video Remote Control Profile)<br>PBAP (Phonebook Access Profile)<br>SPP (Serial Port Profile) |

## Specifications

|                   |   |                         |               |
|-------------------|---|-------------------------|---------------|
| Audio             | Maximum Output Power                                | 50 W × 4                |               |
|                   | Full Bandwidth Power<br>(at less than 1 % THD)      | 22 W × 4                |               |
|                   | Speaker Impedance                                   | 4 Ω — 8 Ω               |               |
|                   | Tone Action   | Band 1:                 | 62.5 Hz ±9 dB |
|                   |   | Band 2:                 | 100 Hz ±9 dB  |
|                   |   | Band 3:                 | 160 Hz ±9 dB  |
|                   |   | Band 4:                 | 250 Hz ±9 dB  |
|                   |   | Band 5:                 | 400 Hz ±9 dB  |
|                   |   | Band 6:                 | 630 Hz ±9 dB  |
|                   |   | Band 7:                 | 1 kHz ±9 dB   |
| Band 8:           |   | 1.6 kHz ±9 dB           |               |
| Band 9:           |   | 2.5 kHz ±9 dB           |               |
| Band 10:          |   | 4 kHz ±9 dB             |               |
| Band 11:          |   | 6.3 kHz ±9 dB           |               |
| Band 12:          |   | 10 kHz ±9 dB            |               |
| Band 13:          |   | 16 kHz ±9 dB            |               |
| Preout Level/Load | 2 500 mV/10 kΩ                                      |                         |               |
| Preout Impedance  | ≤ 600 Ω   |                         |               |
| General           | Operating Voltage                                   | 12 V DC car battery     |               |
|                   | Installation Size (W × H × D)                       | 182 mm × 53 mm × 100 mm |               |
|                   | Net Weight (includes Trimplate,<br>Mounting Sleeve) | 0.7 kg                  |               |

Subject to change without notice.



- Microsoft and Windows Media are either registered trademarks or trademarks of Microsoft Corporation in the United States and/or other countries.
- Use of the Made for Apple badge means that an accessory has been designed to connect specifically to the Apple product(s) identified in the badge and has been certified by the developer to meet Apple performance standards. Apple is not responsible for the operation of this device or its compliance with safety and regulatory standards. Please note that the use of this accessory with an Apple product may affect wireless performance.
- Apple, iPhone, iPod, iPod touch, and Lightning are trademarks of Apple Inc., registered in the U.S. and other countries.
- Android is a trademark of Google LLC.
- SPOTIFY and the Spotify logo are among the registered trademarks of Spotify AB.
- The Bluetooth® word mark and logos are registered trademarks owned by Bluetooth SIG, Inc. and any use of such marks by JVCKENWOOD Corporation is under license. Other trademarks and trade names are those of their respective owners.
- Amazon Alexa is not available in all languages and countries.
- Amazon, Alexa and all related logos are trademarks of Amazon.com, Inc. or its affiliates.