

DMX120BT

MONITOR WITH RECEIVER

INSTRUCTION MANUAL

JVCKENWOOD Corporation

- Updated information (the latest Instruction Manual, etc.) is available from <http://www.kenwood.com/cs/ce/>..

Model name indication position

See "Removing the trim plate" (P.22)

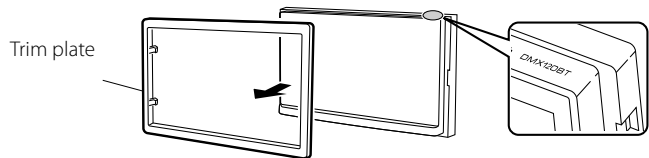

Contents

Before use	2
How to read this manual.....	2
Precautions	2
Getting Started	3
Clock settings.....	4
Touch panel adjustment.....	4
Basics	5
Functions of the Buttons on the Front Panel.....	5
Common operations	5
HOME screen descriptions	6
Source control screen descriptions	6
List screen	6
USB	7
Preparation.....	7
Playback operations.....	7
iPod/iPhone	9
Preparation.....	9
Playback operations.....	9
Mirroring	11
Preparation.....	11
Mirroring operations.....	11
Radio	12
Radio Basic Operation.....	12
Presetting stations	12
FM RDS features.....	12
Radio Setup.....	13
External Components	14
Using external audio/video players.....	14
Rear view camera.....	14
Bluetooth smartphone	15
Register your smartphone to the unit	15
Receive a phone call.....	15
Make a phone call.....	16
Playing Bluetooth Audio Device.....	17
Delete the registered Bluetooth device	17
Controlling Audio	18
Controlling General Audio.....	18
Equalizer Control	18
Subwoofer settings	18
Remote control	19
Functions of the Remote control Buttons.....	19
Installation.....	20
Before Installation.....	20
Installing the unit.....	21
About this Unit.....	25
More information.....	25
Troubleshooting.....	25
Copyrights	26
Specifications	28

How to read this manual

- The panels shown in this guide are examples used to provide clear explanations of the operations. For this reason, they may be different from the actual panels.
- In operation procedures, bracket shape indicates the key or button you should control.
 - < >: indicates the name of panel buttons.
 - []: indicates the name of touch keys.

Before use

Precautions

▲WARNING

■ To prevent injury or fire, take the following precautions

- To prevent a short circuit, never put or leave any metallic objects (such as coins or metal tools) inside the unit.
- Do not watch or fix your eyes on the unit's display when you are driving for any extended period.
- If you experience problems during installation, consult your KENWOOD dealer.

■ Precautions on using this unit

- When you purchase optional accessories, check with your KENWOOD dealer to make sure that they work with your model and in your area.
- The Radio Data System or Radio Broadcast Data System feature won't work where the service is not supported by any broadcasting station.

■ Protecting the monitor

- To protect the monitor from damage, do not operate the monitor using a ballpoint pen or similar tool with the sharp tip.

■ Cleaning the Unit

If the front panel of this unit is stained, wipe it with a dry soft cloth such as a silicon cloth. If the front panel is stained badly, wipe the stain off with a cloth moistened with neutral cleaner, then wipe it again with a clean soft dry cloth.

▲ CAUTION

- Applying spray cleaner directly to the unit may affect its mechanical parts. Wiping the front panel with a hard cloth or using a volatile liquid such as thinner or alcohol may scratch the surface or erase screened print.

■ How to reset your unit

If the unit or the connected unit fails to operate properly, reset the unit.

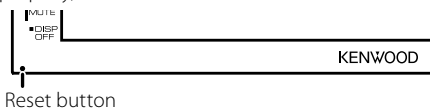

Reset button

Getting Started

1 Turn the ignition key of your car to ACC.

The unit is turned on.

2 Press the <MENU> button.

3 Touch [Setup].



4 Touch the corresponding key and set the value.

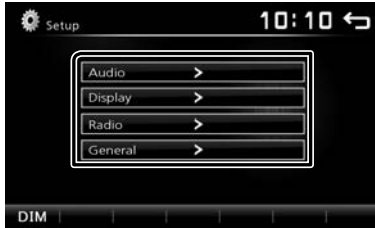

Audio

Sound Effect

Displays the Equalizer screen. **(P.18)**

Beep

Activates or deactivates the key-touch tone.

“ON” (Default), “OFF”

Loudness

Sets the amounts of boost of low and high tones.

“ON”, “OFF” (Default)

Subwoofer

Displays the Subwoofer screen. **(P.18)**

Display

Touch

Adjust the sensing position of touch panel. See

“Touch panel adjustment” **(P.4)**.

Display Mode

Select the screen mode.

“16:9” (Default), “4:3 Pan Scan”

Radio

Displays the Radio Settings screen. **(P.13)**

General

Language

Select the language used for the control screen and setting items. Default is “English”.

1) Touch [Language].

2) Select the desired language.

* You can change the page to display more items by pressing [**↑**] / [**↓**].

BT Auto Connection

The unit automatically reconnect when the last connected Bluetooth device is within range.

“ON” (Default), “OFF”

Clock Setting

Adjust the clock time. **(P.4)**.

Default

Touch [Default] to set all the settings to the initial default settings.

5 Touch [**↩**].

Getting Started

Clock settings

☑ Synchronizing the clock time with FM RDS

Activate [RDS Clock Sync]. See "Radio Setup" (P.13).

☑ Adjusting the clock manually

📎 NOTE

• Deactivate [RDS Clock Sync] before adjusting the clock. See "Radio Setup" (P.13).

1 Press the <⏻MENU> button.

2 Touch [Setup].

3 Touch [General].

4 Touch [Clock Setting].

Clock screen appears.

5 Selects time format.

[12] / [24] (Default)



6 Touch [▲] or [▼] to set the clock time.

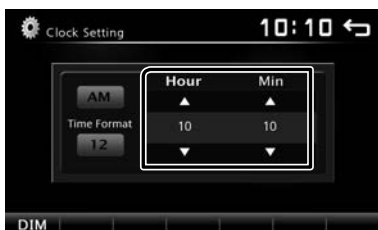

• If you have selected [12] as the time format, touch [AM] or [PM] before setting the clock time.

7 Touch [↵].

Touch panel adjustment

1 Press the <⏻MENU> button.

2 Touch [Setup].

3 Touch [Display].

4 Touch [Touch].

5 Follow the instruction on the screen and touch the center of each +.



• To cancel the touch panel adjustment, touch [Cancel].

• If the touch position is deviated, [OK] is not displayed. Retry from the beginning.

6 Touch [OK].

Basics

Functions of the Buttons on the Front Panel

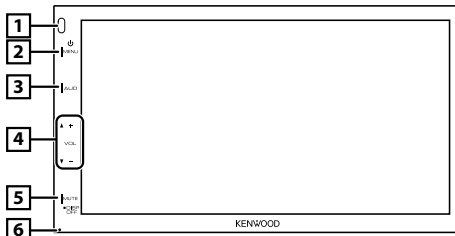

1 Remote Sensor

- Receives the remote control signal.

2 MENU

- Displays the HOME screen. **(P.6)**
- Pressing for 1 second turns the power off.
- When the power off, turns the power on.

3 AUD

- Displays the Equalizer screen.* **(P.18)**
- * During video file playback, you can set only the preset equalizer curve.
- * The Equalizer screen is not displayed during picture file playback or on the list screen or SETUP screen etc,

4 +, - (Volume)

- Adjusts volume. The volume will go up until 20 when you keep pressing [+].

5 MUTE/ DISP OFF (Display off)

- Mutes/restores the sound.
- Pressing for 1 second turns the screen off. When the screen is off, touch the display to turn on the screen.

6 Reset

- If the unit or the connected unit fails to operate properly, the unit returns to factory settings when this button is pressed.

Common operations

Turning on the power

- 1 Press the <MENU> button.



NOTE

- If the gear is in the reverse (R) position, the power cannot be turned on or off.

Turning off the power

- 1 Press and hold the <MENU> button.



Adjusting the volume

- 1 Press the <+> or <-> button.

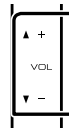

NOTE

- The volume will go up until 20 when you keep pressing [+].

Mutes the sound

- 1 Press the <MUTE> button.



KENWOOD

- To restore the sound, touch the button again, or adjust the volume.

Turn off the screen

- 1 Press and hold the <MUTE> button.



KENWOOD

- To turn on the screen, touch the display.

Basics

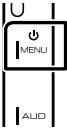

HOME screen descriptions

1 Press the <MENU> button.



HOME screen appears.





- 1 Clock display
Touch to displays the Clock screen.
- 2 Switches to the radio broadcast. **(P.12)**
- 3 **[USB]** 
Plays files on a USB device. **(P.7)**
- [iPod]** 
Plays an iPod/iPhone. **(P.9)**
 - When iPod/iPhone is connected.
- [Mirroring]** 
Displays the Mirroring screen.**(P.11)**
 - When android device with "Mirroring OA for KENWOOD" application installed is connected.
- 4 Switches to an external component connected to the AV-IN input terminal. **(P.14)**
- 5 Displays the Hands Free screen. **(P.16)**
- 6 Plays a Bluetooth audio player. **(P.17)**
- 7 Displays the SETUP screen. **(P.3)**

Source control screen descriptions

You can perform source playback operations on the source control screen.





- 1 Clock display
Touch to displays the Clock screen.
- 2 Source name
- 3  appears when the Bluetooth smartphone is connected.
 -  appears when the Bluetooth audio player is connected.
 -  appears when the mute function is active. **(P.5)**
- 4 **[DIM]**
Select dimmer mode. Dim 1, Dim 2, Not dim
- 5 Returns to previous screen.

List screen

There are some common function keys in the list screens of most sources.



1 You can change the page to display more items by pressing []/ [].

USB

Preparation

Connecting a USB device

- 1 Remove the cap of the USB terminal.
- 2 Connect the USB device with the USB cable.

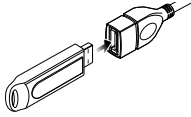

The unit reads the device and playback starts.

To disconnect the USB device

- 1 Press the <MENU> button.
- 2 Touch a source other than [USB].
- 3 Detach the USB device.

Usable USB device

This unit can play MPEG1/ MPEG2/ MPEG4/ H.264/ MKV/ WMV/ MP3/WMA/ AAC/ WAV/ FLAC/ JPEG/ BMP/ PNG files stored in a USB mass storage class device. (P.25)

- File system: FAT16/ FAT32
- This unit can recognize a total of 9 999 files and 320 folders (a maximum of 9 999 files per folder).
- The maximum number of characters:
 - Folder names : 24 characters
 - File names : 24 characters
 - Tag : 30 characters

NOTE

- When the USB device is connected to this unit, it can be charged through the USB cable.
- Install the USB device in the place where it will not affect safe driving.
- You cannot connect a USB device via a USB hub and Multi Card Reader.
- Take backups of the audio files used with this unit. The files may be erased depending on the operating conditions of the USB device. We shall have no compensation for any damage arising from any erased data.
- No USB device comes with this unit. You need to purchase a commercially available USB device.
- Cap the USB terminal whenever not using.

Playback operations

Control the music you are listening to on the source control screen



1 The jacket of the currently playing file is displayed.

2 ###:###:### : Song time
Play time bar : For confirmation of current playing position

3 [▶||] : Plays or pauses.
[◀◀] [▶▶] : Searches the previous/next content. Touch and hold to fast forward or fast backward. Touch [▶||] to resumes normal play.
[↺] : Selects Repeat playback mode.

Lights off (Default): Repeats all files in the USB device.

↺ : Repeats the current file.

FO ↺ : Repeats all files in the current folder.

[◻] : Selects Random playback mode.

✂ : Randomly plays all files.

Lights off (Default): Normal playback.

4 Displays the information of the current file. Only a file name is displayed if there is no tag information.

5 Searches file. (P.8)

6 ▶, etc. : Playback status

↺ : Repeat playback mode indicator

✂ : Random playback mode indicator

■ Playing videos and pictures

1 When the operation buttons are not displayed on the screen, touch the display.



- 1 ▶, etc. : Playback status
- ↺ : Repeat playback mode indicator
- ⊗ : Random playback mode indicator
- ##:##:## : Song time (Video file only)
- Play time bar** : For confirmation of current playing position (Video file only)

- 2 To switch the operation buttons.

- 3 [🔍] : You can adjust image quality in video screen.
 - [Brightness]**: Adjusts the brightness. (00 to 12)
 - [Contrast]**: Adjusts the contrast. (00 to 12)
 - [Tint]**: Adjusts the tint. (00 to 12)
 - [Color]**: Adjusts the color. (00 to 12)
 - [Reset]**: To clear the adjustment.
- [🔍] : Select the zoom ratio.
 "Off", "x2", "x3", "x4", "x5", "1/2", "1/3", "1/4"
- [↶][↷][<][>] : Scrolls the screen.

4 The operation buttons disappear when 4 is touched or when no operation is done for about 10 seconds.

5 Displays the File List screen.* (**P.8**)
 * Stops the currently playing file.

■ Selecting a track in a list (Searches file)

- 1 Touch [☰].
- 2 Select whether you search by audio files [🎵], video files [📺] or picture files [🖼️].

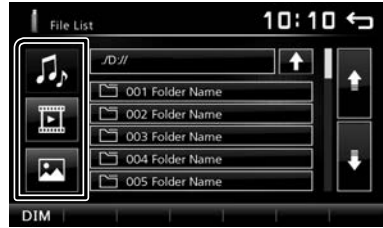

- 3 Touch [↑] to moves to the upper hierarchy.
- 4 Touch the desired folder.

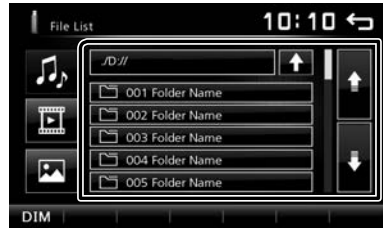

When you touch a folder its contents are displayed.

5 Touch desired item from the content list.

Playback starts.

NOTE

- When file types are switched, the Random/Repeat playback setting is cancelled.

iPod/iPhone

Preparation

Connecting iPod/iPhone

- For Lightning connector models: Use USB Audio cable for iPod/iPhone—KCA-iP103 (optional accessory).
- For details about connecting iPod/iPhone, see page 24.

1 Remove the cap of the USB terminal.

2 Connect the iPod/iPhone.

The unit reads the device and playback starts.

To disconnect the iPod/iPhone

1 Press the <MENU> button.

2 Touch a source other than [iPod].

3 Detach the iPod/iPhone.

Connectable iPod/iPhone

The following models can be connected to this unit.

Made for

iPhone XS Max	iPhone SE
iPhone XS	iPhone 6s Plus
iPhone XR	iPhone 6s
iPhone X	iPhone 6 Plus
iPhone 8 Plus	iPhone 6
iPhone 8	iPhone 5s
iPhone 7 Plus	
iPhone 7	

NOTE

- If you start playback after connecting the iPod, the music that has been played by the iPod is played first.
- Cap the USB terminal whenever not using.

Playback operations

Control the music you are listening to on the source control screen



1 Artwork (Shown if the track contains artwork)

2 ##:##:## : Song time

Play time bar : For confirmation of current playing position

3 **[▶||]** : Plays or pauses.

[◀◀] [▶▶] : Searches the previous/next content.
Touch and hold to fast forward or fast backward.

[↺] : Selects Repeat playback mode.

Lights off: Repeat off

↺ : Functions the same as Repeat All.

↺1 : Functions the same as Repeat One.

[◀▶] : Selects Random playback mode.

◀▶ : Functions the same as Shuffle Songs.

Lights off: Random off

4 Displays the information of the current file.

5 Searches content. **(P.10)**

6 **▶, etc.** : Playback status

↺ : Repeat playback mode indicator

◀▶ : Random playback mode indicator

iPod/iPhone

■ Selecting a content in a list

1 Touch [☰].

2 Touch desired item.



When you touch a category its contents are displayed.

3 Touch desired item from the content list.

Playback starts.

- Touch [↶] to moves to the upper hierarchy.

📌 NOTE

- The source control screen appears when you touch [↶] at the top hierarchy.

Mirroring

Preparation

Pair your smartphone with the unit via Bluetooth.
See **Register your smartphone to the unit (P.15)**
and Connect the Bluetooth device.

Compatible Android smartphone

- Android version 7.0 or later
- Bluetooth support

NOTE

- This unit may not work for some Android smartphone's.

Connecting Android smartphone

- For details about connecting Android smartphone, see page 24 .

1 Download Mirroring App from Google Play.

Install the latest version of the Mirroring application "Mirroring OA for KENWOOD" on your Android.

2 Remove the cap of the USB terminal.

3 Connect the Android smartphone.

4 Launch Mirroring App on your Android Smartphone.

Touch "OK" to start Mirroring App.

Touch "Start now" to start capturing your Android screen.

5 Start to enjoy Mirroring.

To disconnect the Android smartphone

1 Press the <MENU> button.

2 Touch a source other than [Mirroring].

3 Detach the Android smartphone.

Mirroring operations

Mirroring Operation

1 Touch [Mirroring].



- You can display the same screen of the Android device on the monitor of the unit.

To turn off the Mirroring

1 Press the <MENU> button.



- HOME screen appears.

Radio

Radio Basic Operation

- 1 Press the $\langle \text{MENU} \rangle$ button.
- 2 Touch [Radio].

Source control screen



1 Displays the information of the current station: PS name, Frequency, PTY Genre, Indicator Items
[<<] [>>]: Touch to the next frequency manually.

2 Recalls the memorized station.
When touched for 2 seconds, stores the current receiving station in memory.

3 [◀▶] [▶▶]: Tunes in a station with good reception automatically. *1

[TA]: Sets the traffic information mode.

"ON", "OFF" (Default) *2 (P.12)

[PTY]: Select the available Program Type. *2 (P.12)

*1 If "AF" is set to ON on the Tuner screen, only RDS stations are received. (P.13)

*2 FM only

4 [Q]: Presets stations automatically. (P.12)

5 [FM]: Switches the FM band.
"FM1", "FM2", "FM3"

[AM]: Switches the AM band.
"AM1", "AM2"

Presetting stations

Auto memory

You can preset 18 stations for FM and 12 stations for AM.

1 Touch [FM] or [AM] to select the band.

2 Touch [Q].

The local stations with the strongest signals are found and stored automatically.

• If "AF" is set to "ON" on the Tuner screen, only RDS stations are stored in the memory. (P.13)

Manual memory

You can store the current receiving station in memory.

1 Tune in to a station you want to preset.

2 Touch and hold [#] (#:1-6) in which you want to store the station.

Recalling the preset station

1 Touch [#] (#:1-6).

NOTE

• Only frequencies are registered as preset stations. Information about RDS stations is not registered.

FM RDS features

Search by program type

1 Touch [PTY].

2 Select a program type from the list.



PTY Search starts.

Traffic Information

1 Touch [TA].

Switches to the traffic information automatically when the traffic bulletin starts. (TA indicator lights up.)
"ON", "OFF" (Default)

• If "AF" is set to "ON" on the Tuner screen, the station is switched to the RDS station. (P.13)

When the traffic bulletin starts

The Traffic Information screen appears automatically.

Radio

Radio Setup

Function menu

1 Press the <MENU> button.

2 Touch [Setup].



3 Touch [Radio].

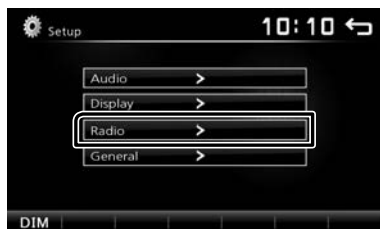

4 Set each item as follows.

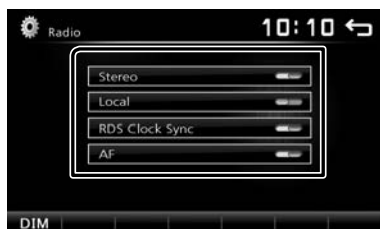

Stereo

Determines whether to receive stereo broadcasts in the stereo mode or monaural mode (the **MONO** indicator lights up).

"ON" (Default), "OFF"

Local

Tunes in only to the stations with sufficient signal strength. (**LOC** indicator lights up.)

"ON", "OFF" (Default)

RDS Clock Sync

Synchronizing the Radio Data System station time data and this unit's clock.

"ON" (Default), "OFF"

AF

When station reception is poor, automatically switches to the station that is broadcasting the same program over the same Radio Data System network.

"ON" (Default), "OFF"

5 Touch [↵].

External Components

Using external audio/video players

Starting playback

- 1 Connect an external component to the AV-IN input terminal. (P.23)
- 2 Press the <MENU> button.
- 3 Touch [AV-IN].
- 4 Turn on the connected component and start playing the source.

For Video playback

- 1 When the operation buttons are not displayed on the screen, touch the display.



The operation buttons disappear when 1 is touched or when no operation is done for about 5 seconds.

NOTE

- When the picture from the rear view camera is displayed on the AV-IN screen, the picture output from the Visual Output terminal disappears.

Rear view camera

To use a rear view camera, the REVERSE lead connection is required. For connecting a rear view camera. (P.23)

Displaying the picture from the rear view camera

The rear view screen is displayed when you shift the gear to the reverse (R) position.



- To erase the caution message, touch the screen.

Bluetooth smartphone

About the Bluetooth smartphone and Bluetooth audio player

This unit conforms to the following Bluetooth specifications:

Version

Bluetooth Ver.2.1 + EDR

Profile

Smartphone/ Cell-phone:

HFP (V1.6) (Hands Free Profile)

PBAP (V1.1.1) (Phonebook Access Profile)

Audio player:

A2DP (V1.2) (Advanced Audio Distribution Profile)

AVRCP (V1.3) (Audio/Video Remote Control Profile)

Sound codec

SBC

About mobile phones compatible with Phone book Access Profile (PBAP)

If your mobile phone supports PBAP, you can display the following items on the touch panel screen when the mobile phone is connected.

- Phone book (up to 1000 entries)
- Dialed calls, received calls, and missed calls (up to 20 entries in total)

Register your smartphone to the unit



You can use your Bluetooth smartphone when paired to this unit.

You can register up to 5 Bluetooth devices.

- You can pair the device and the unit using SSP (Secure Simple Pairing) which only requires confirmation.
- One device can be connected at a time.
- When you register a new Bluetooth device, disconnect the Bluetooth device currently connected and then register the new device.
- A new device cannot be registered if there are 5 registered Bluetooth units. Delete unnecessary registration. (P.17)

1 Turn on the Bluetooth function on your smartphone/cell-phone.

2 Search the unit from your smartphone/cell-phone.

- If a PIN code is required, enter the PIN code ("0000").
-  appears when the Bluetooth smartphone is connected.
 -  appears when the Bluetooth audio player is connected.

Disconnecting the device

- Turn off the Bluetooth function from your smartphone/cell-phone.
- Turn off the ignition switch.

Receive a phone call

1 Touch .

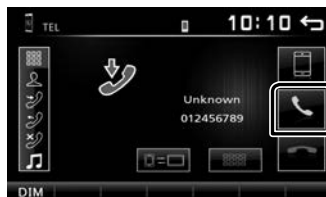

-  : Reject an incoming call.

Operations during a call

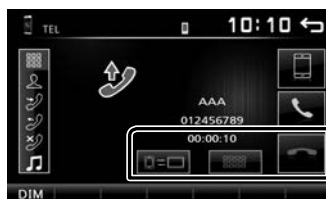

 Ending a call

 You can send tones by touching desired keys on the screen.

- Touch  to close the window.

 Switches the speaking voice output between cell-phone and speaker.

• Adjust the receiver volume

Press the <+> or <-> button.

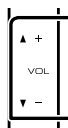

Bluetooth smartphone

Make a phone call

- 1 Press the <MENU> button.
- 2 Touch [TEL].
- 3 See the table below for each operation method.



- [] : Disconnects the Bluetooth smartphone.
 - [] : Closes the screen for sending tones while talking.
 - [] : Displays the screen for deleting the previously registered Bluetooth devices.
- (P.17)**

Call by entering a phone number

- 1) Touch [].
 - 2) Enter a phone number with number keys.
 - 3) Touch [].
- Make a call
- Touch [] to delete the last entry.

Call using call records

- 1) Touch [] (Incoming Calls), [] (Outgoing Calls), [] (Missed Calls).
- 2) Select the phone number from the list.



Make a call

Call using the phonebook

- 1) Touch [].
- 2) Select the name from the list.



Make a call

- [] : Updates the phonebook. Touch this button after you have made a change to the phonebook of your cell-phone.

Call by voice

You can make a voice call using the voice recognition function of the Bluetooth smartphone.

- 1) Touch [].
- 2) Touch [].
- 3) Say the name registered in the Bluetooth smartphone.

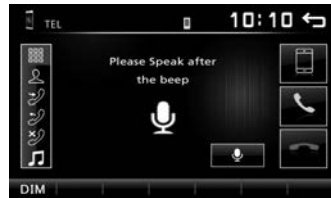

- Touch [] to cancel voice dialing.

Bluetooth smartphone

Playing Bluetooth Audio Device

- 1 Press the <MENU> button.
- 2 Touch [BT Audio].

Source control screen



- 1 [▶||] : Plays or pauses.
[|◀◀] [▶▶] : Searches the previous/next content.
- 2 Displays the information of the current file.
Only a file name and a folder name are displayed if there is no tag information.
- 3 ▶, etc. : Playback status
↺ : Repeat playback mode indicator *
⌘ : Random playback mode indicator *
* The settings on the Bluetooth audio device are displayed.

NOTE

- Operations and display indications may differ according to their availability on the connected device.

Delete the registered Bluetooth device

- 1 Press the <MENU> button.
- 2 Touch [TEL].
- 3 Touch [📱].
- 4 Touch the device name.

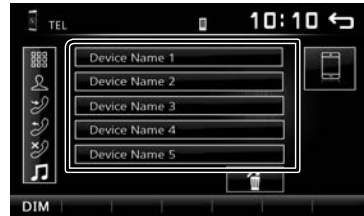

- 5 Touch [📱].

Controlling Audio

Controlling General Audio

- 1 Press the <⏏MENU> button.
- 2 Touch [Setup].
- 3 Touch [Audio].
- 4 Touch [Sound Effect].
- 5 Touch [].
- 6 Set each item as follows.

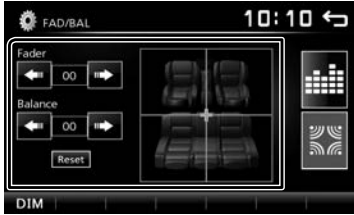

Fader	Adjust the front and rear volume balance. [◀] [▶] 12 (front) to -12 (rear)
Balance	Adjust the left and right volume balance. [◀] [▶] 12 (right) to -12 (left)
[Reset]	To clear the adjustment.

Loudness

- 1 Press the <⏏MENU> button.
- 2 Touch [Setup].
- 3 Touch [Audio].
- 4 Touch [Loudness].
Sets the amounts of boost of low and high tones.
"ON", "OFF" (Default)

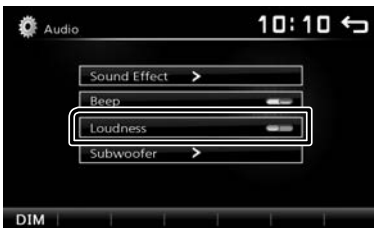

Equalizer Control

- 1 Press the <⏏MENU> button.
- 2 Touch [Setup].
- 3 Touch [Audio].
- 4 Touch [Sound Effect].
- 5 Set each item as follows.

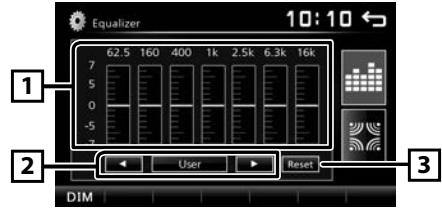

- 1 You can select frequency bar and adjust its level. (-7 to +7)
• The adjustments are stored and "User" is activated.
- 2 To recall the preset equalizer curve.
- 3 The "User" preset and the current EQ curve returns to flat.

Subwoofer settings

- 1 Press the <⏏MENU> button.
- 2 Touch [Setup].
- 3 Touch [Audio].
- 4 Touch [Subwoofer].
- 5 Set each item as follows.



Frequency [80Hz], [120Hz], [160Hz], [OFF]	Low Pass Filter adjustment. / [OFF]: Turns off the subwoofer output. (Default OFF)
Volume [-], [+]	Adjusts the subwoofer level. 0 to 12 (Default 6)

Remote control

This unit can be operated using the remote control KNA-RCDV331 (optional accessory).

⚠ CAUTION

- Put the remote control in a place where it will not move during braking or other operations. A dangerous situation could result, if the remote control falls down and gets wedged under the pedals while driving.
- Do not leave the battery near fire or under direct sunlight. A fire, explosion or excessive heat generation may result.
- Do not recharge, short, break up or heat the battery or place it in an open fire. Such actions may cause the battery to leak fluid. If spilled fluid comes in contact with your eyes or on clothing, immediately rinse with water and consult a physician.
- Place the battery out of reach of children. In the unlikely event that a child swallows the battery, immediately consult a physician.

🔋 Battery Installation

If the remote control operates only over shorter distances or does not operate at all, it is possible that the batteries are depleted.

In such instances, replace the both batteries with new ones.

- Insert two "AAA"/"R03"-size batteries with the ⊕ and ⊖ poles aligned properly, following the illustration inside the case.

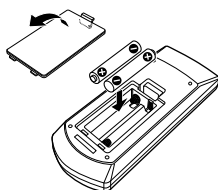

🔘 Switch the operation mode

Turn its operation mode switch to "DVD."

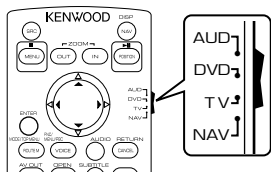

Functions of the Remote control Buttons

- Aim the remote control directly at the remote sensor on the faceplate.
- DO NOT expose the remote sensor to bright light (direct sunlight or artificial lighting).

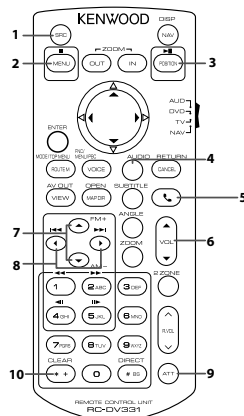

1	SRC	Switches to the source to be played.
2	■	Stop playback.
3	▶	Plays or pauses.
4	AUDIO	Displays the Equalizer screen. (P.18)
5	☎	When a call comes in, answers the call.
6	VOL ▲ ▼	Adjusts the volume.
7	FM+ AM-	Selects the folder to be played. During tuner source, select FM/ AM band to be received.
8	◀◀ ▶▶	Selects the track or file to be played. During tuner source, switches to broadcast stations received by the unit.
9	ATT	Mutes/restores the sound
10	CLEAR	Clears the telephone number input on the Phone screen.
-	Other	Not used.

Installation

Before Installation

Before installation of this unit, please note the following precautions.

▲WARNINGS

- If you connect the ignition wire (red) and the battery wire (yellow) to the car chassis (ground), you may cause a short circuit, that in turn may start a fire. Always connect those wires to the power source running through the fuse box.
- Do not cut out the fuse from the ignition wire (red) and the battery wire (yellow). The power supply must be connected to the wires via the fuse.

▲CAUTION

- Install this unit in the console of your vehicle. Do not touch the metal part of this unit during and shortly after the use of the unit. Metal part such as the heat sink and enclosure become hot.





🔧 NOTE

- Mounting and wiring this product requires skills and experience. For best safety, leave the mounting and wiring work to professionals.
- Make sure to ground the unit to a negative 12V DC power supply.
- Do not install the unit in a spot exposed to direct sunlight or excessive heat or humidity. Also avoid places with too much dust or the possibility of water splashing.
- Do not use your own screws. Use only the screws provided. If you use the wrong screws, you could damage the unit.
- If the power is not turned ON ("There is an error in the speaker wiring. Please check the connections." is displayed), the speaker wire may have a short-circuit or touched the chassis of the vehicle and the protection function may have been activated. Therefore, the speaker wire should be checked.
- If your car's ignition does not have an ACC position, connect the ignition wires to a power source that can be turned on and off with the ignition key. If you connect the ignition wire to a power source with a constant voltage supply, such as with battery wires, the battery may be drained.
- If the console has a lid, make sure to install the unit so that the front panel will not hit the lid when closing and opening.
- If the fuse blows, first make sure the wires aren't touching to cause a short circuit, then replace the old fuse with one with the same rating.
- Insulate unconnected wires with vinyl tape or other similar material. To prevent a short circuit, do not remove the caps on the ends of the unconnected wires or the terminals.

- Secure the wires with cable clamps and wrap vinyl tape around the wires that comes into contact with metal parts to protect the wires and to prevent short circuit.
- Connect the speaker wires correctly to the terminals to which they correspond. The unit may be damaged or fail to work if you share the ⊖ wires or ground them to any metal part in the car.
- When only two speakers are being connected to the system, connect the connectors either to both the front output terminals or to both the rear output terminals (do not mix front and rear). For example, if you connect the ⊕ connector of the left speaker to a front output terminal, do not connect the ⊖ connector to a rear output terminal.
- After the unit is installed, check whether the brake lamps, blinkers, wipers, etc. on the car are working properly.
- Mount the unit so that the mounting angle is 30° or less.
- Do not press hard on the panel surface when installing the unit to the vehicle. Otherwise scars, damage, or failure may result.
- Reception may drop if there are metal objects near the Bluetooth antenna.

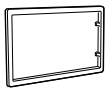

■ Supplied accessories for installation

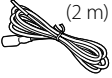
①	 x1	②	 x2
③	 x1	④	(3 m)  x1
⑤	(2 m)  x1		

Installation

Installation procedure

- 1) To prevent a short circuit, remove the key from the ignition and disconnect the ⊖ terminal of the battery.
- 2) Make the proper input and output wire connections for each unit.
- 3) Connect the wire on the wiring harness.
- 4) Take Connector B on the wiring harness and connect it to the speaker connector in your vehicle.
- 5) Take Connector A on the wiring harness and connect it to the external power connector on your vehicle.
- 6) Connect the wiring harness connector to the unit.
- 7) Install the unit in your car.
- 8) Reconnect the ⊖ terminal of the battery.
- 9) Press the reset button.

Installing the unit

Non-Japanese cars

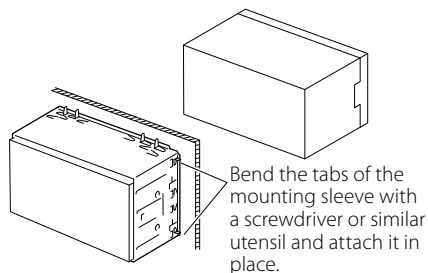

NOTE

- Make sure that the unit is installed securely in place. If the unit is unstable, it may malfunction (eg, the sound may skip).

Trim plate

- 1) Attach accessory ① to the unit.

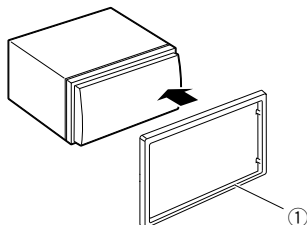

Microphone unit

- 1) Check the installation position of the microphone (accessory ④).
- 2) Clean the installation surface.
- 3) Remove the separator of the microphone (accessory ④), and stick the microphone to the place shown below.
- 4) Wire the microphone cable up to the unit with it secured at several positions using tape or other desired method.
- 5) Adjust the direction of the microphone (accessory ④) to the driver.

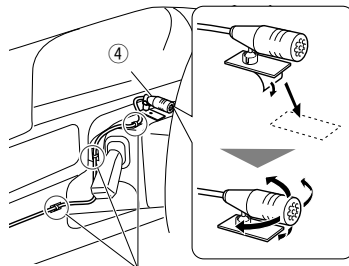

Fix a cable with a commercial item of tape.

NOTE

- Swap the clips if necessary.

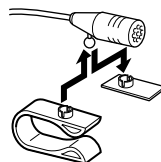

Installation

■ Removing the trim plate

- 1) Use the extraction key (accessory ③) to lever out the four tabs (two on the left part, two on the right part).

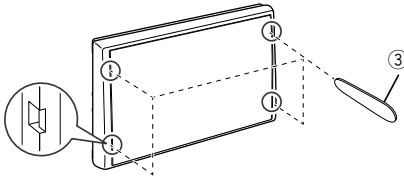

- 2) Pull the trim plate forward.

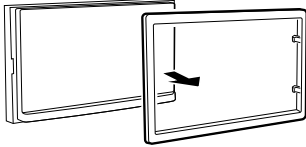

■ Removing the unit

- 1) Remove the trim plate by referring to step 1 in "Removing the trim plate".
- 2) Insert the extraction key (accessory ②) deeply into the slot as shown. (The protrusion at the tip of the extraction key must face toward the unit.)

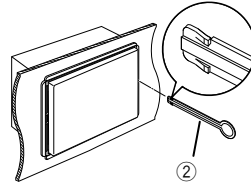

- 3) With the inserted extraction key secured, insert the other extraction key into the slot.

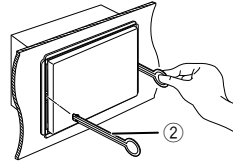

- 4) Pull out the unit halfway.

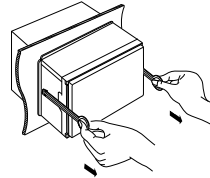

🔑 NOTE

- Be careful to avoid injury from the catch pins on the extraction key.
- 5) Pull the unit all the way out with your hands, being careful not to drop it.

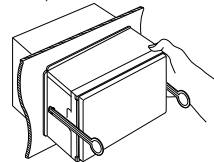

Installation

■ Connecting wires to terminals

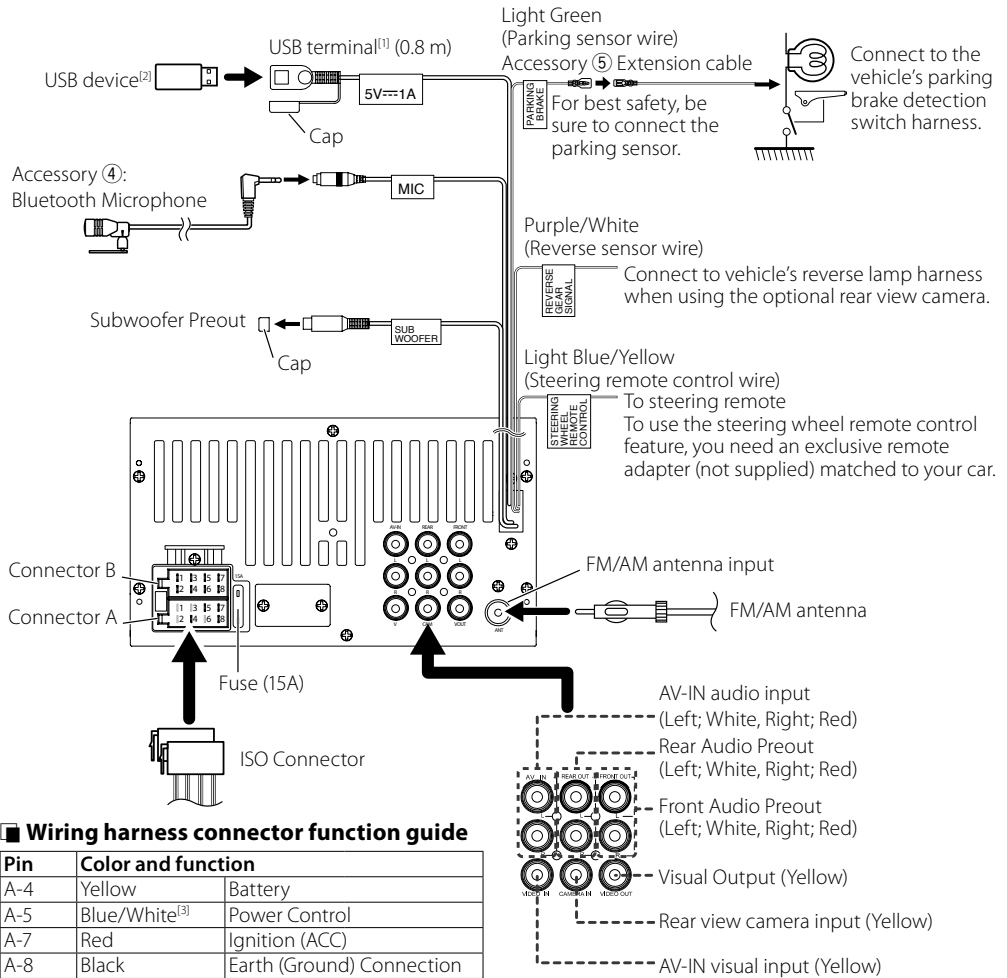

■ Wiring harness connector function guide

Pin	Color and function
A-4	Yellow Battery
A-5	Blue/White ^[3] Power Control
A-7	Red Ignition (ACC)
A-8	Black Earth (Ground) Connection
B-1/ B-2	Purple (+) / Purple/Black (-) Rear Right
B-3/ B-4	Gray (+) / Gray/Black (-) Front Right
B-5/ B-6	White (+) / White/Black (-) Front Left
B-7/ B-8	Green (+) / Green/Black (-) Rear Left

- Speaker Impedance: 4-8 Ω

⚠ CAUTION

Before you connect the commercially available ISO connectors to the unit, check the following condition:

- Make sure that the pin assignment of the connector matches with the KENWOOD unit.
- Take extra notice of the power wire.
- In case battery wire and ignition wire are not corresponding then change them accordingly.
- In case the car does not have an ignition wire, use a commercially available interface.

^[1] USB maximum power supply current : DC 5 V $\overline{\text{---}}$ 1 A

^[2] Sold separately

^[3] Max. 300mA, 12V

Installation

■ Connecting an iPod/iPhone

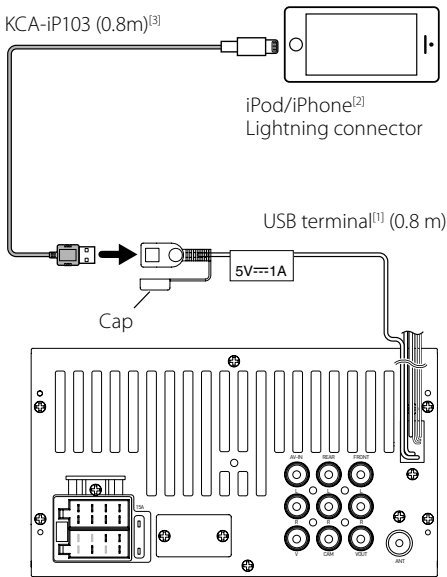

■ Connecting an Android smartphone

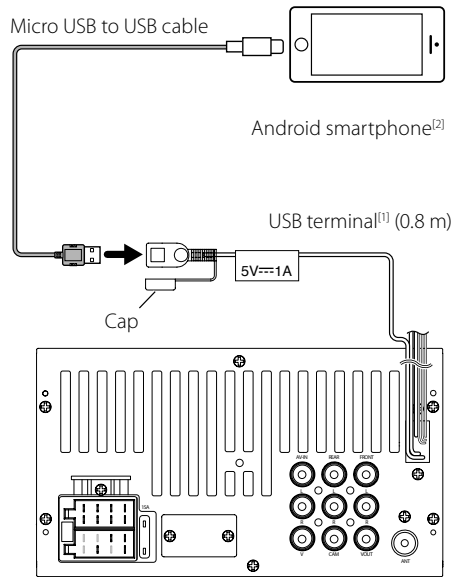

^[1] iPod/iPhone maximum power supply current :
DC 5 V = 1 A

^[2] Sold separately

^[3] Optional accessory

^[1] Android maximum power supply current :
DC 5 V = 1 A

^[2] Sold separately

About this Unit

More information

▶ Playable Audio files

Audio format	Bit rate	Sampling frequency
MP3 (.mp3)	16 – 320kbps, VBR	16 – 48 kHz
WMA (.wma)	16 – 320kbps	16 – 48 kHz
AAC-LC (.m4a)	16 – 320kbps	16 – 48 kHz
WAV (.wav)	–	16 – 192 kHz
FLAC (.flac)	–	16 – 192 kHz

- This unit can show ID3 Tag Version 1.0/1.1/2.2/2.3/2.4 (for MP3).
- The maximum number of characters:
 - Tag : 30 characters

🔑 NOTE

- WMA and AAC of which is covered with DRM cannot be played.
- Although the audio files are complied with the standards listed above, the play may be impossible depending on the types or conditions of media or device.

▶ Acceptable Video files

Video format	Video codec	Audio codec
MPEG-1 (.mpeg, .mpe)	MPEG-1	MPEG Audio Layer 2
MPEG-2 (.mpg, .mpeg)	MPEG-2	MPEG Audio Layer 2
MPEG-4 (.mp4, .avi)	MPEG-4	MP3, AAC-LC (2ch)
H.264 (.mp4, mkv, avi, flv, f4v)	H.264	MP3, AAC
MKV (.mkv)	H.264 / MPEG-4 AVC, MPEG4, WMV (VC1)	MP3, AAC, WMA, Vorbis, FLAC
WMV (.wmv)	WMV (VC1)	WMA

▶ Acceptable Picture files

- JPEG (.jpg)
 - 32 x 32 to 16,241 x 15,225 (JPEG) or 5,847 x 5,481 (Progressive JPEG)
 - It may take time to display the file.
 - Lossless JPEG files cannot be played.
- BMP (.bmp)
 - 32 x 32 to 9,873 x 9,873 resolution
 - It may take time to display the file.
- PNG (.png)
 - 32 x 32 to 8,192 x 7,680
 - It may take time to display the file.

Troubleshooting

What appears to be trouble is not always serious. Check the following points before calling a service center.

- For operations with the external components, refer also to the instructions supplied with the adapters used for the connections (as well as the instructions supplied with the external components).

▶ General

No sound comes out of the speakers.

- Adjust the volume to the optimum level.
- Check the cords and connections.

The unit does not work at all.

- Reset the unit. **(P.2)**

The remote controller does not work.

- Replace the battery.

▶ USB

While playing a track, sound is sometimes interrupted.

- The tracks are not properly copied into the USB device. Copy the tracks again, and try again.

▶ iPod/iPhone

No sound comes out of the speakers.

- Disconnect the iPod/iPhone, then connect it again.
- Select another source, then reselect “iPod”.

The iPod/iPhone does not turn on or does not work.

- Check the connecting cable and its connection.
- Update the firmware version of iPod/iPhone.
- Charge the battery of iPod/iPhone.
- Reset the iPod/iPhone.

Sound is distorted.

- Deactivate the equalizer either on this unit or the iPod/iPhone.

A lot of noise is generated.

- Turn off (uncheck) “VoiceOver” on the iPod/iPhone. For details, visit <<http://www.apple.com>>.

▶ Radio

Automatic presetting does not work.

- Store stations manually. **(P.12)**

Static noise while listening to the radio.

- Connect the antenna firmly.

About this Unit

AV-IN

No picture appears on the screen.

- Turn on the video component if it is not on.
- Connect the video component correctly.

Bluetooth

Phone sound quality is poor.

- Reduce the distance between the unit and the Bluetooth mobile phone.
- Move the car to a place where you can get a better signal reception.

The sound is interrupted or skipped while using a Bluetooth audio player.

- Reduce the distance between the unit and the Bluetooth audio player.
- Turn off, then turn on the unit. (When the sound is not yet restored) connect the player again.

The connected audio player cannot be controlled.

- Check whether the connected audio player supports AVRCP (Audio/Video Remote Control Profile).

The Bluetooth device does not detect the unit.

- Search from the Bluetooth device again.

The unit does not pair with the Bluetooth device.

- Turn off, then turn on the Bluetooth device.
- Disconnect the Bluetooth device currently connected and then register the new device. **(P.15)**

Remote control

KNA-RCDV331 (optional accessory) cannot control the unit.

- Turn its operation mode switch to "DVD."

Copyrights

- The Bluetooth word mark and logos are registered trademarks owned by the Bluetooth SIG, Inc. and any use of such marks by JVC KENWOOD Corporation is under license. Other trademarks and trade names are those of their respective owners.
- Use of the Made for Apple badge means that an accessory has been designed to connect specifically to the Apple product(s) identified in the badge, and has been certified by the developer to meet Apple performance standards. Apple is not responsible for the operation of this device or its compliance with safety and regulatory standards. Please note that the use of this accessory with an Apple product may affect wireless performance.
- Apple, iPhone, iPod, and Lightning are trademarks of Apple Inc., registered in the U.S. and other countries.
- The "AAC" logo is a trademark of Dolby Laboratories.
- Microsoft and Windows Media are either registered trademarks or trademarks of Microsoft Corporation in the United States and/or other countries.
- Android is a trademark of Google LLC.
- THIS PRODUCT IS LICENSED UNDER THE AVC PATENT PORTFOLIO LICENSE FOR THE PERSONAL USE OF A CONSUMER OR OTHER USES IN WHICH IT DOES NOT RECEIVE REMUNERATION TO (i) ENCODE VIDEO IN COMPLIANCE WITH THE AVC STANDARD ("AVC VIDEO") AND/OR (ii) DECODE AVC VIDEO THAT WAS ENCODED BY A CONSUMER ENGAGED IN A PERSONAL ACTIVITY AND/OR WAS OBTAINED FROM A VIDEO PROVIDER LICENSED TO PROVIDE AVC VIDEO. NO LICENSE IS GRANTED OR SHALL BE IMPLIED FOR ANY OTHER USE. ADDITIONAL INFORMATION MAY BE OBTAINED FROM MPEG LA, L.L.C. SEE [HTTP://WWW.MPEGLA.COM](http://www.MPEGLA.COM)
- THIS PRODUCT IS LICENSED UNDER THE MPEG-4 VISUAL PATENT PORTFOLIO LICENSE FOR THE PERSONAL AND NON-COMMERCIAL USE OF A CONSUMER FOR (i) ENCODING VIDEO IN COMPLIANCE WITH THE MPEG-4 VISUAL STANDARD ("MPEG-4 VIDEO") AND/OR (ii) DECODING MPEG-4 VIDEO THAT WAS ENCODED BY A CONSUMER ENGAGED IN A PERSONAL AND NON-COMMERCIAL ACTIVITY AND/OR WAS OBTAINED FROM A VIDEO PROVIDER LICENSED BY MPEG LA TO PROVIDE MPEG-4 VIDEO. NO LICENSE IS GRANTED OR SHALL BE IMPLIED FOR ANY OTHER USE. ADDITIONAL INFORMATION INCLUDING THAT RELATING TO PROMOTIONAL, INTERNAL AND COMMERCIAL USES AND LICENSING MAY BE OBTAINED FROM MPEG LA, LLC. SEE [HTTP://WWW.MPEGLA.COM](http://www.MPEGLA.COM)
- THIS PRODUCT IS LICENSED UNDER THE VC-1 PATENT PORTFOLIO LICENSE FOR THE PERSONAL AND NON-COMMERCIAL USE OF A CONSUMER TO (i) ENCODE VIDEO IN COMPLIANCE WITH THE VC-1 STANDARD ("VC-1 VIDEO") AND/OR (ii) DECODE VC-1 VIDEO THAT WAS ENCODED BY A CONSUMER ENGAGED IN A PERSONAL AND NON-COMMERCIAL ACTIVITY AND/OR WAS OBTAINED FROM A VIDEO PROVIDER LICENSED TO PROVIDE VC-1 VIDEO. NO LICENSE IS GRANTED OR SHALL BE IMPLIED FOR ANY OTHER USE. ADDITIONAL INFORMATION MAY BE OBTAINED FROM MPEG LA, L.L.C. SEE [HTTP://WWW.MPEGLA.COM](http://www.MPEGLA.COM)

About this Unit

- libFLAC
Copyright (C) 2000-2009 Josh Coalson
Copyright (C) 2011-2013 Xiph.Org Foundation
Redistribution and use in source and binary forms, with or without modification, are permitted provided that the following conditions are met:
 - Redistributions of source code must retain the above copyright notice, this list of conditions and the following disclaimer.
 - Redistributions in binary form must reproduce the above copyright notice, this list of conditions and the following disclaimer in the documentation and/or other materials provided with the distribution.
 - Neither the name of the Xiph.org Foundation nor the names of its contributors may be used to endorse or promote products derived from this software without specific prior written permission.

THIS SOFTWARE IS PROVIDED BY THE COPYRIGHT HOLDERS AND CONTRIBUTORS ``AS IS'' AND ANY EXPRESS OR IMPLIED WARRANTIES, INCLUDING, BUT NOT LIMITED TO, THE IMPLIED WARRANTIES OF MERCHANTABILITY AND FITNESS FOR A PARTICULAR PURPOSE ARE DISCLAIMED. IN NO EVENT SHALL THE FOUNDATION OR CONTRIBUTORS BE LIABLE FOR ANY DIRECT, INDIRECT, INCIDENTAL, SPECIAL, EXEMPLARY, OR CONSEQUENTIAL DAMAGES (INCLUDING, BUT NOT LIMITED TO, PROCUREMENT OF SUBSTITUTE GOODS OR SERVICES; LOSS OF USE, DATA, OR PROFITS; OR BUSINESS INTERRUPTION) HOWEVER CAUSED AND ON ANY THEORY OF LIABILITY, WHETHER IN CONTRACT, STRICT LIABILITY, OR TORT (INCLUDING NEGLIGENCE OR OTHERWISE) ARISING IN ANY WAY OUT OF THE USE OF THIS SOFTWARE, EVEN IF ADVISED OF THE POSSIBILITY OF SUCH DAMAGE.

About this Unit

Specifications

Monitor section

Picture Size

- : 6.75 inches (diagonal) wide
- : 151.8 mm (W) × 79.7 mm (H)

Display System

- : Transparent TN LCD panel

Drive System

- : TFT active matrix system

Number of Pixels

- : 1,152,000 (800H × 480V × RGB)

Effective Pixels

- : 99.99 %

Pixel Arrangement

- : RGB striped arrangement

Back Lighting

- : LED

USB interface section

USB Standard

- : USB 2.0 High Speed

File System

- : FAT 16/ 32

Maximum Power Supply Current

- : DC 5 V $\overline{\text{---}}$ 1 A

D/A Converter

- : 24 Bit

Audio Decoder

- : MP3/ WMA/ WAV/ AAC/ FLAC

Video Decoder

- : MPEG1/ MPEG2/ MPEG4/ H.264/ MKV/ WMV

Frequency Response

- 192 kHz : 20 – 20,000 Hz
- 96 kHz : 20 – 20,000 Hz
- 48 kHz : 20 – 20,000 Hz
- 44.1 kHz : 20 – 20,000 Hz

Bluetooth section

Technology

- : Bluetooth Ver.2.1 + EDR

Frequency

- : 2.402 – 2.480 GHz

Output Power

- : +4 dBm (MAX), Power Class2

Maximum Communication range

- : Line of sight approx. 10m (32.8 ft)

Audio Codec

- : SBC

Profile (Multi Profile support)

- HFP (V1.6) (Hands Free Profile)
- A2DP (V1.2) (Advanced Audio Distribution Profile)
- AVRCP (V1.3) (Audio/Video Remote Control Profile)
- PBAP (V1.1.1) (Phonebook Access Profile)

FM tuner section

Frequency Range (step)

- : 87.5 MHz – 108.0 MHz (50 kHz)

Usable Sensitivity

- : 12.2 dBf
- : 1.1 $\mu\text{V}/75 \Omega$, S/N : 30 dB

Frequency Response

- : 30 Hz – 14 kHz

S/N Ratio (dB)

- : 55 dB (MONO)

Selectivity (\pm 400 kHz)

- : Over 70 dB

Stereo Separation

- : 37 dB (1 kHz)

AM tuner section

Frequency Range (step)

- : 531 – 1611 kHz (9 kHz)

Usable Sensitivity

- : 29 μV

Video section

Color System of External Video Input

- : NTSC/PAL

External Video Input Level (RCA jacks)

- : 1.0 V_{p-p}/ 75 Ω

External Audio Max Input Level (RCA jacks)

- : 1.8 V/ 10 k Ω

Video Output Level (RCA jacks)

- : 1.0 V_{p-p}/ 75 Ω

NOTE

- Although the effective pixels for the liquid crystal panel is given as 99.99% or more, 0.01% of pixels may not light or may light incorrectly.
- Specifications subject to change without notice.

About this Unit

Audio section

Maximum Power (Front & Rear)

: 50 W × 4

Full Bandwidth Power (Front & Rear)

Full Bandwidth Power (at less than 1% THD)

: 21 W × 4

Preout Level (V)

: 2 V / 10 kΩ

Preout Impedance

: ≤ 600 Ω

Speaker Impedance

: 4 – 8 Ω

Equalizer

: 7 Band

Band

Frequency: 62.5/ 160/ 400/ 1k/ 2.5k/ 6.3k/ 16k Hz

Level: -7 – +7 (-7 dB – +7 dB)

LPF

Frequency: 80/ 120/ 160 Hz/ Off

General

Operating Voltage

: 12 V DC car battery

Installation Dimensions (W × H × D)

: 182 × 112 × 75 mm

Main Unit Installation size (W × H × D)

: 178 × 100 × 75 mm (w/o sleeve)

Weight

: 1.1 kg

(Including Mounting Sleeve and Trim plate)

Information on Disposal of Old Electrical and Electronic Equipment and Batteries (applicable for EU countries that have adopted separate waste collection systems)

Products and batteries with the symbol (crossed-out wheeled bin) cannot be disposed as household waste. Old electrical and electronic equipment and batteries should be recycled at a facility capable of handling these items and their waste byproducts.

Contact your local authority for details in locating a recycle facility nearest to you.

Proper recycling and waste disposal will help conserve resources whilst preventing detrimental effects on our health and the environment.

Notice: The sign "Pb" below the symbol for batteries indicates that this battery contains lead.

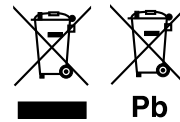

For Israel

מידע בדבר השלכה לאשפה של ציוד חשמלי ואלקטרוני יישן וכן סוללות (רלוונטי למדינות שמשמשות במערכת איסוף אשפה מופרדת).

לא ניתן להשליך מוצרים וסוללות עם הסימון (פח אשפה עם X עליו) כאשפה ביתית רגילה.

יש למחזר ציוד חשמלי ואלקטרוני יישן וכן סוללות במתקן המסוגל לטפל בפרטים כאלה ובתוצרי הלוואי שלהם.

צרו קשר עם הרשות המקומית לקבלת פרטים אודות מתקן המיחזור הקרוב אליכם. מיחזור והשלכה לאשפה נאותים יעזרו לשמר משאבים ולמנוע השפעות שליליות על בריאותנו ועל הסביבה.

שימו לב: הסימון Pb שמתחת לסימון עבר סוללות מציינ שהסוללה מכילה עופרת.

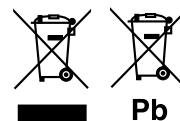



Declaration of Conformity with regard to the RE Directive 2014/53/EU
Declaration of Conformity with regard to the RoHS Directive 2011/65/EU

Manufacturer:

JVC KENWOOD Corporation
3-12, Moriyacho, Kanagawa-ku, Yokohama-shi, Kanagawa 221-0022, JAPAN

EU Representative:

JVCKENWOOD Europe B.V.
Amsterdamseweg 37, 1422 AC UITHOORN, THE NETHERLANDS

English

Hereby, JVC KENWOOD declares that the radio equipment DMX120BT is in compliance with Directive 2014/53/EU. The full text of the EU declaration of conformity is available at the following internet address:

Français

Par la présente, JVC KENWOOD déclare que l'équipement radio DMX120BT est conforme à la directive 2014/53/UE. L'intégralité de la déclaration de conformité UE est disponible à l'adresse Internet suivante :

Deutsch

Hiernit erklärt JVC KENWOOD, dass das Funkgerät DMX120BT der Richtlinie 2014/53/EU entspricht. Der volle Text der EU-Konformitätserklärung steht unter der folgenden Internetadresse zur Verfügung:

Nederlands

Hierbij verklaart JVC KENWOOD dat de radioapparatuur DMX120BT in overeenstemming is met Richtlijn 2014/53/UE. De volledige tekst van de EU-verklaring van overeenstemming is te vinden op het volgende internetadres:

Italiano

Con la presente, JVC KENWOOD dichiara che l'apparecchio radio DMX120BT è conforme alla Direttiva 2014/53/UE. Il testo integrale della dichiarazione di conformità UE è disponibile al seguente indirizzo internet:

Español

Por la presente, JVC KENWOOD declara que el equipo de radio DMX120BT cumple la Directiva 2014/53/UE. El texto completo de la declaración de conformidad con la UE está disponible en la siguiente dirección de internet:

Português

Deste modo, a JVC KENWOOD declara que o equipamento de rádio DMX120BT está em conformidade com a Diretiva 2014/53/UE. O texto integral da declaração de conformidade da UE está disponível no seguinte endereço de internet:

Polska

Niniejszym, JVC KENWOOD deklaruje, że sprzęt radiowy DMX120BT jest zgodny z dyrektywą 2014/53/UE. Pełny tekst deklaracji zgodności EU jest dostępny pod adresem:

Český

Společnost JVC KENWOOD tímto prohlašuje, že rádiové zařízení DMX120BT splňuje podmínky směrnice 2014/53/EU. Plný text EU prohlášení o shodě je dostupný na následující internetové adrese:

Magyar

JVC KENWOOD ezennel kijelenti, hogy a DMX120BT rádióberendezés megfelel a 2014/53/EU irányelvnek. Az EU konformitási nyilatkozat teljes szövege az alábbi weboldalon érhető el:

Hrvatski

JVC KENWOOD ovim izjavljuje da je radio oprema DMX120BT u skladu s Direktivom 2014/53/EU. Cjeloviti tekst deklaracije Europske unije o usklađenosti dostupan je na sljedećoj internet adresi:

Svenska

Härmed försäkras JVC KENWOOD att radioutrustningen DMX120BT är i enlighet med direktiv 2014/53 / EU. Den fullständiga texten av EU-försäkran om överensstämmelse finns på följande Internetadress :

Suomi

JVC KENWOOD julistaa täten, että radiolaitte DMX120BT on direktiivin 2014/53/ EU mukainen. EU-vaatimustenmukaisuusvakuutus löytyy kokonaisuudessaan seuraavasta internet-osoitteesta:

Slovensky

Stem JVC KENWOOD izjavlja, da je radijska oprema DMX120BT v skladu z Direktivo 2014/53/EU. Celotno besedilo direktive EU o skladnosti je dostopno na tem spletnem naslovu:

Slovensky

Spoločnosť JVC KENWOOD týmto vyhlasuje, že rádiové zariadenie DMX120BT vyhovuje smernici 2014/53/EÚ. Celý text EÚ vyhlásenia o zhode nájdete na nasledovnej internetovej adrese:

Dansk

Herved erklærer JVC KENWOOD, at radioudstyret DMX120BT er i overensstemmelse med Direktiv 2014/53/EE. EU-overensstemmelsestærklæringsens fulde ordlyd er tilgængelig på følgende internetadresse:

Norsk

JVC KENWOOD erklærer herved at radioustyret DMX120BT er i samsvar med Direktiv 2014/53/UE. Den fullstendige teksten til EU-konformitetserklæringen er tilgjengelig på følgende internetadresse:

Ελληνικά

Με το παρόν, η JVC KENWOOD δηλώνει ότι ο ραδιοεξοπλισμός DMX120BT συμμορφώνεται με την Οδηγία 2014/53/ΕΕ. Το πλήρες κείμενο της δήλωσης συμμόρφωσης της ΕΕ είναι διαθέσιμο στην ακόλουθη διεύθυνση στο διαδίκτυο:

Eesti

Käesolevaga JVC KENWOOD kinnitab, et DMX120BT raadiovarustus on vastavuses direktiiviga 2014/53/EL. Eli vastavusdeklaratsiooni terviktekst on kättesaadav järgmisel internetiaadressil:

Latvisū

JVC KENWOOD ar šo deklarē, ka radio aparātūra DMX120BT atbilst direktīvas 2014/53/ES prasībām. Pilns ES atbilstības deklarācijas teksts ir pieejams šādā tīmekļa adresē:

Lietuviška

Šiuo JVC KENWOOD pažymi, kad radijo įranga DMX120BT atitinka 2014/53/EB direktyvos reikalavimus. Visą EB atbilstības deklarācijas tekstą galite rasti šiuo internetiniu adresu:

Malti

B'dan, JVC KENWOOD jiddikjara li t-tagħmir tar-radju DMX120BT huwa konformi mad-Direttiva 2014/53/UE. It-test kollu tad-dikjarazzjoni ta' konformità huwa disponibbli fl-indrizz intranet li ġej:

Українська

Таким чином, компанія JVC KENWOOD заявляє, що радіобладнання DMX120BT відповідає Директиві 2014/53/ЕВ. Повний текст декларації про відповідність ЄС можна знайти в Інтернеті за такою адресою:

Türkçe

Burada, JVC KENWOOD DMX120BT radyo ekipmanının 2014/53/AB Direktifine uygun olduğunu bildirir. AB uyumluluk deklarasyonunun tam metni aşağıdaki internet adresinde mevcuttur.

Русский

JVC KENWOOD настоящим заявляет, что радиооборудование DMX120BT соответствует Директиве 2014/53/ЕВ. Полный текст декларации соответствия ЕС доступен по следующему адресу в сети Интернет:

Limba română

Prin prezenta, JVC KENWOOD declară că echipamentul radio DMX120BT este în conformitate cu Directiva 2014/53/UE. Textul integral al declarației de conformitate UE este disponibil la următoarea adresă de internet:

Български език

С настоящото JVC KENWOOD декларира, че радиооборудването на DMX120BT е в съответствие с Директива 2014/53/ЕС. Пълният текст на ЕС декларацията за съответствие е достъпен на следния интернет адрес:

URL: <http://www.kenwood.com/cs/ce/eudoc/>

KENWOOD