

# KENWOOD

# INSTRUCTION MANUAL



ALL MODE MULTI-BAND TRANSCEIVER

# TS-2000

# TS-2000X

# TS-B2000

### NOTIFICATION

This equipment complies with the essential requirements of Directive 2014/53/EU. This equipment requires a licence and is intended for use in the countries below.

AT	BE	DK	FI	FR	DE	GR	IS	IE
IT	LI	LU	NL	NO	PT	ES	SE	CH
GB	CY	CZ	EE	HU	LV	LT	MT	PL
SK	SI	BG	RO	HR	TR			

ISO3166

JVCKENWOOD Corporation

B62-1221-70 (K, E)





## THANK YOU

Thank you for choosing this **KENWOOD** TS-2000(X)/TS-B2000 transceiver. It has been developed by a team of engineers determined to continue the tradition of excellence and innovation in **KENWOOD** transceivers.

This transceiver features dual Digital Signal Processing (DSP) units to process IF and AF signals. By taking maximum advantage of DSP technology, the TS-2000(X)/TS-B2000 gives you enhanced interference reduction capabilities and improves the quality of audio that you transmit without installing additional analog filters. You will notice the differences when you fight QRM and QRN. As you learn how to use this transceiver, you will also find that **KENWOOD** is pursuing "user friendliness". For example, each time you change the Menu No. in Menu mode, you will see scrolling messages on the display that tell you what you are selecting.

Though user friendly, this transceiver is technically sophisticated and some features may be new to you. Consider this manual to be a personal tutorial from the designers. Allow the manual to guide you through the learning process now, then act as a reference in the coming years.

## FEATURES

- All mode operation from HF to 1.2 GHz (TS-2000/TS-B2000 Optional) amateur radio band with DSP functions.
- Dual high speed Digital Signal Processing (DSP) units.
- Adjustable DSP filter frequencies.
- High speed Digital Automatic Gain Control (AGC).
- A second independent sub-receiver for the 144 MHz and 430 (440) MHz bands (FM and AM mode only).
- A built-in Antenna Tuner for HF/ 50 MHz band.
- A built-in 9600/ 1200 bps TNC for DX Packet Cluster Tune (P.C.T.) and Sky Command II+ operations.
- DX Packet Cluster Tune (P.C.T.) for DX hunting.
- Instant Satellite communication key.
- A razor sharp DSP filter up to 50 Hz for CW operation.

## SUPPLIED ACCESSORIES

After carefully unpacking the transceiver, identify the items listed in the table. We recommend you keep the box and packing material below in case you need to repack the transceiver in the future.

Accessory	Part Number	Quantity	
		TS-2000 TS-2000X	TS-B2000
Microphone	T91-0352-XX	1	1
DC power cable	E30-3157-XX	1	1
7-pin DIN plug	E07-0751-XX	1	1
8-pin DIN plug	E07-0851-XX	1	1
13-pin DIN plug	E07-1351-XX	1	1
Fuse (25A)	F05-2531-XX	1	1
Fuse (4A)	F06-4027-XX	1	1
Screw Set	N99-2024-XX	1	1
Spacer for MB-430	G11-2698-XX	4	4
Line filter <sup>1</sup>	L79-1408-XX	1	1
Retaining Band <sup>1</sup>	J61-0307-XX	1	1
CD-ROM	T93-0123-XX	–	1
Instruction Manual	B62-1221-XX	1	1
Schematic/ Block Diagrams	B52-0614-XX B52-0616-XX B52-0617-XX	1	1
Warranty card	–	1	1

<sup>1</sup> E and E2-type only

## WRITING CONVENTIONS FOLLOWED

The writing conventions described below have been followed to simplify instructions and avoid unnecessary repetition.

Instruction	What to Do
Press <b>[KEY]</b> .	Press and release <b>KEY</b> .
Press <b>[KEY1]+[KEY2]</b> .	Press and hold <b>KEY1</b> down, then press <b>KEY2</b> . If there are more than two keys, press and hold down each key in turn until the final key has been pressed.
Press <b>[KEY1], [KEY2]</b> .	Press <b>KEY1</b> momentarily, release <b>KEY1</b> , then press <b>KEY2</b> .
Press <b>[KEY]+[ϕ]</b> .	With the transceiver power OFF, press and hold <b>KEY</b> , then switch ON the transceiver power by pressing <b>[ϕ]</b> (POWER).

## MODELS COVERED BY THIS MANUAL

The models listed below are covered by this manual.

**TS-2000:** HF/ VHF/ UHF All-mode Multi-band Transceiver

**TS-2000X:** HF/ VHF/ UHF/ 1.2 GHz All-mode Multi-band Transceiver

**TS-B2000:** HF/ VHF/ UHF All-mode Multi-band Transceiver

As for TS-B2000, refer to the on-line help for information on how to operate and control the transceiver. Refer to pages 2, 3, and 13 for the installation and information on the connectors.

## MARKET CODES

**K-type:** The Americas

**E-type:** Europe

**E2-type:** Spain

The market code is shown on the carton box.

Refer to the specifications {page 105} for the information on available operating frequencies.

### Information on Disposal of Old Electrical and Electronic Equipment and Batteries (applicable for countries that have adopted separate waste collection systems)

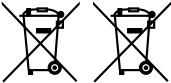

Products and batteries with the symbol (crossed-out wheeled bin) cannot be disposed as household waste.

Old electrical and electronic equipment and batteries should be recycled at a facility capable of handling these items and their waste byproducts.

Contact your local authority for details in locating a recycle facility nearest to you.

Proper recycling and waste disposal will help conserve resources whilst preventing detrimental effects on our health and the environment.

### Eski Elektrikli ve Elektronik Cihazların ve Pillerin İmhası Hakkında Bilgi (ayrı atık toplama sistemlerine sahip olan ülkelerde geçerlidir)



Bu sembolü (üzeri çizili çöp bidonu) içeren ürün ve piller evsel atık çöpleri ile birlikte atılamaz.

Kullanılmış elektrikli ve elektronik cihaz ve piller, bu tür maddeleri ve bunların yan ürünlerini işleme elverişli bir geri kazanım tesisine gönderilmelidir.

Size en yakın geri kazanım tesisinin konumunu öğrenmek üzere yerel yetkililerinize danışın. Doğru geri kazanım ve atık uzaklaştırma yöntemleri, sadece öz kaynakların korunmasına yardımcı olmakla kalmayıp ayrıca sağlığınıza ve çevreye olacak zararlı etkilerini engellemeye yardımcı olur.

Bu ürün 28300 sayılı Resmî Gazete'de yayımlanan Atık Elektrikli ve Elektronik Eşyaların Kontrolü Yönetmeliğe uygun olarak üretilmiştir.

## NOTICE TO THE USER

One or more of the following statements may be applicable for this equipment.

### FCC WARNING

*This equipment generates or uses radio frequency energy. Changes or modifications to this equipment may cause harmful interference unless the modifications are expressly approved in the instruction manual. The user could lose the authority to operate this equipment if an unauthorized change or modification is made.*

### INFORMATION TO THE DIGITAL DEVICE USER REQUIRED BY THE FCC

*This equipment has been tested and found to comply with the limits for a Class B digital device, pursuant to Part 15 of the FCC Rules. These limits are designed to provide reasonable protection against harmful interference in a residential installation.*

*This equipment generates, uses and can generate radio frequency energy and, if not installed and used in accordance with the instructions, may cause harmful interference to radio communications. However, there is no guarantee that the interference will not occur in a particular installation. If this equipment does cause harmful interference to radio or television reception, which can be determined by turning the equipment off and on, the user is encouraged to try to correct the interference by one or more of the following measures:*

- Reorient or relocate the receiving antenna.
- Increase the separation between the equipment and receiver.
- Connect the equipment to an outlet on a circuit different from that to which the receiver is connected.
- Consult the dealer for technical assistance.

This product contains a CR Coin Cell Lithium Battery which contains Perchlorate Material – special handling may apply.

See [www.dtsc.ca.gov/hazardouswaste/perchlorate](http://www.dtsc.ca.gov/hazardouswaste/perchlorate)

# PRECAUTIONS

Please observe the following precautions to prevent fire, personal injury, and transceiver damage:

- Connect the transceiver only to a power source described in this manual or as marked on the transceiver itself.
- Route all power cables safely. Ensure the power cables can neither be stepped upon nor pinched by items placed near or against the cables. Pay particular attention to locations near AC receptacles, AC outlet strips, and points of entry to the transceiver.
- Take care not to drop objects or spill liquid into the transceiver through enclosure openings. Metal objects, such as hairpins or needles, inserted into the transceiver may contact voltages resulting in serious electrical shocks. Never permit children to insert any objects into the transceiver.
- Do not attempt to defeat methods used for grounding and electrical polarization in the transceiver, particularly involving the power input cable.
- Adequately ground all outdoor antennas for this transceiver using approved methods. Grounding helps protect against voltage surges caused by lightning. It also reduces the chance of a build-up of static charge.

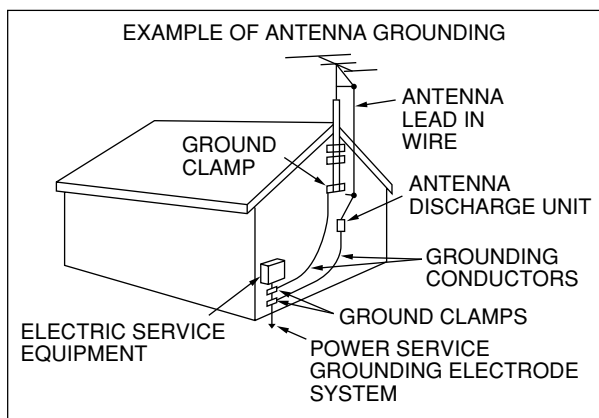

- Minimum recommended distance for an outdoor antenna from power lines is one and one-half times the vertical height of the associated antenna support structure. This distance allows adequate clearance from the power lines if the support structure fails for any reason.
- Locate the transceiver so as not to interfere with its ventilation. Do not place books or other equipment on the transceiver that may impede the free movement of air. Allow a minimum of 4 inches (10 cm) between the rear of the transceiver and the wall or operating desk shelf.
- Do not use the transceiver near water or sources of moisture. For example, avoid use near a bathtub, sink, swimming pool, or in a damp basement or attic.
- The presence of an unusual odor or smoke is often a sign of trouble. Immediately turn the power OFF and remove the power cable. Contact a **KENWOOD** service station or your dealer for advice.

- Locate the transceiver away from heat sources such as a radiator, stove, amplifier or other devices that produce substantial amounts of heat.
- Do not use volatile solvents such as alcohol, paint thinner, gasoline or benzene to clean the cabinet of the transceiver. Use a clean cloth with warm water or a mild detergent.
- Disconnect the input power cable from the power source when the transceiver is not used for long periods of time.
- Remove the transceiver's enclosure only to do accessory installations described in this manual or accessory manuals. Follow provided instructions carefully, to avoid electrical shocks. If unfamiliar with this type of work, seek assistance from an experienced individual, or have a professional technician do the task.
- Enlist the services of qualified personnel in the following cases:
  - a) The power supply or plug is damaged.
  - b) Objects have fallen or liquid has spilled into the transceiver.
  - c) The transceiver has been exposed to rain.
  - d) The transceiver is operating abnormally or performance has seriously degraded.
  - e) The transceiver has been dropped or the enclosure damaged.

# CONTENTS

THANK YOU .....	i
FEATURES .....	i
SUPPLIED ACCESSORIES .....	i
WRITING CONVENTIONS FOLLOWED .....	i
MODELS COVERED BY THIS MANUAL .....	ii
MARKET CODES .....	ii
NOTICE TO USER .....	ii
PRECAUTIONS .....	iii
CONTENTS .....	iv

## CHAPTER 1 INSTALLATION

ANTENNA CONNECTION .....	1
GROUND CONNECTION .....	1
LIGHTNING PROTECTION .....	1
DC POWER SUPPLY CONNECTION .....	2
UTILIZING THE BAIL (TS-2000 (X) ONLY) .....	2
REPLACING FUSES .....	2
ACCESSORY CONNECTIONS .....	3
FRONT PANEL .....	3
Headphones (PHONES) .....	3
Microphone (MIC) .....	3
REAR PANEL .....	3
External Speakers (EXT.SP1/ EXT.SP2) .....	3
Keys for CW (PADDLE and KEY) .....	3

## CHAPTER 2 YOUR FIRST QSO (HF/ 50MHz band)

RECEIVING .....	4
TRANSMITTING .....	5

## CHAPTER 3 YOUR FIRST QSO (VHF/ UHF band)

RECEIVING .....	6
TRANSMITTING .....	7

## CHAPTER 4 GETTING ACQUAINTED

FRONT PANEL .....	8
REAR PANEL .....	13
DISPLAY .....	14
MICROPHONE .....	17

## CHAPTER 5 OPERATING BASICS

SWITCHING POWER ON/OFF .....	18
ADJUSTING VOLUME .....	18
AUDIO FREQUENCY (AF) GAIN .....	18
RADIO FREQUENCY (RF) GAIN .....	18
SELECTING VFO A OR VFO B .....	18
SELECTING A BAND .....	18
SELECTING A MODE .....	19
ADJUSTING SQUELCH .....	19
SELECTING A FREQUENCY .....	19
FRONT PANEL METER .....	19
TRANSMITTING .....	20
SELECTING TRANSMIT POWER .....	20
MICROPHONE GAIN .....	20

## CHAPTER 6 MENU SETUP

WHAT IS A MENU? .....	21
MENU A/ MENU B .....	21
MENU ACCESS .....	21

QUICK MENU .....	21
PROGRAMMING THE QUICK MENU .....	21
USING THE QUICK MENU .....	21
MENU CONFIGURATION .....	22
ALPHABETICAL FUNCTION LIST .....	26

## CHAPTER 7 BASIC COMMUNICATIONS

SSB TRANSMISSION .....	28
FM TRANSMISSION .....	28
AM TRANSMISSION .....	29
NARROW BANDWIDTH FOR FM .....	29
NARROW BANDWIDTH FOR AM .....	29
CW TRANSMISSION .....	30
AUTO ZERO-BEAT .....	30
TX SIDETONE/ RX PITCH FREQUENCY .....	30

## CHAPTER 8 ENHANCED COMMUNICATIONS

SPLIT-FREQUENCY OPERATION .....	31
TF-SET (TRANSMIT FREQUENCY SET) .....	31
FM REPEATER OPERATION .....	32
PROGRAMMING AN OFFSET .....	32
Selecting an Offset Direction .....	32
Selecting an Offset Frequency .....	32
TRANSMITTING A TONE .....	33
Activating the Tone Function .....	33
Selecting a Tone Frequency .....	33
Selecting Continuous or Burst .....	33
Transmitting a 1750 Hz Tone .....	33
AUTOMATIC REPEATER OFFSET .....	34
REVERSE FUNCTION .....	34
AUTOMATIC SIMPLEX CHECK (ASC) .....	34
TONE FREQ. ID SCAN .....	34
FM CTCSS OPERATION .....	35
CTCSS FREQ. ID SCAN .....	35
FM DCS OPERATION .....	36
DCS CODE ID SCAN .....	36

## CHAPTER 9 COMMUNICATING AIDS

RECEIVING .....	37
SELECTING YOUR FREQUENCY .....	37
Direct Frequency Entry .....	37
Using 1 MHz Steps .....	37
Quick QSY .....	37
Fine Tuning .....	38
Equalizing VFO Frequencies (A=B) .....	38
RIT (RECEIVE INCREMENTAL TUNING) .....	38
AGC (AUTOMATIC GAIN CONTROL) .....	38
TRANSMITTING .....	39
VOX (VOICE-OPERATED TRANSMIT) .....	39
Microphone Input Level .....	39
Delay Time .....	39
SPEECH PROCESSOR .....	40
XIT (TRANSMIT INCREMENTAL TUNING) .....	40
CUSTOMIZING TRANSMIT SIGNAL CHARACTERISTICS .....	41
TX Filter Bandwidth (SSB/AM) .....	41
TX Equalizer (SSB/FM/AM) .....	41
TRANSMIT INHIBIT .....	41
CHANGING FREQUENCY WHILE TRANSMITTING .....	41

CW BREAK-IN .....	42
USING SEMI BREAK-IN OR	
FULL BREAK-IN .....	42
ELECTRONIC KEYS .....	42
CHANGING KEYING SPEED .....	42
AUTO WEIGHTING .....	42
Reverse Keying Weight Ratio .....	42
BUG KEY FUNCTION .....	43
CW MESSAGE MEMORY .....	43
Storing CW Messages .....	43
Checking CW Messages without	
Transmitting .....	43
Transmitting CW Messages .....	43
Changing the Inter-message Interval Time .....	44
Changing the Sidetone Volume .....	44
Inset Keying .....	44
FREQUENCY CORRECTION FOR CW .....	44
CW REVERSE (RECEIVE) .....	44
AUTO CW TX IN SSB MODE .....	44

**CHAPTER 10 SUB-RECEIVER**

SUB-RECEIVER .....	45
TX BAND AND CONTROL BAND .....	45
TX BAND .....	45
CONTROL BAND .....	45
RECEIVING .....	45
ACTIVATING THE SUB-RECEIVER .....	45
CONTROLLING THE SUB-RECEIVER .....	45
SELECTING A BAND .....	45
ADJUSTING THE AUDIO FREQUENCY (AF)	
GAIN .....	46
ADJUSTING THE SQUELCH .....	46
SELECTING A FREQUENCY .....	46
SUB-RECEIVER PANEL METER .....	46
SELECTING A MODE FOR	
THE SUB-RECEIVER .....	46
FM CTCSS OPERATION .....	46
FM DCS OPERATION .....	46
TONE FREQ. ID SCAN .....	46
DCS CODE ID SCAN .....	46
ATTENUATOR .....	47
PRE-AMPLIFIER .....	47
DUAL WATCH .....	47
SCAN .....	47
NOISE REDUCTION .....	47
TRANSMITTING .....	47
SELECTING A TRANSMIT POWER .....	47
MICROPHONE GAIN .....	47
FM REPEATER OPERATION .....	47
REVERSE FUNCTION .....	47
AUTOMATIC SIMPLEX CHECK (ASC) .....	48
TRANSMITTING A TONE .....	48
MEMORY .....	48

**CHAPTER 11 SPECIALIZED COMMUNICATIONS**

PACKET RADIO .....	49
BUILT-IN TNC .....	49
PREPARATION .....	50
DCD SENSE .....	50

RADIO TELETYPEWRITING (RTTY) .....	51
PHASE-SHIFT KEYING 31 BAUD (PSK31) .....	52
SLOW SCAN TV/ FACSIMILE .....	52
DX PACKET CLUSTER TUNE .....	52
SATELLITE OPERATION .....	53
BASIC OPERATION .....	53
STORING SATELLITE MEMORY CHANNELS ..	54
RECALLING A SATELLITE MEMORY	
CHANNEL .....	54
SATELLITE CHANNEL NAME .....	54
QUICK MEMORY IN SATELLITE MODE .....	54
CHECKING THE UPLINK FREQUENCY .....	54
USING XIT/ RIT IN SATELLITE MODE .....	54
CHANGING THE FREQUENCY BAND .....	54

**CHAPTER 12 REJECTING INTERFERENCE**

DSP FILTERS .....	55
CHANGING THE RECEIVE FILTER	
BANDWIDTH .....	55
SSB/ FM/ AM Modes .....	55
CW/ FSK Modes .....	55
NOTCH FILTER (SSB) .....	56
BEAT CANCEL (SSB/ AM) .....	56
MANUAL BEAT CANCEL (ALL MODES) .....	56
NOISE REDUCTION .....	56
Setting the N.R. 1 Level Adjustment .....	56
Settign the N.R. 2 Time Constant .....	56
NOISE BLANKER .....	57
PRE-AMPLIFIER .....	57
ATTENUATOR .....	57

**CHAPTER 13 MEMORY FEATURES**

MEMORY CHANNELS .....	58
STORING DATA IN MEMORY .....	58
Simplex Channels .....	58
Split-Frequency Channels .....	59
MEMORY RECALL AND SCROLL .....	59
Memory Recall .....	59
Memory Scroll .....	60
Temporary Frequency Changes .....	60
MEMORY-VFO SPLIT OPERATION .....	60
MEMORY TRANSFER .....	61
Memory ➔ VFO Transfer .....	61
Channel ➔ Channel Transfer .....	61
STORING FREQUENCY RANGES .....	62
Confirming Start/End Frequencies .....	62
Programmable VFO .....	62
Memory Channel Lockout .....	62
ERASING MEMORY CHANNELS .....	62
MEMORY CHANNEL NAME .....	63
MEMORY GROUP .....	64
Memory Group Select .....	64
QUICK MEMORY .....	64
STORING INTO QUICK MEMORY .....	64
RECALLING QUICK MEMORY CHANNELS .....	65
TEMPORARY FREQUENCY CHANGES .....	65
QUICK MEMORY ➔ VFO TRANSFER .....	65

## CONTENTS

### CHAPTER 14 SCAN

NORMAL SCAN .....	66
VFO SCAN .....	66
PROGRAM SCAN .....	67
PROGRAM SCAN PARTIALLY SLOWED .....	67
SCAN HOLD .....	68
MHz SCAN .....	68
MEMORY SCAN .....	68
SCAN RESUME METHOD .....	68
ALL-CHANNEL SCAN .....	68
GROUP SCAN .....	69
CALL SCAN .....	69
VISUAL SCAN .....	70
Using Visual Scan (VFO) .....	70
Changing the Number of Channels to Scan ..	70
Using Visual Scan (Memory Channel) .....	70

### CHAPTER 15 OPERATOR CONVENIENCES

ALT (Auto Lock Tuning) .....	72
ANTENNAS .....	72
HF/ 50 MHz BAND .....	72
VHF/ UHF/ 1.2 GHz BAND .....	72
APO (Auto Power OFF) .....	72
AUTOMATIC ANTENNA TUNER .....	72
Presetting .....	73
ATTENUATOR .....	73
AUTO MODE .....	73
BEEP FUNCTION .....	74
CALL CHANNEL .....	75
DISPLAY .....	75
BRIGHTNESS .....	75
CONTRAST .....	75
KEY ILLUMINATION .....	75
DTMF .....	75
MANUAL DTMF DIALING .....	75
DTMF MEMORY .....	75
Entering DTMF tones .....	75
Transmitting DTMF Memory Channel Data ...	76
DTMF Tone Time Length .....	76
DTMF Pause Period .....	76
HF RX ANTENNA .....	76
LINEAR AMPLIFIER CONTROL .....	76
LOCK FUNCTIONS .....	77
FREQUENCY LOCK FUNCTION .....	77
LOCK ALL FUNCTION .....	77
MICROPHONE PF KEYS .....	77
MONITOR .....	77
PF KEY .....	77
RISE TIME OF CW .....	77
RX DSP EQUALIZER .....	78
EQUALIZING RECEIVING AUDIO (SSB/ FM/ AM) .....	78
SEPARATE SPEAKER OUTPUT .....	78
S-METER SQUELCH .....	78
SQUELCH HANG TIME .....	78
TIME-OUT TIMER .....	78

TNC .....	79
TRANSVERTER .....	79
TX MONITOR .....	79
TX POWER .....	79
QUICK DATA TRANSFER .....	80
SETTING UP .....	80
Equipment Needed .....	80
Connections .....	80
USING QUICK TRANSFER .....	80
Transferring Data .....	80
Receiving Data .....	80
COMPUTER CONTROL .....	81
SETTING UP .....	81
Equipment Needed .....	81
Connections .....	81
COMMUNICATION PARAMETERS .....	81
REMOTE MICROPHONE CONTROLLER .....	81
WIRELESS REMOTE CONTROL (K-type ONLY) ..	82
PREPARATION .....	82
CONTROL OPERATION .....	82
SKY COMMAND II+ (K-type ONLY) .....	83
PREPARATION .....	83
CONTROL OPERATION .....	84
USING TH-D7A AS A COMMANDER .....	85
CONTROL OPERATION .....	85
USING ANOTHER TS-2000 AS A COMMANDER .....	87
USING A SEPARATE TRANSPORTER .....	88
REPEATER FUNCTION (K-type ONLY) .....	88
LOCK-BAND REPEATER .....	88
CROSS-BAND REPEATER .....	88
HANG TIME FOR REPEATER FUNCTION .....	88
DRU-3A DIGITAL RECORDING UNIT (OPTIONAL) .....	89
RECORDING MESSAGES .....	89
MESSAGE PLAYBACK .....	89
Checking Messages .....	89
Sending Messages .....	90
Erasing a Recorded Message .....	90
Changing Inter-message Interval Time .....	90
Changing Playback Volume .....	90
VS-3 VOICE SYNTHESIZER (OPTIONAL) .....	91
MICROPROCESSOR RESET .....	92
INITIAL SETTINGS .....	92
PARTIAL RESET .....	92
FULL RESET .....	92

### CHAPTER 16 CONNECTING PERIPHERAL EQUIPMENT

COMPUTER .....	93
COMPATIBLE TRANSCEIVER .....	93
RTTY EQUIPMENT .....	94
HF LINEAR AMPLIFIER .....	94
ANTENNA TUNER .....	94
MCP AND TNC .....	95
TYPICAL MCP/ TNC SETUP .....	96
LINEAR AMPLIFIER (50 MHz, 144 MHz, 430 (440) MHz and 1.2 GHz) .....	96



<b>CHAPTER 17</b>	<b>INSTALLING OPTIONS</b>	
	REMOVING THE BOTTOM CASE .....	97
	DRU-3A DIGITAL RECORDING UNIT .....	97
	VS-3 VOICE SYNTHESIZER UNIT .....	97
	MB-430 MOBILE BRACKET .....	98
	RC-2000 REMOTE PANEL .....	98
<b>CHAPTER 18</b>	<b>TROUBLESHOOTING</b>	
	GENERAL INFORMATION .....	99
	SERVICE .....	99
	SERVICE NOTE .....	99
	CLEANING .....	99
	LITHIUM BATTERY .....	99
	DEMONSTRATION MODE .....	99
	TROUBLESHOOTING .....	100
	OPERATION NOTICES .....	103
	DC POWER SUPPLY .....	103
	TX SIGNAL HARMONICS .....	103
	INTERNAL BEATS .....	103
	VISUAL SCAN .....	103
	SENSITIVITY (K-type ONLY) .....	103
	AGC .....	103
	SUB-RECEIVER.....	103
<b>CHAPTER 19</b>	<b>OPTIONAL ACCESSORIES</b>	
	OPTIONAL ACCESSORIES .....	104
<b>CHAPTER 20</b>	<b>SPECIFICATIONS</b>	
	SPECIFICATIONS .....	105
<b>CHAPTER 21</b>	<b>APPENDIX</b>	
	TS-B2000 FRONT PANEL .....	109
	BUILT-IN TNC COMMAND LIST .....	110
	COM CONNECTOR .....	113
	HARDWARE DESCRIPTION .....	113
	CONTROL OPERATION .....	113
	COMPUTER CONTROL .....	114
	Alphabetical Commands .....	114
	Parameters .....	114
	Terminator .....	114
	Error Messages .....	114
	PC CONTROL COMMAND TABLES .....	115
<b>CHAPTER 22</b>	<b>INDEX</b>	
	INDEX .....	142



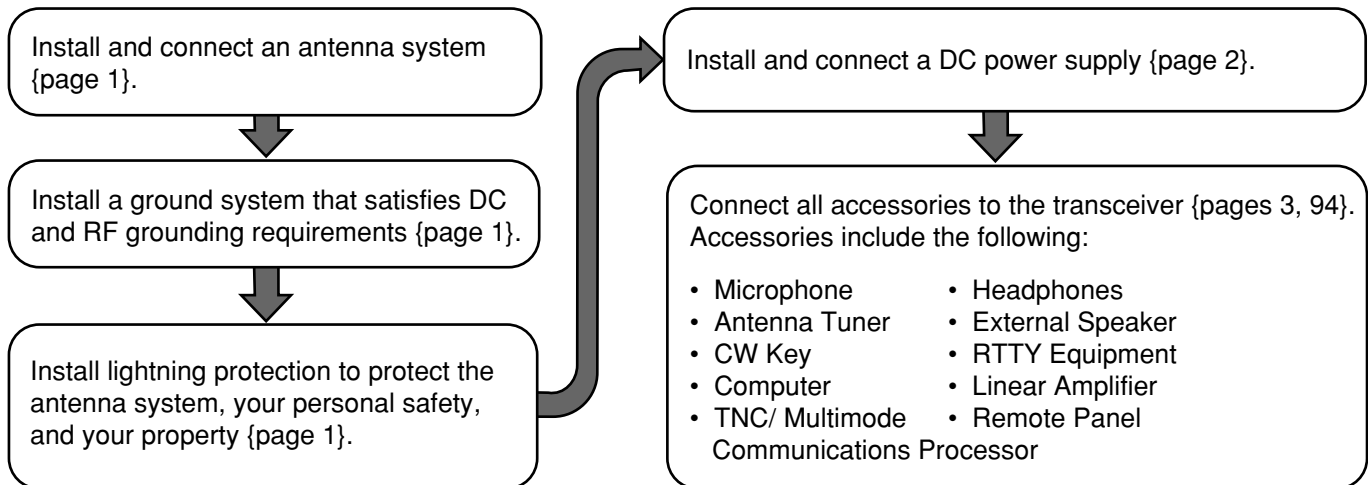

## ANTENNA CONNECTION

An antenna system consists of an antenna, feed line, and ground. The transceiver can give excellent results if the antenna system and its installation are given careful attention. Use a properly adjusted 50Ω antenna of good quality, a high-quality 50Ω coaxial cable, and first-quality connectors. All connections must be clean and tight.

After making the connections, match the impedance of the coaxial cable and antenna so that the SWR is 1.5:1 or less. High SWR will cause the transmit output to drop and may lead to radio frequency interference to consumer products such as stereo receivers and televisions. You may even interfere with your own transceiver. Reports that your signal is distorted could indicate that your antenna system is not efficiently radiating the transceiver's power.

Connect your primary HF/ 50 MHz antenna feed line to ANT□1 on the rear of the transceiver. If you are using two HF/ 50 MHz antennas, connect the secondary antenna to ANT□2. Connect VHF (144 MHz), UHF (430/ 440 MHz), and 1.2 GHz (TS-2000/ TS-B2000 Optional) antennas to their respective antenna connectors on the rear of the transceiver. Refer to page 13 for the location of the antenna connectors.

**CAUTION**

- ◆ *Transmitting without connecting an antenna or other matched load may damage the transceiver. Always connect the antenna to the transceiver before transmitting.*
- ◆ *All fixed stations should be equipped with a lightning arrester to reduce the risk of fire, electric shock, and transceiver damage.*

**Note:** *The transceiver's protection circuit will activate when the SWR is greater than 2.5:1; however, do not rely on protection to compensate for a poorly functioning antenna system.*

## GROUND CONNECTION

At the minimum, a good DC ground is required to prevent such dangers as electric shock. For superior communications results, a good RF ground is required, against which the antenna system can operate. Both of these conditions can be met by providing a good earth ground for your station. Bury one or more ground rods or a large copper plate under the ground, then connect this to the transceiver GND terminal. Use heavy gauge wire or a copper strap, cut as short as possible, for this connection. Do not use a gas pipe, an electrical conduit, or a plastic water pipe as a ground.

## LIGHTNING PROTECTION

Even in areas where lightning storms are less common, there are usually a limited number of storms each year. Consider carefully how to protect your equipment and home from lightning. The installation of a lightning arrester is a start, but there is more that you can do. For example, terminate your antenna system transmission lines at an entry panel that you install outside your home. Ground this entry panel to a good outside ground, then connect the appropriate feed lines between the entry panel and your transceiver. When a lightning storm occurs, disconnecting the feed lines from your transceiver will ensure added protection.

# 1 INSTALLATION

## DC POWER SUPPLY CONNECTION

In order to use this transceiver, you need a separate 13.8 V DC power supply that must be purchased separately. Do not directly connect the transceiver to an AC outlet. Use the supplied DC power cable to connect the transceiver to a regulated power supply. Do not substitute a cable with smaller gauge wires. The current capacity of the power supply must be 20.5 A peak or more.

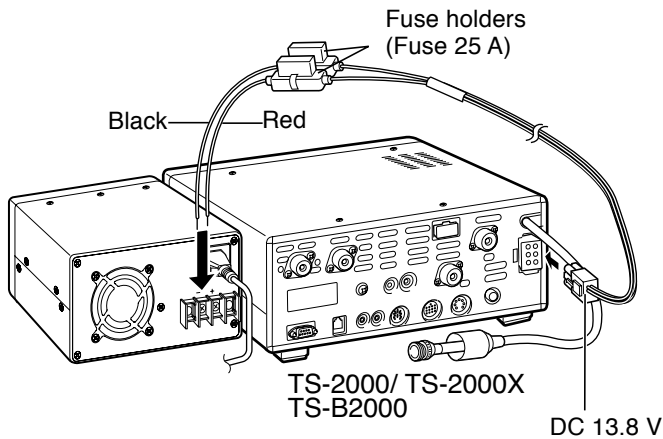

First, connect the DC power cable to the regulated DC power supply; the red lead to the positive terminal and the black lead to the negative terminal. Next, connect the DC power cable to the transceiver's DC power connector. Press the connectors firmly together until the locking tab clicks.

**Note:**

- ◆ Before connecting the DC power supply to the transceiver, be sure to switch OFF the DC power supply and transceiver.
- ◆ Do not plug the DC power supply into an AC outlet until you make all connections.

### PROTECTIVE COVERS

Remove the protective covers from the jacks and connectors on the transceiver before making connections.

### NOISE FILTER (E and E2-type only)

Install the supplied noise filter on the DC power cable to comply with the European EMC standard.

#### Installation

- 1 Open the filter by releasing the locking tab. Position the transceiver DC power cable in the groove of one filter half.

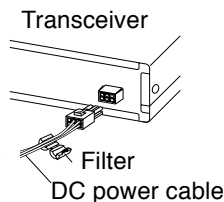

- 2 Close the filter and squeeze the filter halves together until the locking tab locks. Pass the cable tie end through the hole on the end of the filter.

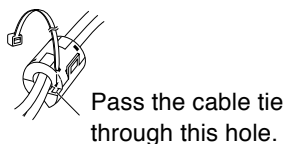

- 3 Wrap the cable tie around the DC power cable, then insert the cable tie end into the cable tie clasp. Pull the cable tie end through the clasp as far as possible.

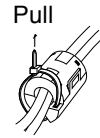

- 4 Cut off the excess portion of the cable tie protruding through the clasp.

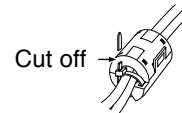

## UTILIZING THE BAIL (TS-2000(X) ONLY)

This transceiver is equipped with a bail so that you can angle the transceiver. The bail is located on the bottom of the transceiver. Pull the bail forward to the limit as shown.

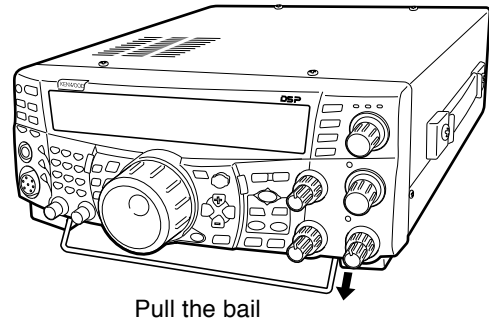

## REPLACING FUSES

If a fuse blows, determine the cause then correct the problem. Only after the problem has been resolved, replace the blown fuse with a new one with the specified ratings. If newly installed fuses continue to blow, disconnect the power plug and contact a **KENWOOD** service station or your dealer for assistance.

Fuse Location	Fuse Current Rating
TS-2000(X)/ TS-B2000	4 A (For an external antenna tuner)
Supplied DC power cable	25 A

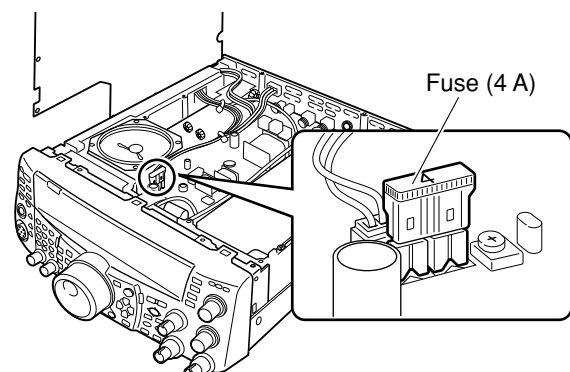

## ACCESSORY CONNECTIONS

### FRONT PANEL

#### ■ Headphones (PHONES)

Connect monaural or stereo headphones having a 4 to 32 $\Omega$  impedance. This jack accepts a 6.3 mm (1/4") diameter, 2-conductor (mono) or 3-conductor (stereo) plug. After connecting the headphones, you will hear no sound from the internal (or optional external) speaker.

#### ■ Microphone (MIC)

Connect a microphone having an impedance between 250 and 600 $\Omega$ . Fully insert the connector, then screw the retaining ring clockwise until secure. Compatible microphones include the MC-43S, MC-47, MC-52DM, MC-60A, MC-80, MC-85, and MC-90. Do not use the MC-44, MC-44DM, MC-45, MC-45E, MC-45DM, MC-45DME, or MC-53DM microphones.

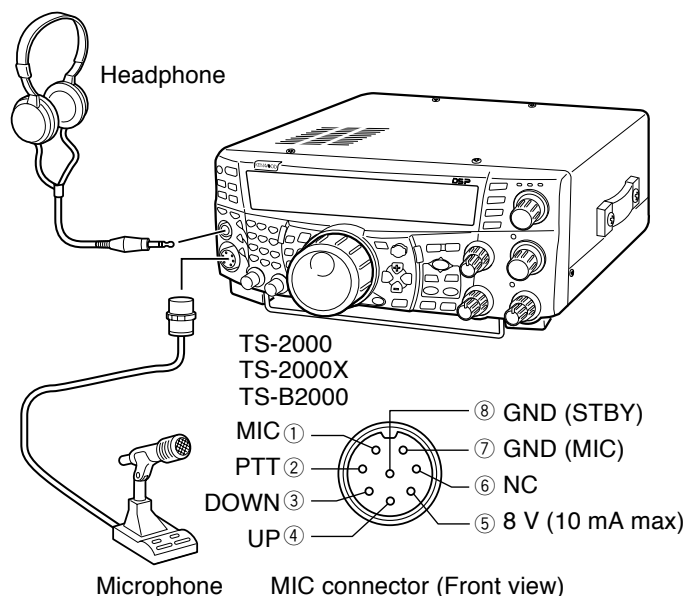

### REAR PANEL

#### ■ External Speakers (EXT.SP1/ EXT.SP2)

This transceiver has 2 independent receivers. Thus, it can output 2 separate audio signals. As a default, the transceiver mixes both audio signals internally and outputs them from the internal speaker. On the rear panel of the transceiver, there are 2 external speaker jacks. If an external speaker is connected to EXP.SP1, the internal speaker will mute. If the speaker is connected to EXT.SP2, both the external speaker and the internal speaker will function. Use only external speakers with an impedance of 4 to 8 $\Omega$  (8 $\Omega$  nominal). These jacks accept only 3.5 mm (1/8") diameter, 2-conductor (mono) plugs.

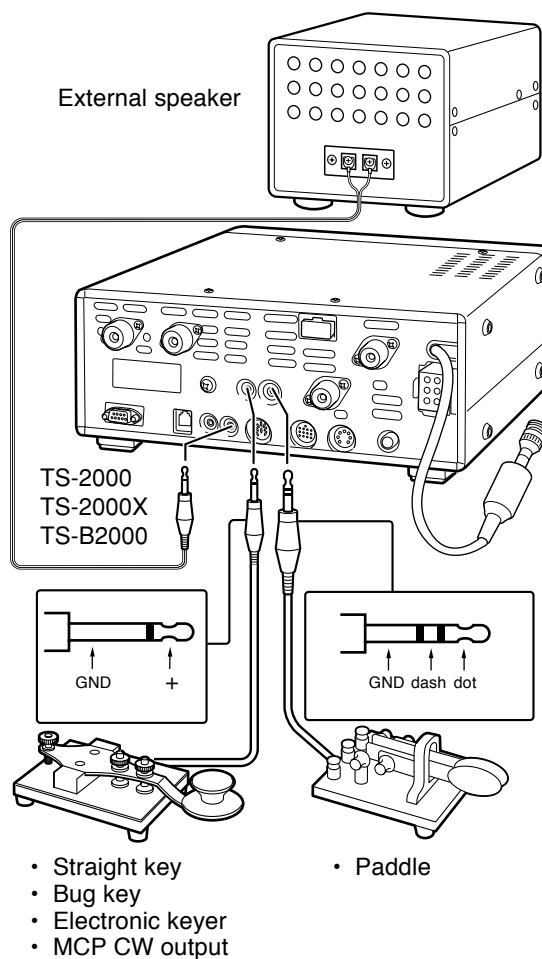

#### ! WARNING

Do not connect headphones to this jack. The high audio output of this jack could damage your hearing.

#### ■ Keys for CW (PADDLE and KEY)

For CW operation using the internal electronic keyer, connect a keyer paddle to the PADDLE jack. For CW operation without using the internal electronic keyer, connect a straight key, semi-automatic key (bug), electronic keyer, or the CW keyed output from a Multimode Communications Processor (MCP) to the KEY jack. The PADDLE and KEY jacks mate with a 6.3 mm (1/4") 3-conductor plug and a 3.5 mm (1/8") 2-conductor plug respectively. External electronic keyers or MCPs must use positive keying to be compatible with this transceiver. Use a shielded cable between the key and the transceiver.

**Note:** Due to the functionality of the internal electronic keyer, you may find it unnecessary to connect both a paddle and another type of keyer unless you want to use a PC-based keyer for CW. Read the "ELECTRONIC KEYER" section (page 42) to become familiar with the internal keyer.

# YOUR FIRST QSO (HF/ 50 MHz band)

Are you ready to give your TS-2000(X) a quick try? Reading these two pages should get your voice on the air in your first QSO on the HF/ 50 MHz band shortly. The instructions below are intended only for a quick guide. If you encounter problems or there is something you don't understand, read the detailed explanations given later in this manual.

## RECEIVING

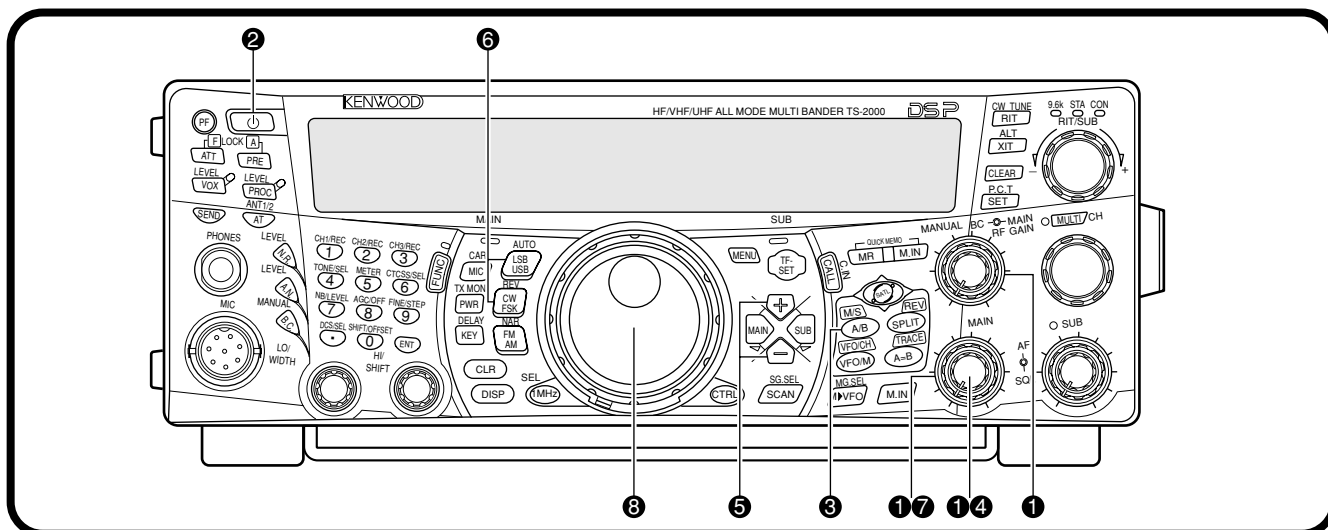

**Note:** This section explains only keys and controls required to briefly try the transceiver.

① Set the following as specified:

- **MAIN AF:** Fully counterclockwise
- **MAIN RF GAIN:** Fully clockwise
- **MAIN SQL:** Fully counterclockwise

② Switch ON the DC power supply, then press and hold [  $\phi$  ] (POWER) briefly on the transceiver.

- Do not press the switch for more than approximately 2 seconds; the transceiver will be switched OFF.
- Upon power up, "HELLO" appears, followed by the selected frequency and other indicators.

HELLO

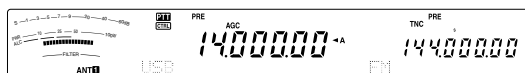

③ Confirm that VFO A has been selected for communications; "◀A" should be visible on the display. If it has not, press [A/B] to select VFO A.

④ Turn the **MAIN AF** control slowly clockwise until you hear a suitable level of background noise.

⑤ Press [+]/ [-] to select an HF/ 50 MHz Amateur radio band.

⑥ Press [LSB/ USB/ AUTO] or [FM/ AM/ NAR] to select an operating mode.

- To select the second mode on each key, press the same key again. For example, each press of [LSB/ USB/ AUTO] switches between LSB and USB modes.

⑦ If you have selected FM, turn the **MAIN SQL** control clockwise until the background noise is just eliminated; the **MAIN** band LED (above the [MIC/ CAR] key) turns off.

- With LSB or USB selected, skip this step.

⑧ Turn the **Tuning** control to tune in a station.

- If you do not hear any stations, you may have the wrong antenna connector selected. Press [FUNC], [AT/ ANT1/2] to switch between the antenna 1 and 2 connectors.

TRANSMITTING

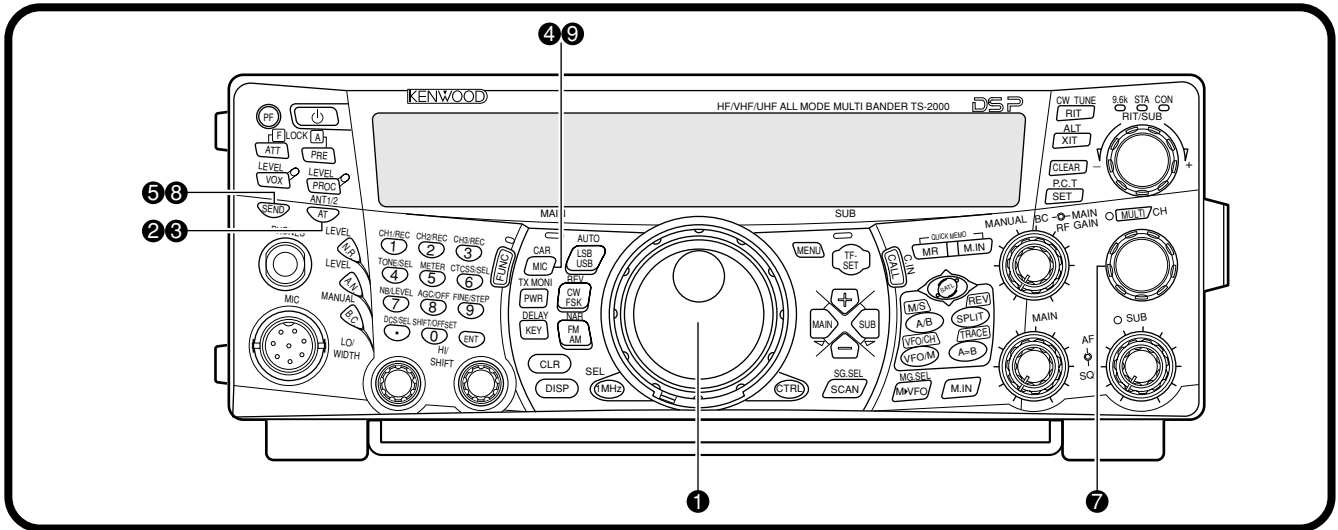

- 1 Turn the **Tuning** control to tune in a desired station or to select an unused frequency.
- 2 Press [**AT/ ANT1/2**] momentarily.
  - “AT **TX**” appears.

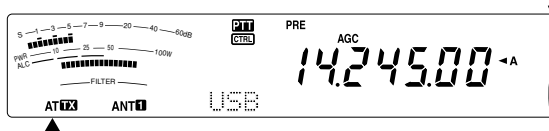

- 3 Press and hold [**AT/ ANT1/2**] to activate the built-in antenna tuner.
  - “AT **TX**” starts blinking and the **MAIN** band LED above the [**MIC/ CAR**] key turns red.



- Tuning should be completed in under 20 seconds, then “AT **TX**” stops blinking.
- If tuning is not completed within 20 seconds, error beeps sound. Press [**AT/ ANT1/2**] to stop the error beeps and quit tuning. Check your antenna system before continuing. If you do not press [**AT/ ANT1/2**], tuning will continue for approximately 60 seconds.

**Note:** You will hear a lot of clicking sounds coming from the transceiver while the antenna tuner is trying to tune the antenna. This is simply the relay switches turning ON and OFF.

- 4 With LSB, USB, or AM selected, press [**MIC/ CAR**] to activate the Microphone Gain Adjust.
  - “MIC GAIN 50” appears.



- With FM selected, skip this step.
- 5 Press [**SEND**].
  - The **MAIN** band LED turns red.
- 6 Begin speaking into the microphone in your normal tone of voice.
- 7 **LSB/ USB:** While speaking into the microphone, adjust the **MULTI/ CH** control so that the ALC meter reflects according to your voice level.

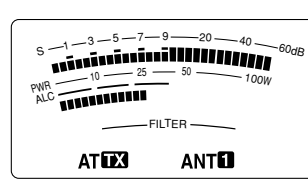

**AM:** While speaking into the microphone, adjust the **MULTI/ CH** control so that the calibrated power meter slightly reflects to your voice level.

**FM:** Skip this step.

- 8 When you finish speaking, press [**SEND**] to return to receive mode.
- 9 Press [**MIC/ CAR**] to quit the Microphone Gain Adjust.

**Note:** If desired, access Menu No. 41 {page 28} to try the Microphone Gain Adjust for FM.

This completes your introduction to the TS-2000(X), but there is a great deal more to know. “OPERATING BASICS” {page 18} and the following chapters explain all the functions of this transceiver, starting with the most basic, commonly-used functions.

# YOUR FIRST QSO (VHF/ UHF band)

If your primary operating band is VHF (144 MHz) or UHF (430/ 440 MHz), the TS-2000(X) can also serve you as a powerful All-mode VHF/ UHF transceiver. The instructions below are intended only for a quick guide to get you up on the air on the VHF/ UHF band. If you encounter problems or there is something you don't understand, read the detailed explanations given later in this manual.

## RECEIVING

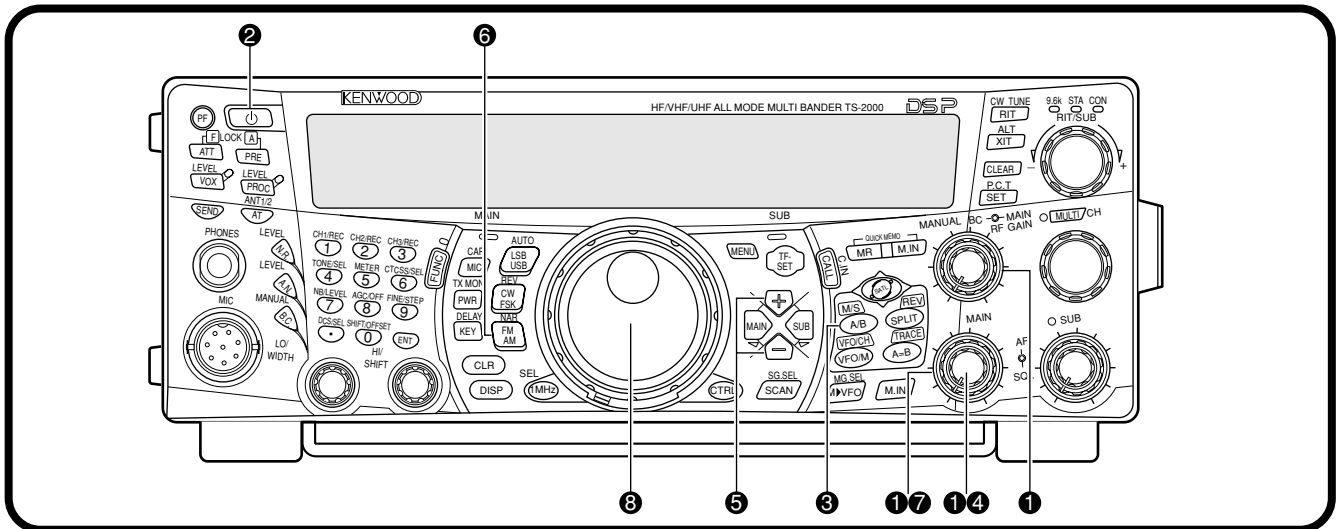

**Note:** This section explains only keys and controls required to briefly try the transceiver.

- 1 Set the following as specified:
  - **MAIN AF:** Fully counterclockwise
  - **MAIN RF GAIN:** Fully clockwise
  - **MAIN SQL:** Fully counterclockwise
- 2 Switch ON the DC power supply, then press and hold [  $\phi$  ] (POWER) briefly on the transceiver.
  - Do not press the switch for more than approximately 2 seconds; the transceiver will be switched OFF.
  - Upon power up, "HELLO" appears, followed by the selected frequency and other indicators.



- 3 Press [MAIN], then confirm that VFO A has been selected for communications; "◀A" should be visible on the display. If it has not, press [A/B] to select VFO A.
- 4 Turn the **MAIN AF** control slowly clockwise until you hear a suitable level of background noise.
- 5 Press [ + ] / [ - ] to move up to the VHF (144 MHz) or UHF (430/ 440 MHz) Amateur radio band.

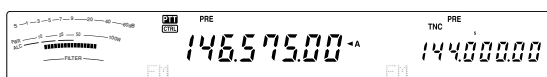

- 6 Confirm that the operating mode is FM. If it is not, press [FM/ AM/ NAR] to select FM.
- 7 Turn the **SQL** control clockwise until the background noise is just eliminated; the **MAIN** band LED turns off.
- 8 Turn the **Tuning** control to tune in a station.
  - You can use the **MULTI/ CH** control to change the frequency faster. If you do not hear any stations, the antenna may not be installed or connected properly. Check the antenna connector on the rear panel {page 13}.



## TRANSMITTING

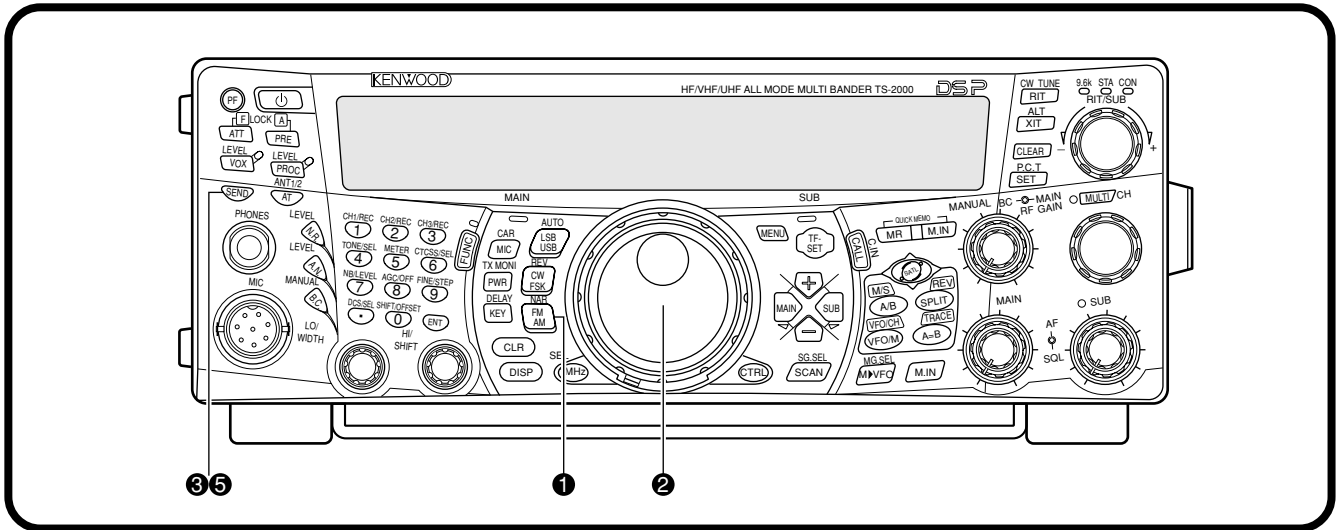

- ❶ Confirm that the operating mode is FM. If it is not, press **[FM/ AM/ NAR]** to change the operating mode to FM.
- ❷ Turn the **Tuning** control or the **MULTI/ CH** control to tune in a desired station or to select an unused frequency.
- ❸ Press **[SEND]**.
  - The **MAIN** band LED turns red.
- ❹ Begin speaking into the microphone in your normal tone of voice.

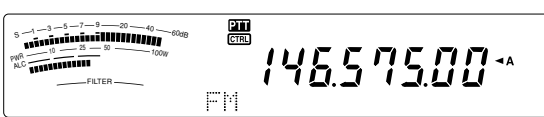

- ❺ When you finish speaking, press **[SEND]** to return to receive mode.

This completes your introduction on how to receive and transmit using the TS-2000(X) on a VHF/ UHF band. Refer to "OPERATING BASICS" {page 18} and the following chapters for explanations on all the functions of this transceiver.

# GETTING ACQUAINTED

## FRONT PANEL

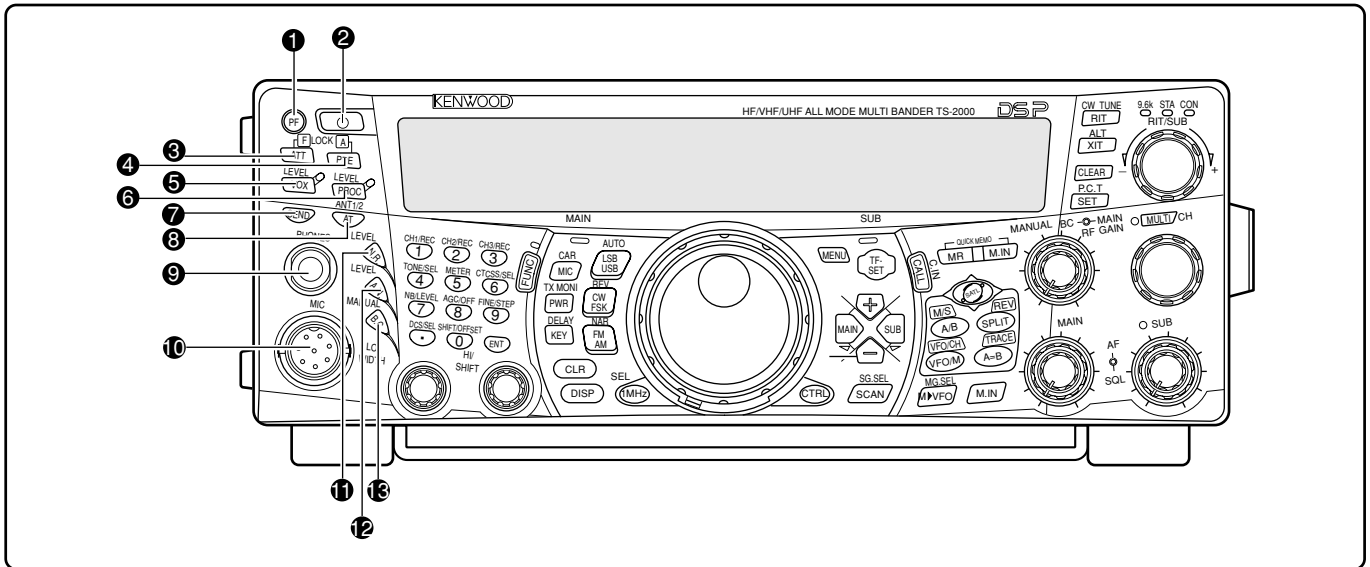

### 1 PF key

You can assign a function to this Programmable Function key. The default function is Voice 1 {page 77}.

### 2 [ ⏻ ] (POWER) switch

Press and hold briefly to switch the transceiver power ON. Press again to switch the power OFF.

### 3 ATT/ F LOCK key

Press to switch the receiver attenuator ON or OFF {page 57}. Press **[FUNC]**, **[ATT/ F LOCK]** to switch the Frequency Lock function ON or OFF {page 77}.

### 4 PRE/ LOCK A key

Press to switch the receiver pre-amplifier ON or OFF {page 57}. Press **[FUNC]**, **[PRE/ LOCK A]** to lock all the transceiver keys {page 77}.

### 5 VOX/ LEVEL key

In voice mode, press to switch the Voice-Operated Transmit function ON or OFF {page 39}. In CW mode, press to switch the Break-in function ON or OFF {page 42}. Press **[FUNC]**, **[VOX/ LEVEL]** to adjust the microphone input level for VOX operation. The **VOX** LED lights orange when the VOX function is active.

### 6 PROC/ LEVEL key

Press to switch the Speech Processor for transmitting ON or OFF {page 40}. Press **[FUNC]**, **[PROC/ LEVEL]** to adjust the Speech Processor input level. The **PROC** LED lights orange when the Speech Processor function is activated.

### 7 SEND key

Press to switch the transceiver between receive mode and transmit mode {pages 5, 7}.

### 8 AT/ ANT1/2 key

Press to activate the internal antenna tuner {page 72} or an external antenna tuner. Press **[FUNC]**, **[AT/ ANT1/2]** to select either Antenna 1 or Antenna 2 for the HF/ 50 MHz band {page 72}.

### 9 PHONES jack

Connect a set of headphones to this jack. Inserting a plug into the jack automatically mutes the audio from the speaker {pages 3, 78}.

### 10 MIC connector

Connect a compatible microphone to this connector, then securely screw down the connector locking ring {page 3}.

### 11 N.R./ LEVEL key

Press to switch the DSP Noise Reduction function ON or OFF. Press **[FUNC]**, **[N.R./ LEVEL]** to adjust the Noise Reduction level. Press **[FUNC]**, **[N.R./ LEVEL]** again to finish the adjustment {page 56}.

### 12 A.N./ LEVEL key

Press to switch the DSP Auto Notch function ON or OFF. Press **[FUNC]**, **[A.N./ LEVEL]** to adjust the DSP Auto Notch reduction level. Press **[FUNC]**, **[A.N./ LEVEL]** again to finish the adjustment {page 56}.

### 13 B.C./ MANUAL key

Press to switch the DSP Auto Beat Cancel function ON or OFF. Press **[FUNC]**, **[B.C./ MANUAL]** to adjust the beat cancel frequency manually. Press **[FUNC]**, **[B.C./ MANUAL]** again to finish the manual adjustment {page 56}.

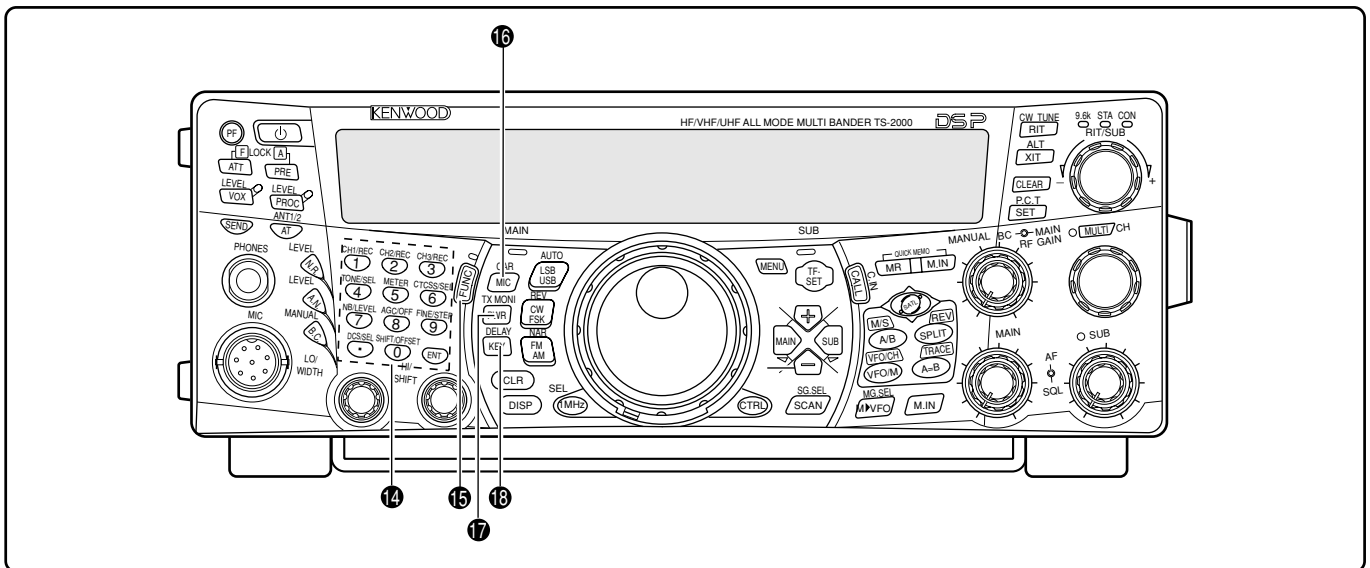

#### 14 Multi-purpose keypad

Consists of 10 keys that are used to enter numeric data. Also used for the following functions:

- **1/ CH1/REC, 2/ CH2/REC, and 3/ CH3/REC** keys  
Press to play back or record the CW or voice messages that are associated with the DRU-3A Digital Recording Unit {page 89} and the internal electronic keyer {page 43}.
- **4/ TONE/SEL** key  
Press to activate the sub-audible Tone function to access repeaters for FM mode. To select the Tone frequency, press **[FUNC]**, **[4/ TONE/SEL]**, then select your desired tone frequency using the **MULTI/ CH** control {page 33}.
- **5/ METER** key  
Press to select the meter scales {page 19}.
- **6/ CTCSS/SEL** key  
Press to activate the Continuous Tone Coded Squelch System (CTCSS) function for FM mode. To select the CTCSS tone frequency, press **[FUNC]**, **[5/ CTCSS/SEL]**, then select your desired CTCSS tone frequency using the **MULTI/ CH** control {page 35}.
- **7/ NB/LEVEL** key  
Press to switch the Noise Blanker ON or OFF. Press **[FUNC]**, **[7/ NB/LEVEL]** to adjust the Noise Blanker level {page 57}.
- **8/ AGC/OFF** key  
Press to adjust the response time of the Automatic Gain Control. To switch the AGC OFF, press **[FUNC]**, **[8/ AGC/OFF]** {page 38}.
- **9/ FINE/STEP** key  
Press to activate the Fine tuning function to allow more precise tuning {page 38}.

- **•/ DCS/SEL** key

Press to activate the Digital Coded Squelch function for FM mode. To select the DCS code, press **[FUNC]**, **[•/ DCS/SEL]**, then select your desired code using the **MULTI/ CH** control {page 36}.

- **0/ SHIFT/OFFSET** key

Press to switch the Shift function for FM mode ON or OFF when accessing the repeaters. The Shift frequency can be manually adjusted by pressing **[FUNC]**, **[0/ SHIFT/OFFSET]**, then adjusting the shift frequency value using the **MULTI/ CH** control {page 32}.

- **ENT** key

Press to enter your desired frequency using the keypad {page 37}.

#### 15 FUNC key

Press to access the secondary functions that are assigned to the keys. While FUNC is active, the **FUNC** LED lights orange.

#### 16 MIC/ CAR key

Press to adjust the microphone gain {page 20}. While the Speech Processor function is ON, it becomes the Speech Processor output level adjustment key {page 40}.

Press **[FUNC]**, **[MIC/ CAR]** to adjust the carrier level for CW, FSK and AM mode {page 20}.

#### 17 PWR/ TX MONI key

Press to adjust the output power {page 20}. Press **[FUNC]**, **[PWR/ TX MONI]** to monitor your transmission signal {page 79}.

#### 18 KEY/ DELAY key

Press to adjust the internal electronic keyer speed. Press **[FUNC]**, **[KEY/ DELAY]** to adjust the VOX delay time or break-in time (Full break-in/ Semi break-in time) for CW mode {page 42}.

## 4 GETTING ACQUAINTED

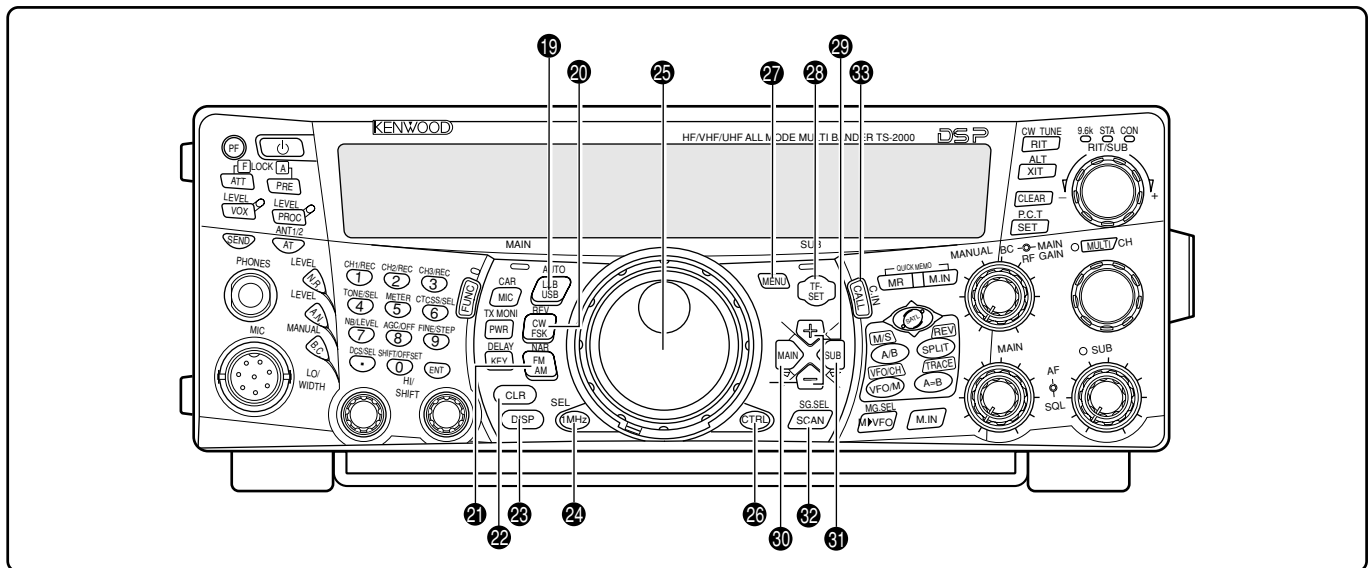

### 19 LSB/ USB/ AUTO key

Press to select lower sideband (LSB) or upper sideband (USB) mode for voice or digital operation. Press **[FUNC]**, **[LSB/ USB/ AUTO]** to toggle the auto mode selection {page 73}.

### 20 CW/ FSK/ REV key

Press to select CW or FSK (Frequency Shift Keying) mode {pages 30, 51}. Press **[FUNC]**, **[CW/ FSK/ REV]** to reverse the sideband pitch.

### 21 FM/ AM/ NAR key

Press to select FM or AM mode {pages 28, 29}. Press **[FUNC]**, **[FM/ AM/ NAR]** to select narrow bandwidth transmission mode {page 29}.

### 22 CLR key

Press to exit from, abort, or reset various functions. Also used to erase memory channels {page 62} or locking out memory channels from the scan list {page 62}.

### 23 DISP key

Press to toggle the normal operating mode and DSP filter setting display mode {page 55}. Press and hold to start the Visual Scan function {page 70}.

### 24 1MHz/ SEL key

Press to switch the MHz Up/ Down function ON or OFF using the **MULTI/ CH** control. Press **[FUNC]**, **[1MHz/ SEL]** to change the increment/ decrement step value {page 37}. Press and hold to start the MHz Scan function {page 68}.

### 25 Tuning control

Turn to select the desired frequency {page 37}. Use the convenient finger-tip cavity for continuous tuning.

The lever behind this control adjusts the control torque level; turn fully clockwise for light torque or fully counterclockwise for heavy torque.

### 26 CTRL key

Press to toggle the operating controls between the main transceiver and the sub-receiver. The transmission band is not affected by this key.

### 27 MENU key

Press to select or cancel the Menu mode that is used for activating and configuring functions {page 21}.

### 28 TF-SET key

While operating split-frequency, press to monitor or change your transmit frequency {page 31}.

### 29 +/- (Up/ Down) keys

Press to step through all the Amateur radio bands consecutively {page 18}. Also used to make selections from the Menu {page 21}, and to check the Start and End frequencies of the Scan function {page 62}.

### 30 MAIN key

Press to transfer the operating controls to the MAIN transceiver. Also moves the transmission band to the main transceiver frequency.

### 31 SUB key

Press to transfer the operating controls to the sub-receiver. Also moves the transmission band to the sub-receiver frequency.

### 32 SCAN/ SG.SEL key

Press to start or stop the Scan function {page 66}. Press **[FUNC]**, **[SCAN/ SG.SEL]** to select a scan group {page 69}.

### 33 CALL/ C.IN key

Press to recall a call channel for the selected operating band (HF/ 50 MHz/ 144 MHz/ 430 (440) MHz/ 1.2 GHz (TS-2000/ TS-B2000 Optional)). Press **[FUNC]**, **[CALL/ C.IN]** to write a new Call Channel to the memory {page 75}.

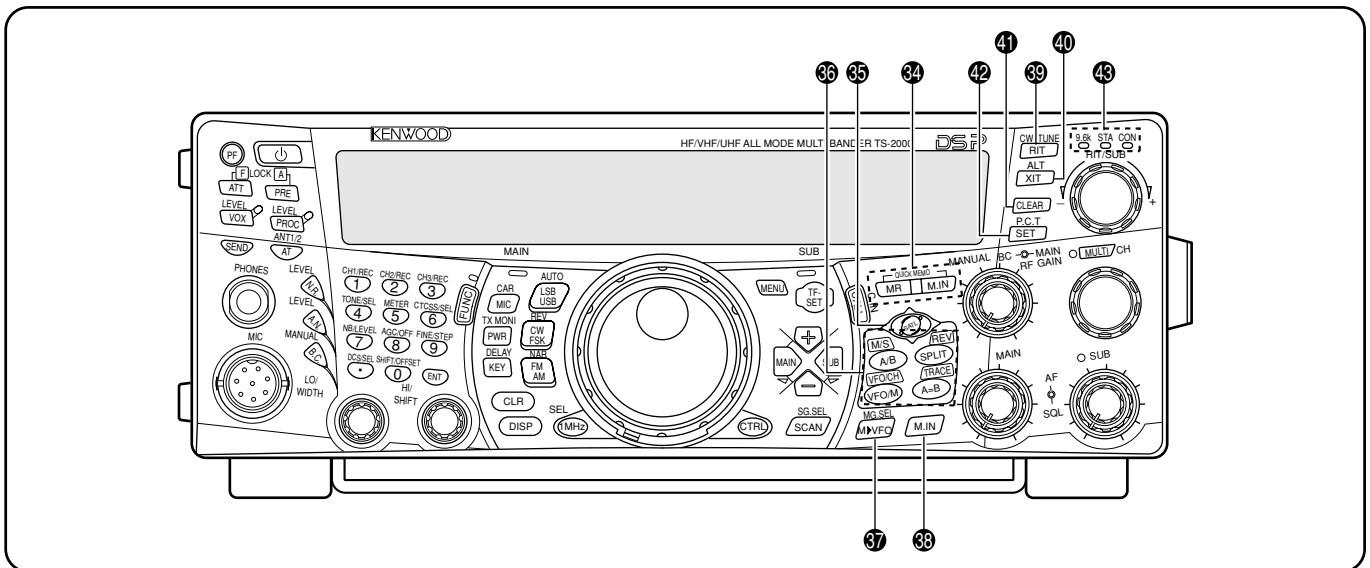

### 34 QUICK MEMO keys

Controls the Quick Memory function {page 64}.

- **MR** key  
Press to recall data from the Quick Memory {page 65}.
- **M.IN** key  
Press to write data into the Quick Memory {page 64}.

### 35 SATL key

Press to activate Satellite communication mode {page 53}.

### 36 Frequency control keys

These keys control functions related to selecting a frequency, a VFO, or a memory channel.

- **A/B / M/S** key  
Press to select either VFO A or VFO B {page 18}. In Satellite mode, press to swap the MAIN and SUB frequencies so that you can change the frequencies with a **Tuning** control {page 54}.
- **SPLIT/ REV** key  
Press to use split-frequency operation which allows you to use different transmit and receive frequencies {page 31}. In Satellite mode, press to toggle the Trace Reverse function ON and OFF {page 54}.
- **VFO/M / VFO/CH** key  
Press to select either Memory or VFO mode {page 59}. In Satellite mode, press to toggle the VFO and memory channel operations {page 54}.
- **A=B/ TRACE** key  
Press to copy the data in the currently selected VFO to the other VFO {page 31}. In Satellite mode, press to toggle the TRACE function ON and OFF {page 54}.

### 37 M VFO/ MG.SEL key

Press to transfer data from a memory channel to a VFO {page 61}. Press **[FUNC]**, **[M VFO/ MG.SEL]** to enter Memory Group Select mode {page 64}.

### 38 M.IN key

Writes data into a memory channel {page 58} or selects Memory Scroll mode {page 60}.

### 39 RIT/ CW TUNE key

Press to switch the Receive Incremental Tuning function ON or OFF {page 38}. Press **[FUNC]**, **[RIT/ CW TUNE]** to activate the automatic zero-beat function for CW mode {page 30}.

### 40 XIT/ ALT key

Press to switch the Transmit Incremental Tuning function ON or OFF {page 40}. Press **[FUNC]**, **[XIT/ ALT]** to switch the Auto Lock Tuning mode for the 1.2 GHz band (FM) ON or OFF {page 72}.

### 41 CLEAR key

Press to reset the RIT/XIT frequency offset to zero {pages 38, 40}.

### 42 SET/ P.C.T. key

Press to set received DX Packet Cluster frequency data to the main transceiver when the Packet Cluster Tune mode is activated. Press **[FUNC]**, **[SET/ P.C.T.]** to switch the Packet Cluster Tune mode ON or OFF {page 53}.

### 43 TNC Status Indicators

- **9.6k LED**  
Lights when the internal TNC is operating at 9600 bps. The default operating mode is 1200 bps {page 50}.
- **STA LED**  
Lights when the internal TNC holds the data in the buffer to transmit.
- **CON LED**  
Lights when the internal TNC is connected to another TNC.

## 4 GETTING ACQUAINTED

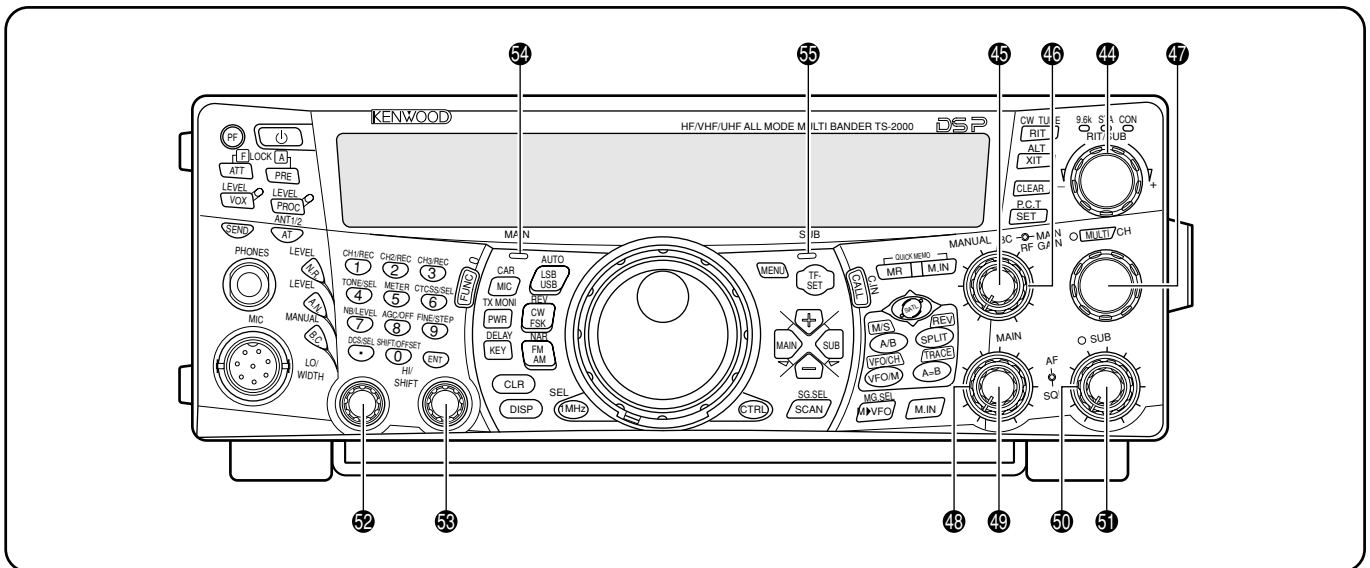

### 44 RIT/SUB control

After switching the RIT or XIT function ON, turn this control to select the desired frequency offset {pages 38, 40}.

Turn to adjust the sub-receiver frequency when the RIT and XIT functions are switched OFF and the sub-receiver is switched ON {page 45}.

### 45 MANUAL BC control

Turn to adjust the audio notch frequency while the DSP beat cancel function is set to the manual frequency adjustment mode {page 56}.

### 46 MAIN RF GAIN control

Turn to adjust the radio frequency gain for the main transceiver {page 18}.

### 47 MULTI/ CH control

In VFO mode, rotate to step the operating frequency up or down {page 37}. In memory channel mode, rotate to select a memory channel {page 58}. Also used for selecting Menu numbers when accessing the Menu mode {page 21} and as a selector to choose settings for various functions activated by front panel buttons. The **MULTI/ CH** LED lights when the setting(s) can be changed using the **MULTI/ CH** control.

### 48 MAIN SQL control

Used for muting (“squelching”) the speaker, the head phones and AF output on ACC2 (13-pin DIN connector) when no receive signal is present on the main transceiver {page 19}.

### 49 MAIN AF control

Turn to adjust the volume on the main transceiver {page 19}.

### 50 SUB SQL control

Used for muting (“squelching”) the speaker, head phone and AF output on ACC2 (13-pin DIN connector) when no receive signal is present on the sub-receiver {page 46}.

### 51 SUB AF control

Press to switch the sub-receiver ON or OFF. When it is ON, the SUB-receiver LED lights orange.

Turn to adjust the volume for the sub-receiver.

### 52 LO/ WIDTH control

Turn clockwise/ counterclockwise to increase/ decrease the value for the low cut-off DSP filter frequency or the filter bandwidth (CW/ FSK). The selected value appears on the main dot-matrix display {page 55}.

### 53 HI/ SHIFT control

Turn clockwise/ counterclockwise to increase/ decrease the value for the high cut-off DSP filter frequency or the Shift frequency. The selected value appears on the sub dot-matrix display {page 55}.

### 54 MAIN band LED

Lights green while the main transceiver’s squelch is open. Lights red while transmitting on the main transceiver’s VFO band.

### 55 SUB band LED

Lights green while the sub-receiver’s squelch is open. Lights red while transmitting on the sub-receiver’s VFO band.

## REAR PANEL

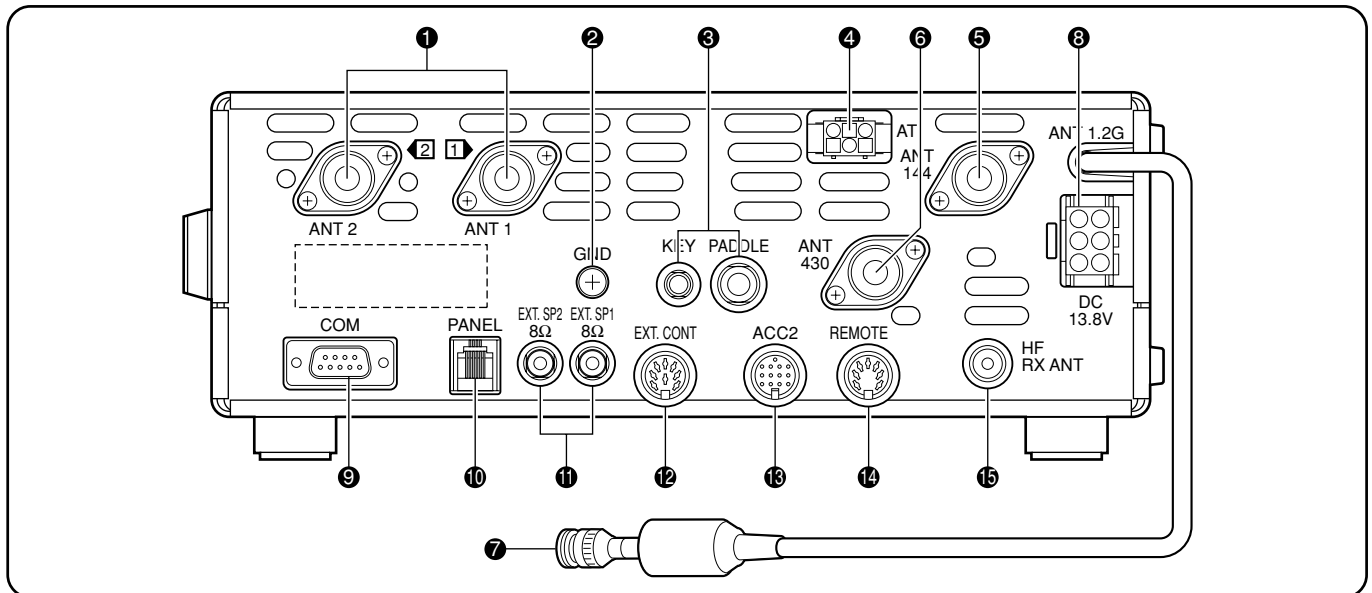
**1 ANT 1 and ANT 2 connectors**

Connect your primary HF/ 50 MHz antenna to ANT 1. If you are using 2 antennas for the HF/ 50 MHz band, connect the secondary antenna to the ANT 2 connector.

**2 GND post**

Connect a heavy gauge wire or copper strap between the ground post and the nearest earth ground {page 1}.

**3 KEY and PADDLE jacks**

The PADDLE jack mates with a 6.3 mm (1/4") 3-conductor plug for connecting a keyer paddle to the internal electronic keyer. The KEY jack mates with a 3.5 mm (1/8") 2-conductor plug for connecting an external key for CW operation. Read "Keys for CW (PANEL and KEY)" {page 3} before using these jacks.

**4 AT connector**

Mates with the connector on the cable supplied with the external antenna tuner. Refer to the instruction manual supplied with the tuner for more information.

**5 ANT 144**

Connect your 144 MHz band antenna to this connector.

**6 ANT 430**

Connect your 430/ 440 MHz band antenna to this connector.

**7 ANT 1.2G (TS-2000/ TS-B2000 Optional)**

Connect your 1.2 GHz band antenna to this connector.

**8 DC 13.8V power input connector**

Connect a 13.8 V DC power source to this connector {page 2}. Use the cable supplied with the regulated DC power supply.

**9 COM connector**

Mates with a 9-pin female RS-232C connector for connecting a computer via one of its serial communication ports {page 93}. Also used with the Quick Data Transfer function {page 93}.

**10 PANEL connector**

Connect a cable from the optional separate remote panel (RC-2000) to this connector.

**11 EXT.SP1 and EXT.SP2 jacks**

Mate with a 3.5 mm (1/8"), 2-conductor (mono) plugs for connecting external speakers {pages 3, 78}.

**12 EXT.CONT connector**

Connect your 50 MHz, 144 MHz, 430/ 440 MHz or 1.2 GHz linear amplifier control cable to this connector {page 76}.

**13 ACC2 connector**

Mates with a 13-pin male DIN connector for connecting various accessory equipment, such as an external TNC/ MCP or a RTTY terminal {page 94}.

**14 REMOTE connector**

Mates with a 7-pin male DIN connector for connecting an HF linear amplifier {page 76}. Do not connect 50 MHz, 144 MHz, 430/ 440 MHz, or 1.2 GHz linear amplifier controls to this connector; use the **EXT.CONT** connector instead.

**15 HF RX ANT connector**

Connect a separate receive-only antenna for HF low bands to this jack (RCA connector) {page 76}.

## 4 GETTING ACQUAINTED

### DISPLAY

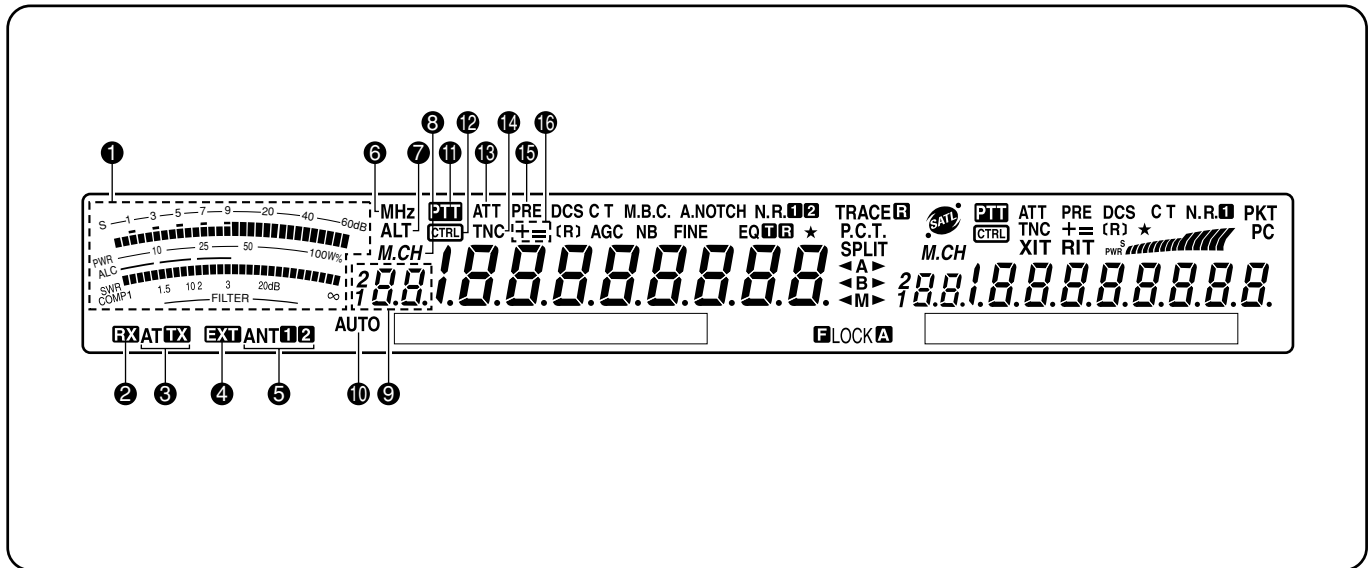

#### 1 METER

While receiving, serves as an S-meter to measure and display the received signal strength. It also displays the filter width. While transmitting, serves as a power meter plus an ALC meter, an SWR meter, or a Speech Processor compression meter. The Peak Hold function holds each reading for approximately half a second.

**Note:** SWR meter works only for the HF and 50 MHz bands.

#### 2 RX

Appears while the internal antenna tuner {page 72} or an external antenna tuner is in-line for the HF/ 50 MHz band reception.

#### 3 AT TX

Appears while the internal antenna tuner {page 72} or an external antenna tuner is in-line for the HF/ 50 MHz band transmission.

#### 4 EXT

Appears while HF RX ANT {page 76} connector is enabled to receive HF band signals. You cannot transmit the signals through this connector.

#### 5 ANT 1 2

Either "ANT 1" or "ANT 2" appears, depending on whether the Antenna 1 connector or the Antenna 2 connector is selected for the HF/ 50 MHz band {page 72}.

#### 6 MHz

Appears when the MHz Up/ Down mode using the MULTI/ CH control is switched ON {page 37}.

#### 7 ALT

Appears when ALT (Auto Lock Tuning) is activated for the 1.2 GHz (FM) band {page 72}.

#### 8 M.CH

Appears while Memory Recall or Memory Scroll is being used {page 59}.

#### 9 ?88

Shows the memory channel number for the main transceiver. If you select a channel over 99, a leading digit (1 or 2) appears (the memory number ranges from 00 to 299). It also shows the Quick Memory number location (the Quick Memory number ranges from "0\_" to "9\_").

#### 10 AUTO

Appears when Auto mode selection is activated {page 73}.

#### 11 PTT

Appears when the main transceiver is selected for the transmission band.

#### 12 CTRL

Appears when the main transceiver's functions can be controlled using the front panel keys.

#### 13 ATT

Appears when the main transceiver's receiver attenuator (approx. 12 dB) is ON {pages 57, 73}.

#### 14 TNC

Appears when the internal TNC is assigned to the main transceiver {page 49}.

#### 15 PRE

Appears when the receiver pre-amplifier of the main transceiver is ON {page 57}.

#### 16 + =

"+" or "-" appears, indicating which offset direction is selected for the main transceiver. "=" appears when the -7.6 MHz (430 MHz) or -6.0 MHz (1.2 GHz) offset is selected (all E-types only) {page 32}.



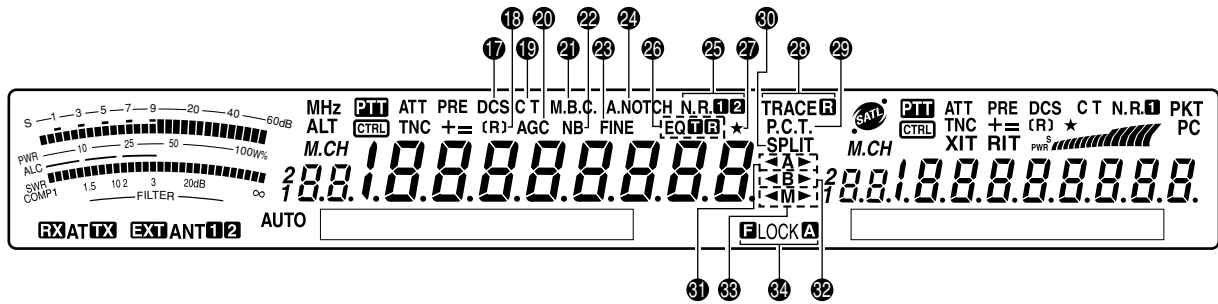

#### 17 DCS

Appears when the DCS (Digital Code Squelch) of the main transceiver is ON {page 36}.

#### 18 [R]

“R” appears when the Reverse function of the main transceiver is ON. “[R]” appears when the ASC (Automatic Simplex Check) of the main transceiver is activated {page 34}.

#### 19 C T

“T” appears when the Tone function of the main transceiver is ON {page 33}. “C T” appears when the Continuous Tone Coded Squelch System (CTCSS) of the main transceiver is ON {page 35}.

#### 20 AGC

Appears when the AGC (Automatic Gain Control) of the main transceiver is ON {page 38}. Disappears when the AGC is OFF.

#### 21 M.B.C.

“B.C.” appears when the automatic Beat Cancellor is ON. “M.B.C.” appears when the single Beat Cancel frequency is manually controlled {page 56}.

#### 22 NB

Appears when the Noise Blanker is ON {page 57}.

#### 23 FINE

Appears when the Fine function for the main Tuning control is ON {page 38}.

#### 24 A.NOTCH

Appears when the DSP Auto Notch function of the main transceiver is ON {page 56}.

#### 25 N.R. 1 2

“N.R. 1” or “N.R. 2” appears, depending on whether DSP Noise Reduction 1 (Line Enhanced method) or Noise Reduction 2 (SPAC method) of the main transceiver is selected {page 56}.

#### 26 EQ T R

“EQ T” appears when the TX Equalizer function is ON. “EQ R” appears when the RX Equalizer function of the main transceiver is ON {pages 41, 78}.

#### 27 ★

Appears when the Quick Menu function of the transceiver is ON {page 21}. It also appears when the frequency point of Program Scan Partially Slowed is selected on the main-transceiver {page 67}.

#### 28 TRACE R

“TRACE” appears when the Trace function is ON while in Satellite mode. “TRACE R” appears when the Reverse Trace function is ON {page 53}.

#### 29 P.C.T.

Appears when Packet Cluster Tune mode is ON {page 53}.

#### 30 SPLIT

Appears when the transmit frequency differs from the receive frequency {page 31}.

#### 31 ◀ A ▶

“◀ A” or “A ▶” appears while VFO A is selected {page 18}. “A” appears while Menu A is being accessed {page 21}.

#### 32 ◀ B ▶

“◀ B” or “B ▶” appears while VFO B is selected {page 18}. “B” appears while Menu B is being accessed {page 21}.

#### 33 ◀ M ▶

“◀ M” or “M ▶” appears while a simplex memory channel is selected {page 59}. “◀ M ▶” appears while a split frequency memory channel is selected {page 60}.

#### 34 FLOCK A

“FLOCK” appears when the Frequency Lock function is ON. “LOCK A” appears when the Lock All key function is ON {page 77}.

## 4 GETTING ACQUAINTED

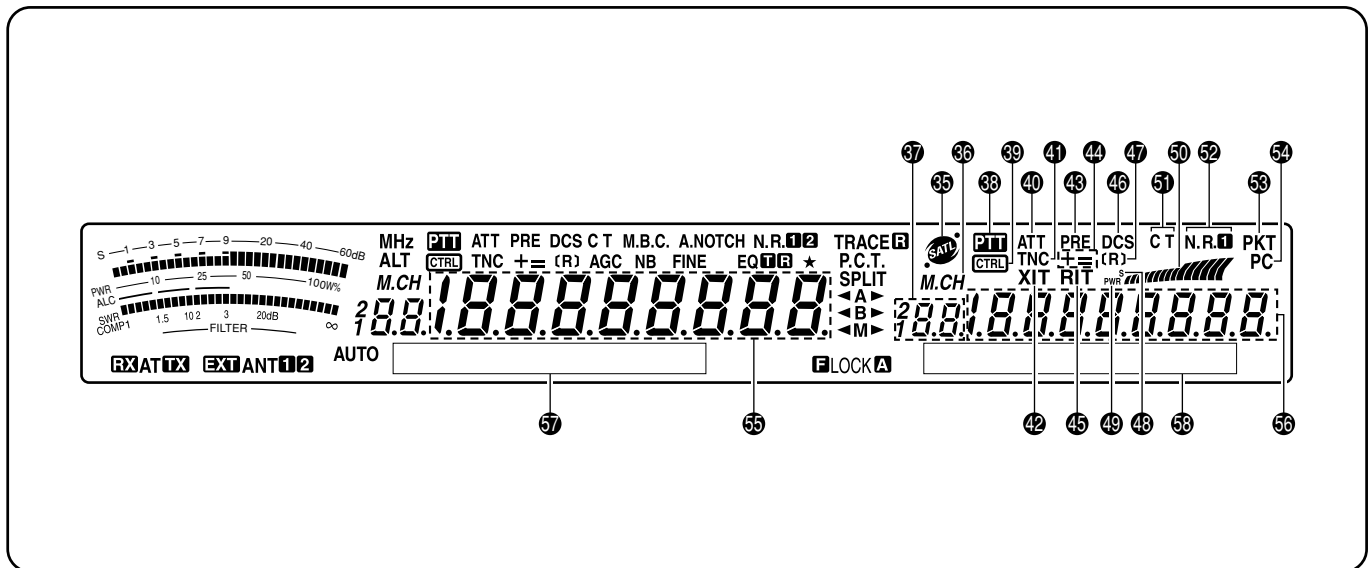

35 **SATL**

Appears while in Satellite mode {page 53}.

36 **M.CH**

Appears while Memory Recall or Memory Scroll is being used for the sub-receiver {page 59}.

37 **???.**

Shows the memory channel number for the sub-receiver. If you select a channel over 99, a leading digit (1 or 2) appears (the memory number ranges from 00 to 299).

38 **PTT**

Appears when the sub-receiver is selected for the transmission band.

39 **CTRL**

Appears when the sub-receiver's functions can be controlled using the front panel keys.

40 **ATT**

Appears when the sub-receiver's receive attenuator (approx. 12 dB) is ON {pages 57, 73}.

41 **TNC**

Appears when the internal TNC is assigned to the sub-receiver.

42 **XIT**

Appears when Transmit Incremental Tuning of the main transceiver is ON {page 40}.

43 **PRE**

Appears when the receiver pre-amplifier of the sub-receiver is ON {page 57}.

44 **+ =**

“+” or “-” appears, indicating which offset direction is selected for the sub-receiver. “=” appears when the -7.6 MHz (430 MHz) or -6.0 MHz (1.2 GHz) offset is selected (all E-types only) {page 32}.

45 **RIT**

Appears when Receive Incremental Tuning of the main transceiver is ON {page 38}.

46 **DCS**

Appears when the DCS (Digital Code Squelch) of the sub-receiver is ON {page 36}.

47 **[R]**

“R” appears when the Reverse function of the sub-receiver is ON. “[R]” appears when the ASC (Automatic Simplex Check) of the sub-receiver is activated {page 34}.

48 **S**

Appears when the sub-receiver meter shows the signal strength level {page 46}.

49 **PWR**

Appears when the sub-receiver meter shows the output power level {page 20}.

50

Serves as an S-meter to measure and display the received signal strength for the sub-receiver. It also displays the relative output power when the sub-band is selected for the transmission.

51 **CT**

“T” appears when the Tone function of the sub-receiver is ON {page 33}. “C T” appears when the Continuous Tone Coded Squelch System (CTCSS) of the sub-receiver is ON {page 35}.

52 **N.R.1**

Appears when the DSP Noise Reduction 1 of the sub-receiver is activated {page 56}.

53 **PKT**

Appears when the internal TNC is operating in Packet mode {page 49}.

**54 PC**

Appears when the TS-2000(X) is being controlled by a PC {page 81}.

**55 1.8.8.8.8.8.8.8**

The main transceiver operating frequency display.

**56 1.8.8.8.8.8.8.8**

When the sub-receiver is switched ON, it shows the receive frequency for the sub-receiver. However, if you are controlling the main transceiver functions, such as RIT, XIT, or SPLIT, it is used to display the frequency information for these functions {page 45}.

**57 MAIN dot-matrix display**

In the normal operating mode, it displays the operating mode for the main transceiver. It is also used to display various control information, such as menu numbers and settings and the DSP filter configuration.

**58 SUB dot-matrix display**

In the normal operating mode, it displays the operating mode for the sub-receiver. It is also used to display various control information, such as menu information and the DSP filter frequency configuration.

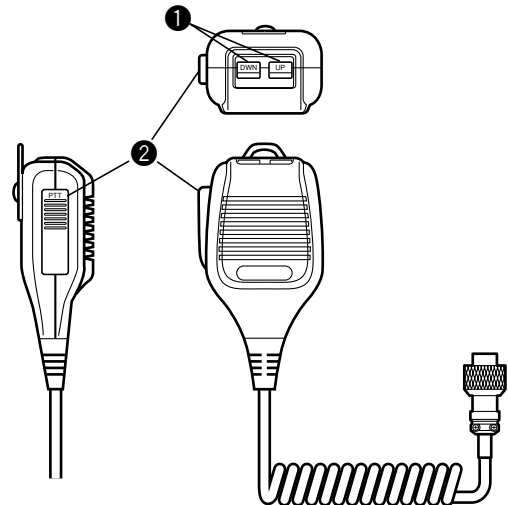
**MICROPHONE****1 UP/ DWN keys**

Use these keys to step the VFO frequency, memory channels, or Menu selections up and down. Press and hold these keys to continuously change the settings.

**2 PTT (Push-to-Talk) switch**

The transceiver is placed in transmit mode when this non-locking switch is held down. Releasing the switch returns the transceiver to receive mode.

# OPERATING BASICS

## SWITCHING POWER ON/OFF

- 1 Switch the DC power supply ON.
- 2 Press and hold [  $\phi$  ] (POWER) briefly to switch the transceiver ON.
  - Do not press the switch for more than approximately 2 seconds; the transceiver will be switched OFF.
  - Upon power up, "HELLO" appears, followed by the selected frequency and other indicators.

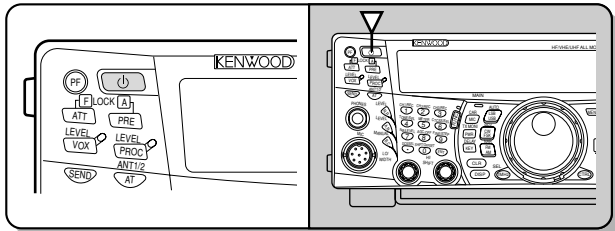

- 3 To switch the transceiver OFF, press [  $\phi$  ] (POWER) again.
- 4 Switch the DC power supply OFF.
  - You may skip step 3. After switching the transceiver ON, you can switch it OFF or ON using only the power switch of the DC power supply. The transceiver stores the information of the POWER switch position when the DC power source is switched OFF.

## ADJUSTING VOLUME

### AUDIO FREQUENCY (AF) GAIN

Turn the **MAIN AF** control clockwise to increase the audio level and counterclockwise to decrease the level.

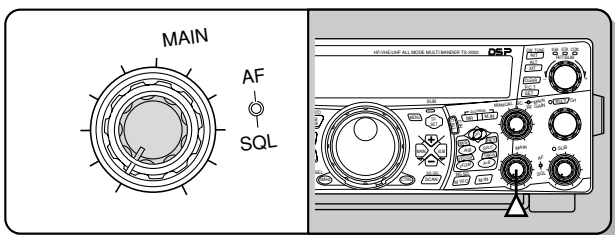

#### Note:

- ◆ The position of the **MAIN AF** control does not affect the volume of beeps caused by pressing keys nor the CW transmit sidetone. The audio level for Packet operation is also independent of the **MAIN AF** control setting.
- ◆ When the optional RC-2000 is installed, you can control the volume with the AF controls on both the transceiver and the RC-2000. However, when turning the transceiver on, the volume settings of the RC-2000 have priority.

## RADIO FREQUENCY (RF) GAIN

Set the **MAIN RF GAIN** control fully clockwise. You may turn it counterclockwise slightly when you have trouble hearing the desired signal because of excessive atmospheric noise or interference from other stations. First take note of the peak S-meter reading of the desired signal. Then turn the **MAIN RF GAIN** control counterclockwise until the S-meter reads the peak value that you noted. Signals that are weaker than this level will be attenuated and reception of the station will become easier.

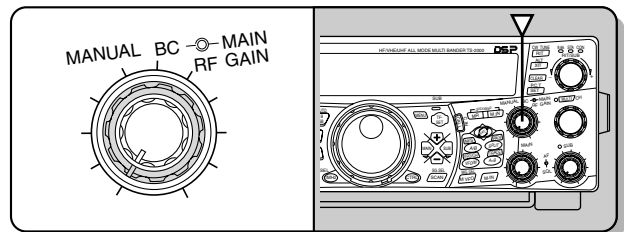

Depending on the type and gain of your antenna, and the condition of the band, you may also prefer leaving the **MAIN RF GAIN** control turned counterclockwise by the same amount rather than turning it fully clockwise. When using FM mode, always set the **MAIN RF GAIN** control fully clockwise.

## SELECTING VFO A OR VFO B

2 VFOs are available for controlling the frequency on the main transceiver. Each VFO, VFO A and VFO B, works independently so that a different frequency and mode can be selected. When SPLIT operation is activated, VFO A is used for reception and VFO B is used for transmission. The opposite combination is also possible.

Press [A/B] to toggle between VFO A and VFO B.

- "◀A" or "◀B" appears to indicate which VFO is selected.

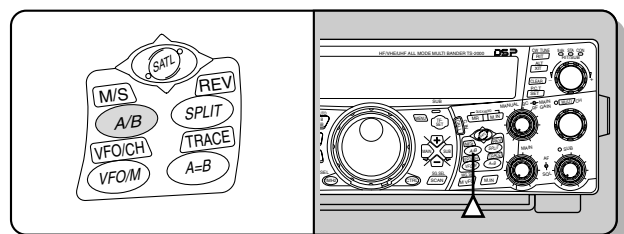

## SELECTING A BAND

Press [ + ] / [ - ] to select your desired band.

- Holding down either key changes the bands continuously.

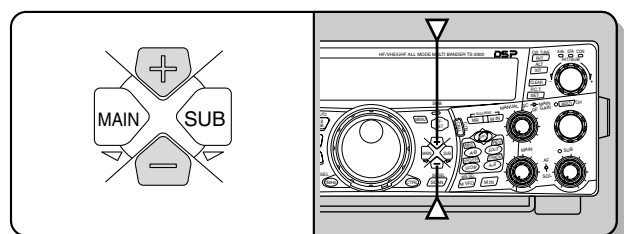

## SELECTING A MODE

Press **[LSB/ USB/ AUTO]**, **[CW/ FSK/ REV]**, or **[FM/ AM/ NAR]**. To select the second mode on each key, press the same key again. For example, each press of **[LSB/ USB/ AUTO]** toggles between LSB and USB mode.

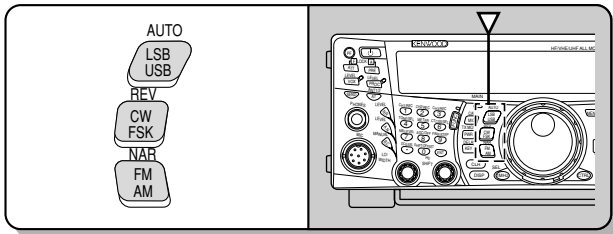

Press **[FUNC]**, **[LSB/ USB/ AUTO]** to toggle the Auto Mode selection. When it is active, "AUTO" appears. If you change the frequency above or below 9.5 MHz, the transceiver automatically switches modes; LSB for frequencies under 9.5 MHz and USB for frequencies equal to or above 9.5 MHz (HF/ 50 MHz band). As for the 144 MHz, 430/ 440 MHz, and 1.2 GHz bands, the transceiver automatically changes the operating mode to FM. You can further add the frequency table data to change the mode automatically {page 73}.

## ADJUSTING SQUELCH

The purpose of the Squelch is to mute the speaker when no signals are present. With the squelch level correctly set, you will hear sound only while actually receiving signals. The higher the selected squelch level, the stronger the signals must be to receive. The appropriate squelch level depends on the ambient RF noise conditions.

Turn the **MAIN SQL** control, when there are no signals present, to select the squelch level at which the background noise is just eliminated; the **MAIN** band LED will turn off. Many ham operators prefer leaving the **MAIN SQL** control fully counterclockwise unless operating on a full-carrier mode such as FM. The squelch level for the main transceiver is preset at the factory to approximately 9 o'clock for FM and 11 o'clock for SSB and AM.

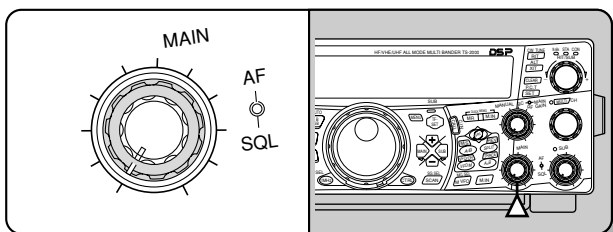

## SELECTING A FREQUENCY

Turn the **Tuning** control clockwise or press Mic **[UP]** to increase the frequency. Turn the **Tuning** control counterclockwise or press Mic **[DWN]** to decrease the frequency.

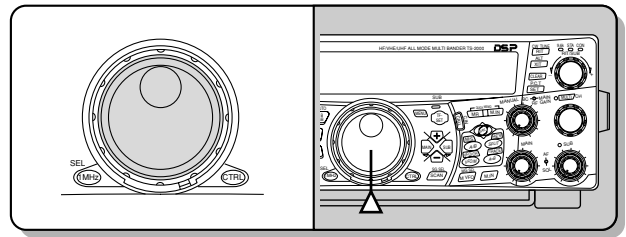

You may prefer directly entering a frequency using the numeric keypad if the desired frequency is far from the current frequency. Press **[ENT]**, then press the numeric keys as necessary. For details, see "Direct Frequency Entry" {page 37}.

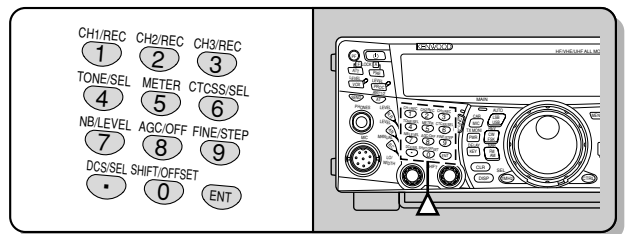

This transceiver provides many other methods for quickly selecting a frequency. For further information, see "SELECTING YOUR FREQUENCY" {page 37}.

## FRONT PANEL METER

The multi-function meter measures the parameters in the table below. The S-meter and FILTER scales appear when the main transceiver is in receive mode, and the PWR meter appears when it is in transmit mode. Each press of **[5/ METER]** switches among the ALC, SWR, and COMP meters. Peak readings for the S-meter, ALC, SWR, COMP, and PWR functions are held momentarily.

Meter	What Is Measured?
S	Strength of received signals
PWR	Transmit output power
ALC	Automatic level control status
SWR	Antenna system standing wave ratio
COMP	Speech compression level when using the Speech Processor {page 40}
FILTER	DSP filter width

### Note:

- ◆ The COMP meter functions only when the Speech Processor is ON for SSB, FM, or AM mode.
- ◆ The PWR indicator shows the output power level as a percentage on the 1.2 GHz band.
- ◆ The SWR meter works only for ANT 1 and ANT 2 (HF/ 50 MHz band).
- ◆ Peak Hold readings cannot be deactivated.

## 5 OPERATING BASICS

### TRANSMITTING

For voice communications, press [**SEND**] or press and hold Mic [**PTT**], then speak into the microphone in your normal tone of voice. When you finish speaking, press [**SEND**] again or release Mic [**PTT**].

To transmit CW, press [**VOX/ LEVEL**] to switch the Break-in function ON, then close the key or keyer paddle. Connect a key or keyer paddle {pages 3, 39}, then select CW mode.

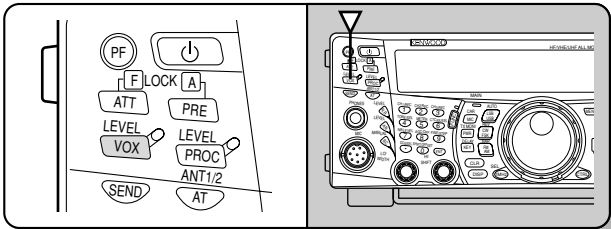

For a detailed explanation on transmitting, see “BASIC COMMUNICATIONS”, beginning on page 28.

**Note:** When using AM, CW, or FSK mode, you may adjust the carrier level. In general, adjust the level so that the ALC meter reads within the limits of the ALC zone. For the adjustment procedures, refer to the instructions for each mode in “TRANSMISSION” {pages 28, 29, 30}.

### SELECTING TRANSMIT POWER

It is wise to select a lower transmit power if communication is still reliable. This lowers the risk of interfering with others on the band. When operating from battery power, selecting a lower transmit power allows you more operating time before a charge is necessary. This transceiver allows you to change the transmit power even while transmitting.

#### 1 Press [**PWR/ TX MONI**].

- The current transmit power appears.

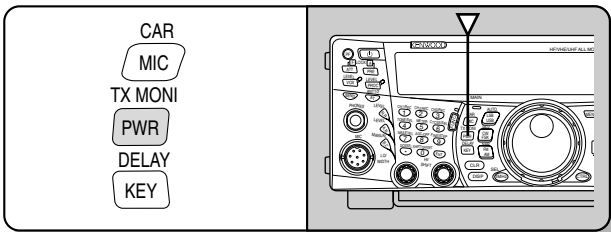

#### 2 Turn the **MULTI/ CH** control counterclockwise to reduce the power or clockwise to increase the power.

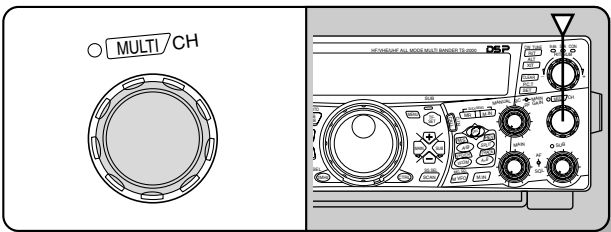

- The selectable range differs, depending on the current band and mode.

#### 3 Press [**PWR/ TX MONI**] to complete the setting.

**Note:** You may access Menu No. 23, “FINE TRANSMIT POWER TUNING”, and select “ON” (press [+]) to change the step size from 5 W to 1 W {page 79}.

### MICROPHONE GAIN

The microphone gain must be adjusted when SSB or AM mode is used without speech processing {pages 28, 29}.

#### 1 Press [**MIC/ CAR**].

- The current microphone gain level appears. The default is 50; the range is from 0 to 100.

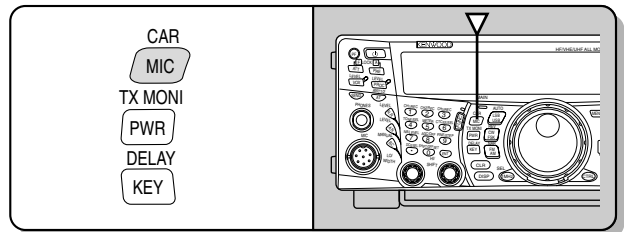

#### 2 Press [**SEND**] or press and hold Mic [**PTT**].

- The **MAIN** band LED lights red.

#### 3 SSB: While speaking into the microphone, adjust the **MULTI/ CH** control so that the ALC meter reflects your voice level, but does not exceed the ALC limit.

AM: While speaking into the microphone, adjust the **MULTI/ CH** control so that the calibrated power meter slightly reflects your voice level.

CW, FSK: While transmitting, adjust the **MULTI/ CH** control so that the ALC meter reflects the carrier level within the ALC zone.

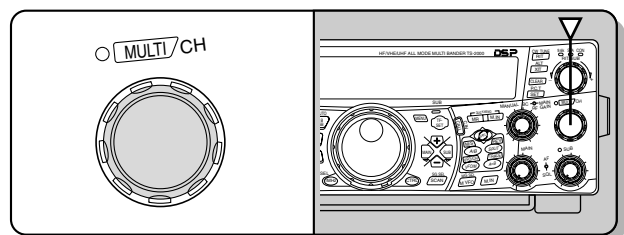

#### 4 Press [**SEND**] or release Mic [**PTT**].

- The **MAIN** band LED lights green or turns off, depending on the MAIN SQL control setting.

#### 5 Press [**MIC/ CAR**].

For FM mode, access Menu No. 41 {page 28} and select “LOW”, “MID”, or “HIGH” for the microphone gain.

**Note:** When using the optional MC-90 microphone in FM mode, select “HIGH” for the microphone gain. The microphone sensitivity is low in FM mode. This may cause insufficient modulation. For other microphones, select either “LOW” or “MID”.

# MENU SETUP

## WHAT IS A MENU?

Many functions on this transceiver are selected or configured via a software-controlled Menu, rather than through the physical controls of the transceiver. Once familiar with the Menu system, you will appreciate the versatility it offers. You can customize the various timings, settings, and programming functions on this transceiver to meet your needs without using many controls and switches.

## MENU A/ MENU B

This transceiver has two menus: Menu A and Menu B. These menus contain identical functions and can be configured independently. The transceiver, therefore, allows you to switch between two different environments quickly and easily. For example, you can configure Menu A for DXing and contesting while Menu B is for the relaxed local ragchewing. By switching from Menu A to Menu B, you can instantly change the Menu configuration and key assignment to suit your current operating style. Or, two operators may share a single transceiver by dedicating one Menu to each operator. Both operators can always enjoy their own configuration.

## MENU ACCESS

- 1 Press **[MENU]**.
  - The Menu No. and setting appear on the main dot-matrix display, and the explanation of the menu appears on the sub dot-matrix display.



- 2 Press **[A/B]** to select Menu A or Menu B.
  - "A" or "B" appears, indicating which Menu is selected.
- 3 Turn the **MULTI/ CH** control to select the desired Menu No.
  - Each time you change the Menu No., a different scrolling message appears on the sub dot-matrix display, describing the Menu No.
  - You will see "PUSH SUB" if there are sub-menus in the Menu No. Pressing **[SUB]** allows you to select from among the sub-menus. Press **[MAIN]** to exit the sub-menu selection.
- 4 Press **[+]**, **[-]**, Mic **[UP]/ [DWN]** to select a parameter.
- 5 Press **[MENU]** to exit Menu mode.

## QUICK MENU

Because the number of functions this transceiver provides is extraordinary, there are numerous items in each Menu. If you find accessing desired Menu Nos. to be too time consuming, use the Quick Menu to create your own customized, abbreviated Menu. You can then add those Menu Nos. which you frequently use, to the Quick Menu. Copying Menu Nos. to the Quick Menu has no effect on the Menu.

## PROGRAMMING THE QUICK MENU

- 1 Press **[MENU]**.
- 2 Turn the **MULTI/ CH** control to select the desired Menu No.
- 3 Press **QUICK MEMO [M.IN]**.
  - A star appears, indicating that the Menu item has been added to the Quick Menu.

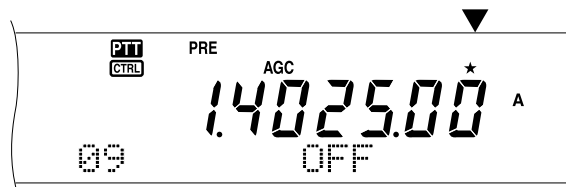

- To remove the item from the Quick Menu, press **QUICK MEMO [M.IN]** again.
- 4 Press **[MENU]** to exit Menu mode.

**Note:** You cannot add a sub menu No. to the Quick Menu. Press **[MAIN]** to go back to the main menu No., then press **QUICK MEMO [M.IN]** to add the menu No. to the Quick Menu.

## USING THE QUICK MENU

- 1 Press **[MENU]**.
- 2 Press **[1MHz/ SEL]**.
  - "MHz" appears.

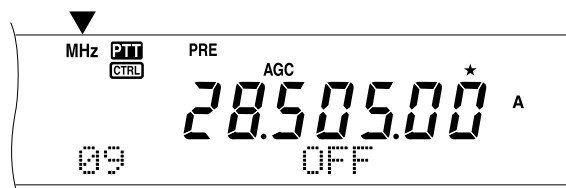

- 3 Turn the **MULTI/ CH** control to select the desired Quick Menu No.
- 4 Press **[+]**, **[-]**, Mic **[UP]/ [DWN]** to change the current setting for the selected Menu No.
- 5 Press **[MENU]** to exit Quick Menu mode.

**Note:** If the Quick Menu has not been programmed, turning the **MULTI/ CH** control in step 2 causes "CHECK" to be output in Morse code.

## 6 MENU SETUP

### MENU CONFIGURATION

Group	Menu No.	Function	Selections	Default	Ref. Page	
Operator Interface	00	Display brightness OFF, 1: minimum, 4: maximum	OFF/ 1 to 4	3	75	
	01	Key illumination	ON/ OFF	ON	75	
Tuning Control	02	Tuning control change per revolution	500/ 1000	1000	38	
	03	Tuning with <b>MULTI/ CH</b> control	ON/ OFF	ON	37	
	04	Rounds off VFO frequencies changed by using the <b>MULTI/ CH</b> control	ON/ OFF	ON	37	
	05	9 kHz frequency step size for the <b>MULTI/ CH</b> control in AM mode on the AM broadcast band	ON/ OFF	See Reference Page	37	
Memory Channel	06	Memory Channel	Press SUB to access the sub-menu	–	–	
	06A	Memory-VFO split operation	ON/ OFF	OFF	60	
	06B	Tunable (ON) or fixed (OFF) memory channel frequencies	ON/ OFF	OFF	60	
Scan Operation	07	Program scan partially slowed	ON/ OFF	ON	67	
	08	Slow down frequency range for the Program scan	100/ 200/ 300/ 400/ 500 Hz	300 Hz	67	
	09	Program scan hold	ON/ OFF	OFF	68	
	10	Scan resume method	TO (Time-Operated)/ CO (Carrier-Operated)	TO	68	
	11	Visual scan range	31/ 61/ 91/ 181 channels	61 channels	70	
Monitor Sound	12	Beep output level OFF, 1: minimum, 9: maximum	OFF/ 1 to 9	4	74	
	13	TX sidetone volume OFF, 1: minimum, 9: maximum	OFF/ 1 to 9	5	44	
	14	DRU-3A playback volume OFF, 1: minimum, 9: maximum	OFF/ 1 to 9	4	89	
	15	VS-3 playback volume OFF, 1: minimum, 9: maximum	OFF/ 1 to 9	4	91	
Speaker Output	16	Audio output configuration for EXT.SP2 or headphone		0	78	
		0	SP1 (L) : Main/ Sub Mix SP2 (R): Main/ Sub Mix			0/ 1/ 2
		1	SP1 (L) : Main SP2 (R): Sub			
	2	SP1 (L) : Main + 1/4 Sub Mix SP2 (R): Sub + 1/4 Main Mix				
	17	Reverses the EXT.SP1 and EXT.SP2 (the headphone jack L/R channels) audio outputs		ON/ OFF	OFF	78



## 6 MENU SETUP

Group	Menu No.	Function	Selections	Default	Ref. Page
RX Antenna	18	Enable an input from the HF RX ANT connector	ON/ OFF	OFF	76
S-meter Squelch	19	S-meter squelch	Press SUB to access the sub-menu	–	–
	19A	Enable S-meter squelch	ON/ OFF	OFF	78
	19B	Hang time for S-meter squelch	OFF/ 125/ 250/ 500 ms	OFF	78
DSP Equalizer	20	DSP RX equalizer OFF: Flat H BOOST: High boost F PASS: Formant pass B BOOST: Bass boost CONVEN: Conventional USER: Flat (Reserved for ARCP software)	OFF/ H BOOST/ F PASS/ B BOOST/ CONVEN/ USER	OFF	78, 104
	21	DSP TX equalizer OFF: Flat H BOOST: High boost F PASS: Formant pass B BOOST: Bass boost CONVEN: Conventional USER: Flat (Reserved for ARCP software)	OFF/ H BOOST/ F PASS/ B BOOST/ CONVEN/ USER	OFF	41, 104
DSP Filter	22	DSP TX filter bandwidth for SSB or AM	2.0/ 2.2/ 2.4/ 2.6/ 2.8/ 3.0 kHz	2.4 kHz	41
Fine Tuning	23	Fine transmit power tuning	ON/ OFF	OFF	38
TOT	24	Time-out timer	OFF/ 3/ 5/ 10/ 20/ 30 minutes	OFF	78
Transverter	25	Transverter frequency display	OFF/ ON	OFF	79
Antenna Tuner	26	TX hold when AT completes the tuning	OFF/ ON	OFF	73
	27	In-line AT while receiving	OFF/ ON	OFF	73
Linear Amplifier	28	Linear amplifier control	Press SUB to access the sub-menu	–	–
	28A	Linear amplifier control delay for HF band	OFF/ 1/ 2	OFF	76
	28B	Linear amplifier control delay for 50 MHz band	OFF/ 1/ 2	OFF	76
	28C	Linear amplifier control delay for 144 MHz band	OFF/ 1/ 2	OFF	76
	28D	Linear amplifier control delay for 430/ 440 MHz band	OFF/ 1/ 2	OFF	76
	28E	Linear amplifier control delay for 1.2 GHz band	OFF/ 1/ 2	OFF	76
Message Playback	29	Voice and CW message playback	Press SUB to access the sub-menu	–	–
	29A	Repeat the playback	OFF/ ON	OFF	44, 90
	29B	Interval time for repeating the playback	0 to 60 seconds (in steps of 1 second)	10 sec.	44, 90

## 6 MENU SETUP

Group	Menu No.	Function	Selections	Default	Ref. Page
CW	30	Keying priority over playback	OFF/ ON	OFF	44
	31	CW RX pitch/ TX sidetone frequency	400 to 1000 Hz (in steps of 50 Hz)	800 Hz	30
	32	CW rise time	1/ 2/ 4/ 6 ms	6 ms	77
	33	CW keying dot, dash weight ratio	AUTO/ 2.5 to 4.0 (in steps of 0.1 )	AUTO	42
	34	Reverse CW keying auto weight ratio	OFF/ ON	OFF	42
	35	Bug key mode	OFF/ ON	OFF	43
	36	Auto CW TX in SSB mode	OFF/ ON	OFF	44
	37	Frequency correction for changing SSB to CW	OFF/ ON	OFF	44
FSK	38	FSK shift	170/ 200/ 425/ 850 Hz	170 Hz	51
	39	FSK keying polarity	NORMAL/ INVERS	NORMAL	51
	40	FSK tone frequency	1275/ 2125 Hz	2125 Hz	51
FM	41	Mic gain for FM	LOW/ MID/ HIGH	LOW	20
	42	Sub-tone mode for FM	BURST/ CONT	See reference page	33
	43	Auto repeater offset	OFF/ ON	ON	34
	44	TX hold: 1750 Hz tone	OFF/ ON	OFF	33
DTMF	45	DTMF functions	Press SUB to access the sub-menu	–	–
	45A	DTMF number memory select	Press SUB to access the sub-menu	–	–
	45B	TX speed for stored DTMF number	SLOW/ FAST	FAST	76
	45C	Pause duration for stored DTMF number	100/ 250/ 500/ 750/ 1000/ 1500/ 2000 ms	500 ms	76
	45D	Enable Mic remote control	OFF/ ON	OFF	81
TNC	46	MAIN/ SUB band: Internal TNC	MAIN/ SUB	SUB	50
	47	Data transfer speed: Internal TNC	1200/ 9600 bps	1200 bps	50
	48	DCD sensing band	TNC BAND/ MAIN & SUB	TNC band	50
	49	P.C.T. (Packet Cluster Tune) mode	Press SUB to access the sub-menu	–	–
	49A	Packet Cluster Tune mode	MANUAL/ AUTO	MANUAL	53
	49B	Packet Cluster RX confirmation tone	OFF/ MORSE/ VOICE	MORSE	53
	50	Packet configuration	Press SUB to access the sub-menu	–	–
	50A	Packet filter bandwidth	OFF/ ON	OFF	50
	50B	AF input level for Packet	0 to 9 (in steps of 1)	4	50
	50C	MAIN band AF output level for packet operation	0 to 9 (in steps of 1)	4	50
	50D	SUB band AF output level for packet operation	0 to 9 (in steps of 1)	4	50
	50E	MAIN/ SUB band: External TNC	MAIN/ SUB	MAIN	50
	50F	Data transfer speed: External TNC	1200/ 9600 bps	1200 bps	50

## 6 MENU SETUP

Group	Menu No.	Function	Selections	Default	Ref. Page
PF keys	51	PF key assignment	Press SUB to access the sub-menu	–	–
	51A	Front panel PF key	OFF/ A.N./ B.C./ N.R./ NB/ ANT 1/2/ 1MHz/ CTRL/ CALL/ CLR/ FINE/ CH3/ CH2/ CH1/ CW TUNE/ M.IN/ M▶VFO/ SCAN/ A=B/ VFO/M/ A/B/ TF-SET/ SPLIT/ Q M.IN/ Q MR/ DSP MONI/ RX MONI/ VOICE2/ VOICE1/ MENU 00-62	VOICE1	77
	51B	Microphone PF1 (CALL) key	Same as 51A	A/B	77
	51C	Microphone PF2 (VFO) key	Same as 51A	SPLIT	77
	51D	Microphone PF3 (MR) key	Same as 51A	VFO/M	77
	51E	Microphone PF4 (PF) key	Same as 51A	RX MONI	77
Master/ Slave operation	52	Split frequency transfer in master/ slave operation	OFF/ ON	OFF	80
	53	Permit to write the transferred Split frequencies to the target VFOs	OFF/ ON	OFF	80
TX Inhibit	54	TX inhibit	OFF/ ON	OFF	41
Packet	55	Packet communication mode	OFF/ ON	OFF	49
	56	COM port communication speed	4800/ 9600/ 19200/ 38400/ 57600 bps	9600 bps	50
APO	57	APO (Auto Power Off) function	OFF/ 60/ 120/ 180 minutes	OFF	72
RC-2000 Configuration	58	RC-2000 font in easy operation mode	FONT1/ FONT2	FONT1	98
	59	RC-2000 panel/ TS-2000(X) dot-matrix display contrast	1 to 16 (in steps of 1)	8	75
	60	Display mode for RC-2000	NEGATIVE/ POSITIVE	POSITIVE	98
TS-2000 Repeater Functions (K-type Only)	61	Repeater function	Press SUB to access the sub-menu	–	–
	61A	Repeater mode select	OFF/ LOCKED/ CROSS	OFF	88
	61B	Repeater TX hold	OFF/ ON	OFF	88
	61C	Remote control ID code	000 to 999	000	82
	61D	Acknowledgement signal in external remote control mode	OFF/ ON	OFF	82
	61E	External remote control	OFF/ ON	OFF	82

## 6 MENU SETUP

Group	Menu No.	Function	Selections	Default	Ref. Page
Sky Command II+ (K-type Only)	62	Sky Command II+ configuration	Press SUB to access the sub-menu	–	–
	62A	Commander callsign for Sky Command II+	Input a callsign for the Commander	NO CALL	83
	62B	Transporter callsign for Sky Command II+	Input a callsign for the Transporter	NO CALL	83
	62C	Sky Command II+ tone frequency	38 CTCSS tones	88.5 Hz	83
	62D	Sky Command II+ communication speed	1200/ 9600 bps	1200 bps	83
	62E	Sky Command II+ mode	OFF/ CLIENT/ COMMAND/ T-PORTER	OFF	83

## ALPHABETICAL FUNCTION LIST

Function	Menu No.
<b>AMPLIFIER</b>	
Linear amplifier control delay for HF band	28A
Linear amplifier control delay for 50 MHz band	28B
Linear amplifier control delay for 144 MHz band	28C
Linear amplifier control delay for 430/ 440 MHz band	28D
Linear amplifier control relay for 1.2 GHz band	28E
<b>ANTENNA</b>	
Enable an input from the HF RX ANT connector	18
<b>ANTENNA TUNER</b>	
In-line AT while receiving	27
TX hold when AT completes the tuning	26
<b>BEEP FUNCTION</b>	
Beep output level	12
<b>CW</b>	
Auto CW TX in SSB mode	36
Bug key mode	35
CW keying dot, dash weight ratio	33
CW rise time	32
CW RX pitch/ TX sidetone frequency	31
Frequency correction for changing SSB to CW	37
Keying priority over playback	30
Reverse CW keying auto weight ratio	34
<b>DATA TRANSFER</b>	
Permit to write the transferred Split frequencies to the target VFOs.	53
Split frequency transfer in master/ slave operation	52

Function	Menu No.
<b>DSP FILTER</b>	
DSP RX equalizer	20
DSP TX equalizer	21
DSP TX filter bandwidth for SSB or AM	22
<b>DTMF</b>	
DTMF number memory select	45A
Pause duration for stored DTMF number	45C
TX speed for stored DTMF number	45B
<b>FM</b>	
Auto repeater offset	43
Enable S-meter squelch for FM mode	19A
Hang time for S-meter squelch	19B
Mic gain for FM	41
Sub-tone mode for FM	42
TX hold: 1750 Hz tone	44
<b>FSK</b>	
FSK keying polarity	39
FSK shift	38
FSK tone frequency	40
<b>LCD</b>	
Display brightness	00
Key illumination	01
RC-2000 panel/ TS-2000(X) dot-matrix display contrast	59
<b>MEMORY FUNCTION</b>	
Memory-VFO split operation	06A
Tunable (ON) or fixed (OFF) memory channel frequencies	06B

Function	Menu No.
MESSAGE PLAYBACK	
Interval time for repeating the playback	29B
Repeat the playback	29A
PF KEYS	
Front panel PF key	51A
Microphone PF1 (CALL) key	51B
Microphone PF2 (VFO) key	51C
Microphone PF3 (MR) key	51D
Microphone PF4 (PF) key	51E
POWER CONTROL	
Fine transmit power tuning	23
POWER ON/ OFF	
APO (Auto Power Off) function	57
REMOTE CONTROL	
Enable Mic remote control	45D
Display mode for RC-2000	60
RC-2000 font in easy operation mode	58
RC-2000 panel/ TS-2000(X) dot-matrix display contrast	59
REPEATER	
Acknowledgement signal in external remote control mode	61D
External remote control	61E
Remote control ID code	61C
Repeater mode select	61A
Repeater TX hold	61B
SCAN	
Program scan hold	09
Program scan partially slowed	07
Slow down frequency range for the Program scan	08
Scan resume method	10
Visual scan range	11
SKY COMMAND II+	
Commander callsign for Sky Command II+	62A
Sky Command II+ communication speed	62D
Sky Command II+ mode	62E
Sky Command II+ tone frequency	62C
Transporter callsign for Sky Command II+	62B
SPEAKER	
Audio output configuration for EXT.SP2 or headphone	16
Reverses the EXT.SP1 and EXT.SP2 (the headphone jack L/R channels) audio outputs	17

Function	Menu No.
TNC	
AF input level for Packet	50B
COM port communication speed	56
Data transfer speed: External TNC	50F
Data transfer speed: Internal TNC	47
DCD sensing band	48
Main band AF output level for packet operation	50C
MAIN/ SUB band: External TNC	50E
MAIN/ SUB band: Internal TNC	46
Packet communication mode	55
Packet filter bandwidth	50A
Packet Cluster RX confirmation tone	49B
Packet Cluster Tune mode	49A
Sub band AF output level for packet operation	50D
TRANSMISSION CONTROL	
Time-out Timer	24
TX inhibit	54
TRANSVERTER	
Transverter frequency display	25
TUNING CONTROL	
Frequency correction for changing SSB to CW	37
9 kHz frequency step size for the <b>MULTI/ CH</b> control in AM mode on the AM broadcast band	05
Rounds off VFO frequencies changed by using the <b>MULTI/ CH</b> control	04
Tuning control change per revolution	02
Tuning with <b>MULTI/ CH</b> control	03
VOLUME CONTROL	
Beep output level	12
DRU-3A playback volume	14
TX sidetone volume	13
VS-3 playback volume	15

## SSB TRANSMISSION

SSB is the most commonly-used mode on the HF Amateur bands. Compared with other voice modes, SSB requires only a narrow bandwidth for communications. SSB also allows long distance communications with minimum transmit power.

If necessary, refer to “OPERATING BASICS”, beginning on page 18, for details on how to receive.

- 1 Select an operating frequency.
- 2 Press **[LSB/ USB/ AUTO]** to select either lower or upper sideband mode.
  - “LSB” or “USB” appears to show which sideband is selected.



- 3 Press **[MIC/ CAR]** to activate the Microphone Gain Adjust.
  - The current gain level appears.



- 4 Press **[SEND]**, or press and hold Mic **[PTT]**.
  - The **MAIN** band LED lights red.
  - Refer to “VOX” {page 39} for information on automatic TX/RX switching.
- 5 Speak into the microphone and adjust the **MULTI/ CH** control so that the ALC meter reflects your voice level but does not exceed the ALC limit.
  - Speak in your normal tone and level of voice. Speaking too close to the microphone or too loudly may increase distortion and reduce intelligibility at the receiving end.
  - You may want to use the Speech Processor. Refer to “SPEECH PROCESSOR” {page 40} for details.
- 6 Press **[SEND]** or release Mic **[PTT]** to return to receive mode.
  - The **MAIN** band LED lights green or turns off, depending on the MAIN SQL setting.
- 7 Press **[MIC/ CAR]** to quit the Microphone Gain Adjust.

Refer to “COMMUNICATING AIDS”, beginning on page 37, for information on additional useful operation functions.

## FM TRANSMISSION

FM is a common mode for communicating on VHF or UHF frequencies. Many amateur radio operators use their portable radios and mobile transceivers in FM mode. You can also utilize repeaters to reach your friends when they are outside your antenna coverage. Although FM requires a wider bandwidth when compared to SSB or AM mode, it has the finest audio quality among these modes. When combined with the full-quieting aspect of FM signals, which suppress background noise on the frequency, FM can be the best method for maintaining regular schedules with your local friends.

If necessary, refer to “OPERATING BASICS”, beginning on page 18, for details on how to receive.

- 1 Select an operating frequency.
- 2 Press **[FM/ AM/ NAR]** to select FM mode.
  - “FM” appears.



- 3 Press **[SEND]**, or press and hold Mic **[PTT]**.
  - The **MAIN** band LED lights red.
  - Refer to “VOX” {page 39} for information on automatic TX/RX switching.
- 4 Speak into the microphone in your normal tone and level of voice.
  - Speaking too close to the microphone or too loudly may increase distortion and reduce intelligibility at the receiving end.
  - You can switch the Microphone Gain for FM between “LOW”, “MID”, and “HIGH” by using Menu No. 41. “LOW” is usually appropriate; however, select high if other stations report that your modulation is weak. The **MULTI/ CH** control has no effect in FM mode.
- 5 Press **[SEND]** or release Mic **[PTT]** to return to receive mode.
  - The **MAIN** band LED lights green or turns off, depending on the MAIN SQL setting.

Refer to “COMMUNICATING AIDS”, beginning on page 37, for additional information on useful operation functions.

**Note:** Microphone gain adjustment for SSB or AM has no effect in FM mode. In FM mode, you must select “LOW”, “MID” or “HIGH” in Menu No. 41.

## AM TRANSMISSION

Each mode used on the HF Amateur bands has its own advantages. Although long distance DX contacts may be less common while using AM, the superior audio quality characteristic of AM operation is one reason why some hams prefer this mode.

When looking for others operating on AM, check the following frequencies first:

3885 kHz, 7290 kHz, 14286 kHz, 21390 kHz, and 29000 ~ 29200 kHz

If necessary, refer to “OPERATING BASICS”, beginning on page 18, for details on how to receive.

- 1 Select an operating frequency.
- 2 Press **[FM/ AM/ NAR]** to select AM mode.
  - “AM” appears.



- 3 Press **[MIC/ CAR]** to activate the Microphone Gain Adjust.
  - The current gain level appears.
- 4 Press **[SEND]**, or press and hold Mic **[PTT]**.
  - The **MAIN** band LED lights red.
  - Refer to “VOX” {page 39} for information on automatic TX/RX switching.
- 5 Speak into the microphone and adjust the **MULTI/ CH** control so that the calibrated power meter slightly reflects your voice level.
  - Speak in your normal tone and level of voice. Speaking too close to the microphone or too loudly may increase distortion and reduce intelligibility at the receiving end.
  - You may want to use the Speech Processor. Refer to “SPEECH PROCESSOR” {page 40} for details.
- 6 Press **[SEND]** or release Mic **[PTT]** to return to receive mode.
  - The **MAIN** band LED lights green or turns off, depending on the MAIN SQL setting.
- 7 Press **[MIC/ CAR]** to quit the Microphone Gain Adjust.

Refer to “COMMUNICATING AIDS”, beginning on page 37, for information on additional useful operation functions.

**Note:** If necessary, adjust the carrier level before speaking into the microphone. Press **[FUNC]**, **[MIC/ CAR]** to enter the adjustment mode. While transmitting only carrier signals, turn the **MULTI/ CH** control so that the ALC meter just begins to indicate. Press **[FUNC]**, **[MIC/ CAR]** again to complete the adjustment.

## NARROW BANDWIDTH FOR FM

When operating in FM mode, you can select wide or narrow bandwidth operation. The table below shows the RX IF filter bandwidth and TX deviation combination for each operating mode. The bandwidth selection is crucial to avoid audio distortion or insufficient intelligibility that the other station will encounter.

Mode	RX IF Filter	TX Deviation
FM	Wide	Wide
FMN	Narrow <sup>1</sup>	Narrow

<sup>1</sup> K-type: Main transceiver only.

All E-types: Main transceiver and sub-receiver.

- 1 Press **[FM/ AM/ NAR]** to select FM mode.
- 2 Press **[FUNC]**, **[FM/ AM/ NAR]** to toggle the selection between Wide and Narrow.
  - “FM” or “FMN” appears to indicate which bandwidth is selected.



## NARROW BANDWIDTH FOR AM

When receiving AM on the main transceiver, you can further decrease the bandwidth to eliminate interference. However, the TX deviation of AM is not affected by this selection.

- 1 Press **[FM/ AM/ NAR]** to select AM mode on the main transceiver.
- 2 Press **[FUNC]**, **[FM/ AM/ NAR]** to toggle the selection between Normal and Narrow.
  - “AM” or “AMN” appears to indicate which IF bandwidth is selected for the main transceiver.

## 7 BASIC COMMUNICATIONS

### CW TRANSMISSION

CW operators know that this mode is very reliable when communicating under worst conditions. It may be true that newer digital modes rival CW as being equally as useful in poor conditions. These modes, however, do not have the long history of service nor the simplicity that CW provides.

This transceiver has a built-in electronic keyer that supports a variety of functions. For details on using these functions, refer to “ELECTRONIC KEYS” {page 42}.

If necessary, refer to “OPERATING BASICS”, beginning on page 18, for details on how to receive.

- 1 Select the operating frequency.
- 2 Press **[CW/ FSK/ REV]** to select CW mode.
  - “CW” appears.



- To precisely tune in another station, use Auto Zero-beat. Refer to “AUTO ZERO-BEAT” {below}.
- 3 Press **[SEND]**.
    - The **MAIN** band LED lights red.
    - Refer to “CW BREAK-IN” {page 42} for information on automatic TX/ RX switching.
  - 4 Begin sending.
    - As you transmit, you should hear a sidetone that lets you monitor your own transmission. Refer to “TX SIDETONE/ RX PITCH FREQUENCY” {below}.
  - 5 Press **[SEND]** to return to receive mode.
    - The **MAIN** band LED lights green or turns off, depending on the MAIN SQL setting.

**Note:** You may adjust the carrier level when necessary. Press **[FUNC]**, **[MIC/ CAR]** to enter the adjustment mode. With the key down, turn the **MULTI/ CH** control so that the ALC meter reads within the ALC zone but does not exceed the upper ALC zone limit. Press **[FUNC]**, **[MIC/ CAR]** again to complete the adjustment.

### AUTO ZERO-BEAT

Use Auto Zero-beat before transmitting to tune in a CW station. Auto Zero-beat automatically and exactly matches your transmit frequency with the station you are receiving. Neglecting to do this will reduce your chances of being heard by the other station.

- 1 Press **[FUNC]**, **[RIT/ CW TUNE]** to start Auto Zero-beat.
  - “CW TUNE” appears.

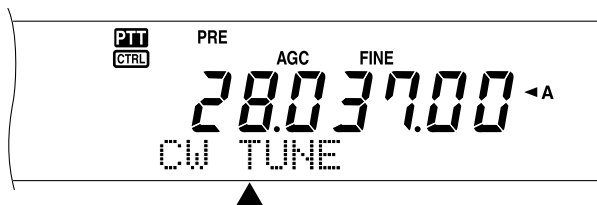

- Your transmit frequency automatically changes so that the pitch of the received signal exactly matches the TX sidetone/ RX pitch frequency that you have selected. Refer to “TX SIDETONE/ RX PITCH FREQUENCY” {below}.
  - When matching is completed, “CW TUNE” disappears.
  - If matching is unsuccessful, the previous frequency is restored.
- 2 To quit Auto Zero-beat, press **[FUNC]**, **[RIT/ CW TUNE]** or **[CLR]**.

#### Note:

- ◆ You cannot start Auto Zero-beat if you have selected 1.0 kHz or wider for the DSP filter bandwidth.
- ◆ When using Auto Zero-beat, the matching error is within  $\pm 50$  Hz in most cases.
- ◆ Auto Zero-beat may fail if the keying speed of the target station is too slow or when some interference is present.
- ◆ When RIT function is ON, only RIT frequencies change to make the Auto Zero-beat adjustment.

### TX SIDETONE/ RX PITCH FREQUENCY

As you send CW, you will hear tones from the transceiver speaker. These are called transmit (TX) sidetones. Listening to these tones, you can monitor what you are transmitting. You may also use the tones to ensure that your key contacts are closing, the keyer is functioning, or to practice sending without actually putting a signal on the air.

Receive pitch refers to the frequency of CW that you hear after tuning in a CW station.

On this transceiver, the frequency of the sidetone and receive pitch are equal and selectable. Access Menu No. 31 to select the frequency that is most comfortable for you. The selectable range is from 400 Hz to 1000 Hz in steps of 50 Hz.

To change the volume of the TX sidetone, access Menu No. 13. The selections range from 1 to 9 and OFF.

**Note:** The position of the **MAIN AF** and **SUB AF** controls do not affect the volume of the TX sidetone.



## SPLIT-FREQUENCY OPERATION

Usually you can communicate with other stations using a single frequency for receiving and transmitting. In this case, you select only one frequency on either VFO A or VFO B. However, there are cases where you must select one frequency for receiving and a different frequency for transmitting. This requires the use of two VFOs. This is referred to as “split-frequency operation”. One typical case which requires this type of operation is when you use an FM repeater {page 32}. Another typical case is when you call a rare DX station.

When a rare or desirable DX station is heard, that operator may immediately get many simultaneous responses. Often, such a station is lost under the noise and confusion of many calling stations. If you find that you are suddenly being called by many operators, it is your responsibility to control the situation. You may announce that you will be “listening up 5 (kHz, from your present transmit frequency)”, or “listening down between 5 and 10 (kHz)”.

- 1 Press **[MAIN]**, **[A/B]** to select VFO A or VFO B on the main transceiver.
  - “◀A” or “◀B” appears to show which VFO is selected.
- 2 Select an operating frequency.
  - The frequency selected at this point will be used for transmitting.
  - To copy the selected VFO frequency to the other VFO, press **[A=B]**.
- 3 Press **[A/B]** to select the other VFO.
- 4 Select an operating frequency.
  - The frequency selected on this VFO will be used for receiving.
- 5 Press **[SPLIT]**.
  - “SPLIT” appears.



- Each press of **[A/B]** reverses the receive and transmit frequencies.
- 6 To quit split-frequency operation, press **[SPLIT]** again.
    - “SPLIT” disappears.

If you access Menu No. 06A and select “ON”, you can recall a memory channel to use for either receiving or transmitting. For more information, refer to “Memory-VFO Split Operation” {page 60} under “MEMORY FEATURES”.

**Note:** You cannot perform SPLIT operation on the sub-receiver; it has only one VFO.

## TF-SET (TRANSMIT FREQUENCY SET)

TF-SET allows you to temporarily switch your transmit frequency and receive frequency. Canceling this function immediately restores the original transmit and receive frequencies. By activating TF-SET, you can listen on your transmit frequency, and change it while listening. This allows you to check whether or not the newly selected transmit frequency is free of interference.

- 1 Configure split-frequency operation as explained in the previous section.
- 2 Press and hold **[TF-SET]**.
- 3 While holding down **[TF-SET]**, change the operating frequency by turning the **Tuning** control or by pressing Mic **[UP]/ [DWN]**.
  - The transceiver receives on the frequency that you select, but the frequency shown on the sub-display stays unchanged.
- 4 Release **[TF-SET]**.
  - You are now receiving again on your original receive frequency.

Successfully contacting a DX station in a pileup often depends on making a well-timed call on a clear frequency. That is, it is important to select a relatively clear transmit frequency and to transmit at the exact instant when the DX station is listening but the majority of the groups aren't transmitting. Switch your receive and transmit frequencies by using TF-SET and listen. You will soon learn the rhythm of the DX station and the pileup. The more proficient you become at using this function, the more DX stations you will contact.

### Note:

- ◆ If you press **[FUNC]**, **[ATT/ F LOCK]** to lock the operating frequency before using TF-SET, pressing an incorrect button by mistake retains the original receive frequency.
- ◆ TF-SET is disabled while transmitting.
- ◆ If you have recalled a memory channel (excluding CH 290 to 299), you cannot change the recalled frequency using the **Tuning** control.
- ◆ To enable the **Tuning** control, access Menu No. 06B and select “ON”. Pressing Mic **[UP]/[DWN]** after recalling a memory channel changes the memory channels.
- ◆ An RIT frequency shift is not added; however, an XIT frequency shift is added to the transmit frequency.

## 8 ENHANCED COMMUNICATIONS

### FM REPEATER OPERATION

When using FM mode, you may access a repeater to enjoy long distance communications. Repeaters, which are often installed and maintained by radio clubs, are usually located on mountain tops or other elevated locations. Generally they operate at higher ERP (Effective Radiated Power) than a typical station. This combination of elevation and high ERP allows communications in FM over much greater distances than FM communications without using repeaters.

Most repeaters use a receive and transmit frequency pair with an offset. In addition, some repeaters must receive a tone from the transceiver before it allows access. Repeaters are available on the 29, 50, 144, 430/ 440 MHz, and 1.2 GHz bands (TS-2000/ TS-B2000 Optional). For further information, including repeater frequencies, consult your local repeater reference.

This transceiver provides the following three methods for programming two separate frequencies:

- Using the Split-Frequency function {page 31}
- Programming an offset (29, 50, 144, 430/ 440 MHz and 1.2 GHz bands)
- Storing in a Split-Frequency channel {page 59}

**Note:**

- ◆ When programming two separate frequencies using two VFOs, be sure to select FM mode on both VFOs.
- ◆ When operating through a repeater, over deviation caused by speaking too loudly into the microphone can cause your signal to "talk-off" (break up) through the repeater.

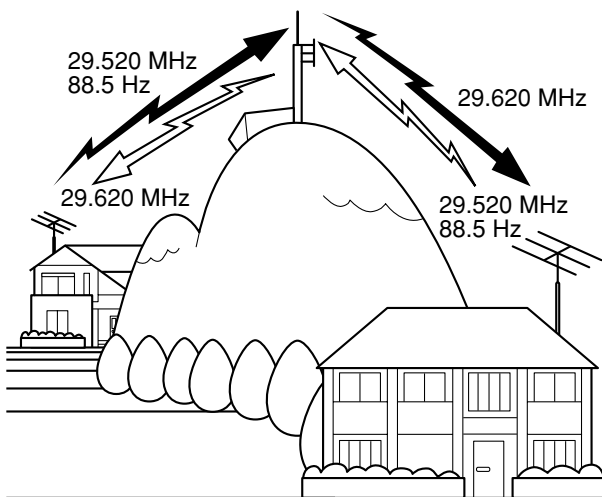

### PROGRAMMING AN OFFSET

When using the 29, 50, 144, 430/ 440 MHz or 1.2 GHz band (TS-2000/ TS-B2000 Optional), selecting a single frequency and an offset is another method for programming two separate frequencies. Unlike the Split-Frequency function, this method requires only a single VFO.

**Note:** If you store offset settings in a memory channel, you need not reprogram each time. Refer to "MEMORY FEATURES" {page 58}.

### ■ Selecting an Offset Direction

- 1 Select a receive frequency.
- 2 Press **[0/ SHIFT/OFFSET]** to switch the offset direction.
  - Select whether the transmit frequency will be higher (+) or lower (–) than the receive frequency.
  - "+" or "–" appears to indicate which offset direction is selected.



- To program the –7.6 MHz (430 MHz) or –6.0 MHz (1.2 GHz) offset on all E-types, repeatedly press **[0/ SHIFT/OFFSET]** until "=" appears.

If the offset transmit frequency falls outside the allowable range, transmitting is inhibited. Use one of the following methods to bring the transmit frequency within the band limits:

- Move the receive frequency further inside the band.
- Change the offset direction.

**Note:**

- ◆ You can only change the offset direction while in FM mode.
- ◆ While using an odd-split memory channel for transmitting, you cannot change the offset direction.

### ■ Selecting an Offset Frequency

To access a repeater which requires an odd-split frequency pair, change the offset frequency from the default which is used by most repeaters. The default offset frequencies are as follows.

Band	K-type	All E-types
144 MHz	±600 kHz	
430/ 440 MHz	±5.0 MHz	±1.6 MHz –7.6 MHz
1.2 GHz	±12.0 MHz	±35.0 MHz –6.0 MHz

As for the 29 and 50 MHz bands, the default offset is set to 0 MHz (Simplex). Program the desired offset frequency for these bands.

- 1 Press **[FUNC]**, **[0/ SHIFT/OFFSET]**.
- 2 Turn the **MULTI/ CH** control to select the appropriate offset frequency.
  - The selectable range is from 0.00 MHz to 59.95 MHz in steps of 50 kHz.
- 3 Press **[FUNC]**, **[0/ SHIFT/OFFSET]** again to complete the setting.

**All E-types only:** If you have selected "=" for the offset direction, you cannot change the default (–7.6 MHz or –6.0 MHz).

**TRANSMITTING A TONE**

Some FM repeaters require the transceiver to transmit a sub-audible tone to prevent other repeaters on the same frequency from locking each other up. The required tone frequency differs among repeaters. Repeater also differ in their requirements for either continuous or burst tones. For the appropriate selections for your accessible repeaters, consult your local repeater reference.

After completing the tone settings, pressing **[SEND]** or pressing and holding Mic **[PTT]** causes the transceiver to transmit the selected tone. If you have selected a 1750 Hz tone, press **[4/ TONE/SEL]** to transmit the tone without pressing Mic **[PTT]**.

*Note: If you store tone settings in a memory channel, you need not reprogram each time. Refer to "MEMORY FEATURES" (page 58).*

■ **Activating the Tone Function**

- 1 Confirm that FM mode has been selected on the VFO(s).
  - When using two VFOs, you must select FM mode on both VFOs.
- 2 Press **[4/ TONE/SEL]** to switch the Tone function ON (or OFF).
  - "T" appears when the function is ON.



- Note:*
- ◆ You cannot use the Tone function with the CTCSS or DCS functions.
  - ◆ You need to activate the Tone function only when selecting one of the 38 standard frequencies. The selection you make here will not affect the transmission of the 1750 Hz tone.

■ **Selecting a Tone Frequency**

- 1 Press **[FUNC]**, **[4/ TONE/SEL]**.
  - The current tone frequency appears. The default is 88.5 Hz.



- 2 Turn the **MULTI/ CH** control to select the appropriate tone frequency.
  - The available tone frequencies are listed in the following table.
- 3 Press **[FUNC]**, **[4/ TONE/SEL]** to complete the setting.

No.	Freq. (Hz)	No.	Freq. (Hz)	No.	Freq. (Hz)	No.	Freq. (Hz)
01	67.0	11	97.4	21	136.5	31	192.8
02	71.9	12	100.0	22	141.3	32	203.5
03	74.4	13	103.5	23	146.2	33	210.7
04	77.0	14	107.2	24	151.4	34	218.1
05	79.7	15	110.9	25	156.7	35	225.7
06	82.5	16	114.8	26	162.2	36	233.6
07	85.4	17	118.8	27	167.9	37	241.8
08	88.5	18	123.0	28	173.8	38	250.3
09	91.5	19	127.3	29	179.9	39	1750
10	94.8	20	131.8	30	186.2		

- Note:*
- ◆ Use Nos. 01 to 39 shown in the table above when selecting tone frequencies via Wireless Remote Control (page 82).
  - ◆ You can select a tone frequency independent of a CTCSS frequency.

■ **Selecting Continuous or Burst**

Access Menu No. 42 to select "Continuous" or "Burst". With Continuous selected, the transceiver sends the tone continuously during the transmission. With Burst selected, the transceiver sends a 500 ms tone each time transmission starts. When using the 144, 430/ 440 MHz, or 1.2 GHz band, continuous tones are always transmitted, regardless of the selection.

■ **Transmitting a 1750 Hz Tone**

Most repeaters in Europe require transceivers to transmit a 1750 Hz tone. With 1750 Hz tone selected, pressing **[4/ TONE/SEL]** causes the transceiver to transmit the 1750 Hz tone. Releasing the key ceases transmission of the code. Some repeaters in Europe must receive continuous signals for a certain period of time, following a 1750 Hz tone. This transceiver is capable of remaining in transmit mode for 2 seconds after transmitting the 1750 Hz tone. Access Menu No. 44 and select "ON".

## 8 ENHANCED COMMUNICATIONS

### AUTOMATIC REPEATER OFFSET

This function automatically selects an offset direction, according to the frequency that you select on the 144 MHz band. The transceiver is programmed for offset directions as shown below. To obtain an up-to-date band plan for repeater offset direction, contact your national Amateur Radio association.

Access Menu No. 43 and switch the function ON or OFF. The default is ON.

#### K-type (U.S.A. and Canada versions)

This complies with the standard ARRL band plan.

144.0 145.5 146.4 147.0 147.6  
145.1 146.0 146.6 147.4 148.0 MHz

S	-	S	+	S	-	+	S	-
---	---	---	---	---	---	---	---	---

S: Simplex

#### All E-types (European versions)

144.0 145.6 145.8 146.0 MHz

S	-	S
---	---	---

S: Simplex

#### Note:

- ◆ Automatic Repeater Offset does not function when Reverse is ON. However, pressing [TF-SET] after Automatic Repeater Offset has selected an offset (split) status, exchanges the receive and transmit frequencies.
- ◆ If you change the offset direction by pressing [0/SHIFT/OFFSET] when Automatic Repeater Offset is ON, the Shift direction on the above figure is applied when you change the frequencies.

### REVERSE FUNCTION

After programming an offset on the 29, 50, 144, 430/ 440 MHz, and 1.2 GHz (Optional) band, the reverse function exchanges a separate receive and transmit frequency. So, while using a repeater, you can manually check the strength of a signal that you receive directly from the other station. If the station's signal is strong, both stations should move to a simplex frequency to free up the repeater.

Press [TF-SET] to switch the Reverse function ON (or OFF) while the Shift function is active.

- "R" appears when the Reverse function is ON.

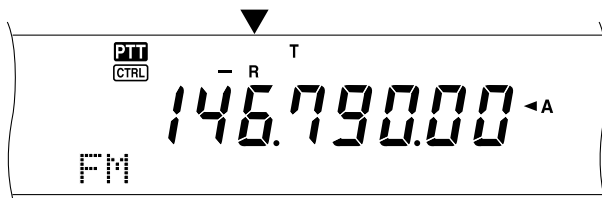

#### Note:

- ◆ If you press [TF-SET] and try to receive outside the available receive frequency, the transceiver will not allow you to tune the frequency. The Reverse function will not operate.
- ◆ Automatic Repeater Offset does not function while Reverse is ON.
- ◆ You cannot switch Reverse ON or OFF while transmitting.

### AUTOMATIC SIMPLEX CHECK (ASC)

ASC functions only when you have programmed an offset on the 29, 50, 144, 430/ 440 MHz or 1.2 GHz (Optional) band. While using a repeater, ASC periodically monitors the strength of a signal that you receive directly from the other station. If the station's signal is strong enough to allow direct contact without a repeater, the ASC indicator on the display starts to blink.

Press and hold [TF-SET] for approximately 1 second to switch the function ON.

- The "[R]" indicator appears when the function is ON.

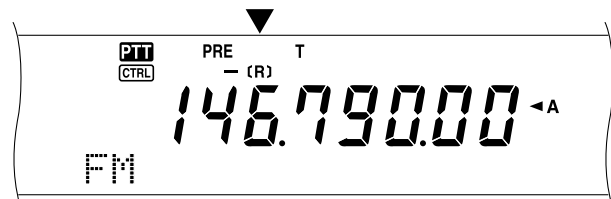

- When direct contact is possible, the "[R]" indicator blinks.
- To quit the function, press [TF-SET].

#### Note:

- ◆ Pressing Mic [PTT] causes the ASC indicator to stop blinking.
- ◆ ASC does not function if your transmit and receive frequencies are the same (simplex operation).
- ◆ ASC does not function while scanning.
- ◆ Activating ASC while using Reverse switches Reverse OFF.
- ◆ If you recall a memory channel or the Call channel that has the Reverse status ON, ASC is switched OFF.
- ◆ ASC causes received audio to be momentarily intermitted every 3 seconds.

### TONE FREQ. ID SCAN

This function scans through all tone frequencies to identify the incoming tone frequency on a received signal. You can use this function to find which tone frequency is required by your local repeater.

- 1 Press [FUNC], [4/ TONE/SEL].

- The current tone frequency appears.

- 2 Press [SCAN/ SG.SEL] to activate the Tone Freq. ID.

- "T" blinks and every Tone frequency is scanned. When the Tone frequency is identified, the transceiver stops scanning and the identified frequency is displayed.



- Press [SCAN/ SG.SEL] again to resume scanning.
- Press [SCAN/ SG.SEL] to stop scanning while the Tone frequency ID scan is active.

## FM CTCSS OPERATION

You may sometimes want to hear calls only from specific persons. When using FM mode, the Continuous Tone Coded Squelch System (CTCSS) allows you to ignore (not hear) unwanted calls from other persons who are using the same frequency. A CTCSS tone is sub-audible and is selectable from among the 38 standard tone frequencies. Select the same CTCSS tone as the other stations in your group. You will not hear calls from stations other than those using the same CTCSS tone.

**Note:** CTCSS does not cause your conversation to be private. It only relieves you from listening to unwanted conversations.

- 1 Press **[A/B]** to select VFO A or VFO B.
  - “◀A” or “◀B” appears to show which VFO is selected.
- 2 Select a band.
- 3 Select an operating frequency.
- 4 Press **[FM/ AM/ NAR]** to select FM mode.
  - “FM” appears.
- 5 Turn the **SQL** control to adjust the squelch.
- 6 Press **[6/ CTCSS/SEL]** to switch the CTCSS function ON (or OFF).
  - “C T” appears when the function is ON.

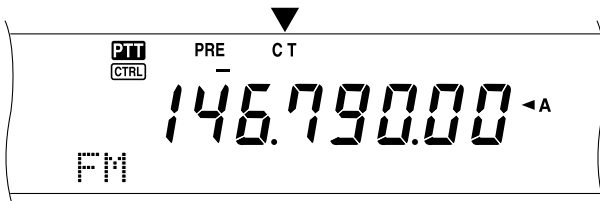

- 7 Press **[FUNC], [6/ CTCSS/SEL]**.
  - The current CTCSS frequency appears. The default CTCSS frequency is 88.5 Hz.



- 8 Turn the **MULTI/ CH** control to select the appropriate CTCSS frequency.
  - The selectable CTCSS frequencies are listed in the following table.
- 9 Press **[FUNC], [6/ CTCSS/SEL]** to complete the setting.

No.	Freq. (Hz)	No.	Freq. (Hz)	No.	Freq. (Hz)	No.	Freq. (Hz)
01	67.0	11	97.4	21	136.5	31	192.8
02	71.9	12	100.0	22	141.3	32	203.5
03	74.4	13	103.5	23	146.2	33	210.7
04	77.0	14	107.2	24	151.4	34	218.1
05	79.7	15	110.9	25	156.7	35	225.7
06	82.5	16	114.8	26	162.2	36	233.6
07	85.4	17	118.8	27	167.9	37	241.8
08	88.5	18	123.0	28	173.8	38	250.3
09	91.5	19	127.3	29	179.9		
10	94.8	20	131.8	30	186.2		

You will hear calls only when the selected tone is received. To answer the call, press **[SEND]** or press and hold Mic **[PTT]**, then speak into the microphone.

Skip steps 7 and 8 if you have already programmed the appropriate CTCSS frequency.

**Note:**

- ◆ When using split-frequency operation, select FM mode on both VFOs to use CTCSS.
- ◆ Use Nos. 01 to 38 shown in the table above when selecting CTCSS frequencies via Wireless Remote Control (page 82).
- ◆ You can select a CTCSS frequency independent of a tone frequency.
- ◆ You cannot use the CTCSS function with the Tone or DCS functions.

## CTCSS FREQ. ID SCAN

This function scans through all CTCSS frequencies to identify the incoming CTCSS frequency on a received signal. You may find this useful when you cannot recall the CTCSS frequency that the other persons in your group are using.

- 1 Press **[FUNC], [6/ CTCSS/SEL]**.
  - The current CTCSS frequency appears.
- 2 Press **[SCAN/ SG.SEL]** to activate the CTCSS Freq. ID scan.
  - “C T” blinks and every CTCSS tone frequency is scanned. When the CTCSS frequency is identified, the transceiver stops scanning and the identified frequency is displayed.

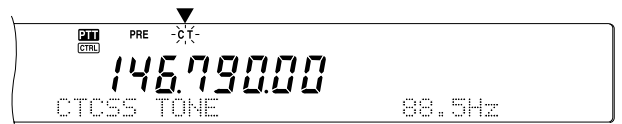

- Press **[SCAN/ SG.SEL]** again to resume scanning.
- Press **[SCAN/ SG.SEL]** to stop scanning while the CTCSS tone frequency ID scan is active.

**Note:** Received signals are audible while scanning is in progress.

## 8 ENHANCED COMMUNICATIONS

### FM DCS OPERATION

Digital Code Squelch (DCS) is another FM application which allows you to ignore (not hear) unwanted calls. It functions the same way as CTCSS. The only differences are the encode/ decode method and the number of selectable codes. For DCS, you can select from 104 different codes listed in the table below.

- 1 Press **[A/B]** to select VFO A or VFO B.
  - “◀A” or “◀B” appears to show which VFO is selected.
- 2 Select a band.
- 3 Select an operating frequency.
- 4 Press **[FM/ AM/ NAR]** to select FM mode.
  - “FM” appears.
- 5 Turn the **SQL** control to adjust the squelch.
- 6 Press **[\*/ DCS/SEL]** to switch the DCS function ON (or OFF).
  - “DCS” appears when the function is ON.

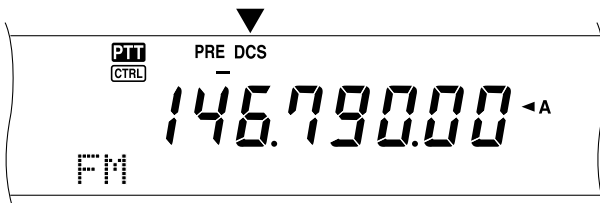

- 7 Press **[FUNC], [\*/ DCS/SEL]**.
  - The current DCS code appears. The default is 023.



- 8 Turn the **MULTI/ CH** control to select the appropriate DCS code.
  - The available DCS codes are listed in the following table.

023	065	132	205	255	331	413	465	612	731
025	071	134	212	261	332	423	466	624	732
026	072	143	223	263	343	431	503	627	734
031	073	145	225	265	346	432	506	631	743
032	074	152	226	266	351	445	516	632	754
036	114	155	243	271	356	446	523	654	
043	115	156	244	274	364	452	526	662	
047	116	162	245	306	365	454	532	664	
051	122	165	246	311	371	455	546	703	
053	125	172	251	315	411	462	565	712	
054	131	174	252	325	412	464	606	723	

- 9 Press **[FUNC], [\*/ DCS/SEL]** again to complete the setting.

You will hear calls only when the selected code is received. To answer the call, press **[SEND]** or press and hold Mic **[PTT]**, then speak into the microphone.

Skip steps 7 to 9 if you have already programmed the appropriate DCS code.

**Note:** You cannot use DCS with the Tone or CTCSS functions.

### DCS CODE ID SCAN

This function scans through all DCS codes to identify the incoming DCS code on a received signal. You may find this useful when you cannot recall the DCS code that the other persons in your group are using.

- 1 Press **[FUNC], [\*/ DCS/SEL]**.
  - The current DCS code appears.
- 2 Press **[SCAN/ SG.SEL]** to activate the DCS Code ID scan.
  - “DCS” blinks and every DCS code is scanned. When the DCS code is identified, the transceiver stops scanning and the identified DCS ID is displayed.



- Press **[SCAN/ SG.SEL]** to resume scanning.
- Press **[SCAN/ SG.SEL]** to stop scanning while the DCS code ID scan is active.

**Note:** Received signals are audible while scanning is in progress.

## RECEIVING

### SELECTING YOUR FREQUENCY

In addition to turning the **Tuning** control or pressing Mic **[UP]/ [DOWN]**, there are several other ways to select your frequency. This section describes additional methods of frequency selection that may save you time and effort.

#### ■ Direct Frequency Entry

When the desired frequency is far removed from the current frequency, directly entering a frequency from the numeric keypad is usually the fastest method.

1 Press **[ENT]**.

- “- - - - -” appears.

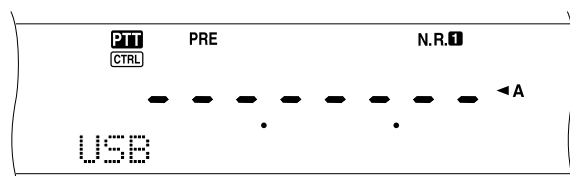

2 Press the numeric keys (**[0]** to **[9]**) to enter your desired frequency.

- Pressing **[ENT]** fills the remaining digits (the digits you did not enter) with 0 and completes the entry.
- To select 1.85 MHz for example, press **[0]**, **[0]**, **[1]**, **[8]**, **[5]**, then press **[ENT]** to complete the input (7 key strokes).
- To shorten the key strokes, you can also use **[.]** as MHz. Press **[1]**, **[.]** (MHz), **[8]**, **[5]**, then press **[ENT]** to complete the input (5 key strokes).
- Pressing **[CLR]** cancels the entry and restores the current VFO frequency.

#### Note:

- ◆ You can enter the frequency in the range of 30.00 kHz to 1299.99999 MHz. Refer to the specifications for the available frequency range.
- ◆ Attempting to enter a frequency that is outside the selectable frequency range causes an alarm to sound. The entered frequency is rejected.
- ◆ When the entered frequency does not meet the current VFO frequency step size requirement, the nearest available frequency is automatically selected (sub-receiver). The nearest available frequency is automatically selected after the entered frequency is changed (main transceiver).
- ◆ When the 10 Hz digit (last displayed digit) is entered, the digit 0 is automatically entered for the 1 Hz digit, and frequency entry is completed. The 1 Hz digit is not displayed.
- ◆ When an entered frequency is accepted, RIT or XIT will be switched OFF, but the RIT or XIT offset frequency is not cleared.
- ◆ After recalling memory channels 290 to 299 that have Start and End frequencies stored, the receive frequency can be changed by using Direct Frequency Entry within the programmed range.

#### ■ Using 1 MHz Steps

Pressing **[+]/ [-]** on the front panel changes Amateur bands. You can also use the **MULTI/ CH** control to change the operating frequency in steps of 1 MHz.

1 Press **[1MHz/ SEL]**.

- “MHz” appears.

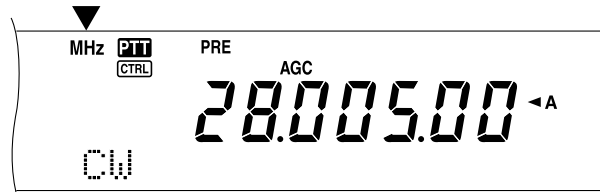

2 Turn the **MULTI/ CH** control.

- Clockwise increases the frequency, counter-clockwise decreases the frequency.

3 Press **[1MHz/ SEL]** to exit the function.

- “MHz” disappears.

If you prefer to change the frequency in steps of 100 kHz or 500 kHz steps rather than 1 MHz, press **[FUNC]**, **[1MHz/ SEL]** then turn the **MULTI/ CH** control to select 100 kHz or 500 kHz.

*Note: Even if 100 kHz or 500 kHz is selected for the **[1MHz/ SEL]** key, the MHz icon appears.*

#### ■ Quick QSY

To move up or down the frequency quickly, use the **MULTI/ CH** control. Turning this control changes the operating frequency in steps of 5 kHz for SSB/ CW/ FSK and 10 kHz for FM/ AM (below 60 MHz).

- If you want to change the default frequency step size, press **[FUNC]**, **[9/ FINE/STEP]**. Select 5 kHz, 6.25 kHz, 10 kHz, 12.5 kHz, 15 kHz, 20 kHz, 25 kHz, 30 kHz, 50 kHz or 100 kHz for FM/ AM, and 1 kHz, 2.5 kHz, 5 kHz, or 10 kHz for the other modes. The default step size is 5 kHz for SSB/ CW/ FSK/ AM and 10 kHz for FM (below 60 MHz).
- When changing the operating frequency by using the **MULTI/ CH** control, frequencies are rounded such that new frequencies are multiples of the frequency step size. To cancel this function, access Menu No. 04 and select “OFF” (default is ON).
- Within the AM broadcast band, the step size automatically defaults to the frequency step value in Menu No. 05. This step size can be switched between 9 kHz (all E-types: ON) and 5 kHz (K-type: OFF) via Menu No. 05.

*Note: The programmed frequency step size for the **MULTI/ CH** control is stored independently for the HF/ 50 MHz, 144 MHz, 430/ 440 MHz and 1.2 GHz bands (main transceiver). You can also set a different frequency step size for SSB, CW, FSK, AM and FM modes. The sub-receiver also stores the independent frequency step size for 118 MHz (K-type only), 144 MHz, 300 MHz (K-type only), and 430/ 440 MHz bands. You can also set a different frequency step size for FM and AM.*

## 9 COMMUNICATING AIDS

### ■ Fine Tuning

The default step value when turning the **Tuning** control to change the frequency is 10 Hz for SSB, CW, and FSK modes, and 100 Hz for FM and AM modes. However, you can change the step size to 1 Hz for SSB, CW, and FSK modes, and 10 Hz for FM and AM modes.

- 1 Press **[9/ FINE/STEP]**.
  - “FINE” appears.

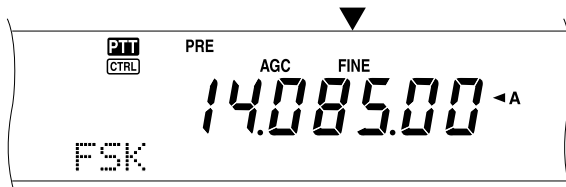

- 2 Turn the **Tuning** control to select the exact frequency.
- 3 To quit the function, press **[9/ FINE/STEP]** again.
  - “FINE” disappears.

**Note:**

- ◆ *Fine Tuning works only on the main transceiver.*
- ◆ *If Menu No. 03 is ON, you cannot perform fine tuning in FM mode for all bands and AM mode for the 144 MHz/ 430/ 440 MHz/ 1.2 GHz (TS-2000 optional) bands.*

### ■ Equalizing VFO Frequencies (A=B)

This function allows you to copy the frequency and modulation mode of the active VFO to the inactive VFO.

- 1 Select the frequency and mode on VFO A or VFO B.
- 2 Press **[A=B]**.
  - The frequency and mode selected in step 1 are copied to the inactive VFO.
- 3 Press **[A/B]** to confirm that the frequency was copied.

### RIT (RECEIVE INCREMENTAL TUNING)

RIT provides the ability to change your receive frequency by  $\pm 20.00$  kHz in steps of 10 Hz without changing your transmit frequency. If the Fine Tuning (**[9/ FINE/STEP]**) function is ON, the step size becomes 1 Hz. RIT works equally well with all modulation modes and while using VFO or Memory Recall mode.

- 1 Press **[RIT/ CW TUNE]**.
  - “RIT” and the RIT offset appear.

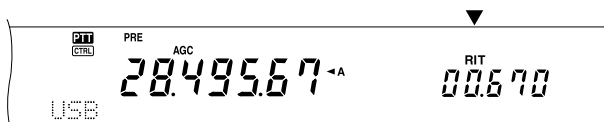

- 2 If required, press **[CLEAR]** to reset the RIT offset to 0.

- 3 Turn the **RIT/ SUB** control to change your receive frequency.
- 4 To turn off RIT, press **[RIT/ CW TUNE]**.
  - The receive frequency is returned to the frequency that was selected prior to step 1.

**Note:**

- ◆ *RIT works only on the main transceiver.*
- ◆ *When storing the frequency in a Memory channel with RIT function ON, RIT offset frequency is added or subtracted to/ from the VFO frequency. Then the calculated data is stored in the Memory channel.*

### AGC (AUTOMATIC GAIN CONTROL)

When using a mode other than FM, AGC selects the time constant for the automatic gain control circuit.

Selecting a slow time constant will cause the receiver gain and S-meter readings to react slowly to large input changes. A fast time constant causes the receiver gain and the S-meter to react quickly to changes in the input signal. A fast AGC setting is particularly useful in the following situations:

- Tuning rapidly
- Receiving weak signals
- Receiving high-speed CW

Unlike other transceivers, the TS-2000's digital AGC circuit allows you to adjust the time constant from slow to fast in 20 steps, where 1 is the slowest and 20 is the fastest. Furthermore, you can switch the AGC OFF if you desire.

For your convenience, the following default AGC time constant has already been programmed.

SSB: Level 7 SLLF CW: Level 12 SLLF  
FSK: Level 14 SLLF AM: Level 5 SLLF

To change the default time constant:

- 1 Press **[8/ AGC/OFF]**.
  - The AGC time constant scale appears on the sub dot-matrix display.
- 2 To select a slower time constant, turn the **MULTI/ CH** control counterclockwise. The bar indicator moves from F(ast) to S(low). To select a faster time constant, turn the **MULTI/ CH** control clockwise. The bar indicator moves from S(low) to F(ast).



- 3 If you want to turn the AGC OFF, press **[FUNC]**, **[8/ AGC/OFF]**.

**Note:** *You cannot adjust the AGC time constant on the sub-receiver.*



## TRANSMITTING

### VOX (VOICE-OPERATED TRANSMIT)

VOX eliminates the necessity of manually switching to the transmit mode each time you want to transmit. The transceiver automatically switches to transmit mode when the VOX circuitry senses that you have begun speaking into the microphone.

When using VOX, develop the habit of pausing between thoughts to allow the transceiver to drop back to receive mode briefly. You will then hear if anybody wants to interrupt, plus you will have a short period to gather your thoughts before speaking again. Your listeners will appreciate your consideration as well as respect your more articulate conversation.

VOX can be switched ON and OFF independently for CW and the other modes, excluding FSK.

Press **[VOX/ LEVEL]** to toggle between VOX ON and OFF.

- The **VOX** LED lights.

### ■ Microphone Input Level

To enjoy the VOX function, take the time to properly adjust the gain of the VOX circuit. This level controls the capability of the VOX circuit to detect the presence or absence of your voice. In CW mode, this level cannot be adjusted.

- 1 Select USB, LSB, FM, or AM mode.
- 2 Press **[VOX/ LEVEL]** to switch the VOX function ON.
  - The **VOX** LED lights.
- 3 Press **[FUNC]**, **[VOX/ LEVEL]**.
  - The current VOX gain appears on the sub dot-matrix display.
- 4 While speaking into the microphone using your normal tone of voice, adjust the setting (default is 4) using the **MULTI/ CH** control until the transceiver reliably switches to transmit mode each time you speak.
  - The selectable gain range is from 0 to 9.
  - The setting should not allow background noise to switch the transceiver to transmit mode.

**Note:** The VOX gain level can be adjusted even if VOX is switched OFF or while you are transmitting.

### ■ Delay Time

If the transceiver returns to receive mode too quickly after you stop speaking, your final word may not be transmitted. To avoid this, select an appropriate delay time that allows all of your words to be transmitted without an overly long delay after you stop speaking.

- 1 Select USB, LSB, FM, or AM mode.
- 2 Press **[VOX/ LEVEL]** to switch the VOX function ON.
- 3 Press **[FUNC]**, **[KEY/ DELAY]**.
  - The current setting appears on the sub dot-matrix display. The default is 50.



- 4 While speaking into the microphone using your normal tone of voice, adjust the **MULTI/ CH** control such that the transceiver switches to receive mode after you have stopped talking.
  - The selectable range is from 5 to 100 (150 ms to 3000 ms) in steps of 5, or OFF.
- 5 Press **[FUNC]**, **[KEY/ DELAY]** to set the VOX delay.

## 9 COMMUNICATING AIDS

### SPEECH PROCESSOR

The Speech Processor levels out large fluctuations in your voice while you speak. When using SSB, FM, or AM mode, this leveling action effectively raises the average transmit output power, resulting in a more understandable signal. The amount of voice compression is fully adjustable. You will notice that using the Speech Processor makes it easier to be heard by distant stations.

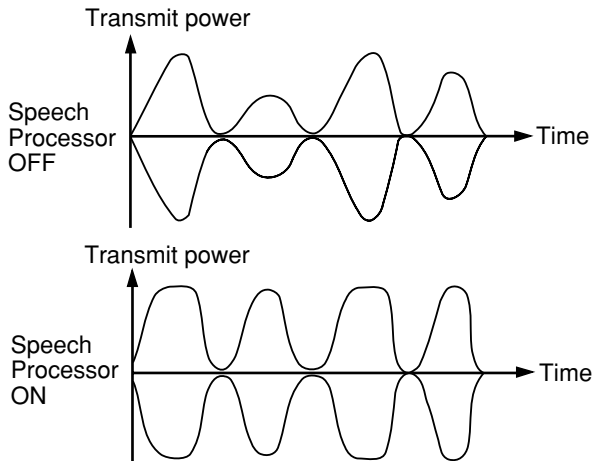

- 1 Select USB, LSB, FM, or AM mode.
- 2 Press **[PROC/ LEVEL]** to switch the Speech Processor ON.
  - The **PROC** LED lights.
- 3 Press **[FUNC]**, **[PROC/ LEVEL]** to enter the Speech Processor input level adjustment mode.
- 4 As you speak into the microphone, turn the **MULTI/ CH** control so that the compression meter indicates that the compression level is around 10 dB while you speak.
  - Using higher compression will not improve your signal clarity or apparent signal strength. Excessively compressed signals are more difficult to understand due to distortion and are less pleasant to hear than signals with less compression.
- 5 Press **[FUNC]**, **[PROC/ LEVEL]** to exit the Speech Processor input level adjustment.
- 6 Press **[MIC/ CAR]** to enter the Speech processor output level Adjustment.
  - As you speak into the microphone, turn the **MULTI/ CH** control so that the ALC meter reflects according to your voice level but does not exceed the ALC limit. Press **[MIC/ CAR]** to exit when you finish the adjustment.

### XIT (TRANSMIT INCREMENTAL TUNING)

Similar to RIT, XIT provides the ability to change your transmit frequency by  $\pm 20.00$  kHz in steps of 10 Hz without changing your receive frequency. If the Fine Tuning function is ON, the step size is 1 Hz.

- 1 Press **[XIT/ ALT]**.
  - “XIT” and the XIT offset appear.

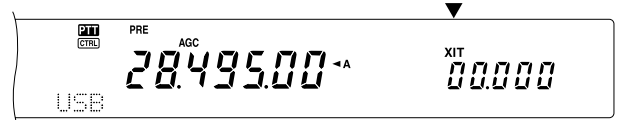

- 2 If required, press **[CLEAR]** to reset the XIT offset to 0.
- 3 Turn the **RIT/ SUB** control to change your transmit frequency.



- 4 To turn XIT OFF, press **[XIT/ ALT]**.
  - The transmit frequency is returned to the frequency that was selected prior to step 1.

#### Note:

- ◆ *XIT works only on the main transceiver.*
- ◆ *The frequency shift set by the **RIT/ SUB** control is also used by the RIT function. Therefore, changing or clearing the XIT offset also affects the RIT offset.*
- ◆ *When the XIT frequency exceeds the limit of available transmission frequency, the transceiver automatically stops transmitting.*

## CUSTOMIZING TRANSMIT SIGNAL CHARACTERISTICS

The quality of your transmitted signal is important, regardless of which on-air activity you pursue. However, it is easy to be casual and overlook this fact since you don't listen to your own signal. The following sub-sections provide information that will help you tailor your transmitted signal.

### ■ TX Filter Bandwidth (SSB/ AM)

Use Menu No. 22 to select one of the following transmit bandwidths: 2.0 kHz, 2.2 kHz, 2.4 kHz (default), 2.6 kHz, 2.8 kHz, or 3.0 kHz.

Bandwidth	Passband frequency
2.0 kHz	500 ~ 2500 Hz
2.2 kHz	400 ~ 2600 Hz
2.4 kHz	300 ~ 2700 Hz
2.6 kHz	200 ~ 2800 Hz
2.8 kHz	100 ~ 2900 Hz <sup>1</sup>
3.0 kHz	10 ~ 3000 Hz <sup>1</sup>

<sup>1</sup> If the Speech Processor is ON, the low-cut filter is set to 200 Hz for 2.8 kHz and 3.0 kHz.

### ■ TX Equalizer (SSB/ FM/ AM)

Use Menu No. 21 to change the transmit frequency characteristics of your signal. You can select from one of six different transmit profiles including the default flat response. Selecting any of the following items from the Menu causes "EQ" to appear on the display.

- **Off (OFF):**  
The default frequency response for SSB, FM, and AM.
- **High boost (H BOOST):**  
Emphasizes higher audio frequencies; effective for a bassy voice.
- **Formant pass (F PASS):**  
Improves clarity by suppressing audio frequencies outside the normal voice frequency range.
- **Bass boost (B BOOST):**  
Emphasizes lower audio frequencies; effective for a voice with more high frequency components.
- **Conventional (CONVEN):**  
Emphasizes by 3 dB frequencies at 600 Hz and higher.
- **User (USER):**  
Reserved for the optional ARCP software. Off is programmed at the factory as a default.

## Frequency Response Curves

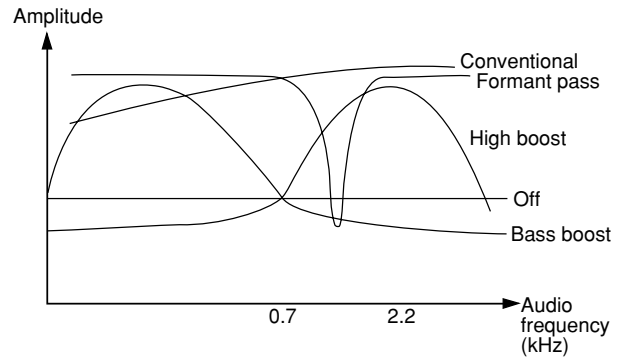

### TRANSMIT INHIBIT

Transmit Inhibit prevents the transceiver from being placed in transmit mode. No signal can be transmitted when this function is ON even if the **PTT** or **[SEND]** is pressed.

- **TX Inhibit OFF:** Transmission is allowed.
- **TX Inhibit ON:** Transmission is not allowed.

Switch the function ON or OFF via Menu No. 54. The default is OFF.

### CHANGING FREQUENCY WHILE TRANSMITTING

Moving your frequency while transmitting is usually an unwise practice due to the risk of interfering with other stations. However, if necessary, by using the **Tuning** control you can change the operating frequency while transmitting. You also can change the XIT offset frequency while in transmit mode.

While transmitting, if you select a frequency outside the transmit frequency range, the transceiver is automatically forced to receive mode. If you selected transmit mode by pressing **[SEND]**, transmission will not resume until you select a frequency inside the transmit frequency range, at which time you must press **[SEND]** again.

## 9 COMMUNICATING AIDS

### CW BREAK-IN

Break-in allows you to transmit CW without manually switching between transmit and receive modes. Two types of Break-ins are available: Semi Break-in and Full Break-in.

#### Semi Break-in:

When the key contacts open, the transceiver automatically waits for the passage of the time period that you have selected. The transceiver then returns to receive mode.

#### Full Break-in:

As soon as the key contacts open, the transceiver returns to receive mode.

### USING SEMI BREAK-IN OR FULL BREAK-IN

- 1 Press **[CW/ FSK/ REV]** to select CW mode.
  - “CW” appears.
- 2 Press **[VOX/ LEVEL]**.
  - The **VOX** LED lights.
- 3 Press **[FUNC]**, **[KEY/ DELAY]**.
  - The current setting (Full or delay time) appears. The default is Full Break-in.



- 4 Turn the **MULTI/ CH** control to select Full Break-in or a delay time for Semi Break-in.
  - Delay time ranges from 5 to 100 (50 ms to 1000 ms) in steps of 5.
- 5 Begin sending.
  - The transceiver automatically switches to transmit mode.
  - **When FBK (Full Break-in) is selected:** The transceiver immediately switches to receive mode when the key opens.
  - **When a delay time is selected:** The transceiver switches to receive mode after the delay time that you have selected has passed.
- 6 Press **[FUNC]**, **[KEY/ DELAY]** again.

**Note:** Full Break-in cannot be used with the TL-922/922A linear amplifier.

### ELECTRONIC KEYS

This transceiver has a built-in electronic keyer that can be used by connecting a keyer paddle to the transceiver's rear panel. Refer to “Keys for CW (PADDLE and KEY)” {page 3} for details regarding this connection. The built-in keyer supports lmbic operation.

### CHANGING KEYING SPEED

The keying speed of the electronic keyer is fully adjustable. Selecting the appropriate speed is important in order to send error-free CW that other operators can copy solidly. Selecting a speed that is beyond your keying ability will only result in mistakes. You will obtain the best results by selecting a speed that is close to the speed used by the other station.

- 1 Press **[CW/ FSK/ REV]** to select CW mode.
  - “CW” appears.
- 2 Press **[KEY/ DELAY]**.
  - The current keying speed appears. The default is 20 (WPM).



- 3 While keying the paddle and listening to the transmit sidetone, turn the **MULTI/ CH** control to select the appropriate speed.
  - The speeds range from 10 (WPM) to 60 (WPM), in steps of 1. The larger the number, the faster the speed.
- 4 Press **[KEY/ DELAY]** again to complete the setting.

**Note:** When using the semi-automatic “Bug” function, the selected speed applies only to the rate that dots are sent.

### AUTO WEIGHTING

The electronic keyer can automatically change the dot/dash weighting. Weighting is the ratio of dash length to dot length. The weighting changes with your keying speed, thus making your keying easier for other operators to copy.

Use Menu No. 33 to select AUTO, or 2.5 ~ 4.0 (in steps of 0.1) fix weight ratio. The default is AUTO. When the fix weight ratio is selected, the dot/dash weight ratio is locked regardless of the keying speed.

#### Reverse Keying Weight Ratio

Auto Weighting increases the weighting as you increase your keying speed. However, the electronic keyer also can decrease the weighting as you increase your keying speed.

To switch this function ON, access Menu No. 34, and select ON. The default is OFF.

Reverse Keying Weight	Keying Speed (WPM)		
	10 ~ 25	26 ~ 45	46 ~ 60
OFF	1:2.8	1:3.0	1:3.2
ON	1:3.2	1:3.0	1:2.8

## BUG KEY FUNCTION

The built-in electronic keyer also can be used as a semi-automatic key. Semi-automatic keys are also known as “Bugs”. When this function is ON, dots are generated in the normal manner by the electronic keyer. Dashes, however, are manually generated by the operator by holding the keyer paddle closed for the appropriate length of time.

To switch this function ON, access Menu No. 35, and select ON. The default is OFF.

**Note:** When the Bug Key function is ON, CW Message Memory (see below) cannot be used.

## CW MESSAGE MEMORY

This transceiver has three memory channels for storing CW messages. Each memory channel can store approximately 50 characters (equivalent of 250 dots). These memory channels are ideal for storing contest exchanges that you want to send repeatedly. Stored messages can be played back to check message content or for transmitting.

The electronic keyer has a function that allows you to interrupt playback and manually inject your own keying. To switch this function ON, access Menu No. 30, and select ON. The default is OFF.

The electronic keyer can also repeatedly play back the message that you stored. To switch this function ON, access Menu No. 29A and select ON. The default is OFF.

For repetitive message playback, you can change the interval between each series of messages. Use Menu No. 29B, and select the time in the range of 0 to 60 seconds.

### Note:

- ◆ This function cannot be used when the Bug Key function is ON.
- ◆ Operating the keyer paddle with Menu No. 30 OFF cancels message playback. Even if message playback does not stop because of your keying start timing, you can cancel playback by pressing [CLR].

### Storing CW Messages

- 1 Press [CW/ FSK/ REV] to select CW mode.
  - “CW” appears.
- 2 If VOX is ON, press [VOX/ LEVEL].
  - The VOX LED turns off.
- 3 Press [FUNC] and [1/ CH1/REC], [2/ CH2/ REC], or [3/ CH3/REC] to select a memory channel to be recorded.



- 4 Begin sending using the keyer paddle.
  - The message you send is stored in memory.



- 5 To complete the message storage, press [CLR] to stop.
  - When the memory becomes full, recording automatically stops.

**Note:** If you do not operate the keyer paddle after starting to record a message, a pause is stored in the channel.

### Checking CW Messages without Transmitting

- 1 Press [CW/ FSK/ REV] to select CW mode.
  - “CW” appears.
- 2 If VOX is ON, press [VOX/ LEVEL] to switch it OFF.
- 3 Press [1/ CH1/REC], [2/ CH2/REC], or [3/ CH3/REC] to select the channel to be played back.
  - The message is played back.



- To play back the messages stored in the other channels in sequence, press the corresponding channel keys during playback. Up to three channels can be queued at the same time.
- While playing back the messages, you can also adjust the keyer speed by pressing [KEY/ DELAY] and turning the MULTI/ CH control.
- To interrupt playback, press [CLR].

### Transmitting CW Messages

Messages can be transmitted using Semi Break-in/ Full Break-in or manual TX/RX switching.

- 1 Press [CW/ FSK/ REV] to select CW mode.
  - “CW” appears.
- 2 To use Semi Break-in/ Full Break-in, press [VOX/ LEVEL]. The VOX LED lights. Otherwise, press [SEND].
- 3 Press [1/ CH1/REC], [2/ CH2/REC], or [3/ CH3/REC] to select the channel to be played back.
  - The message is played back and transmitted automatically.
  - To transmit the messages stored in the other channels in sequence, press the corresponding channel keys during playback. Up to three channels can be queued at the same time.

## 9 COMMUNICATING AIDS

- While playing back the messages, you can also adjust the keyer speed by pressing **[KEY/ DELAY]** and turning the **MULTI/ CH** control.
- To interrupt transmission, press **[CLR]**.

4 If you pressed **[SEND]** in step 2, press **[SEND]** again to return to receive mode.

### ■ Changing the Inter-message Interval Time

For the message playback repeat, select Menu No. 29A and set it ON. You can also change the interval playback time of the message. Use Menu No. 29B, and select the time in the range of 0 to 60 seconds, in steps of 1 second.

*Note: Menu Nos. 29A and 29B settings are shared with the voice communication modes when the optional DRU-3A is installed.*

### ■ Changing the Sidetone Volume

Turning the **MAIN AF** or **SUB AF** control does not change the CW sidetone playback volume. To change the CW sidetone volume, access Menu No. 13 and select OFF, or 1 to 9.

### ■ Insert Keying

If you operate a CW keyer manually while playing back a recorded CW message, the transceiver stops playing back the message. However, during contests or regular QSOs, you may sometimes want to insert a different number or message at a certain point in the recorded message.

In this case, first record the CW message as usual {page 43}, without the number or message you want to insert. Then, access Menu No. 30 and select ON.

Now if you operate a CW keyer while you play back a recorded message, the transceiver pauses the playback of the recorded message, instead of stopping it. When you finish sending the number or message with the keyer, the transceiver resumes playback of the message.

## FREQUENCY CORRECTION FOR CW

If you operate both SSB and CW modes, you would sometimes use SSB mode (USB or LSB) just to watch and listen CW signals. It is fine just to monitor those CW signals but you have experienced that changing the mode from SSB to CW results losing the target CW signal. This is because the frequency on the display always shows the true carrier frequency for all modes. If you want the transceiver to shift the receiving frequency to trace the receiving CW signal when changing the mode from SSB (USB or LSB) to CW, switch this function ON. The transceiver shifts the receiving frequency when changing the mode from SSB to CW. So, you can still hear the target signal and instantly transmit the signal in CW, without adjusting the frequency.

- 1 Press **[MENU]**, then turn the **MULTI/ CH** control to access Menu No. 37.
- 2 Press **[+]** to select ON.
- 3 Press **[MENU]** to store the settings and exit the Menu mode.

### CW REVERSE (RECEIVE)

This function pivots the BFO from the default position (USB) to another position (LSB) in CW mode. It is sometimes effective to remove the interfering signals from the IF passband by pivoting the BFO.

- 1 Press **[FUNC]**, **[CW/ FSK/ REV]**.
  - “CWR” appears.
- 2 To return to normal operation, press **[FUNC]**, **[CW/ FSK/ REV]** again.

### AUTO CW TX IN SSB MODE

If you operate both SSB and CW modes, you can configure the transceiver to change the operating mode from SSB (USB or LSB) to CW and then transmit in CW mode when you operate the CW keyers.

- 1 Press **[MENU]**, then turn the **MULTI/ CH** control to access Menu No. 36.
- 2 Press **[+]** to select ON.
- 3 Press **[MENU]** to store the settings and exit the Menu mode.

*Note: You must switch the CW break-in function ON to change the mode and transmit in CW mode {page 42}.*

# SUB-RECEIVER

## SUB-RECEIVER

The TS-2000(X) transceiver is equipped with 2 independent receivers. The main transceiver can receive from 30 kHz to the UHF band (or 1.2 GHz band if the optional UT-20 is installed) while the sub-receiver can receive signals in FM or AM mode on the VHF (144 MHz) or UHF (430/ 440MHz) band.

You can assign the sub receiver to monitor the local repeater activities or your club channel while you are operating on the HF/ 50MHz or VHF/ UHF/ (Optional 1.2 GHz) bands with the main transceiver.

Since the TS-2000 also has a built-in TNC, you can assign the sub-receiver to monitor the local DX Packet Cluster channel activities without using an external TNC. If a new DX station is reported to the DX Packet Cluster, the transceiver automatically displays the DX station data. If desired, you can further transfer the DX frequency information to the main transceiver to watch and instantly make contact with the DX station {page 53}.

## TX BAND AND CONTROL BAND

In this manual, the frequency on the left of the display is referred to as the MAIN band and the frequency on the right is called the SUB band.

To understand how to control the MAIN band and SUB band frequencies and functions, please note the differences between the TX band and the Control band, below.

### TX BAND

Press **[MAIN]** to display the “**PTT**” and “**CTRL**” icons on the MAIN band. When “**PTT**” is on the MAIN band display, the MAIN band is currently selected as the transmission band. You can use the MAIN band frequency to transmit signals or to control the main transceiver functions.

If you press **[SUB]**, the “**PTT**” and “**CTRL**” icons move to the SUB band display. This means that the SUB band is now selected as the transmission band and controls the functions. You can use the SUB band frequency to transmit signals or control the sub receiver functions.

### CONTROL BAND

On some occasions, you may need to adjust the frequency and/ or functions for the band you are not transmitting on. To do this, press **[CTRL]**. For example, if both “**PTT**” and “**CTRL**” are on the MAIN band display, pressing **[CTRL]** will move “**CTRL**” to the SUB band display. “**PTT**” remains on the MAIN band display. This allows you to continue transmitting on the MAIN band while you adjust the functions of the sub-receiver.

## RECEIVING

### ACTIVATING THE SUB-RECEIVER

Press the **SUB AF** control to switch the sub-receiver ON or OFF. The orange LED above the **SUB AF/ SQL** control lights when the sub-receiver is switched ON.

*Note: When switching the sub-receiver ON or OFF, you may hear a popping sound from the speaker. This is not a malfunction.*

### CONTROLLING THE SUB-RECEIVER

To control all the available functions of the sub-receiver, press **[SUB]** to transfer the controls and transmission capability to the sub-receiver. The “**PTT**” and “**CTRL**” icons move from the main transceiver to the sub-receiver. When you press **[SEND]** or Mic **[PTT]**, the transceiver transmits on the SUB band frequency.



Or, if you would like to transmit and receive on the MAIN band while adjusting the sub-receiver functions, simply press **[CTRL]**. Only the “**CTRL**” icon moves from the main transceiver display to the sub display. The “**PTT**” icon remains on the main transceiver display. With this setup, you can continue receiving and transmitting on the main transceiver VFO frequencies while you are making adjustments to the sub-receiver functions.



If you need to adjust only the frequency of the sub-receiver, you can simply turn the **RIT/ SUB** control. However, this works only when you are operating the main transceiver without the RIT/ XIT functions. When operating the main transceiver with the RIT/ XIT function, first switch OFF the RIT/ XIT function by pressing **[RIT/ CW TUNE]** and/or **[XIT/ ALT]**, or press **[CTRL]** to move the controls to the SUB band. Then turn the **Tuning** control, the **MULTI/ CH** control or the **RIT/ SUB** control to adjust the SUB band frequency.

### SELECTING A BAND

Press **[SUB]** or **[CTRL]** to assign the function controls to the sub-receiver.

Press **[+]**/ **[-]** to select the 144 MHz or the 430/ 440 MHz band.

## 10 SUB-RECEIVER

- Holding down the key changes the bands continuously.
- If “MHz” is visible on the display, first press [1MHz/SEL] to exit from the 1 MHz Step Up/Down mode.

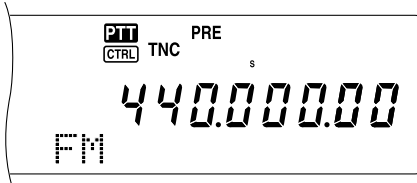

### ADJUSTING THE AUDIO FREQUENCY (AF) GAIN

Turn the **SUB AF** control clockwise to increase the audio level and counterclockwise to decrease the level.

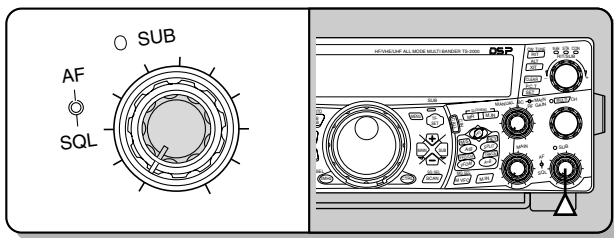

**Note:** The position of the **SUB AF** control does not affect the volume of beeps caused by pressing buttons. The audio level for Packet operation is also independent of the **SUB AF** control setting.

### ADJUSTING THE SQUELCH

Turn the **SUB SQL** control clockwise when no signals are present, to select the squelch level at which background noise is just eliminated. The SUB band LED turns off when the squelch is ON.

### SELECTING A FREQUENCY

When you operate both the main transceiver and the sub-receiver at the same time, you will be in one of the following conditions. First, check where the “PTT” and “CTRL” icons are on the display, then follow the instructions below.

The “PTT” and “CTRL” icons are both on the MAIN band display:

- Turn the **RIT/ SUB** control to adjust the sub-receiver frequency.

“PTT” is on the SUB band display and “CTRL” is on the MAIN band display:

- Turn the **RIT/ SUB** control to adjust the sub-receiver frequency.

“PTT” is on the MAIN band display and “CTRL” is on the SUB band display:

- Turn the **RIT/ SUB** control, the **MULTI/ CH** control, or the **Tuning** control to adjust the frequency. Or, directly enter the frequency using the numeric keypad {page 37}. However, the input frequency must be within the sub-receiver frequency range. The frequency you selected may round up to the nearest workable frequency step size {page 37}. You cannot transmit on the sub-band frequency.

The “PTT” and “CTRL” icons are both on the sub-receiver display:

- You can do all the above, plus transmit on the SUB band frequency.

This transceiver provides many other methods for selecting a frequency quickly. For further details, refer to “SELECTING YOUR FREQUENCY” {page 37}.

### SUB-RECEIVER PANEL METER

The multifunction meter measures the parameters described in the table below. The S-meter appears when in receive mode and the PWR meter appears when in transmit mode. Peak readings for the S-meter and PWR functions are held momentarily.

Scale	Display	Function State
S	Received signal strength	Receive
PWR	Transmit output power	Transmit

**Note:** Peak Hold readings cannot be deactivated.

### SELECTING A MODE FOR THE SUB-RECEIVER

First, confirm that the “CTRL” icon is on the SUB band display. If it is not, press [SUB] or [CTRL] to assign the function controls to the SUB band.

The SUB band can only be used to transmit in FM mode and receive in FM or AM mode. Press [FM/AM/NAR] to toggle the operating mode for the sub-receiver. The narrow bandwidth operation for AM is not available for the SUB band frequency. Refer to “NARROW BANDWIDTH FOR FM” {page 29} for FM operation.

### FM CTCSS OPERATION

You can assign an independent CTCSS tone to the sub-receiver. Refer to “FM CTCSS OPERATION” {page 35} for function and control details.

### FM DCS OPERATION

You can assign an independent DCS code to the sub-receiver. Refer to “FM DCS OPERATION” {page 36} for function and control details.

### TONE FREQ. ID SCAN

This function scans through all the tone frequencies in order to identify the incoming tone frequency on the receiving signal of the sub-receiver. Refer to “TONE FREQ. ID SCAN” {page 34} for function and control details.

### DCS CODE ID SCAN

This function scans through all the DCS codes in order to identify the incoming DCS code on the receiving signal of sub-receiver. Refer to “DCS CODE ID SCAN” {page 36} for function and control details.



## ATTENUATOR

The attenuator reduces the level of received signals. It is useful when there is strong interference from an adjacent frequency. Since the main transceiver and sub-receiver share the same antenna for the 144 MHz and 430/ 440 MHz bands, activating the attenuator function for the sub-receiver also causes the function to switch ON for the same band of the main transceiver.

## PRE-AMPLIFIER

The pre-amplifier amplifies the level of received signals. It is useful when the receiving signal is weak. If there is no strong interference from adjacent frequencies, switch the pre-amplifier ON to raise the receiving signal level. Since the main transceiver and sub-receiver share the same antenna for the 144 MHz and 430/ 440 MHz bands, activating the pre-amplifier function for the sub-receiver also causes the function to switch ON for the same band of the main transceiver.

## DUAL WATCH

If different frequency bands are set on the main transceiver and sub-receiver, you can still monitor the other band activities while transmitting on the TX band. It is useful that you can still monitor the local repeater frequency (VHF or UHF band) while you are working on a DX station on the HF band of the main transceiver.

If you have the same frequency band (VHF or UHF band) for the main transceiver and sub-receiver, you can monitor both frequencies independently at the same time. However, both receivers will temporarily mute when you transmit because the transceiver shares the same 144 MHz and 430/ 440 MHz band antenna between the main transceiver and sub-receiver.

## SCAN

All types of scanning are also available for the sub-receiver. However, the operating frequency range is limited to the sub-receiver's frequency coverage. Refer to "SCAN" {page 66} for details on how to operate the scan function.

## NOISE REDUCTION

Since the sub-receiver can receive only in FM or AM mode, DSP noise reduction 1 (Line Enhanced) is available to reduce the noise from the receiving signals. Refer to "NOISE REDUCTION" {page 56} for details on how to control and adjust the function.

## TRANSMITTING

First, confirm that the "PTT" icon is on the SUB band display. Press [SEND] or press and hold Mic [PTT], then speak into the microphone in your normal tone of voice. When you finish speaking, press [SEND] again or release Mic [PTT].

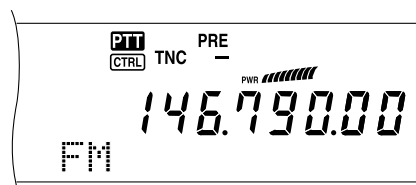

## SELECTING A TRANSMIT POWER

You can also adjust the output power for FM mode on the 144 MHz and 430/ 440 MHz bands when you are operating the sub-receiver.

- 1 Press [PWR].
  - The current transmit power appears.



- 2 Turn the **MULTI/ CH** control counterclockwise to reduce the power or clockwise to increase the power.



### Note:

- ◆ The selectable range varies depending on the band and mode {page 79}.
- ◆ Output power configuration is also reflected in the main transceiver.

## MICROPHONE GAIN

Access Menu No. 41 and select "LOW", "MID", or "HIGH" for the microphone gain.

**Note:** When using the optional MC-90 microphone in FM mode, select "HIGH" microphone gain. Microphone sensitivity is low in FM mode; this may cause insufficient modulation. For other microphones, select "MID" or "LOW".

## FM REPEATER OPERATION

You can also configure an independent repeater offset frequency for the sub-receiver, if necessary. Refer to "FM REPEATER OPERATION" {page 32} for details.

## REVERSE FUNCTION

Press [TF-SET] to switch the sub-receiver Reverse function ON (or OFF). "R" appears while the Reverse function is active on the sub-receiver. Refer to "REVERSE FUNCTION" {page 34} for details.

---

## 10 SUB-RECEIVER

---

### AUTOMATIC SIMPLEX CHECK (ASC)

You can also use ASC functions on the 144 MHz and 430/ 440 MHz bands of the sub-receiver. While using a repeater, ASC periodically monitors the strength of the uplink frequency to check the signals. Press and hold **[TF-SET]** until “[R]” appears on the SUB band display. Refer to “AUTOMATIC SIMPLEX CHECK” {page 34} for function and control details.

### TRANSMITTING A TONE

You can assign another Tone to the sub-receiver. Refer to “TRANSMITTING A TONE” {page 33} for function and control details.

### MEMORY

You can also utilize all the memory functions {page 58}, including the Quick Memory function {page 64}, while you are operating the sub-receiver. However, the operating frequency range is limited to the sub-receiver’s frequency coverage. You cannot recall any memory channels that are outside the sub-receiver’s frequency coverage. These channels are automatically skipped when they are recalled on the sub-receiver.

## PACKET RADIO

Packet is a unit of data transmitted as a whole from one computer to another, on a network. Packets can be transmitted on radio waves as well as on communications lines. Besides a transceiver and a computer, all you need is a terminal node controller (TNC) or Multimode Communications Processor (MCP). One of the tasks of TNCs and MCPs is to convert data packets to audio tones, and vice versa. This transceiver has a built-in TNC which allows you to use basic (not full) packet applications.

A variety of packet applications developed by hams include packet bulletin board systems (PBBSs). PBBSs are created and maintained by volunteers called System Operators (SysOp). You may access one of your local PBBSs to send e-mail, download files, or obtain various useful information. Thousands of PBBSs, which have formed a worldwide network, relay e-mail to their intended destinations around the world.

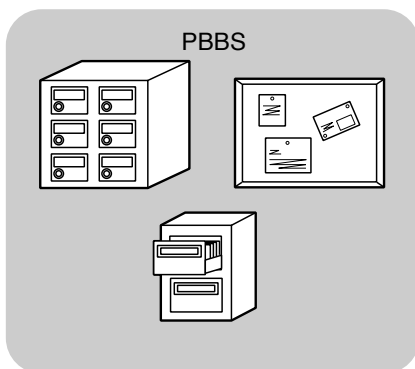

When you access a local PBBS for the first time, you often need to register as a new user. After you are successfully registered, it will then be available as your home PBBS. E-mail addressed to you will be held under a directory, called a mailbox, on your home PBBS.

To send e-mail, you must designate the address of a recipient, using his or her call sign and the call sign of his or her home PBBS; ex. KD6NUH@KJ6HC. In this example, the e-mail is addressed to KD6NUH whose home PBBS is KJ6HC. If your home PBBS cannot find KJ6HC in its address file to forward your mail, you must designate the address in more detail. You may enter "KD6NUH@KJ6HC.#ABC.CA", or "KD6NUH@KJ6HC.#ABC.CA.USA", or up to "KD6NUH@KJ6HC.#ABC.CA.USA.NA", as necessary. The complete address of a recipient living in the U.S.A., for example, should include an appropriate region code (preceded by a #), state, country, and continent abbreviations, as above.

For further information, consult reference books which should be available at any store that handles Amateur Radio equipment. Web pages relating to Packet will also be helpful. On Internet search engines, use "Packet Radio" as key words to find those Web pages.

### Note:

- ◆ Unlike a TNC, a Multimode Communications Processor (MCP) serves as a communications interface in several digital modes such as Packet, RTTY, and AMTOR. You can cause it to switch among the modes by sending a single command from your computer.
- ◆ If there is an amateur radio club in your area, consider becoming a member. You can often learn more in an hour from experienced hobbyists, than in a month of independent research. Ask on the local repeaters, or contact your national amateur radio organization (the ARRL in the U.S.A.) for information on local amateur radio clubs. You'll be glad you did.

## BUILT-IN TNC

This transceiver has a built-in TNC which conforms to the AX.25 protocol. Since the built-in TNC has been designed to work with the Packet Cluster Tune {page 53} and Sky Commander II+ {page 83} functions, some of the enhanced TNC commands may not be available. For the commands supported by the built-in TNC, consult "BUILT-IN TNC COMMAND LIST" starting on page 110. The AX-25 protocol is used for communication between TNCs. The TNC accepts data from your personal computer and assembles it into packets. It then converts those packets to audio tones which the transceiver can transmit. The TNC also takes audio tones from the transceiver, converts them to data for the computer, and checks for errors in the data.

In order to activate the built-in TNC, access Menu No. 55 and select ON. The default is OFF. "PKT" will appear to show that the built-in TNC is ON.

The TNC mainly functions in Command or Converse mode. First, you should learn the difference between these two modes.

### • Command mode

When you select Packet mode, the TNC enters Command mode. A "cmd:" prompt appears on the computer screen. You can type commands from the computer keyboard to change the settings of the TNC. When in Converse mode, press **[Ctrl]+[C]** on the keyboard to return to Command mode.

### • Converse mode

The TNC enters this mode when a link with the target station is established. On the computer keyboard, type an appropriate command and a message if necessary, then press **[Enter]** or **[Return]**. What you type is converted into packets and transmitted over the air. When in Command mode, type CONVERSE, CONV, or K to enter Converse mode.

**Note:** The built-in TNC automatically reinitiates when a malfunction is detected; this does not designate that the transceiver is defective.

# 11 SPECIALIZED COMMUNICATIONS

## PREPARATION

- 1 Connect the transceiver to your personal computer (via an external TNC or MCP if desired).
  - See “COMPUTER” {page 93} and “MCP AND TNC” {page 95}.
- 2 Install an appropriate terminal program onto the personal computer.
  - A variety of freeware and shareware programs can be obtained in various ways. Consult your reference material or other “packeteers”.
- 3 Initiate the terminal program and set the following parameters on the personal computer:
  - Transfer rate (TNC/MCP <--> Computer): 9600 bps (default setting)
  - Data length: 8 bit
  - Stop bit: 1 bit
  - Parity: Non-parity
  - Flow control: Hardware
- 4 Press **[A/B]** to select VFO A or VFO B.
- 5 Access Menu No. 46 and select the main band or the sub-band (default) as the data band.
  - “TNC” appears on the data band.
  - If you are using an external TNC or MCP, access Menu No. 50E to make this selection. The default is main band.
- 6 Access Menu No. 47 and select 1200 bps (default) or 9600 bps as the transfer rate between TNCs.
  - You must select the same transfer rate as the target station.
  - If you are using an external TNC or MCP, access Menu No. 50F to make this selection. The default is 1200 bps.
- 7 Select an operating frequency.
- 8 Press **[LSB/ USB/ AUTO]** or **[FM/ AM/ NAR]** to select LSB, USB, or FM mode.
- 9 Access Menu No. 50A and select ON to activate the DSP packet filter for the main transceiver.
- 10 Turn the **HI/ SHIFT** control to select the center frequency of the packet mode. You can further select either “NAR” (narrow) or “WID” (wide) for the receiver filter width by turning the **LO/ WIDTH** control.

Center Frequency	Operating Mode
1000 Hz	PSK31
1700 Hz	Packet (AFSK 1200 bps)
2210 Hz	Packet (AFSK 300 bps)
PSK	PSK

**Note:**

- ◆ The packet (9600 bps) operation is not affected by the DSP packet filter settings.
- ◆ The DSP packet filter works only on the main transceiver.

If you are using an external TNC or MCP, proceed with the subsequent steps.

- 11 Following the instructions provided with your TNC or MCP, enter the calibration mode so that you can generate a mark condition.
  - The **MAIN** band LED changes from green (RX) to red (TX).
- 12 Access Menu No. 50B to select the appropriate AF input level.
  - Select a proper input level, so that the ALC meter reflects within the ALC zone.
- 13 Exit the calibration mode.
  - The **MAIN** band LED changes from red (TX) to green (RX).
- 14 Access Menu No. 50C to select the appropriate AF output level.
  - You cannot use the **AF** control to make this adjustment.
  - If you have selected sub-band in step 5, access Menu No. 50D instead.

The frequencies (measured in kHz) commonly used for Packet are listed below:

U.S.A./ Canada	IARU Region 1 (Europe/ Africa)
1800 ~ 1830	—
3620 ~ 3635	3590 ~ 3600
7080 ~ 7100	—
10140 ~ 10150	—
14095 ~ 14099.5	14089 ~ 14099, 14101 ~ 14112
18105 ~ 18110	—
21090 ~ 21100	21100 ~ 21120
28120 ~ 28189	28120 ~ 28150, 29200 ~ 29300
50600 ~ 50780	—
144910 ~ 145090	—
440975 ~ 441075	430050 ~ 431025

## DCD SENSE

You can also select the method for inhibiting the built-in TNC from transmitting. Access Menu No. 48 and select one of the two methods. The default is “TNC BAND”.

**TNC BAND:**

The TNC does not transmit when signals are present on the TNC (data) band.

**MAIN&SUB:**

The TNC does not transmit when signals are present on the main transceiver or sub-receiver.

## RADIO TELETYPEWRITING (RTTY)

RTTY is the data communications mode with the longest history. It was originally designed for use with mechanical teletypewriters which were often used before personal computers became common. Now you can easily start operating RTTY with a personal computer and MCP. Unlike Packet, each time you type a letter, it is transmitted over the air. What you typed is transmitted and displayed on the computer screen of the recipient.

RTTY operation uses frequency shift keying (FSK) and the 5-bit Baudot code or the 7-bit ASCII code to transmit information.

For the cable connections, see "RTTY" {page 95}.

For further information, consult reference books about Amateur Radio.

- 1 Access Menu No. 38 and select an FSK shift.
  - FSK shift is the difference in frequencies between a mark and a space.
  - The 170 Hz default is used on the Amateur bands.
- 2 Access Menu No. 39 and select a key-down polarity.
  - Select "NORMAL" to transmit a mark when keying down or "INVERS" to transmit a space. The default is "NORMAL".
- 3 Access Menu No. 40 and select high tone (2125 Hz) or low tone (1275 Hz) for mark.
  - High tone (default) is commonly used nowadays.
- 4 Select an operating frequency.
- 5 Press **[CW/ FSK/ REV]** to select FSK.
  - "FSK" appears.

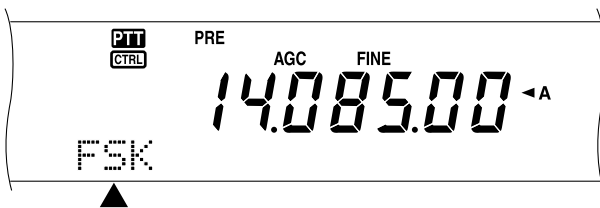

- 6 If necessary to be compatible with the other station, press **[FUNC], [CW/ FSK/ REV]** to reverse the transceiver to the upper sideband.
  - "FSR" appears.



- Traditionally, the lower sideband is used for FSK operation.
- Press **[FUNC], [CW/ FSK/ REV]** to return to the lower sideband.

- 7 Following the instructions provided with your MCP, enter a command from your computer to select transmit mode.
  - The **MAIN** band LED changes from green (RX) to red (TX).
  - You may instead press **[SEND]** to manually select the transmit mode.
- 8 Begin sending data from your computer.
  - Use Menu No. 50C to select the appropriate AF output level. The **AF** control cannot be used for this adjustment.
  - Press **[FUNC], [PWR/ TX MONI]** to monitor your signals. Press **[FUNC], [PWR/ TX MONI]** again to quit this function.
- 9 When finished transmitting, enter a command from your computer to return to receive mode.
  - The **MAIN** band LED changes from red (TX) to green (RX).
  - If you pressed **[SEND]** in step 7, press **[SEND]** again.

The frequencies (measured in kHz) commonly used for RTTY operation are listed below:

U.S.A./ Canada	IARU Region 1 (Europe/ Africa)
1800 ~ 1840	1838 ~ 1842
3605 ~ 3645 (DX: 3590)	3580 ~ 3620
7080 ~ 7100 (DX: 7040)	7035 ~ 7045
10140 ~ 10150	10140 ~ 10150
14070 ~ 14099.5	14080 ~ 14099.5
18100 ~ 18110	18101 ~ 18109
21070 ~ 21100	21080 ~ 21120
24920 ~ 24930	22920 ~ 24929
28070 ~ 28150	28050 ~ 28150

*Note: You may adjust the carrier level when necessary. Press **[FUNC], [MIC/ CAR]** to enter the adjustment mode. With a key down condition, turn the **MULTI/ CH** control so that the ALC meter reads in the ALC zone but does not exceed the upper ALC zone limit.*

## 11 SPECIALIZED COMMUNICATIONS

### PHASE-SHIFT KEYING 31 BAUD (PSK31)

PSK31 is a digital modulation method used in amateur radio communications. You can perform data communications in real-time using a keyboard, like RTTY. Additionally, because of the narrow bandwidth (31.25 Hz) you can even use PSK31 on congested frequencies. Another merit to PSK31 is that it can be enjoyed with a simple antenna and low transmit power.

Using the sound function of your PC along with PSK31 software, many amateur radio operators enjoy PSK31.

- See “PREPARATION” {page 50}.
- When managing PSK31 using the sound capability of a PC, use SSB mode.
- Set AGC to fast.
- Turn off the speech processor.

For further information, consult reference books about Amateur Radio.

### SLOW SCAN TV/ FACSIMILE

Slow-scan Television (SSTV) is a popular application for transmitting still images over the air, from one station to another. Instead of trying to describe your station, simply showing it is much faster. Transmitting images over the air requires a scan converter, besides a transceiver. A scan converter transforms images taken with a video camera into audio signals that can be fed into your transceiver. The recipient's scan converter transforms audio signals back into video images so that he or she can view them on a TV set.

Nowadays instead of a scan converter, many hams use a personal computer, a software application, and an interface attached to the transceiver. This is much cheaper, more flexible, and does not require a TV set. In recent years, many low cost digital cameras have become available. You can transfer images from these cameras into your computer.

For further information, consult reference books about Amateur Radio. The frequencies (measured in kHz) commonly used for SSTV operation are listed below:

U.S.A./ Canada	IARU Region 1 (Europe/ Africa)
3845, 3857	3730 ~ 3740
7171	7035 ~ 7045
14230, 14233	14225 ~ 14235
21340	21335 ~ 21345
28680	28675 ~ 28685
145500	—

Fax (facsimile) is one of the original image transmission modes. Using this mode allows you to exchange more detailed graphics than SSTV.

Amateur Radio fax functions much like old analog fax systems. It scans paper and converts acquired image data into a series of tones representing white and black portions of the image. Because fax requires longer transmission time, you should use it only when band conditions are stable with strong signals.

Popular fax frequencies include the following:

- 7245, 14245, 21345 (International Net), and 28945 kHz

Operating on SSTV or fax mainly involves learning the functionality of your computer application or accessory hardware that supports these modes. Consult the instruction manual that comes with your software or accessory equipment.

*Note: When operating either SSTV or fax, use a fast AGC setting and switch OFF your Speech Processor, for best results.*

### DX PACKET CLUSTER TUNE

DX Packet Cluster is a packet network which consist of nodes and stations who are interested in DXing and contesting. If one station finds a DX station on the air, he or she sends a notice to his or her node. This node then passes the information to all its local stations as well as another node. This transceiver can display received DX information and hold the latest information on up to 10 DX stations.

This transceiver is also capable of automatically tuning in a reported DX station. In order to use the Auto Tune function, access Menu No. 49A and select “AUTO”; the default is “MANUAL”.

- 1 Press **[A/B]** to select VFO A or VFO B.
- 2 Press the **SUB AF** control to activate the sub-receiver if it is switched OFF.
  - The orange **SUB** LED lights {page 45}.
- 3 Tune to the frequency of the target DX Packet Cluster node on the sub-receiver.
- 4 Access Menu No. 46 to confirm that “SUB” is selected.
- 5 Press **[FUNC]**, **[SET/ P.C.T.]** to enter the Packet Cluster Tune (P.C.T.) mode.
  - Each time new DX Packet Cluster data is received, the DX station's callsign in Morse code sounds and the information is displayed on the sub-receiver as shown below:

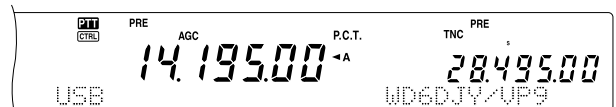

- 6 If you are not using the Auto Tune function, press **[SET/ P.C.T.]**.
  - The main transceiver is tuned to the frequency of the reported DX station, on the sub-receiver.
  - Transmitting on the tuned frequency, the transceiver exits the P.C.T. mode. Press **[FUNC]**, **[SET/ P.C.T.]** again to reactivate it if necessary.

7 Press **[FUNC]**, **[SET/ P.C.T.]** to exit the P.C.T. mode.

To access desired DX information in the P.C.T memory, press **QUICK MEMO [MR]**, then turn the **MULTI/ CH** control. Press **[SET/ P.C.T.]** to tune the main band to the selected station. Press **QUICK MEMO [MR]** again to quit the DX information display.

The transceiver can be set to output a beep instead of a Morse code when new DX Packet Cluster data is received. Access Menu No. 49B and select "OFF". "VOICE" can also be set when you install the optional VS-3 {page 91}.

**Note:**

- ◆ You cannot send DX information to a node using this function.
- ◆ The DX Packet Cluster data in memory is retained when the transceiver is turned OFF. However, the sub-receiver's frequency display returns to the receiving frequency of the DX Packet Cluster node.

**SATELLITE OPERATION**

Amateur satellites receive on one band and transmit on another. Unlike in regular operation, Satellite mode can handle uplink/ downlink frequency combinations simultaneously in all operating modes as shown below.

		UPLINK				
		Band	HF ~ 50 MHz	144 MHz	430/ 440 MHz	1.2 GHz
DOWN LINK	HF ~ 50 MHz		√	√	√	√
	144 MHz	√		√	√	√
	430/ 440 MHz	√	√		√	√
	1.2 GHz	√	√	√		√

Some satellites require a rotator that allows azimuth and elevation control, plus a high-gain directional antenna. The antenna must track the satellite which travels from horizon to horizon. Even so, many hams have been successfully using fixed omnidirectional antennas. If you are using a directional antenna, it would be wise to obtain a pass prediction program.

Doppler Shift is another aspect that you must take into account when working the satellites. As a target satellite travels away, frequencies on which you will receive change. This transceiver has a function that automatically keeps the sum or difference between the two frequencies identical when you change the receive frequency.

For further information, consult Internet Web pages relating to Amateur satellites. On Internet search engines, use "AMSAT" as key words to find those Web pages. Or, you can directly go to the AMSAT (the Radio Amateur Satellite Corporation) homepage at <http://www.amsat.org>. From AMSAT Web pages, you can download a variety of utilities, including pass prediction programs, which will ease your satellite operations.

Sub-audible tone functions (Tone/ CTCSS/ DCS) in Satellite mode:

- FM sub-audible tone functions (Tone/ CTCSS/ DCS) can be enabled in Satellite mode and the Tone On/Off status can be stored in each Satellite memory channel.
- Although the Tone On/Off status is stored in each Satellite memory channel, the sub-audible tone frequency/ code cannot be stored due to limited memory capacity. The tone frequency/ code configuration from the normal VFO (VFO-A or VFO-B) is used instead.
- The tone frequency/ code search function cannot be operated in Satellite mode.
- Encoding and decoding is performed according to the data from the uplink frequency band.

**BASIC OPERATION**

When you enter the Satellite mode, you are always controlling one of 10 Satellite Memory channels with the adjustable frequency function. The Satellite Memory channel number (0 ~ 9) appears on the main transceiver's display when you enter the mode.

- 1 Press **[SATL]** to enter Satellite mode.
  - The default downlink (435.9 MHz) and uplink (145.9 MHz) frequencies appear.
  - "TRACE", "A", and "SUB" appear to indicate the current selections.



- 2 On VFO A, tune to the downlink (RX) frequency of the satellite.
- 3 Press **[LSB/ USB/ AUTO]** or **[CW/ FSK/ REV]** to select LSB, USB, or CW mode.
- 4 As the Satellite moves, fine tune to the changing downlink (RX) frequency of the satellite using the **Tuning** control (adjusting the Doppler effect).
  - As you adjust the downlink (RX) frequency, the Trace function automatically changes the uplink frequency so that the sum of the two frequencies is kept the same (Reverse Trace).
  - If necessary, press **[A=B / TRACE]** to quit the Trace function. "TRACE" disappears.
  - The trace function can also change the uplink (TX) frequency so that the difference between the two frequencies is kept the same (Normal Trace).
- 5 If you want to switch to the normal trace mode, press **[SPLIT / REV]**. "A" disappears.
- 6 To adjust the frequency on the sub-band display (normally the uplink frequency) without tracing, turn the **RIT/ SUB** control. To adjust it using the trace function, press **[A/B / M/S]** to swap the main band frequency and sub-band frequency then turn the **Tuning** control or **MULTI/ CH** control. The following table shows which control to use when

## 11 SPECIALIZED COMMUNICATIONS

adjusting frequencies with tracing ON and OFF.

	TRACE/ TRACE R ON	TRACE/ TRACE R OFF
Tuning control (Normal)	Main and Sub	Main
MULTI/ CH control (Coarse)	Main and Sub	Main
RIT/ SUB control	Sub	Sub

### STORING SATELLITE MEMORY CHANNELS

You can store all the above settings to one of 10 Satellite memory channels for the future operations.

- 1 Press **[M.IN]**, then turn the **MULTI/ CH** control to select a channel from 0 to 9.
- 2 Select your desired settings.
- 3 Press **[M.IN]** again to store the selection to the memory channel. To quit, press **[CLR]**.

*Note: The Satellite Memory channel does not hold the frequency adjustment values when the channel is changed. So, when you change the channel number or switch the transceiver OFF, the adjustment frequency values are cleared if they are not stored by pressing **[M.IN]**.*

### RECALLING A SATELLITE MEMORY CHANNEL

- 1 Press **[VFO/M / VFO/CH]**.
  - The MULTI/ CH LED lights.
- 2 Turn the **MULTI/ CH** control to select the desired Satellite Memory channel.
- 3 Press **[VFO/M / VFO/CH]** to return to the frequency adjustment mode.

### SATELLITE CHANNEL NAME

You can name each Satellite Memory channel using a maximum of 8 alpha-numeric characters. First, store the settings to the Satellite Memory channel {above}. To store the Satellite Channel name:

- 1 Press **[M.IN]** then turn the **MULTI/ CH** control to select the Satellite Memory channel.
- 2 Press **[DISP]**.
- 3 An entry cursor appears. Select a character by turning **MULTI/ CH** control, then move the cursor using **[SUB]** or **[MAIN]**. You can also use the other methods to enter the characters. Refer to page 63 for details.
- 4 Press **[M.IN]** to store the name to the Satellite Memory channel. Press **[CLR]** to quit.
- 5 The stored Satellite Memory name appears on the main dot-matrix display.

### QUICK MEMORY IN SATELLITE MODE

While in the Satellite mode, only 1 Quick Memory

channel is available. It uses Satellite Memory channel 9 to store the settings. To store the settings to the Quick Memory in Satellite mode, press **QUICK MEMO [M.IN]**. The settings are stored to Satellite Memory channel 9.

To recall the Quick Memory, press **QUICK MEMO [MR]** or select Satellite Memory channel 9, using the **MULTI/ CH** control. Satellite Memory channel 9 is recalled.

### CHECKING THE UPLINK FREQUENCY

When you need to monitor the uplink (TX) frequency, press **[TF-SET]**. Each time you press **[TF-SET]**, the uplink (TX) frequency and the downlink (RX) frequency are swapped.

### USING XIT/ RIT IN SATELLITE MODE

You can also use the RIT or XIT function while in the Satellite mode. Press **[RIT/ CW TUNE]** or **[XIT/ ALT]** to activate the function. When the RIT or XIT function is ON, the sub-band frequency display shows the current RIT or XIT offset frequency instead of the operating frequency. To clear the RIT or XIT offset frequency, press **[CLEAR]**.

*Note: You cannot activate both the RIT and XIT functions at the same time in the Satellite mode.*

### CHANGING THE FREQUENCY BAND

If you need to change the uplink and/or downlink frequency band, press **[CTRL]** to move the "**CTRL**" icon to the frequency band that you want to change. Then, press **[+]/ [-]** to select the band you want to operate.



# REJECTING INTERFERENCE

## DSP FILTERS

**KENWOOD** digital signal processing (DSP) technology is used for the functions described in this section. Using DSP filtering, the TS-2000 frees you from installing many analog filters for each operating mode. Additionally, you can control the bandwidth, cancel the multiple jamming beat, and reduce the noise level using DSP filtering technology.

### CHANGING THE RECEIVE FILTER BANDWIDTH

For improving interference reduction capability, this transceiver also provides IF filters designed using DSP technology. When in SSB, FM, or AM mode, you can change the filter bandwidth by altering its low and/or high cut-off frequency. For CW and FSK modes, you can change the filter bandwidth by directly specifying a bandwidth. Changing the filter bandwidth does not affect the current receive frequency.

**Note:**

- ◆ The receive filter bandwidth can be changed only on the main transceiver.
- ◆ The IF DSP filter is not available in FM mode.

#### ■ SSB/ FM/ AM Modes

- 1 Select SSB, FM, or AM mode.
- 2 Press **[DISP]**.
  - The current filter selection appears.
- 3 Turn the **LO/ WIDTH** control clockwise to raise the low cut-off frequency, or counterclockwise to lower the low cut-off frequency.

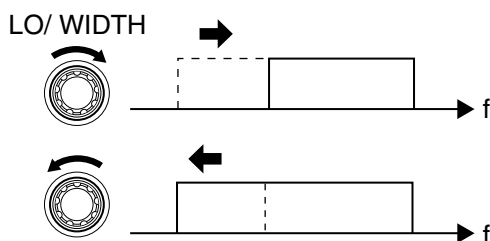

Turn the **HI/ SHIFT** control clockwise to raise the high cut-off frequency, or counterclockwise to lower the high cut-off frequency.

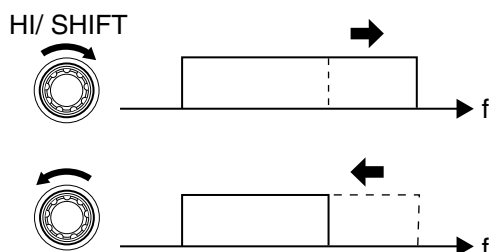

Adjust	Frequency Selections (Hz)
LO/ WIDTH	0, 50, 100, 200, 300, 400, 500, 600, 700, 800, 900, 1000
HI/ SHIFT	1400, 1600, 1800, 2000, 2200, 2400, 2600, 2800, 3000, 3400, 4000, 5000

Mode	Default low-cut frequency (Hz)	Default high-cut frequency (Hz)
SSB/ FM	300	2600
AM	100	5000

- 4 To return the display to the current operating mode, press **[DISP]**.

**Note:**

- ◆ The cut-off frequencies can be adjusted independently for each operating mode. When you change the operating mode, the previous setting is recalled for each operating mode.
- ◆ When the Packet filter (Menu No. 50A) is ON, you cannot change the DSP filter bandwidth. Switch the Packet filter OFF to adjust the DSP filter bandwidth.

#### ■ CW/ FSK Modes

- 1 Press **[CW/ FSK/ REV]** to select CW or FSK mode.
- 2 Press **[DISP]**.
  - The current filter selection appears.
- 3 Turn the **LO/ WIDTH** control clockwise to increase (wide) the bandwidth, or counterclockwise to decrease (narrow) the bandwidth.

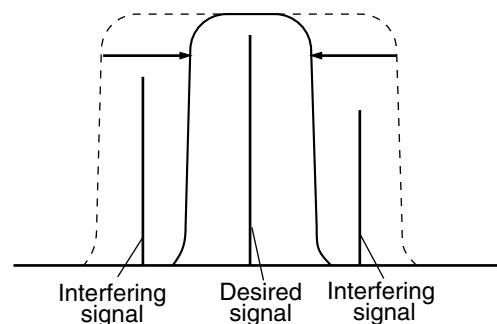

Mode	Bandwidth Selections (Hz)	Default (Hz)
CW	50, 80, 100, 150, 200, 300, 400, 500, 600, 1000, 2000	600
FSK	250, 500, 1000, 1500	1500

- 4 As for CW, you can further adjust the shift frequency for passband. Turn the **HI/ SHIFT** control to adjust the shift frequency from 400 to 1000 Hz in steps of 50 Hz. The default shift frequency is 800 Hz.
- 5 To return the display to the current operating mode, press **[DISP]**.

## 12 REJECTING INTERFERENCE

### NOTCH FILTER (SSB)

Auto Notch filter automatically locates and attenuates any single interfering tone within the receive pass band. This function operates digitally at the IF filter level, hence it can affect your S-meter reading and may also affect (slightly attenuate) your desired signal. However, controlling the AGC level by notching out the strong interfering beat signals could bring up the desired SSB signal that is covered by the interfering beat signal. If the interfering tone is weak, you may find that Beat Cancel eliminates them more effectively.

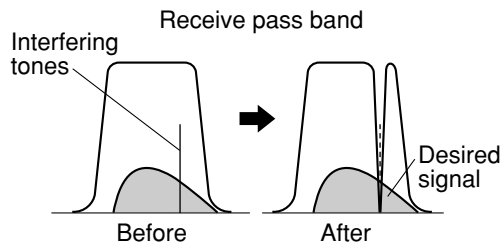

Press **[A.N./ LEVEL]** to toggle the Auto Notch Filter ON and OFF.

- “A.N.” appears when the function is ON.
- The interfering beat signals are notched out.

If the interfering beat signals change the tone frequency randomly, you can adjust the Auto Notch level.

Press **[FUNC], [A.N./ LEVEL]** to access the Auto Notch level adjustment, then turn the **MULTI/ CH** control to select the level from FIX, and 1 to 4. Level 1 is the slowest beat tone tracking speed and Level 4 is the fastest. FIX terminates the beat tone tracking. Adjust this parameter manually to remove the beat signal if necessary.

### AUTO BEAT CANCEL (SSB/ AM)

Auto Beat Cancel uses an adaptive filter and attenuates more than one cyclic interference within the receive pass band. The adaptive filter changes its characteristics according to the nature of the signal being received at any given moment. You can use automatic Beat Cancel when in SSB or AM mode.

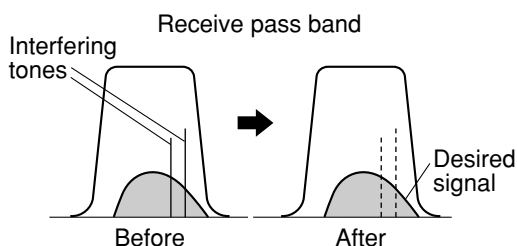

Press **[B.C./ MANUAL]** to toggle between the Auto Beat Cancel ON and OFF.

- “B. C.” appears when the function is ON.
- If desired, you can manually control the beat cancel frequency.

### MANUAL BEAT CANCEL (ALL MODES)

Press **[FUNC], [B.C./ MANUAL]**, then turn the **MANUAL BC** control to select the single Beat Cancel frequency manually. You can select the beat cancel frequency from approx. 300Hz to 3000 Hz by turning the control. Turn the control clockwise to select a higher frequency and counterclockwise to select a lower frequency.

Since the DSP Beat Cancel processes the incoming signals at the AF stage, strong beat signals may control the AGC, then weaken the target signal level. In this case, use the Auto Notch Filter instead, to remove the beat signal from the IF passband filter.

**Note:** While adjusting the **MANUAL BC** control, the transceiver clicks. This is not a malfunction.

### NOISE REDUCTION

#### (N.R. 1: ALL MODES, N.R. 2: SSB/ CW/ FSK/ AM)

This transceiver provides two types of Noise Reduction functions (1 and 2) for reducing random noise which interferes with the desired signal. Trying them both is the easiest way to judge which function works more effectively under the current conditions. Normally, select Noise Reduction 1 (Line Enhanced) in SSB mode and Noise Reduction 2 (SPAC) in CW mode.

Press **[N.R./ LEVEL]** to toggle between Noise Reduction 1, Noise Reduction 2, and OFF.

- “N.R. 1” or “N.R. 2” appears, depending on which function is selected.

#### ■ Setting the N.R. 1 Level Adjustment

The Noise Reduction 1 (Line Enhanced Method) uses an adaptive filter to reduce the noise element from the received signals. When the S/N ratio is reasonably good in SSB, using N.R. 1 will improve the S/N further.

While N.R. 1 is ON, you can further adjust the noise reduction level by pressing **[FUNC], [N.R./ LEVEL]**, then turn the **MULTI/ CH** control to select the level from 1 to 9 or AUTO. The default is AUTO.

#### ■ Setting the N.R. 2 Time Constant

You can change the correlation time for Noise Reduction 2 (SPAC). When in SSB mode, select the correlation time that allows you to hear signals with more clarity. When receiving CW, it is best to select the longest correlation time that allows reliable reception. The longer the correlation time, the better the S/N ratio.

When N.R. 2 is ON, press **[FUNC], [N.R./ LEVEL]**, then turn the **MULTI/ CH** control to select the correlation time from 2 ms to 20 ms. The default is 20 ms.

**Note:**

- ◆ Using Noise Reduction 2 in SSB mode may lower the clarity of signals or induce pulse noise, depending on the conditions.
- ◆ Only Noise Reduction 1 is available for the sub-receiver. However, the level cannot be adjusted.

## NOISE BLANKER

Noise Blanker was designed to reduce pulse noise such as that generated by automobile ignitions. Noise Blanker does not function in FM mode.

Press **[7/ NB/ LEVEL]** to toggle between the Noise Blanker ON and OFF.

- “NB” appears when the function is ON.

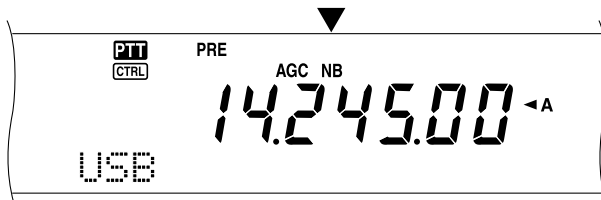

You can further adjust the Noise blanker level from 1 to 10. The default level is 6.

Press **[FUNC]**, **[7/ NB/ LEVEL]**, then turn the **MULTI/ CH** control to adjust the noise blanker level.

- “NB LEVEL” and the current level appear on the sub dot-matrix display.

**Note:** Noise Blanker is available only for the main transceiver in SSB, CW, FSK, and AM modes.

## PRE-AMPLIFIER

Switching the Pre-amplifier OFF may help reduce interference from adjacent frequencies.

Press **[PRE/ LOCK A]** to toggle between the Pre-amplifier ON and OFF.

- “PRE” appears when the function is ON.

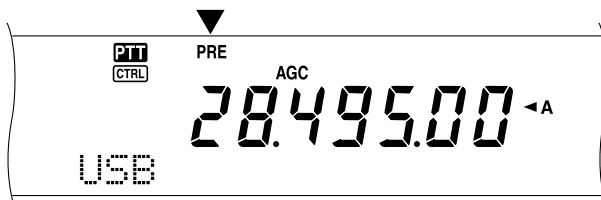

The ON/OFF setting will be automatically stored in the current band. Each time you select the same band, the same setting will be automatically selected.

The frequency range of each band is provided in the following table (under “ATTENUATOR”).

**Note:** If the same frequency (144 MHz or 430 (440) MHz) band is selected on both the main transceiver and the sub-receiver, the pre-amplifier can be switched ON or OFF for both receivers. This is because the main transceiver and sub-receiver share the same antenna.

## ATTENUATOR

The Attenuator reduces the level of received signals. This function is useful when there is strong interference from adjacent frequencies.

Press **[ATT/ F LOCK]** to toggle the Attenuator ON and OFF.

- “ATT” appears when the function is ON.

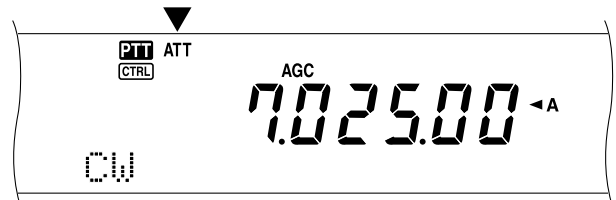

The ON/OFF setting will be automatically stored in the current band. Each time you select the same frequency band, the attenuator setting will be automatically recalled.

The frequency range of each band is shown below.

Frequency Bands (MHz)	Pre-amplifier (Default)	Attenuator (Default)
0.03 ~ 2.5	OFF	OFF
2.5 ~ 4.1	OFF	OFF
4.1 ~ 7.5	OFF	OFF
7.5 ~ 10.5	ON	OFF
10.5 ~ 14.5	ON	OFF
14.5 ~ 18.5	ON	OFF
18.5 ~ 21.5	ON	OFF
21.5 ~ 25.5	ON	OFF
25.5 ~ 30.0	ON	OFF
30.0 ~ 60.0	ON	OFF
118 ~ 300	ON	OFF
300 ~ 512	ON	OFF
1240 ~ 1300	Always ON	Always OFF

**Note:**

- ◆ If the same frequency (144 MHz or 430/ 440 MHz) band is selected on both the main transceiver and the sub-receiver, the attenuator can be switched ON or OFF for both receivers. This is because the main transceiver and sub-receiver share the same antenna.
- ◆ Available receiving frequencies in the above frequency bands vary, depending on the market code. Refer to the Specifications [page 106] for details.
- ◆ If 118 ~ 135.995 MHz, 155 ~ 173.995 MHz or 220 ~ 229.995 MHz is selected for the sub-receiver, the pre-amplifier cannot be turned ON (K-type only).

# MEMORY FEATURES

## MEMORY CHANNELS

The TS-2000(X) provides you with 300 memory channels, numbered 00 to 299, for storing operating frequency data, modes and other information. Memory channels 00 to 289 are called Conventional Memory Channels. Memory channels 290 to 299 are designed for programming VFO tuning ranges and scan ranges. The data you can store is listed below:

Conventional memory is used for storing data you will often recall. For example, you may store the frequency where you regularly meet your club members.

Parameter	Channel 00 ~ 289	Channel 290 ~ 299
RX frequency	Yes	Yes <sup>1</sup>
TX frequency	Yes	(simplex)
RX mode	Yes	Yes <sup>1</sup>
TX mode	Yes	(simplex)
Start/ End frequencies	No	Yes
Offset frequency	Yes	Yes
Shift direction	Yes	Yes
Reverse mode	Yes	Yes
RX frequency step size	Yes	Yes
TX frequency step size	Yes	(simplex)
Tone frequency	Yes	Yes
CTCSS frequency	Yes	Yes
DCS code	Yes	Yes
Tone/ CTCSS/ DCS mode ON/ OFF	Yes	Yes
Memory name	Yes	Yes
Memory Channel Lockout ON/ OFF	Yes <sup>1</sup>	Yes <sup>1</sup>

<sup>1</sup> Changing the data after recalling a memory channel overwrites the contents of the channel.

## STORING DATA IN MEMORY

There are 2 methods used for storing transmit/receive frequencies and associated data in memory channels 00 to 289. Use either method, depending on the relationship of the receive and transmit frequencies you store:

- Simplex channels:  
RX frequency = TX frequency
- Split-frequency channels:  
RX frequency ≠ TX frequency

Memory channels 290 to 299 can also be used as simplex channels.

*Note: When RIT or XIT is ON, the frequency that includes the RIT or XIT offset will be stored.*

### ■ Simplex Channels

- 1 Press **[A/B]** to select VFO A or VFO B.
  - “◀A” or “◀B” appears to show which VFO is selected.
- 2 Select the frequency, mode, etc. to be stored.
- 3 Press **[M.IN]** to enter Memory Scroll mode.

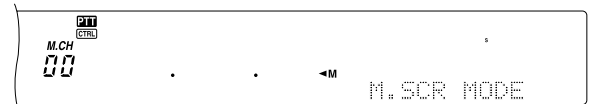

- To exit Memory Scroll mode and abort the storage process, press **[CLR]**.
- 4 Turn the **MULTI/ CH** control, or press Mic **[UP]/ [DWN]** to select a memory channel.
    - You can also select a channel by entering a 3-digit number, such as 012, using the numeric keys.

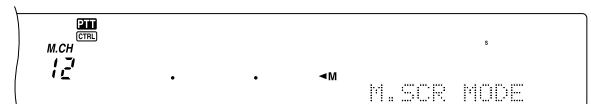

- 5 Press **[M.IN]** again to store the data.
  - The previous data stored in the channel is overwritten.

## ■ Split-Frequency Channels

- 1 Press **[A/B]** to select VFO A or VFO B.
  - “◀A” or “◀B” appears to show which VFO is selected.
- 2 Select the frequency, mode, etc. to be stored.
  - This frequency and mode will be used for transmitting.
- 3 Press **[A/B]** to select the other VFO.
- 4 Select the receive frequency and mode.
- 5 Press **[SPLIT]**.
  - “SPLIT” appears.



- 6 Press **[M.IN]** to enter Memory Scroll mode.



- To exit Memory Scroll mode and abort the storage process, press **[CLR]**.
- 7 Turn the **MULTI/ CH** control, or press Mic **[UP]/ [DWN]** to select a memory channel.
    - You can also select a channel by entering a 3-digit number, such as 012, using the numeric keys.



- 8 Press **[M.IN]** again to store the data.
  - The previous data stored in the channel is overwritten.

**Note:** When subtone frequencies differ between TX and RX while performing memory-VFO split operation, the subtone frequency for TX will be stored in the memory channel.

## MEMORY RECALL AND SCROLL

There are two modes which allow you to retrieve frequencies and associated data that you stored in a memory channel: Memory Recall and Memory Scroll.

### Memory Recall:

In this mode, the transceiver receives and transmits using a frequency that you retrieve. You can temporarily change the frequency and associated data without overwriting the contents of the memory channel when Menu No. 06B is set to ON.

### Memory Scroll:

Use this mode to check the contents of the memory channels without changing the current receive frequency. In this mode, frequencies you retrieve are not used for receiving and transmitting.

## ■ Memory Recall

- 1 Press **[VFO/M]** to enter Memory Recall mode.
  - The memory channel that was last selected appears.

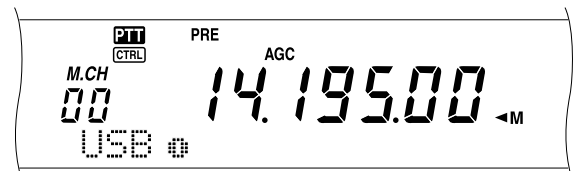

- 2 Turn the **MULTI/ CH** control, or press Mic **[UP]/ [DWN]** to select a memory channel.
  - Continuously holding down Mic **[UP]/ [DWN]** steps the transceiver through the memory channels until the key is released.
  - Memory channels which contain no data are skipped.
  - You cannot change memory channels while transmitting.
- 3 To exit Memory Recall mode, press **[VFO/M]**.

**Note:** Memory channels can also be changed while using the TF-SET function.

## 13 MEMORY FEATURES

### ■ Memory Scroll

- 1 Press **[M.IN]** to enter Memory Scroll mode.
  - The memory channel that was last selected appears.

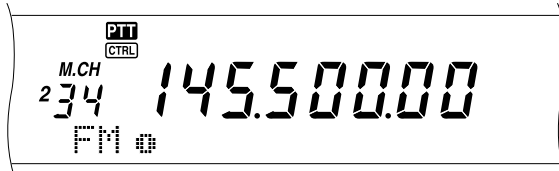

- 2 Turn the **MULTI/ CH** control, or press Mic **[UP]/ [DWN]** to step through the memory channels.
  - You can also change channels by entering a 3-digit number, such as 012, using the numeric keys, then pressing **[ENT]**.
- 3 To exit Memory Scroll mode, press **[CLR]**.
  - The transceiver re-displays the memory channel or VFO frequency that was selected before you activated Memory Scroll.

**Note:** Do not press **[M.IN]** again after entering Memory Scroll mode. Pressing **[M.IN]** results in over-writing the current VFO data to the memory channel you selected.

### ■ Temporary Frequency Changes

After retrieving frequencies and associated data in Memory Recall mode, you can temporarily change the data without overwriting the contents of the memory channel.

- 1 Access Menu No. 06B and select ON.
  - Skip this step when changing only the associated data (not the frequency).
- 2 Recall a memory channel.
- 3 Change the frequencies and associated data.
  - Use only the **Tuning** control to select a frequency.
- 4 If necessary for future use, store the changed data in another memory channel. Refer to “Channel ➔ Channel Transfer” {page 61}.

**Note:** Memory channel data can also be changed while using the **TF-SET** function.

### MEMORY-VFO SPLIT OPERATION

Under “ENHANCED COMMUNICATIONS” {page 31}, you learned about split-frequency operation using two VFOs. Recalling a split-frequency channel is another way to perform split-frequency operation. If you access Menu No. 06A and select ON, you can also use a memory channel and a VFO together for this operation, as follows:

- RX: Memory channel  
TX: VFO A or VFO B
- RX: VFO A or VFO B  
TX: Memory channel

#### To use a memory channel for receiving:

- 1 Access Menu No. 06A and select ON.
- 2 Press **[A/B]** to select the VFO that you will use for transmitting.
  - “◀A” or “◀B” appears to show which VFO is selected.
- 3 Select the frequency for transmitting.
- 4 Recall a memory channel by pressing **[VFO/M]**.
- 5 Turn the **MULTI/ CH** control to select a memory channel to receive.
- 6 Press **[SPLIT]**.
- 7 The VFO A frequency appears on the sub-display. If you want to use the VFO B frequency to transmit, press **[SPLIT]** again.
- 8 Press **[SEND]** or Mic **[PTT]** to transmit on the frequency shown on the sub display.
- 9 Press **[SPLIT]** to exit the SPLIT operation.
  - If Split operation is still selected using VFO A or VFO B, press **[SPLIT]** again to exit Split operation.

#### To use a memory channel for transmitting:

- 1 Access Menu No. 06A and select ON.
- 2 Recall a memory channel by pressing **[VFO/M]**.
- 3 Turn the **MULTI/ CH** control to select a memory channel to transmit.
- 4 Press **[VFO/M]** to return to VFO mode.
- 5 Press **[SPLIT]**. The other VFO frequency appears on the sub display for transmission (Normal SPLIT operation).
- 6 Press **[SPLIT]** again. The memory channel you selected in step 3 appears on the sub-display for transmission.
- 7 Press **[SEND]** or Mic **[PTT]** to transmit on the frequency in the memory channel.
- 8 Press **[SPLIT]** to exit SPLIT operation.

**MEMORY TRANSFER**

**■ Memory → VFO Transfer**

After retrieving frequencies and associated data from Memory Recall mode, you can copy the data to the VFO. This function is useful, for example, when the frequency you want to monitor is near the frequency stored in a memory channel.

- 1 Recall the desired memory channel.
- 2 Press **[M▶VFO/ MG.SEL]**.
  - When a simplex channel is recalled, the data is copied to VFO A or VFO B, depending on which VFO was used to recall the channel.
  - When a split channel is recalled, the RX data is copied to VFO A and the TX data is copied to VFO B.

**Note:**

- ◆ *The Memory Channel Lockout status and the subtone frequency are not copied.*
- ◆ *Pressing **[M▶VFO/ MG.SEL]** after temporarily changing the retrieved data copies the new data to the VFO.*

**■ Channel → Channel Transfer**

You can also copy channel information from one memory channel to another. This function is useful when storing frequencies and associated data that you temporarily change in Memory Recall mode.

- 1 Recall the desired memory channel (page 59).
- 2 Press **[M.IN]** to enter Memory Scroll mode.
  - To exit Memory Scroll mode, press **[CLR]**.
- 3 Select the memory channel where you would like the data copied, using the **MULTI/ CH** control.
- 4 Press **[M.IN]** again.

Channel 00 ~ 289	➔	Channel 00 ~ 289
RX frequency	➔	RX frequency
TX frequency	➔	TX frequency
Mode for RX	➔	Mode for RX
Mode for TX	➔	Mode for TX
Offset frequency	➔	Offset frequency
Shift direction	➔	Shift direction
Reverse ON/ OFF	➔	Reverse ON/ OFF
RX frequency step	➔	RX frequency step
TX frequency step	➔	TX frequency step
Tone frequency	➔	Tone frequency
CTCSS frequency	➔	CTCSS frequency
DCS code	➔	DCS code
Tone/ CTCSS/ DCS ON/ OFF	➔	Tone/ CTCSS/ DCS ON/ OFF
Memory Name	➔	Memory Name
Memory Channel Lockout ON/ OFF	➔	Memory Channel Lockout OFF

Channel 00 ~ 289	➔	Channel 290 ~ 299
RX frequency	➔	TX/ RX frequency (simplex)
TX frequency	➔	
Mode for RX	➔	Mode for TX/ RX (simplex)
Mode for TX	➔	
Offset frequency	➔	Offset frequency
Shift direction	➔	Shift direction
Reverse ON/ OFF	➔	Reverse ON/ OFF
RX frequency step	➔	TX/ RX frequency step (simplex)
TX frequency step	➔	
Tone frequency	➔	Tone frequency
CTCSS frequency	➔	CTCSS frequency
DCS code	➔	DCS code
Tone/ CTCSS/ DCS ON/ OFF	➔	Tone/ CTCSS/ DCS ON/ OFF
Memory Name	➔	Memory Name
Memory Channel Lockout ON/ OFF	➔	Memory Channel Lockout OFF

Channel 290 ~ 299	➔	Channel 00 ~ 289
TX/ RX frequency	➔	RX frequency
	➔	TX frequency
Mode for TX/ RX	➔	Mode for RX
	➔	Mode for TX
Offset frequency	➔	Offset frequency
Shift direction	➔	Shift direction
Reverse ON/ OFF	➔	Reverse ON/ OFF
TX/ RX frequency step (simplex)	➔	RX frequency step
	➔	TX frequency step
Tone frequency	➔	Tone frequency
CTCSS frequency	➔	CTCSS frequency
DCS code	➔	DCS code
Tone/ CTCSS/ DCS ON/ OFF	➔	Tone/ CTCSS/ DCS ON/ OFF
Memory Name	➔	Memory Name
Memory Channel Lockout ON/ OFF	➔	Memory Channel Lockout OFF

When copying a memory channel 290 ~ 299 ➔ channel 290 ~ 299, Memory Channel Lockout status changes to OFF, regardless of the original channel settings.

The tables above illustrate how data is transferred between memory channels.

## 13 MEMORY FEATURES

### STORING FREQUENCY RANGES

Memory channels 290 to 299 allow you to store frequency ranges for VFO tuning and Program Scan. Program Scan is described in the next chapter. To tune or scan frequencies within a specified range, store the start and end frequencies for that range in advance.

- 1 Press **[A/B]** to select VFO A or VFO B.
- 2 Select the desired start frequency.
- 3 Press **[M.IN]** to enter Memory Scroll mode.
  - To exit Memory Scroll mode and abort the storage process, press **[CLR]**.

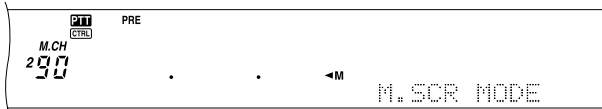

- 4 Turn the **MULTI/ CH** control, or press Mic **[UP]/ [DWN]** to select a memory channel in the range of 290 to 299.
  - You can also select a channel by entering a 3-digit number, such as 290, using the numeric keys.
- 5 Press **[M.IN]** to store the start frequency in the memory channel.
  - "CLOSE INPUT" appears on the sub dot-matrix display.



- 6 Turn the **Tuning** control or the **MULTI/ CH** control to select the end frequency.
- 7 Press **[M.IN]** to store the end frequency in the memory channel.
  - The previous data stored in the channel is overwritten.

#### ■ Confirming Start/End Frequencies

Use this procedure to check the start and end frequencies that you stored in channels 290 to 299.

- 1 Press **[VFO/M]** to enter Memory Recall mode.
- 2 Turn the **MULTI/ CH** control, or press Mic **[UP]/ [DWN]** to select a memory channel from 290 to 299.
- 3 Press **[-]** to check the start frequency and **[+]** to check the end frequency.

#### ■ Programmable VFO

Using the start and end frequencies that you stored in channels 290 to 299, Programmable VFO restricts the frequency range that you can tune with the **Tuning** control. One application of this function is to help you operate within the authorized frequency limits of your license.

- 1 Press **[VFO/M]** to enter Memory Recall mode.
- 2 Turn the **MULTI/ CH** control, or press Mic **[UP]/ [DWN]** to select a memory channel from 290 to 299.

Now you can only tune from the start frequency to the end frequency, using the **Tuning** control.

*Note: Pressing Mic **[UP]/ [DWN]** or turning the **MULTI/ CH** control results changing the memory channel number while in Programmable VFO mode.*

### Memory Channel Lockout

You can lock out memory channels that you prefer not to monitor during Memory Scan. Memory Scan is described in the next chapter (page 68).

- 1 Press **[VFO/M]** to enter Memory Recall mode.
- 2 Turn the **MULTI/ CH** control, or press Mic **[UP]/ [DWN]** to select the memory channel.
- 3 Press **[CLR]** momentarily.
  - Pressing **[CLR]** for more than approximately 2 seconds erases the contents of the memory channel.
  - A dot appears beside the right-most digit of the memory channel number to indicate the channel has been locked out.

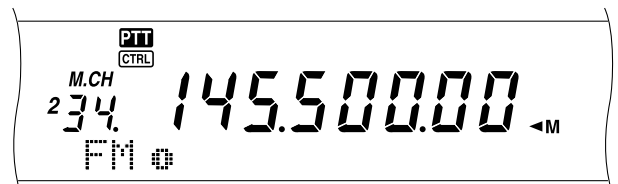

- Repeatedly pressing **[CLR]** toggles between adding and removing the channel from the scan list.

### ERASING MEMORY CHANNELS

If there are memory channels that you will not recall in the future, you may prefer erasing the contents of those channels.

- 1 Press **[VFO/M]** to enter Memory Recall mode.
- 2 Turn the **MULTI/ CH** control, or press Mic **[UP]/ [DWN]** to select the memory channel.
  - You can also select a channel by entering a 3-digit number, such as 012, using the numeric keys.
- 3 Press and hold **[CLR]** for approximately two seconds.
  - A long beep sounds to confirm that the channel data has been erased.



**MEMORY CHANNEL NAME**

You can assign a name to each memory channel. A maximum of 7 alpha-numeric characters can be stored.

- 1 Press **[M.IN]** to enter Memory Scroll mode.
- 2 Turn the **MULTI/ CH** control, or press Mic **[UP]/ [DWN]** to select a memory channel.
- 3 Press **[DISP]**.

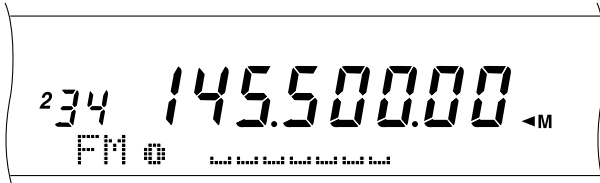

- 4 Press **[+]/ [-]** or turn the **MULTI/ CH** control to select the desired alpha-numeric character. You can move the cursor to the left by pressing **[MAIN]**, or to the right by pressing **[SUB]**. Or, you can use an optional DTMF microphone to enter alpha-numeric characters.

*Note: Alpha-numeric entries are limited to those characters shown in the following DTMF character table when you are using a DTMF Mic.*

- 5 After selecting all the necessary characters for the memory channel name, press **[M.IN]** to store the name, or press **[DISP]** to select a Memory Group. You can select only one of 10 groups (0 to 9). Enter the desired group number by pressing a numeric key. The selected group is shown in a larger font. After selecting a group, press **[M.IN]** to store the name and group number in the memory channel.
- 6 When you recall a memory channel with a name, the name is displayed on the dot-matrix display along with the memory channel number and group number {page 64}.

**Alpha-numeric characters**

Available characters									
A	B	C	D	E	F	G	H	I	J
K	L	M	N	O	P	Q	R	S	T
U	V	W	X	Y	Z	[	\	]	^
_	`	a	b	c	d	e	f	g	h
i	j	k	l	m	n	o	p	q	r
s	t	u	v	w	x	y	z	{	
}	~	SP	!	"	#	\$	%	&	'
(	)	*	+	,	-	.	/	0	1
2	3	4	5	6	7	8	9	:	;
<	=	>	?	@					
Additional characters for all E-types									
À	Á	Â	Ã	Ä	Å	Æ	Ç	È	É
Ê	Ë	Ì	Í	Î	Ï	Ð	Ñ	Ò	Ó
Ô	Õ	Ö	Š	Ø	Ù	Ú	Û	Ü	Ý
Š	ß	Œ	à	á	â	ã	ä	å	æ
ç	è	é	ê	ë	ì	í	î	ï	ð
ñ	ò	ó	ô	õ	ö	œ	ø	ù	ú
û	ü	ý	ÿ	ÿ					

**Available characters using a DTMF Mic**

DTMF key	Available characters						
1	q	z	1	Q	Z		
2	a	b	c	2	A	B	C
3	d	e	f	3	D	E	F
4	g	h	i	4	G	H	I
5	j	k	l	5	J	K	L
6	m	n	o	6	M	N	O
7	p	r	s	7	P	R	S
8	t	u	v	8	T	U	V
9	w	x	y	9	W	X	Y
0	space	0					
#	?	!	'	.	,	-	/
	&	#	(	)	<	>	;
	:	"	@				
*	No function						
A	Move the cursor right						
B	Move the cursor left						
C	Delete the selected character						
D	Same as <b>[M.IN]</b> key						

## 13 MEMORY FEATURES

### MEMORY GROUP

To manage 300 memory channels, you can divide them up into a maximum of 10 groups (Groups 0 to 9). After you configure a Memory Group, you can select one or more of the Memory Groups you want to recall, in Memory Recall mode. As a default, all memory channels are stored in Group 0.

To change the Memory Channel Group:

- 1 Press **[M.IN]** to enter Memory Scroll mode.
- 2 Select the desired memory channel for which you want to change the Memory Group by turning the **MULTI/ CH** control.
- 3 Press **[DISP]**.
  - The Memory Name input prompt appears.
- 4 Press **[DISP]** again to skip the input or enter a Memory Name using **[+]/ [-]** and **[MAIN]** or **[SUB]** {page 63}.
  - The current Memory Group appears in a larger font.



- 5 Press a numeric key to change the selected Group number. The newly selected Group number appears in a larger font.
- 6 Press **[M.IN]** to store the settings.

#### ■ Memory Group Select

After you configure Memory Groups to the Memory Channels, you can select one or more of the Groups to be recalled in Memory Recall mode.

To select Memory Groups:

- 1 Press **[FUNC]**, **[M▶VFO/ MG.SEL]** to enter Memory Group Select mode.
- 2 Numbers 0 ~ 9 appear in the main dot-matrix display. The selected Memory Group numbers are displayed in larger fonts. To change the selection, press a numeric key. To select all the Memory Groups, press **[▼/ DCS/SEL]**. At least, one Memory Group must be selected.

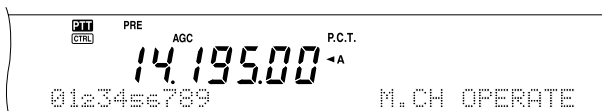

- 3 Press **[M.IN]** to save the setting and exit.
- 4 You can now recall only the selected Memory Groups in Memory Recall mode.

### QUICK MEMORY

Quick memory is designed to quickly and temporarily save data without specifying a particular memory channel. Use Quick memory to store data you will not use in future operating sessions. For example, as you tune across the band looking for DX, it is convenient to store stations that you want to contact. You can quickly jump between several different memory channels as you monitor them.

This transceiver provides ten Quick memory channels ("0\_" to "9\_") that can store the following data:

VFO A frequency and operating mode	VFO B frequency and operating mode
Sub-receiver ON/ OFF	Sub-receiver frequency and operating mode
RIT ON/ OFF	XIT ON/ OFF
RIT/ XIT offset frequency	Receiver filter bandwidth
Noise Blanker ON/ OFF	FINE ON/ OFF
DSP Noise Reduction OFF/ 1/ 2	DSP Beat Cancel ON/ OFF
DSP Auto Notch ON/ OFF	TX/ RX functions

### STORING INTO QUICK MEMORY

Each time you store a new frequency, all previously stored frequencies are bumped to the next respective Quick memory channel. When all ten memory channels contain frequencies, storing one more frequency bumps the contents of memory channel 9 off the stack (the data is lost).

The following diagram illustrates how the Quick Memory stacks the data in memory each time you press **QUICK MEMO [M.IN]**.

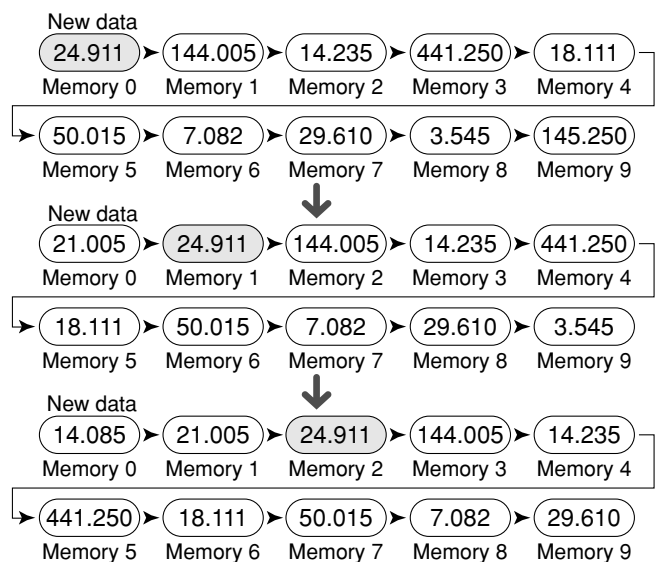

**Note:** To use the Quick memory channels, you must operate both the main transceiver and the sub-receiver in VFO mode. If you are using the Quick memory channels while the sub-receiver is turned off, its last operating mode must be VFO mode. Turning the sub-receiver off while it is recalling a memory channel will not allow you to use the Quick memory function.

You can store data in the Quick Memory only when you operate both the main transceiver and the sub-receiver in VFO mode.

- 1 Select the frequency, mode, etc. on the main transceiver or sub-receiver VFO.
- 2 Press **QUICK MEMO [M.IN]**.
  - Each time **QUICK MEMO [M.IN]** is pressed, the current VFO data is written to the Quick Memory.

**Note:** When *RIT* or *XIT* is ON, this ON status and the offset will also be stored.

## RECALLING QUICK MEMORY CHANNELS

You can recall a Quick Memory channel only when you operate both the main transceiver and the sub-receiver in VFO mode.

- 1 Press **QUICK MEMO [MR]**.
  - The current memory channel number appears.

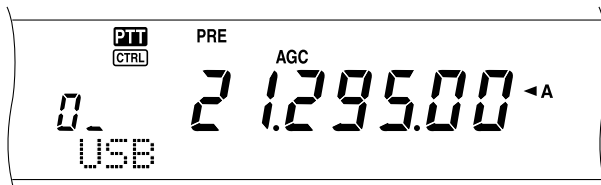

- If there is no data stored in any Quick memory channel, the data cannot be recalled to the current VFO, an error beep sounds.
- 2 Turn the **MULTI/ CH** control to select a Quick memory channel (0 to 9).
    - You cannot change memory channels while transmitting.
  - 3 To exit, press **QUICK MEMO [MR]** again.

**Note:** Memory channels cannot be changed while using the *TF-SET* function.

## TEMPORARY FREQUENCY CHANGES

After recalling a Quick memory channel, you can temporarily change the data without overwriting the contents of the channel. You can change the frequency even when you select OFF in Menu No. 06B.

- 1 Press **QUICK MEMO [MR]**.
- 2 Turn the **MULTI/ CH** control to select a Quick memory channel (0 to 9).
- 3 Change the frequencies and associated data.
- 4 To store the changed data in the Quick memory, press **QUICK MEMO [M.IN]**.
  - This action stores the new data in the current channel and bumps the old frequency to the next higher Quick memory channel.
- 5 To exit, press **QUICK MEMO [MR]** again.

**Note:** Memory channel data can also be changed while using the *TF-SET* function.

## QUICK MEMORY → VFO TRANSFER

This function copies the contents of the recalled memory channel to the VFO.

- 1 Recall a Quick Memory channel.
- 2 Press **[M▶ VFO/ MG.SEL]**.

**Note:** Pressing **[M▶ VFO/ MG.SEL]** after temporarily changing the recalled data copies the new data to the VFO.

Scan is a useful function for hands-off monitoring of your favorite frequencies. By becoming comfortable with all types of Scan, you will increase your operating efficiency.

This transceiver provides the following types of scans.

Scan Type		Purpose
Normal Scan	VFO Scan	Scans the entire band of the frequency you selected
	Program Scan	Scans the specific frequency ranges stored in Memory channels 290 ~ 299
	MHz Scan	Scans the frequencies within a 1 MHz range
Memory Scan	All-Channel Scan	Scans all Memory channels, from 00 to 299
	Group Scan	Scans the specific Memory channel groups
Call Scan	VFO	Scans the Call channel and the current VFO frequency
	Memory Channel	Scans the Call channel and the selected Memory channel
Visual Scan*	VFO	Scans the current operating frequency as well as a specified number of frequencies above and below that frequency. The signal strength of each channel is displayed in a bar-graph
	Memory Channel	Scans the Memory channels and displays the signal strength of each channel in a bar-graph

\* Visual Scan graphically shows how frequencies in a specific range are busy.

#### Note:

- ◆ While using CTCSS or DCS, Scan stops only for the signals that contain the same CTCSS tone or DCS code that you selected.
- ◆ When using S-meter Squelch, Scan stops when the received signal strength matches or exceeds the S-meter setting. Scan resumes 2 seconds after the signal level drops below the S-meter setting.
- ◆ Pressing and holding Mic [PTT] causes Scan to stop if it is functioning on a non TX band. Pressing Mic [PTT] on the scanning band causes Scan to stop.
- ◆ Starting Scan switches OFF the Automatic Simplex Checker.

## NORMAL SCAN

When you are operating the transceiver in VFO mode, 2 types of scanning are available.

- VFO Scan

The transceiver scans the entire band of the frequency you selected. For example, if you are operating and receiving on the main transceiver's VFO A at 14.195.00 MHz, it scans all the frequencies in the range of 30.00 kHz to 60.00000 MHz. (Refer to VFO frequency range in the Specifications.)

- Program Scan

By programming the start and end frequency in Memory channels 290 ~ 299 {page 62}, you can limit the scanning frequency range. Since there are 10 memory channels (290 ~ 299) available for specifying the start and end frequency, you can select one or more (a maximum of 10) ranges to scan. This is useful when you are waiting for a DX station on a certain frequency but the station may appear on slightly higher or lower frequency.

## VFO SCAN

VFO Scan scans the entire frequency range that is available for the current VFO. When the Program Scan frequency range is not programmed or no Scan Group is selected for the Program Scan, the transceiver also scans the entire frequency range available for the current VFO.

If one or more Program Scan frequency ranges are programmed in memory channels 290 to 299:

- 1 Press [FUNC], [SCAN/ SG.SEL].
- 2 If one or more memory channels are selected for the Program Scan, the selected channels are displayed in a larger font on the main dot-matrix display.



In this case, press [V/ DCS/SEL] to temporarily deselect all the channels. When there are no Scan Group channels selected, "VFO SCN MODE" appears on the sub dot-matrix display.

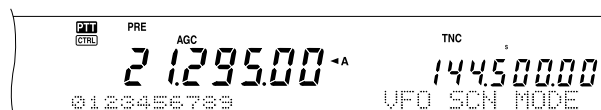

- 3 Press [SCAN/ SG.SEL] to return to the current VFO mode.
- 4 Press [SCAN/ SG.SEL] to start the VFO Scan.

#### Note:

- ◆ While scanning, you can change the scan speed by turning the RIT/ SUB control. Turn the control clockwise/ counterclockwise to decrease/ increase the scan speed. The speed indicator appears on the main dot-matrix display, where P1 is the fastest speed and P9 is the slowest.
- ◆ You cannot change the VFO Scan speed in FM mode.
- ◆ You cannot change the VFO Scan speed on the sub-receiver.

## PROGRAM SCAN

Program Scan monitors the range between the start and end frequencies that you have stored in Conventional memory channels 290 to 299. Refer to "STORING FREQUENCY RANGES" {page 62} for details on how to store the start and end frequencies.

You can select a maximum of 10 memory channels (Memory channels 290 to 299) and sequentially scan the ranges that you stored in these channels. Program Scan starts with the smallest channel number and repeats the sequence as described below.

- 1 Press **[A/B]** to select VFO A or VFO B.
  - If you are operating the sub-receiver, press **[VFO/M]** to select VFO mode.
- 2 Press **[FUNC]**, **[SCAN/ SG.SEL]**.



- 3 If no Program scan channel is selected, all memory channel numbers (from 290 to 299) are displayed in small fonts. Only the one's digit of each memory channel is displayed on the main dot-matrix display. 0 represents channel 290, 1 represents channel 291, 2 represents channel 292, etc.
- 4 To select the Program scan frequency range, press a numeric key 0 to 9. For example, press **[3]** for channel 293 only or press **[3]**, **[5]**, **[7]** to select channels 293, 295, and 297. When a channel is selected for the Program Scan, the number is displayed in a larger font.

To temporarily deselect all the channels (290 to 299) so that you can perform the VFO Scan, press **[V/ DCS/SEL]** (Refer to "VFO SCAN" on page 66).

### Note:

- ◆ At least one of the valid Program Scan channels (from 290 to 299) must be programmed and selected to perform the Program Scan. If no Program channel is selected or available for the Program Scan, the transceiver performs the VFO Scan.
- ◆ When performing the Program Scan on the sub-receiver, the frequencies must be within the sub-receiver frequency range limitations. Otherwise, the Program Scan cannot be performed. The same conditions apply to the main transceiver.



- 5 Press **[SCAN/ SG.SEL]** to start the Program Scan.
  - To quickly move towards a desired frequency while scanning, turn the **Tuning** control or the **MULTI/ CH** control, or press Mic **[UP]/ [DWN]**.
  - When in a mode other than FM mode, turning the **RIT/ SUB** control clockwise decreases the scan speed, and counterclockwise increases the speed. The current scan speed is shown on the display; P1 is the fastest speed and P9 is the slowest.

- While in FM mode, Scan automatically stops on a frequency where a signal is present. The transceiver will either remain on that channel for a short time (Time-operated mode) or until the signal drops out (Carrier-operated mode), depending on which mode you select via Menu No. 10 {page 68}.

- 6 To stop Scan, press **[SCAN/ SG.SEL]** or **[CLR]**.

### Note:

- ◆ If you are operating on the sub-receiver and perform the Program Scan, the sub-receiver automatically skips the memory channels that cannot be scanned on the sub-receiver. The same conditions also apply to the main transceiver.
- ◆ If you have turned the **MAIN SQL** or **SUB SQL** control clockwise, far beyond the squelch threshold when in FM mode, Scan may fail to stop at a channel where a signal is present. If this happens, turn the **MAIN SQL** or **SUB SQL** control slightly counterclockwise.
- ◆ If you press **[SCAN/ SG.SEL]** before storing any frequency range for memory channels 290 to 299, the transceiver starts VFO scan.
- ◆ When the current receive frequency is within one of the ranges that you selected with channel numbers, Scan starts with the current frequency. The operating mode stored in the memory channel is used.
- ◆ When the current receive frequency is outside all the ranges that you selected with the channel numbers, Scan starts with the start frequency stored in the smallest channel number.
- ◆ The operating mode can be changed while scanning, but the memory channel is overwritten with the changed mode.
- ◆ When the current Scan range is smaller than a single step of the **MULTI/ CH** control, turning the control clockwise causes Scan to jump to the start frequency, and counterclockwise to the end frequency.
- ◆ Starting Program Scan switches OFF the RIT and XIT functions.
- ◆ While in FM mode, the Program Scan monitors rounded off frequencies regardless of the Menu No. 04 setting.
- ◆ You cannot change the scan speed on the sub-receiver.

## PROGRAM SCAN PARTIALLY SLOWED

You can specify a maximum of 5 frequency points for each memory channel from 290 to 299 so that the Program Scan slows down the scanning speed. To specify the slow down frequency points, first program the start and end frequencies into a memory channel (290 ~ 299) {page 62}.

- 1 Access Menu No. 07 to confirm that the function is ON (default is ON).
- 2 You can further configure the slow down frequency width. Access Menu No. 08 to select the range from 100 Hz to 500 Hz (default is 300 Hz).

**Note:** If you select, for example, 500 Hz for Menu No. 08, the Program Scan slows down to a  $\pm 500$  Hz width, centering the frequency you marked below.

- 3 Press **[VFO/M]** to recall the memory channel (290 ~ 299) for which you want to specify the scan slow down frequencies.
- 4 Press **[-]/ [+]** to confirm the start (**[-]**) or end (**[+]**) frequency.
- 5 Turn the **Tuning** control to the center frequency point that you want the Program Scan to slow down. Press **QUICK MEMO [M.IN]** to mark the Slow down frequency point. The "★" icon appears.

## 14 SCAN

- Repeat step 5 to specify the center slow down frequency points. You can specify a maximum of 5 frequency points for each channel.
- If you want to clear the slow down frequency points that you previously stored, press and hold **QUICK MEMO [M.IN]** for 1 second. A confirmation beep sounds and the transceiver clears all the slow down frequency points you specified in the memory channel.

**Note:** You must clear all the previous slow down frequency points; you cannot clear only specific points.

- Press **[VFO/M]** to return to VFO mode.
- Press **[SCAN/ SG.SEL]** to start the Program Scan with the slow down frequency point(s).

**Note:**

- During the Program Scan, you can turn the **RIT/ SUB** control to adjust the scanning speed. Turn the control clockwise/ counter-clockwise to slow down/ speed up the scan. The Program Scan speed indicator appears on the main dot-matrix display during the Program Scan; P1 is the fastest speed and P9 is the slowest.
- You cannot change the Program Scan speed in FM mode.
- You cannot change the scan speed on the sub-receiver.
- You cannot specify the Program Scan slow down frequency point for FM mode.

### SCAN HOLD

This function stops Program Scan for approximately 5 seconds, then resumes Scan when you jump to the desired frequency by turning the **Tuning** control or the **MULTI/ CH** control, or by pressing Mic **[UP]/ [DWN]**.

To use this function, access Menu No. 09, and select ON. The default is OFF.

### MHz SCAN

When you operate the main transceiver or sub-receiver in VFO mode, you can scan an entire 1 MHz frequency range within the current VFO frequency.

- Press **[VFO/M]** to select VFO mode.
- Select the desired frequency to perform the MHz Scan. If you want to scan the entire 145 MHz frequency, for example, select 145.650 MHz. Scan will operate between 145.00000 MHz and 145.99999 MHz.
- Press and hold **[1MHz/ SEL]** to start the MHz Scan.
- Turn the **RIT/ SUB** control to adjust the scan speed.
- To stop the MHz Scan, press **[SCAN/ SG.SEL]** or **[CLR]**.

**Note:**

- You cannot change the MHz Scan speed in FM mode.
- You cannot change the scan speed on the sub-receiver.

### MEMORY SCAN

Memory Scan monitors all memory channels in which you have stored frequencies (All-channel Scan) or only a desired group of memory channels (Group Scan).

Scan automatically stops at a channel where a signal is present, regardless of the operating mode. The transceiver will either remain on that channel for a short time (Time-operated mode) or until the signal drops out (Carrier-operated mode). Use Menu No. 10 to select either mode. The default is Time-operated.

### SCAN RESUME METHOD

The transceiver stops scanning at the frequency (or memory channel) where a signal is detected. It then continues scanning according to which resume mode you have selected. You can choose one of the following modes. The default is Time-operated mode.

- Time-Operated mode**

The transceiver remains on a busy frequency (or memory channel) for approximately 6 seconds, then continues to scan, even if the signal is still present.

- Carrier-Operated mode**

The transceiver remains on the busy frequency (or memory channel) until the signal drops out. There is a 2 second delay between signal dropout and scan resumption.

- Press **[MENU]** to enter Menu mode.
- Turn the **MULTI/ CH** control to select Menu No. 10.
- Press **[+]/ [-]** to select TO (Time-Operated) or CO (Carrier-Operated).



- Press **[MENU]** to complete the setting and exit Menu mode.

You can lock out the memory channels that you prefer not to monitor while scanning. To do this, refer to "Memory Channel Lockout" {page 62}.

### ALL-CHANNEL SCAN

Use the following procedure to scan all the memory channels that contain frequency data in sequence, ignoring the Memory Group number.

- Select Time-operated or Carrier-operated mode via Menu No. 10.
- Press **[VFO/M]** to enter Memory Recall mode.
- Turn the **MAIN SQL** or **SUB SQL** control to adjust the squelch threshold.
- Press **[FUNC]**, **[SCAN/ SG.SEL]** to enter Scan Group Select mode.
  - The selected Groups appear in a larger font.
- Press **[•/ DCS/SEL]** to deselect all Groups so that the transceiver scans the memory channel sequentially, ignoring the Memory Group number data.

- 6 Press **[SCAN/ SG.SEL]** to return to Memory Recall mode.
- 7 Press **[SCAN/ SG.SEL]** to start All-channel Scan.
  - Scan starts from the current memory channel and ascends up through the channel numbers (scan direction cannot be changed).
  - To jump to a desired channel while scanning, turn the **MULTI/ CH** control, or press Mic **[UP]/ [DWN]**.
- 8 To stop Scan, press **[SCAN]** or **[CLR]**.

**Note:**

- ◆ *If you are operating on the sub-receiver and perform the Memory Scan, the transceiver automatically skips the memory channels that cannot be received by the sub-receiver. The same conditions apply to the main transceiver.*
- ◆ *If you have turned the **MAIN SQL** or **SUB SQL** control clockwise, far beyond the squelch threshold, Scan may fail to stop at a channel where a signal is present. If this happens, turn the **SQL** control slightly counterclockwise.*
- ◆ *Starting Memory Scan switches OFF the RIT and XIT functions.*

**GROUP SCAN**

For the purpose of Group Scan, the 300 memory channels can be divided into 10 groups so that you can select one or more groups to be scanned, depending on the situation.

When you store frequency data in a memory channel {page 58}, the transceiver automatically adds the default Group 0 (zero), to the memory channel data.

To recall the existing memory channel data and revise the Group number:

- 1 Press **[M.IN]** to enter Memory Scroll mode.
- 2 Select the desired memory channel by turning the **MULTI/ CH** control.
- 3 Press **[DISP]**.
  - The Memory Name input prompt appears. Press **[DISP]** again to skip the input or enter a Memory Name using **[+]/ [-]** and **[MAIN]** or **[SUB]** {page 63}.
- 4 Press the desired Group number (**[0]** to **[9]**) using the numeric keypad. The selected Group number appears in a larger font.

**Note:** *You can select only one of 10 groups (0 to 9) for each memory channel.*

- 5 Press **[M.IN]** to store and overwrite the new channel data to the memory channel.
- 6 Repeat steps 2 through 6 for each memory channel you want to assign to a specific group.



You can select a maximum of 10 groups and sequentially scan the channels that belong to those groups. Group Scan starts with the smallest group number and repeats the sequence, for example, group 3 → group 5 → group 7 → group 3.

- 1 Select Time-operated or Carrier-operated mode via Menu No. 10.
- 2 Press **[VFO/M]** to enter Memory Recall mode.
- 3 Turn the **MAIN SQL** or **SUB SQL** control to adjust the squelch threshold.
- 4 Press **[FUNC]**, **[SCAN/ SG.SEL]** to enter Scan Group Select mode. Then, using the numeric keypad, enter the group numbers you want to scan. i.e.- Press **[3]** for group 3, or press **[3]**, **[5]**, **[7]** for groups 3, 5, and 7. The selected Memory Groups appear in a larger font.
- 5 Press **[SCAN/ SG.SEL]** to exit Scan Group Select mode.
- 6 Press **[SCAN/ SG.SEL]** again to start Memory Group Scan.
  - Scan ascends up through the channel numbers (scan direction cannot be changed).
  - To jump to a desired channel while scanning, turn the **MULTI/ CH** control or press Mic **[UP]/ [DWN]**.
- 7 To stop Scan, press **[SCAN/ SG.SEL]** or **[CLR]**.

After using Group Scan, press **[FUNC]**, **[SCAN/ SG.SEL]**, then **[\*/ DCS/SEL]** to deselect all the Group numbers you selected in step 4. This returns you to All-channel Scan (factory default).

**Note:**

- ◆ *If you are operating on the sub-receiver and perform the Group Scan, the transceiver automatically skips the memory channels that cannot be received by the sub-receiver. The same conditions apply to the main transceiver.*
- ◆ *If you have turned the **MAIN SQL** or **SUB SQL** control clockwise, far beyond the squelch threshold, Scan may fail to stop at a channel in which a signal is present. If this happens, turn the **SQL** control slightly counterclockwise.*
- ◆ *When the current channel is within one of the groups that you selected, Scan starts with the current channel.*
- ◆ *When the current channel is outside all the groups that you selected, Scan starts with the group number that is larger than and closest to the group number of the current channel.*
- ◆ *Starting Memory Scan switches OFF the RIT and XIT functions.*

**CALL SCAN**

A Call channel can be stored for each operating band, such as HF, 50 MHz, 144 MHz, 430/ 440 MHz and 1.2 GHz (TS-2000 Optional) bands. You can monitor one of these Call channels and the current operating frequency alternatively.

- 1 Select the frequency you want to monitor.
  - In VFO mode, press **[A/B]** to select VFO A or B for the main transceiver or press **[SUB]** or **[CTRL]** to select the sub-receiver VFO. Then, turn the **Tuning** control or the **MULTI/ CH** control to select the desired frequency.
  - In Memory Recall mode, press **[VFO/M]** to select the memory channel you want to monitor by turning the **MULTI/ CH** control.
- 2 Press **[CALL/ C.IN]** to recall the Call channel for the frequency band.

## 14 SCAN

- 3 Press **[SCAN/ SG.SEL]**.
- 4 The Call channel and the selected VFO frequency or memory channel are monitored alternatively.
- 5 To stop Scan, press **[SCAN/ SG.SEL]** or **[CLR]**.

### VISUAL SCAN

While you are receiving, Visual Scan allows you to monitor frequencies near the current operating frequency. Visual Scan graphically displays how all frequencies in the selected range are busy. You will see a maximum of 7 segments, for each frequency (channel) point that represent relative S-meter levels.

Determine the scan range by selecting the center frequency and the number of channels. The default number of channels is 61.

#### ■ Using Visual Scan (VFO)

- 1 Select the desired band for Visual Scan.
- 2 Turn the **Tuning** control, or press Mic **[UP]/ [DWN]**, to select the operating frequency.
  - This frequency will be used as the center frequency.
- 3 Press and hold **[DISP]** for approximately 1 second to start Visual Scan (VFO).



- The center frequency is displayed on the main frequency display and the current scanning frequency is displayed on the sub frequency display. The operating mode and the number of channels to be scanned are displayed on the main dot-matrix display. The sub dot-matrix display shows the relative S-meter level of each frequency point, vertically.



- To pause Scan, press **[DISP]**. "P" appears on the main dot-matrix display. While the Visual Scan is paused, you can monitor the paused frequency. Press **[DISP]** again to resume the Visual Scan.
- 4 To change the current scanning frequency, turn the **Tuning** control or press Mic **[UP]/ [DWN]**.
    - The displayed frequency changes and the cursor moves.
    - Press **[1MHz/ SEL]** to make the current scanning frequency the new center frequency.
    - You can move the frequency using the **Tuning** control. If you want to revert to the original center frequency, press **[FM/ AM/ NAR]**.
  - 5 To quit Visual Scan, press **[CLR]** or **[SCAN/ SG.SEL]**.

#### ■ Changing the Number of Channels to Scan

- 1 Press **[MENU]** to enter Menu mode.
- 2 Turn the **MULTI/ CH** control to select Menu No. 11.
- 3 Press **[+]/ [-]** to select 31, 61 (default), 91 or 181 channels for the number of channels to scan.



- 4 Press **[MENU]** to exit Menu mode.

#### Note:

- ◆ The current frequency step of the **MULTI/ CH** control is used for the Visual Scan.
- ◆ While performing the Visual Scan, the **DUAL WATCH** function (page 47) is temporarily disabled unless you are using the 144 MHz or 430/ 440 MHz in FM or AM mode and the Control Band for the main transceiver.
- ◆ If you start the Visual Scan from the frequency on the sub-receiver, the frequency is transferred to the main display, then the Visual Scan starts.
- ◆ If you start the Visual Scan in Memory Recall mode, the memory channel frequencies will be scanned.
- ◆ Visual Scan stops when you transmit.
- ◆ Depending on the transceiver conditions, Visual Scan and the S-meter level may differ.

#### ■ Using Visual Scan (Memory Channel)

- 1 Press **[MENU]** to enter Menu mode.
- 2 Turn the **MULTI/ CH** control to select Menu No. 11.
- 3 Press **[+]/ [-]** to select 31, 61 (default), 91 or 181 channels for the number of channels to scan.
- 4 Press **[VFO/M]** to enter Memory Recall mode.
- 5 Press and hold **[DISP]** for approximately 1 second to start Visual Scan (Memory Channel).



- The center memory channel number is displayed on the main frequency display and the current scanning frequency is displayed on the sub frequency display. The operating mode of the center memory channel and the number of channels to be scanned are displayed on the main dot-matrix display. The sub dot-matrix display shows the relative S-meter level of each frequency point, vertically.



- To pause Scan, press **[DISP]**. "P" appears on the main dot-matrix display. While the Visual Scan is paused, you can monitor the paused frequency. Press **[DISP]** again to resume the Visual Scan.



- 6** To change the current scanning frequency, turn the **MULTI/ CH** control or press Mic **[UP]/ [DWN]**.
  - The displayed memory channel number changes and the cursor moves.
  - Press **[1MHz/ SEL]** to make the current scanning frequency the new center scanning channel.
- 7** To quit Visual Scan, press **[CLR]** or **[SCAN/ SG.SEL]**.

# OPERATOR CONVENIENCES

## ALT (Auto Lock Tuning)

The ALT (Auto Lock Tuning) allows the transceiver to adjust the center receiving frequency automatically when you operate on the 1.2 GHz band in FM mode. When the receiving audio signal is distorted or breaking up, turn this function on to adjust the center receiving frequency. Some old 1.2 GHz transceivers do not have stable and precise oscillating circuits and tend to be slightly off (drifted from) the displayed frequency.

Press **[FUNC]**, **[XIT/ ALT]** to toggle between the ALT function ON or OFF.

- “ALT” appears when the function is ON.

**Note:** The ALT (Auto Lock Tuning) works only on the 1.2 GHz band in FM mode.

## ANTENNAS

### HF/ 50 MHz Band

Two antenna connectors are available for the HF/ 50 MHz band on the rear panel {page 13}. When you operate the main transceiver on these frequencies, you can select one of 2 antennas.

Press **[FUNC]**, **[AT/ ANT1/2]** to select ANT 1 or ANT 2 for the main transceiver.

- “ANT1” or “ANT 2” appears to indicate which antenna is selected.

The ANT 1/ANT 2 setting will automatically be stored in the antenna band memory. Next time you select the same band, the same antenna will be automatically selected.

Antenna Selection Frequency Range (MHz)	
0.03 ~ 2.5	2.5 ~ 4.1
4.1 ~ 7.5	7.5 ~ 10.5
10.5 ~ 14.5	14.5 ~ 18.5
18.5 ~ 21.5	21.5 ~ 25.5
25.5 ~ 30.0	30.0 ~ 60.0

**Note:** Connect an external antenna tuner to the ANT 1 connector only, then select ANT 1. The internal tuner will be automatically bypassed when the transceiver is switched ON.

### VHF/ UHF/ 1.2 GHz Band

When you select the VHF, UHF, or 1.2 GHz (TS-2000/ TS-B2000 optional) band on the main transceiver and/or the sub-receiver, the following antenna is automatically selected based on the operating frequencies.

	MAIN transceiver (MHz)	SUB-receiver (MHz)
ANT 144	142 ~ 152 (K-type) 144 ~ 146 (All E-types)	118 ~ 174 (K-type) 220 ~ 300 (K-type) 144 ~ 146 (All E-types)
ANT 430	420 ~ 450 (K-type) 430 ~ 440 (All E-types)	300 ~ 512 (K-type) 430 ~ 440 (All E-types)
ANT 1.2G	1240 ~ 1300 (All types)	N/A

**Note:** The same antenna is shared and used when the main transceiver and sub-receiver are on the same band. The frequency coverage varies depending on the market codes.

## APO (Auto Power OFF)

You can set the TS-2000(X) to switch OFF automatically if no keys or controls are pressed or adjusted for a certain period of time. 1 minute before the transceiver switches OFF, “CHECK” is output in Morse code. You can select the time from OFF, 60, 120, and 180 minutes.

Press **[MENU]**, then turn the **MULTI/ CH** control to access Menu No. 57.

Select the APO time from OFF, 60, 120, or 180 minutes.

### Note:

- ◆ The APO function works even if the transceiver is scanning.
- ◆ The APO timer starts counting down the timer when no key presses, no control adjustments, and no command (RS-232C port) sequences are detected.

## AUTOMATIC ANTENNA TUNER

As explained in “ANTENNA CONNECTION” {page 1}, matching the impedance of the coaxial cable and antenna is important. To adjust the impedance between the antenna and the transceiver, you have the choice of using the internal tuner or an external tuner. This section describes how to use the internal tuner. For the external tuner, consult the instruction manual that comes with the tuner.

- 1 Select the transmit frequency.
- 2 Press **[FUNC]**, **[AT/ ANT1/2]** to select ANT 1 or ANT 2.
  - If an external tuner is connected to the ANT 1 connector, select ANT 2 to use the internal antenna tuner. The internal antenna tuner is automatically bypassed if an external antenna tuner is connected to ANT 1.
- 3 Press **[AT/ ANT1/2]** momentarily.
  - “AT TX” appears, indicating that the internal tuner is in-line (not bypassed).

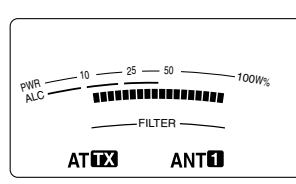

- 4 Press **[AT/ ANT1/2]** for more than one second.
  - CW mode is selected and tuning begins.
  - “TX” blinks and the **MAIN** band LED lights red.
  - To cancel tuning, press **[AT/ ANT1/2]** again.
  - If the SWR of the antenna system is extremely high (more than 10:1), an alarm (“SWR” in Morse code) sounds and the internal tuner is bypassed. Before attempting to tune again, adjust the antenna system to lower the SWR.
- 5 See the display and check that tuning has successfully finished.

- If the tuning was successful, “AT **TX**” stops blinking and the **MAIN** band red LED turns off.
- If tuning does not finish within approximately 20 seconds, an alarm (“5” in Morse code) sounds. Press **[AT/ ANT1/2]** to stop the alarm and tuning.

If you access Menu No. 27 and select ON, received signals will also pass through the internal tuner. When this function is ON, “**TXAT**” appears. This may reduce interference on the receive frequency.

**Note:**

- ◆ *The internal tuner will not tune outside the available transmission frequency limits.*
- ◆ *Pressing **[AT/ ANT1/2]** for more than one second while transmitting, interrupts transmitting and starts tuning.*
- ◆ *If you would like to use a separate receiving antenna, access Menu No. 18 and switch it ON. When this function is ON, received signals bypass the internal antenna tuner.*
- ◆ *While using CW Full Break-in, the internal tuner will be in-line for both transmitting and receiving.*
- ◆ *Tuning automatically turns OFF in approximately 60 seconds. “AT” disappears and the error beeps stop.*
- ◆ *Tuning may still continue when the SWR meter indicates 1:1. This happens due to the tuning algorithm; this is not a malfunction.*
- ◆ *Even though the SWR meter shows more than one segment, the internal tuner may not retune. This happens because of an SWR calculation algorithm tolerance between 10 W (approx.) transmit power for tuning and 100 W transmit power.*
- ◆ *If tuning does not finish even though the SWR meter indicates smaller than 3:1, adjust the antenna system to lower the SWR, then attempt to tune again.*
- ◆ *Tuning may not reach an SWR of 1:1, depending on the transceiver conditions.*

■ **Presetting**

After each successful tuning session, the AT Preset memory function stores the position of the tuning capacitor in the memory. The position of the capacitor is stored for each of the antenna tuner bands (see the following table) and for each antenna connector (ANT 1 and ANT 2).

Press **[AT/ ANT1/2]** momentarily.

- “AT **TX**” will appear, showing that the internal tuner is in-line (not bypassed).
- Each time you go across the antenna tuner band, the AT Preset memory is automatically recalled to position the tuning capacitor without the need for retuning. If no preset data exists for a particular band/antenna combination, then the default data of 50Ω is used.

**Note:** *Tuning may restart in order to obtain the optimum matching condition even though the current antenna tuner band has the preset data.*

AT Preset Frequency Range (MHz)	
0.03 ~ 1.85	1.85 ~ 2.50
2.50 ~ 3.525	3.525 ~ 3.575
3.575 ~ 3.725	3.725 ~ 4.10
4.10 ~ 7.03	7.03 ~ 7.10
7.10 ~ 7.50	7.50 ~ 10.50
10.50 ~ 14.10	14.10 ~ 14.50
14.50 ~ 18.50	18.50 ~ 21.15
21.15 ~ 21.50	21.50 ~ 25.50
25.50 ~ 29.00	29.00 ~ 30.00
30.00 ~ 51.00	51.00 ~ 52.00
52.00 ~ 53.00	53.00 ~ 60.00

**ATTENUATOR**

The attenuator function is useful when extremely strong signals exist nearby your receiving frequency. When these type of signals exist nearby your receiving frequency, the AGC function may be erroneously controlled by the strong signals, rather than by the target receiving signal. If this happens, the target receiving signal can be masked and buried by the strong signals. In this case, turn the Attenuator function ON.

1 Press **[ATT/ F LOCK]**.

2 “ATT” appears.

To return to the normal operation, press **[ATT/ F LOCK]** again.

**Note:** *If the same band is selected for both the main transceiver and the sub-receiver, the Attenuator function is on for both receivers.*

**AUTO MODE**

You can configure a maximum of 29 points (HF/ 50 MHz), 9 points (144 MHz band), 9 points (430 (440) MHz band), and 9 points (1.2 GHz band) of the main transceiver VFO (VFO A and B) frequencies to change the operating mode automatically when you change the frequency.

As a default, the following modes are programmed on each operating band.

HF/ 50 MHz band

0.03 ~ 9.5 MHz: LSB

9.5 MHz ~ 60 MHz: USB

144 MHz band

142 ~ 152 MHz: FM

430 (440) MHz band

420 ~ 450 MHz: FM

1.2 GHz band (optional)

1240 ~ 1300 MHz: FM

To add the frequency points to the Auto Mode selection:

## 15 OPERATOR CONVENIENCES

- 1 Press and hold **[USB/ LSB/ AUTO]+[ Ⓟ ]** (POWER) to turn the transceiver ON.
- 2 Press **[+]** or **[-]** to select the band to add the frequency points.
- 3 Select a memory channel number by turning the **MULTI/ CH** control.
- 4 Turn the **Tuning** control to select a desired frequency point to change the operating mode. Or, press **[ENT]** to enter the desired frequency point {page 37} using the numeric keys.
- 5 Press one of the mode keys to select the desired operating mode.
  - The selected mode appears on the main dot-matrix display.
- 6 Repeat steps 4 and 5 until you have added all the data.
- 7 Press **[CLR]** to store the data.

The table below shows the default Auto Mode frequency points for the HF/ 50 MHz band. When you activate the Auto Mode selection by pressing **[FUNC]**, **[LSB/ USB/ AUTO]**, the transceiver automatically selects the mode; LSB for frequencies below 9.5 MHz and USB for frequencies greater than or equal to 9.5 MHz.

Channel No.	Data	Operating mode
0	9.5 MHz LSB	0.03 MHz LSB < 9.5 MHz
1	9.5 MHz LSB	
2	9.5 MHz LSB	
3	9.5 MHz LSB	
• •	• •	
28	9.5 MHz LSB	

The table below is an example of how to add the frequency point of 1.62 MHz/ AM into memory. With this set up, the transceiver selects AM mode below 1.62 MHz, LSB mode from 1.62 MHz to 9.5 MHz and USB mode from 9.5 MHz to 60.0 MHz.

Channel No.	Data	Operating mode
0	1.62 MHz AM	0.03 MHz AM < 1.62 MHz
1	9.5 MHz LSB	
2	9.5 MHz LSB	1.62 MHz LSB < 9.5 MHz
3	9.5 MHz LSB	
• •	• •	9.5 MHz USB 60.0 MHz
28	9.5 MHz LSB	

The next table is an example of adding 4 frequency points into memory. With this setup, the transceiver selects AM mode below 1.62 MHz, CW mode from 1.62 MHz to 2.0 MHz, LSB mode from 2.0 MHz to 9.5 MHz, FM mode from 9.5 MHz to 53.0 MHz and USB mode from 53.0 MHz to 60.0 MHz. If multiple data contains the same frequency but a different mode is entered into memory, the lowest numbered memory channel is reflected as the Auto Mode.

Channel No.	Data	Operating mode
0	1.62 MHz AM	0.03 MHz AM < 1.62 MHz
1	2.0 MHz CW	
2	7.0 MHz LSB	2.0 MHz LSB < 9.5 MHz
3	9.5 MHz LSB	
• •	• •	9.5 MHz FM < 53.0 MHz
28	53.0 MHz FM	

To activate the AUTO MODE function, press **[FUNC]**, **[LSB/ USB/ AUTO]**.

## BEEP FUNCTION

The Beep function provides you confirmation of entry, error status, and malfunctions of the transceiver. Although you can turn the beep function OFF by accessing Menu No. 12, we recommend you leave it ON in order to detect unexpected errors and malfunctions.

You can also change the output level of the beeps by accessing Menu No. 12 and selecting 1 to 9.

The transceiver generates Morse code to tell you which mode is selected when you change operating modes.

When you change operating Modes, the following Morse code sounds:

Mode	Morse Code Output
LSB	• - •• (L)
USB	•• - (U)
CW	- • - • (C)
CW-R	- • - • - • (CR)
FSK	• - • (R)
FSK-R	• - • - • - • (RR)
AM/ AMN	• - (A)
FM/ FMN	•• - • (F)

The transceiver also generates the following warning, confirmation, and malfunction beeps.

Beeps	What it means
A high pitched short beep	A valid key is pressed.
A high pitched long beep	A Key entry is accepted, Scan starts, or AT tune has completed.
A low pitched short beep	An invalid operation is performed.
“UL” in Morse code	The internal PLL circuit unlock status is detected.
“S” in Morse code	CW Auto Tune cannot be completed, or an invalid frequency is entered.
“5” in Morse code	AT Tune cannot be completed within the specified time.
“SWR” in Morse code	The antenna’s SWR is too high (over 10:1) to perform AT Tune.
“CHECK” in Morse code	1 minute before the APO (Auto Power Off) function switches the transceiver OFF.
“BT” in Morse code	Waiting for a CW message to be recorded.
“AR” in Morse code	The current message memory is full.

## CALL CHANNEL

A CALL channel is a frequency that is often used when looking for a station with which to make contact in FM mode. Each frequency band (HF, 50 MHz, 144 MHz, 430/ 440 MHz, and 1.2 GHz) has one CALL channel. The default CALL frequencies are shown below.

To recall the CALL channel:

- 1 Press **[CALL/ C.IN]**.
- 2 Press **[CALL/ C.IN]** again to return to the previous operating frequency.

To revise the default CALL channel frequency:

- 1 Select a new CALL frequency and operating mode on the VFO.
- 2 Press **[FUNC]**, **[CALL/ C.IN]** to copy the new frequency and mode to the CALL channel.

Band	Default CALL Channel frequency and Mode
HF	29.60 MHz / FM
50 MHz	51.00 MHz/ FM
144 MHz	144.00 MHz/ FM
430/ 440 MHz	430.00 MHz <sup>1</sup> , 440.00 MHz <sup>2</sup> / FM
1.2 GHz	1240.00 MHz/ FM

<sup>1</sup> All E-types <sup>2</sup> K-type

## DISPLAY

### BRIGHTNESS

The brightness of the LCD display can be selected from OFF, and 1 to 4 by accessing Menu No. 00.

- 1 Press **[MENU]**, then turn the **MULTI/ CH** control to access Menu No. 00.
- 2 Press **[+]/ [-]** to select OFF, 1, 2, 3, or 4.
- 3 Press **[MENU]** to store the setting and exit Menu mode.

### CONTRAST

The contrast of the LCD dot-matrix display can be selected from 1 to 16 by accessing Menu No. 59.

- 1 Press **[MENU]**, then turn the **MULTI/ CH** control to access Menu No. 59.
- 2 Press **[+]/ [-]** to select an appropriate contrast from 1 to 16.
- 3 Press **[MENU]** to store the setting and exit Menu mode.

### KEY ILLUMINATION

The front panel key illumination can be switched ON or OFF.

- 1 Press **[MENU]**, then turn the **MULTI/ CH** control to access Menu No. 01.
- 2 Press **[+]/ [-]** to select ON or OFF.
- 3 Press **[MENU]** to store the setting and exit Menu mode.

## DTMF

### MANUAL DTMF DIALING

If you have a MC-52DM microphone, you can send DTMF tones while you are transmitting.

To send a series of DTMF tones:

- 1 Press Mic **[PTT]** or **[SEND]** on the front panel.
- 2 Press the desired DTMF keys to transmit.
  - DTMF tones are monitored through the speaker.
- 3 Release Mic **[PTT]** or press **[SEND]** on the front panel to return to receive mode.

### DTMF MEMORY

#### ■ Entering DTMF tones

The transceiver has 10 DTMF Memory Channels. Each channel can store a series of 16 DTMF tones. You can also name each DTMF entry using a maximum of 8 alpha-numeric characters.

- 1 Press **[MENU]**, then turn the **MULTI/ CH** control to access Menu No. 45.
- 2 Press **[SUB]** to access Menu No. 45A.
- 3 Press **[SUB]** again to enter DTMF Memory Channel mode.

## 15 OPERATOR CONVENIENCES



- 4 Select a DTMF Memory Channel (0 to 9) using the **MULTI/ CH** control.
- 5 Press **[SUB]** to enter the desired memory name. Use **[+]/ [-]** to select the characters. Press **[MAIN]** or **[SUB]** to move the cursor left or right while entering the DTMF memory name. You can also use the Mic DTMF keys to enter the characters. Refer to the table on page 63 for the available characters and numbers.



- 6 Press **[M.IN]** to store the name into memory.
- 7 Select the desired DTMF tone using **[+]/ [-]**, then press **[SUB]** to move the cursor to the right to enter the next DTMF tone.
- 8 Repeat step 7 until you enter all the desired DTMF tones. You can enter a maximum of 16 DTMF tones for each DTMF Memory Channel.



- 9 Press **[M.IN]** to store the data into memory.

### ■ Transmitting DTMF Memory Channel Data

To send the DTMF Memory Channel data while you are transmitting:

- 1 Press **QUICK MEMO [MR]** while you are transmitting.
- 2 The DTMF Memory Channel number and the memory name appear on the main dot-matrix display.
- 3 Turn the **MULTI/ CH** control to select the DTMF Memory Channel you want to transmit.
- 4 Press **QUICK MEMO [MR]** to transmit the DTMF tones.
  - The DTMF tones are monitored through the speaker while they are transmitted.

### ■ DTMF Tone Time Length

When transmitting a series of DTMF tones, each tone duration is set to the 50 ms (tone)/ 50 ms (mute) format as default. Some repeaters or auto patch controllers may require longer DTMF tones and mutes.

- 1 Press **[MENU]**, then turn the **MULTI/ CH** control to access Menu No. 45B.
- 2 Press **[-]** to select SLOW.
- 3 Press **[MENU]** to exit the Menu mode.

The DTMF tones will now be sent using the 100 ms (tone)/ 100 ms (mute) format.

### DTMF Pause Period

In the DTMF Memory, you can enter blanks (pauses) among a series of DTMF tones. The default pause period is set to 500 ms, but you can change this value by accessing Menu No. 45C.

- 1 Press **[MENU]**, then turn the **MULTI/ CH** control to access Menu No. 45C.
- 2 Press **[+]/ [-]** to select the desired DTMF Pause period (default is 500 ms).
- 3 Press **[MENU]** to exit the Menu mode.

### HF RX ANTENNA

If you have a separate HF antenna (below 30 MHz) only for receiving, connect the antenna coaxial cable to the HF RX ANT connector on the rear panel. This connector is considered to be connected to a beverage antenna or directional loop antenna for low-band operation.

To use the HF RX ANTENNA connector, access Menu No. 18 and select ON. When the HF RX ANTENNA is selected for receiving, "**EXT**" appears on the display.

### LINEAR AMPLIFIER CONTROL

When you connect an external HF linear amplifier to the TS-2000(X) transceiver using the **REMOTE** connector, select 1 (fast switching/ 10 ms delay) or 2 (slow switching/ 25 ms delay) to activate the internal relay so you can interface with the HF linear amplifier {page 94}.

Some linear amplifiers require a long transmission delay time because of the slow antenna relay switching time. In this case, select 2 for the slow switching.

If you have 50 MHz, 144 MHz, 430/ 440 MHz, or 1.2 GHz band linear amplifiers, connect the linear amplifier control cable to the **EXT.CONT** connector for these bands {page 96}.

- 1 Press **[MENU]**, then turn the **MULTI/ CH** control to select Menu No. 28A (HF), 28B (50 MHz), 28C (144 MHz), 28D (430 (440) MHz), or 28E (1.2 GHz).
- 2 Press **[+]/ [-]** to select OFF, 1, or 2.
  - OFF disables the TS-2000(X) relay.
  - 1 is 10 ms transmission delay.
  - 2 is 25 ms transmission delay.

**Note:** If CW full break-in is enabled, 10 ms transmission delay is applied regardless of the Menu No. 28 settings.

## LOCK FUNCTIONS

### FREQUENCY LOCK FUNCTION

Frequency Lock disables some keys and controls to prevent you from accidentally activating a function or changing the current settings.

Press **[FUNC]**, **[ATT/ F LOCK]** to toggle Frequency Lock ON or OFF.

- “**LOCK**” appears when this function is ON.

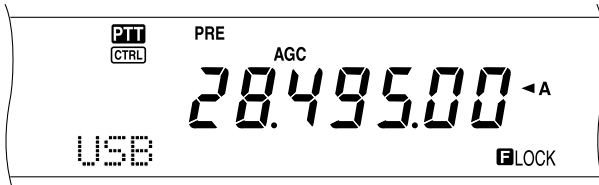

The following keys and controls are disabled by Frequency Lock:

Tuning control	MULTI/ CH control	A/B
A=B	CALL	CLR
CW/ FSK	DISP	ENT
FM/ AM	LSB/ USB/AUTO	M.IN
M ▶ VFO	QUICK MEMO [M.IN]	QUICK MEMO [MR]
SATL	SCAN/ SG.SEL	SPLIT
UP/ DOWN	VFO/ M	1MHz/ SEL
1/ CH1/REC	2/ CH2/REC	3/ CH3/REC
9/ FINE/STEP	+/ -	

**Note:**

- ◆ After activating Frequency Lock, the **MULTI/ CH** control and **[+]/ [-]** are still available in Menu mode.
- ◆ After activating Frequency Lock, you can still change the transmit frequency with the **Tuning** control while in **TF-SET** mode.
- ◆ After activating Frequency Lock, the **MULTI/ CH** control is still available for selections other than frequency and memory channel changes.
- ◆ After activating Frequency Lock, **[CLR]** may be available in some situations.

### LOCK ALL FUNCTION

The Lock All function disables all the keys and controls on the TS-2000 transceiver, except **[FUNC]**, **[PRE/ LOCK A]**, Mic **[PTT]** and **[FUNC]**, **[ATT/ F LOCK]**.

Press **[FUNC]**, **[PRE/ LOCK A]** to toggle between the Lock All function ON or OFF.

- “**LOCK**” appears when this function is ON.

To return to normal operation, press **[FUNC]**, **[PRE/ LOCK A]**.

### MICROPHONE PF KEYS

When using the optional MC-47 (or MC-52DM) microphone, you can customize the functions of the Microphone PF1 (CALL), PF2 (VFO), PF3 (MR), and PF4 (PF) keys. You can assign the following types of functions to these keys via Menu Nos. 51B ~ 51E:

- Directly select a Menu No. without pressing **[MENU]** and turning the **MULTI/ CH** control.
- Activate the same function as one of the front panel keys.

One of the following functions can be assigned to each PF key. Selecting OFF assigns no function to the PF key.

A.N.	ANT1/2	A=B	A/B	B.C.	CALL	CH1
CH2	CH3	CLR	CTRL	CW TUNE	DSP MONI	
FINE	M.IN	M.IN(QUICK MEMO)		MR (QUICK MEMO)		
M ▶ VFO	MENU Number	NB	N.R.	OFF	1MHz	
RX MONI	SCAN	SPLIT	TF-SET	VFO/M	VOICE1	
VOICE2						

### MONITOR

When you are receiving while the squelch function is ON, weak signals become intermittent.

Or, if the CTCSS function is ON, you may want to disable the squelch function temporarily to monitor the current channel activities.

In these cases, use the MONITOR function to disable the squelch function temporarily.

To assign the MONITOR function to a **[PF]** key on the front panel:

- 1 Press **[MENU]** and turn the **MULTI/ CH** control to access Menu No. 51A.
- 2 Press **[+]/ [-]** to select RX MONI.
- 3 Press **[MENU]** to exit Menu mode.

**Note:** You can also assign the MONITOR function to a programmable function key on an optional MC-47 microphone.

### PF KEY

You can program the front panel **[PF]** key to assign a function that you frequently use. The default is Voice 1 for the optional Voice Synthesizer, VS-3 {page 91}. You can assign one of the functions in “MICROPHONE PF KEYS” to this PF key, accessing Menu No. 51A.

### RISE TIME OF CW

The rise time of a CW signal is the time for the RF output to rise to its maximum power after the key is closed. The default setting, 6 ms, is fine for slow to medium keying speed and normal weighting (dot/dash ratio). The 4, 2 or 1 ms settings are good for faster keying speeds.

- 1 Press **[MENU]**, then turn the **MULTI/ CH** control to access Menu No. 32.
- 2 Press **[+]/ [-]** to select the desired rise time (default is 6 ms).
- 3 Press **[MENU]** to store the setting and exit Menu mode.

## 15 OPERATOR CONVENIENCES

### RX DSP EQUALIZER

#### EQUALIZING RECEIVING AUDIO (SSB/ FM/ AM)

Use Menu No. 20 to change the receiver frequency responses of the target signal. You can select one from six different receiver profiles including the default flat response. Selecting any of the following items from the Menu causes “EQ ” to appear on the display.

- **Off (OFF):**  
The default frequency response for SSB, FM, and AM.
- **High boost (H BOOST):**  
Emphasizes higher audio frequencies; effective for a bassy voice.
- **Formant pass (F PASS):**  
Improves clarity by suppressing audio frequencies outside the normal voice frequency range.
- **Bass boost (B BOOST):**  
Emphasizes lower audio frequencies; effective for a voice with more high frequency components.
- **Conventional (CONVEN):**  
Emphasizes by 3 dB frequencies at 600 Hz and higher.
- **User (USER):**  
Reserved for the ARCP software. Off is programmed at the factory as a default.

### SEPERATE SPEAKER OUTPUT

The TS-2000(X) has 2 independent receivers and is capable of receiving 2 different frequencies at the same time. If no external speaker is connected to the TS-2000(X), both audio signals are mixed internally, then output through the internal speaker.

- 1 Connect the external speaker(s) to the **EXT.SP1** and/or **EXT.SP2** jack on the rear panel {page 2}.
- 2 Press **[MENU]**, then turn the **MULTI/ CH** control to access Menu No. 16.
- 3 Press **[+]/ [-]** to select 0, 1 or 2.
- 4 Press **[MENU]** to store the setting.

Menu Selection	L-channel	R-channel
0	Main & Sub Mixed	Main & Sub Mixed
1	Main	Sub
2	Main + 1/4 Sub	Sub + 1/4 Main

If you are using an external speaker on EXT.SP2, you can configure the transceiver to make a separate output for each receiver.

EXT.SP1	EXT.SP2		OUTPUT		
			Internal SP (L)	SP1 (L)	SP2 (R)
–	–	➔	√	N/A	N/A
√	–	➔	Mutes	√	N/A
–	√	➔	√	N/A	√
√	√	➔	Mutes	√	√

If you want to reverse the output:

- 1 Press **[MENU]**, then turn the **MULTI/ CH** control to access Menu No. 17.
- 2 Press **[+]** to select ON.
- 3 Press **[MENU]** to store the setting and exit Menu mode.

The output is now reversed.

**Note:** If you are using headphones, the transceiver mutes. The left channel represents the internal SP or EXT.SP1 and the right channel represents the EXT.SP2.

### S-METER SQUELCH

The S-meter Squelch function opens the squelch only when the receiving signal has the same or greater strength than the S-meter Squelch setting. This function helps you to not open the squelch when receiving weak signals that you do not want to hear.

- 1 Press **[MENU]**, then turn the **MULTI/ CH** control to access Menu No. 19A.
- 2 Press **[+]** to select ON.
- 3 Turn the **MAIN SQL** control and/or the **SUB SQL** control to adjust the S-meter Squelch threshold level. When you turn **SQL** control, the indicators on the S-meter move accordingly.
- 4 Press **[MENU]** to store the settings and exit Menu mode.

**Note:** The squelch threshold level of the S-meter squelch is around the 9 o'clock position for FM (both MAIN and SUB SQL), the 11 o'clock position for other modes (MAIN SQL), and the 9 o'clock position for AM (SUB SQL), regardless of the SQL controls position.

### SQUELCH HANG TIME

You can adjust the squelch hang time to continuously monitor unstable signals. When the signal is temporarily weaker than the S-meter Squelch threshold level, the squelch does not mute the signal for a short period of time. In this way, you can continuously monitor the unstable signal.

- 1 Press **[MENU]**, then turn the **MULTI/ CH** control to access Menu No. 19B.
- 2 Press **[+]/ [-]** to select OFF, 125 ms, 250 ms, or 500 ms.
- 3 Press **[MENU]** to store the settings and exit Menu mode.

### TIME-OUT TIMER

The Time-out Timer limits the time of each transmission. It is also useful to prevent a long accidental transmission.

- 1 Press **[MENU]**, then turn the **MULTI/ CH** control to access Menu No. 24.
- 2 Press **[+]/ [-]** to select OFF, 3 minutes, 5 minutes, 10 minutes, 20 minutes, or 30 minutes.
- 3 Press **[MENU]** to store the settings and exit Menu mode.



## TNC

This transceiver has a built-in TNC that is usually used for the Packet Cluster Tune {page 53} or SkyCommand II+ operations {page 83}. However, you can also utilize the built-in TNC as a high (9600 bps) or normal (1200 bps) speed TNC. The TNC can be controlled by an external PC that is connected to COM port on the rear panel {page 49}. Available TNC command set is listed in the Appendix.

If you desire, you can connect an external TNC or proprietary TNC/ MCP to ACC2 connector. To interface an external TNC/ MCP with the TS-2000(X), refer to the ACC2 connector information {page 95} and accessing Menu Nos. 50B ~ 50F then configure and adjust the Menu parameters to work with the external TNC/ MCP.

**Note:** You do not have to disable the built-in TNC to interface with an external TNC. Both the main transceiver and sub-receiver can work independently unless the transceiver is transmitting on the same band.

## TRANSVERTER

If you have a transverter that converts the TS-2000 operating frequencies to other frequencies, you can use this TS-2000 transceiver as a transverter exciter. Consult the instruction manual that came with the transverter for interfacing to the TS-2000.

- 1 Connect the transverter to the **ANT 1**, **ANT 2**, **ANT 144**, **ANT 430**, or **ANT 1.2G** (TS-2000 optional) connector on the rear of the transceiver.
- 2 Select the exciter operating frequency on the main transceiver of the TS-2000(X).
  - The transverter will use this frequency as the reference for converting frequencies.
- 3 Access Menu No. 25, and select ON by pressing **[+]**.
  - The output power is automatically set to the lowest power for that frequency. See TX POWER (below).
- 4 Press **[MENU]** to store the setting and exit the Menu mode.
- 5 Press **[ENT]**, then set the target converting frequency, using the numeric keys.
- 6 Press **[ENT]** to complete the entry.
- 7 The transceiver displays the target transverter frequency instead of the actual operating frequency.

**Note:** When using a transverter, not all the functions of this transceiver are available.

## TX MONITOR

TX monitor allows you to monitor the on-going transmission sound. This is convenient when you want to check the modulation sound quality of the transmission. In FSK mode, you can monitor the FSK signal that the TS-2000(X) is transmitting.

- 1 Press **[FUNC]**, **[PWR/ TX MONI]**.
- 2 The current TX monitor setting appears.
- 3 Turn the **MULTI/ CH** control to select the monitor sound level from OFF, and 1 to 9.
- 4 Press **[CLR]** to store the selected TX monitor level.

**Note:**

- ◆ We recommend you use headphones when you monitor SSB, AM, or FM mode, in order to avoid howling.
- ◆ The CW transmission signal cannot be monitored using the TX monitor function. Use the CW sidetone function to monitor CW transmissions (Menu Nos. 13 and 31).

## TX POWER

You can adjust the transmission output power by pressing **[PWR/ TX MONI]** and turning **MULTI/ CH** control. If more precise power adjustment is required, access Menu No. 23 and select ON. When this menu is ON, the power adjustment steps change as shown in the table below.

Band	Mode	Menu No. 23 OFF	Menu No. 23 ON
HF/ 50 MHz/ 144 MHz	SSB/ CW/ FM/ FSK	5 ~ 100 W in steps of 5	5 ~ 100 W in steps of 1
	AM	5 ~ 25 W in steps of 5	5 ~ 25 W in steps of 1
430/ 440 MHz	SSB/ CW/ FM/ FSK	5 ~ 50 W in steps of 5	5 ~ 50 W in steps of 1
	AM	5 ~ 12.5 W in steps of 1	
1.2 GHz	SSB/ CW/ FM/ FSK	1 ~ 10 W in steps of 1	
	AM	1 ~ 2.5 W in steps of 1	

**Note:**

- ◆ The output power settings are stored independently for HF, 50 MHz, 144 MHz, 430/ 440 MHz and 1.2 GHz (TS-2000/ TS-B2000 optional). As shown in the table above, you can also store different output power settings for AM and other modes for each operating band.
- ◆ For AM mode in the 430/ 440 MHz band and the 1.2 GHz (TS-2000/ TS-B2000 optional) band, the final step is 0.5 W, rather than 1 W.

---

## 15 OPERATOR CONVENIENCES

---

### QUICK DATA TRANSFER

This transceiver has the capability to quickly and conveniently transfer the receive frequency and mode to another compatible transceiver. Compatible transceivers include:

- TS-2000(X)
- TS-570S/ 570D
- TS-870S
- TS-590S/ 590SG
- TS-990S

Data Transfer could be useful while contesting. A spotting station that is searching for new contest multipliers can quickly transfer a frequency over to the running (main) station.

### SETTING UP

#### ■ Equipment Needed

In addition to a compatible transceiver, the following equipment is required:

#### Transfer to TS-2000(X), TS-990S, TS-590, TS-570, or TS-870S:

- One cross-wired cable. This cable must have a 9-pin RS-232C female connector at both ends.

#### ■ Connections

For diagrams on how to connect the two transceivers, see "CONNECTING PERIPHERAL EQUIPMENT" {page 93}.

**Note:** If you are using a DSP-100 unit with the transceiver, turn on the transceiver first, then turn on the DSP-100.

### USING QUICK TRANSFER

When connecting with another TS-2000(X), TS-990S, TS-590, TS-570, or TS-870S, use the same **COM** connector baud rate on each transceiver. If transferring to or from other **KENWOOD** transceivers, select 4800 bps and 2 stop bits. On the TS-2000(X), set the parameter in Menu No. 56 to 4800 bps.

**Note:** While transferring data, other functions may work slower.

#### ■ Transferring Data

The TS-2000(X) transceiver works as the Master, sending data to the Slave transceiver.

- 1 Switch ON the Transfer function of each transceiver.
  - On the TS-2000(X), access Menu No. 52 and select ON. For the compatible transceiver, refer to the instruction manual that came with the transceiver.
- 2 On the Master, while in VFO mode, select an operating frequency and mode.

- 3 On the Master, press **QUICK MEMO [M.IN]**.
  - When using another TS-2000(X) as the Slave, "PC" appears on the Slave.
  - The displayed data is stored in Quick memory channel 0 on the Master and transferred to the Slave.

**Note:** If the Master has RIT switched ON, the offset frequency is added to the receive frequency to be transferred.

#### ■ Receiving Data

The TS-2000(X) transceiver works as the Slave, receiving data from the Master transceiver. The Slave can receive data using either Quick memory channel 0 or the VFO.

- 1 Switch ON the Transfer function of each transceiver.
  - On the TS-2000(X), access Menu No. 52 and select ON. For the compatible transceiver, refer to the instruction manual that came with the transceiver.
- 2 On the Slave, access Menu No. 53 and select either OFF (QUICK MEMO channel 0) or ON (the VFO).
  - The default is OFF (QUICK MEMO).
- 3 On the Master, perform the appropriate operation to send data.
  - For the correct method, refer to the instruction manual that came with the transceiver.

#### **Note:**

- ◆ If you always use the TS-2000(X) for receiving only, activate the TX Inhibit function, accessing Menu No. 54 to avoid unintentional transmission.
- ◆ When the Slave receives data using the VFO programmed with a simplex frequency, the received data replaces the data on both VFOs. On the Slave, both RIT and XIT are set to OFF.
- ◆ When the Slave receives data using the VFOs programmed with split frequencies, the received data replaces the data only on the TX side of the VFO. On the Slave, XIT is set to OFF but RIT is not changed.

## COMPUTER CONTROL

By connecting this transceiver to a computer, you can change the computer into an electronic console from which you can remotely control functions of the transceiver. This capability makes remote operation of your transceiver possible from across the room, from another room, or when coupled with other commercially available products and where lawful, from another city, state, or country via a telephone connection.

**Note:**

- ◆ You can use the front panel controls while using computer control. Settings done from the front panel are effective immediately.
- ◆ After the computer is disconnected or turned off, all values and settings on the front panel are restored.

## SETTING UP

### ■ Equipment Needed

- A PC equipped with an RS-232C serial port.
- One straight cable. This cable must have a 9-pin D-Sub RS-232C female connector at one end, and at the other end a 9-pin or a 25-pin D-Sub RS-232C female connector that mates with the RS-232C port of your computer.
- Transceiver control application.

To design your programs, consult "APPENDIX" for the necessary information.

### ■ Connections

Connecting the transceiver to the computer is easy. See the diagram given in "CONNECTING PERIPHERAL EQUIPMENT" {page 93}.

**Note:** Before connecting this transceiver to the computer, switch OFF the power to both the transceiver and the computer.

## COMMUNICATION PARAMETERS

In order to control the transceiver by computer, you must first choose the communication parameters.

- 1 On the computer, configure your transceiver control application for 8 data bits, 1 stop bit and no parity.
- 2 On the transceiver, select the same transfer rate and number of stop bits via Menu No. 56.
  - The defaults are 9600 bps and 1 stop bit.

**Note:** To reliably use the 38400 or 57600 bps transfer rates, the RS-232C port of the computer must support these high-speed communications parameters.

## REMOTE MICROPHONE CONTROLLER

If you have a DTMF microphone, you can use the microphone as a wired remote control unit as described below.

- 1 Plug the DTMF microphone into the microphone connector of the transceiver.
- 2 Press **[MENU]**, then turn the **MULTI/ CH** control to access Menu No. 45D.
- 3 Press **[+]** to select ON.
- 4 Press **[MENU]** to store the setting and exit Menu mode.

The DTMF keys function as follows:

DTMF key	Function	FUNC mode	DTMF key	Function	FUNC mode
1	Scan	–	9	Squelch <sup>1</sup> Up/ Down	–
2	Tone/ CTCSS/ DCS	Code Select	0	PWR <sup>1</sup> Up/ Down	–
3	REV	SHIFT	A	ENT	–
4	MHz	–	B	CTRL	MAIN/ SUB
5	MONI	LOCK ON <sup>2</sup>	C	Repeater	–
6	Voice 1	LOCK OFF <sup>2</sup>	D	FUNC	FUNC OFF
7	Volume <sup>1</sup>	–	*	Down	Down
8	Band <sup>1</sup>	–	#	Up	Up

<sup>1</sup> Use the **[#]** (Up) and **[\*]** (Down) keys to change the settings of these functions.

<sup>2</sup> The LOCK function is for the microphone keypad.

**Note:**

- ◆ Microphone Remote does not function while transmitting.
- ◆ You can use the DTMF Memory function (page 75) with the Microphone Remote function.
- ◆ The Repeater function is available for K-type models only.
- ◆ Normally, pressing **[2]** cycles through Tone, CTCSS, DCS, and OFF. However, if 1750 Hz is selected for Tone, pressing **[2]** will only transmit the 1750 Hz tone. To return to Tone/ CTCSS/ DCS mode, you must first deselect 1750 Hz for Tone.
- ◆ Press **[D]** to enter FUNC mode, to use the 2nd function of the DTMF keys. Pressing **[D]** while in FUNC mode will exit FUNC mode.
- ◆ **[FUNC]** on the transceiver works independently from the Microphone Remote **[FUNC]** key.

## 15 OPERATOR CONVENIENCES

### WIRELESS REMOTE CONTROL (K-type ONLY)

If you have a Kenwood TH-D7A/ TH-D72A handheld Atransceiver, you can use it to remotely control the 144 MHz and 440 MHz bands of the TS-2000(X) transceiver, using FM mode. You will be controlling one band on the TS-2000(X) transceiver while sending DTMF tones to the other band from the remote control transceiver. This function is useful, for example, when you want to control the VHF/ UHF FM repeater function of the TS-2000(X) transceiver from a location outside your home or vehicle.

**Note:**

- ◆ To remotely control the TS-2000(X), you can also use a handheld transceiver which does not have a remote control function, but a DTMF function. You must, however, manually send DTMF tones for control code strings. Skip steps 1 and 3 in "PREPARATION", below.
- ◆ FCC rules permit you to send control codes only on the 440 MHz band.

### PREPARATION

Assuming that the 144 MHz band of the TS-2000 transceiver will be controlled.

**On the control transceiver:**

- 1 Program a 3-digit secret number.
  - If you are using a TH-D7A or TH-D72A, see "WIRELESS REMOTE CONTROL" in its instruction manual.
- 2 Select the transmit frequency on the 440 MHz band.
- 3 Enter the Remote Control mode.

**On the TS-2000 transceiver:**

- 4 Access Menu 61C, and select the same secret number that you selected in step 1.
- 5 Select the receive frequency on the 440 MHz band of the sub-receiver.
  - Mate this frequency with the transmit frequency on the control transceiver.
- 6 Select the 144 MHz band as the TX band or Control band for the main transceiver.
- 7 To have the TS-2000(X) transceiver send a control acknowledgment to the handheld, access Menu 61D and select "ON".
  - DTMF tones which represent the secret number will be used as an acknowledgment.
- 8 Access Menu 61E and select "ON".
  - "LOCK  " appears when the TS-2000(X) enters Remote Control mode.

### CONTROL OPERATION

When in Remote Control mode, the DTMF keys of the control transceiver will function as shown in the table below. Each time you press the desired key, the transceiver will automatically enter transmit mode and send the corresponding command to the mobile.

**Note:** If you are using a transceiver without a remote control function, manually send "AXXX#YA#" where "XXX" is your 3-digit secret number and "Y" is a single-digit control command. If you do not add "A#" on the end, you can skip sending "AXXX#" next time; however, the mobile may be accidentally controlled by other stations.

1	DCS ON	9	MR
2	TONE ON	0	LOW
3	CTCSS ON	A	ENTER
4	DCS OFF	B	TONE SEL
5	TONE OFF	C	REPEATER ON
6	CTCSS OFF	D	REPEATER OFF
7	CALL	✕	DOWN
8	VFO	#	UP

To change the transmit/ receive frequency:

([VFO] → [ENTER] → [0] ~ [9] (enter the necessary digits) → [ENTER]) or ([VFO] → [UP]/ [DOWN])

To recall a memory channel:

([MR] → [ENTER] → [0] ~ [9] (enter the necessary digits) → [ENTER]) or ([MR] → [UP]/ [DOWN])

To change the tone (or CTCSS) frequency:

([TONE SEL] → [0] ~ [9] (enter 2 digits; ex. [0], [5]) → [TONE SEL])

- Use Nos. 01 to 38 shown in the table on page 35.
- First activate the Tone or CTCSS function. You can select a separate tone frequency for the Tone and CTCSS functions.

**Note:** While in Wireless Remote Control mode, you can perform only the following operations on the TS-2000(X) transceiver.

- Transmit
- Acknowledge ON/ OFF
- Secret Number Change
- Partial/ Full Reset

## SKY COMMAND II + (K-type ONLY)

The Sky Command II+ allows you to remotely control the TS-2000(X) transceiver from a separate location. Since the TS-2000(X) transceiver has an independent VHF and UHF sub-receiver in addition to the main transceiver, the sub-receiver can work as a “Transporter” without requiring another VHF/ UHF transceiver.

So, if you already have **Kenwood’s** TH-D7A/ TH-D72A/E handheld or TM-D700A/ TM-D710A mobile transceiver, you can immediately start enjoying Sky Command II+ features to remotely control the HF/ 50 MHz band of your TS-2000(X).

Or, if you have a friend who has another TS-2000(X), you can also use his/her TS-2000(X) as a “Commander” (a remote unit) to control the HF/ 50 MHz band of your TS-2000(X) at home, using VHF and UHF bands.

You will use one transceiver as a remote control unit, called a “Commander”. The VHF/ UHF sub-receiver in the TS-2000(X) transceiver is called the “Transporter”. It will function as an interface between the Commander and the HF/ 50 MHz band of the TS-2000(X) main transceiver.

This system allows you, for example, to watch for and hunt DX while washing your car, or to operate the HF transceiver while relaxing in your car, living room, or patio, instead of actually operating inside your shack.

**Note:** Refer to the respective instruction manuals of the TH-D72A/E, TM-D710A/E, TM-D710GA/E, or TM-V71A/E+RC-D710 for information on how to connect, configure, and operate the transceivers for Sky Command II.

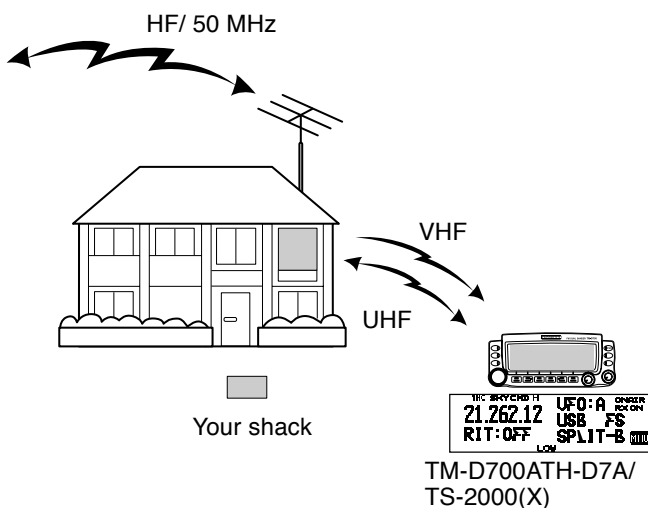

## SKY COMMAND II + DIAGRAM

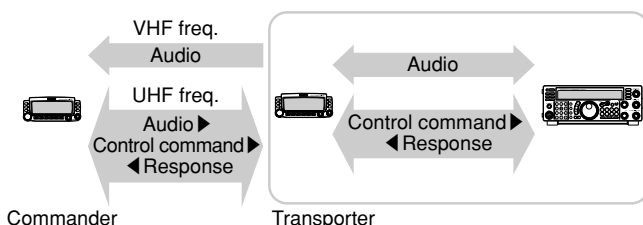

## PREPARATION

Although you can use either a TM-D700A, a TH-D7A, or another TS-2000(X) transceiver as a “Commander” (an external remote control unit), the following procedure shows how to set up your TS-2000 as a “Transporter” at a base station and the TM-D700A as a “Commander”.

### TS-2000 (Transporter) Setup:

- 1 Press **[MENU]**, then turn the **MULTI/ CH** control to access Menu No. 62A.
- 2 Press **[SUB]** then enter your callsign (ex: WD6DJY) as a “Commander” callsign, using **[+]/ [-]** or the **MULTI/ CH** control. To move the cursor, press **[MAIN]** or **[SUB]**. Press **[M.IN]** to store the callsign to Menu No. 62A.
- 3 Press **[MENU]**, then turn the **MULTI/ CH** control to access Menu No. 62B.
- 4 Press **[SUB]** then enter your alias callsign (ex: WD6DJY-1) as a “Transporter” callsign, using **[+]/ [-]** or the **MULTI/ CH** control. To move the cursor, press **[MAIN]** or **[SUB]**. Press **[M.IN]** to store the callsign to Menu No. 62B.

*Note:* You can use alpha-numeric characters, A to Z, 0 to 9 and “-”. The callsign must be no more than 9 characters long, including “-”. Also, the following callsign formats cannot be entered:

- WD6DJYZ  
If you use only letters and numbers for the callsign, the maximum length is 6 characters.
- WD6-DJY-1  
You cannot use more than 1 “-” within a callsign.
- -WD6DJY  
You cannot use a “-” as the first callsign character.
- WD6DJY-19  
An SSID must be within the range of 1 to 15.

- 5 Access Menu No. 62C, then turn the **MULTI/ CH** control to select a CTCSS tone frequency for Sky Command II+ (default is 88.5 Hz).
- 6 Access Menu No. 62D and select the communication speed for Sky Command II+. Select 1200 bps for TM-D700A (9600 bps can be used only when you use another TS-2000(X) as a “Commander”).
- 7 Access Menu No. 46 and select SUB.
- 8 Select a 144 MHz band frequency in FM mode on the main transceiver and 440 MHz band frequency in FM mode for the sub-receiver for Sky Command II+ operation.

### TM-D700A (Commander) Setup:

- 1 Access Menu 4-1 and 4-2 to enter the same callsign that you entered for TS-2000(X).
- 2 Access Menu 4-3 to select the same CTCSS tone frequency that you selected for TS-2000(X) (Transporter).

**Note:** Refer to Chapter 17, Sky Command II, of the TM-D700A instruction manual for details on how to enter the callsign and CTCSS tone frequency.

## 15 OPERATOR CONVENIENCES

### Starting Sky Command II+ operation:

After you have completed the following setups, you can start Sky Command II+ operation. Without programming these parameters, you cannot perform Sky Command II+ operation.

#### On the TS-2000 (Transporter):

- 1 Select the desired HF frequency that you want to be controlled on the main transceiver.
- 2 Select an open VHF frequency in FM mode for the main transceiver and another open UHF frequency in FM mode for the sub-receiver.
- 3 Press **[MENU]**, then turn the **MULTI/ CH** control to access Menu No. 62E.
- 4 Select T-PORTER (Transporter).
- 5 Press **[MENU]** to enter the Transporter mode.

#### On the TM-D700A (Commander):

- 1 Select the same VHF and UHF frequencies that you selected for the TS-2000 (Transporter).
- 2 Access Menu 4-4 to select COMMANDER.
  - "PRESS [0] KEY TO START COMMANDER!!" appears.
- 3 Press **[0]** on the DTMF Mic of the TM-D700A to start the Sky Command II+ operation.

## CONTROL OPERATION

After setting up both the TS-2000 (Transporter) and the TM-D700A (Commander) for Sky Command II+ operation, press Mic **[0]** on the Commander. While in Sky Command mode, the Mic keys of the Commander will function as described below.

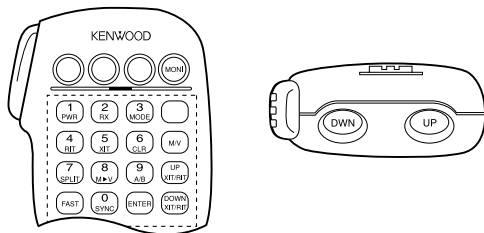

Each time you press a key, the Commander will automatically enter transmit mode and send the corresponding control command to the Transporter.

To switch the HF transceiver OFF	Press Mic <b>[1]</b> .
To change the frequency or memory channel on the HF transceiver	Press Mic <b>[UP]/ [DWN]</b> .
To transmit audio on an HF frequency	Press and hold Mic <b>[PTT]</b> , then speak into the microphone.
To receive audio on an HF frequency	Press Mic <b>[2]</b> .
To monitor the UHF band on the Commander	Press the Mic <b>PF</b> key assigned to the Monitor function.

Mic Key	Function
<b>1</b>	Power OFF
<b>2</b>	HF frequency receive ON/ OFF
<b>3</b>	Modulation mode switch
<b>4</b>	RIT ON/ OFF
<b>5</b>	XIT ON/ OFF
<b>6</b>	RIT offset or XIT offset clear
<b>7</b>	Split-frequency ON/ OFF
<b>8</b>	Transfer from Memory to VFO
<b>9</b>	In VFO mode: VFO A/ VFO B switch In Memory Recall mode: no change
<b>0</b>	Current settings retrieve (from HF transceiver)
<b>B</b>	VFO/ Memory Recall mode switch
<b>C</b>	XIT/ RIT offset frequency increase
<b>D</b>	XIT/ RIT offset frequency decrease
<b>*<sup>1</sup></b>	In LSB, USB, or CW mode: 10 Hz/ 1 kHz switch In FM or AM mode: 1 kHz/ 10 kHz switch
<b>#<sup>2</sup></b>	In VFO mode: frequency entry ON In Memory Recall mode: channel number entry ON

<sup>1</sup> "FS" appears when you select 1 kHz step (LSB/ USB/ CW) or 10 kHz step (FM/ AM).

<sup>2</sup> After pressing Mic **[#]**, press Mic **[0]** to **[9]** to enter a frequency or memory channel number.

When Mic **[0]** is pressed, the Commander shows the current settings of the HF transceiver:

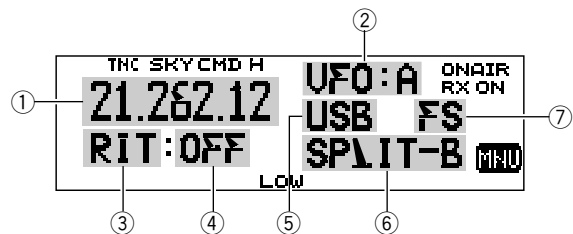

- ① HF frequency
- ② VFO: A, VFO: B, MR: 00 ~ 99 (memory channel number)
- ③ RIT, XIT
- ④ OFF, -9.99 ~ +9.99
- ⑤ LSB, USB, CW, FM, or AM
- ⑥ SPLIT-A: VFO A is used for transmitting. SPLIT-B: VFO B is used for transmitting. SPLIT-M: A memory channel is used for transmitting.
- ⑦ "FS" appears when Mic **[\*]** is pressed.

#### Note:

- ◆ After pressing **[MENU]**, you can access only Menu 4-4.
- ◆ The Transporter will transmit its call sign in Morse code every 10 minutes, using the 144 MHz band.
- ◆ The APO timer will not operate on the transceiver while the Transporter is ON.
- ◆ You must set VHF frequency on the main transceiver and UHF frequency on the sub-receiver. Otherwise, the Sky Command II+ may not operate properly.
- ◆ When the TS-2000(X) exits the Sky Command II+ operation, the operating frequency of VFO A will be set to the VHF frequency that the Sky Command II+ was operated.

**USING TH-D7A AS A COMMANDER**

To use a TH-D7A transceiver as a “Commander” (an external remote control unit), follow the steps below. Basically, it is the same as using a TM-D700A as a “Commander” (described on the previous page).

**TS-2000(X) (Transporter) Setup:**

- 1 Press **[MENU]**, then turn the **MULTI/ CH** control to access Menu No. 62A.
- 2 Enter your callsign (ex: WD6DJY) as a “Commander” callsign, using **[+]/ [-]** or the **MULTI/ CH** control. To move the cursor, press **[MAIN]** or **[SUB]**. Press **[M.IN]** to store the callsign to Menu No. 62A.
- 3 Press **[MENU]**, then turn the **MULTI/ CH** control to access Menu No. 62B.
- 4 Enter your alias callsign (ex: WD6DJY-1) as a “Transporter” callsign, using **[+]/ [-]** or the **MULTI/ CH** control. To move the cursor, press **[MAIN]** or **[SUB]**. Press **[M.IN]** to store the callsign to Menu No. 62B.

**Note:** You can use alpha-numeric characters, A to Z, 0 to 9 and “-”. The callsign must be no more than 9 characters long including “-”. Also, the following callsign formats cannot be entered:

- *WD6DJYZ*  
If you use only letters and numbers for the callsign, the maximum length is 6 characters.
- *WD6-DJY-1*  
You cannot use more than 1 “-” within a callsign.
- *-WD6DJY*  
You cannot use a “-” as the first callsign character.
- *WD6DJY-19*  
An SSID must be within the range of 1 to 15.

- 5 Access Menu No. 62C, then turn the **MULTI/ CH** control to select a CTCSS tone frequency for Sky Commander II+ (default is 88.5 Hz).
- 6 Access Menu No. 62D and select the communication speed for Sky Commander II+. Select 1200 bps for TH-D7A (9600 bps can be used only when you use another TS-2000 as a “Commander”).
- 7 Assign the TNC band to the sub-band by accessing Menu No. 46 and select SUB.
- 8 Select a 144 MHz band frequency in FM mode on the main transceiver and 440 MHz band frequency in FM mode for the sub-receiver for Sky Command operation.

**TH-D7A (Commander) Setup:**

- 1 Access Menu 4–1 to enter the same callsign that you entered for the Commander (ex: WD6DJY).
- 2 Access Menu 4–2 to enter the same callsign that you entered for the Transporter (ex: WD6DJY-1).
- 3 Access Menu 4–3 to select the same CTCSS tone frequency that you selected for the TS-2000(X) (Transporter).

- 4 Set the same frequencies that you selected for the “Transporter” for the VHF and UHF bands.

**Note:** Refer to Chapter 19, Sky Command II, of the TH-D7A instruction manual for details on how to enter the callsign and CTCSS tone frequency.

**CONTROL OPERATION**

First, switch the TS-2000 transceiver ON and select T-PORTER (Transporter) from Menu 62E.

Then, access Menu 4–4 on the TH-D7A and select “COMMANDER”. “PUSH [0] KEY TO START COMMANDER!!” appears.

Press **[0]** on the TH-D7A to start Sky Command mode.

When in Sky Command mode, the keys of the TH-D7A (Commander) will function as described below. Only **[LAMP]**, **[MONI]**, and the **VOL** control functions will not change.

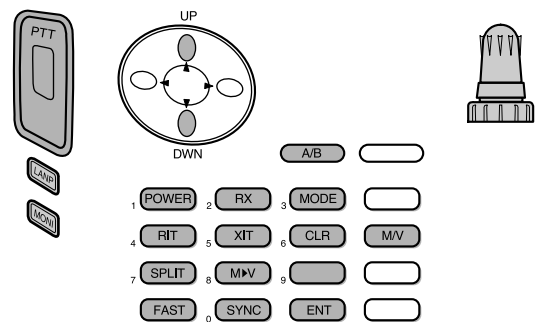

Each time you press the desired key, the Commander will automatically enter transmit mode and send the corresponding control command to the TS-2000 (Transporter).

To switch the HF transceiver OFF	Press <b>[POWER]</b> .
To transmit audio on a HF frequency	Press and hold the <b>PTT</b> switch, then speak into the microphone.
To receive audio on an HF frequency	Press <b>[RX]</b> .
To monitor the UHF band on the Commander	Press and hold <b>[MONI]</b> .

## 15 OPERATOR CONVENIENCES

Key	Function
<b>Tuning control</b>	Frequency or memory channel number change
<b>UP/ DWN</b>	RIT offset or XIT offset change
<b>A/B</b>	In VFO mode: VFO A/ VFO B switch In Memory Recall mode: no change
<b>POWER</b> <sup>1</sup>	Power ON/ OFF
<b>RX</b> <sup>1</sup>	HF frequency receive ON/ OFF
<b>MODE</b> <sup>1</sup>	Modulation mode switch
<b>RIT</b> <sup>1</sup>	RIT ON/ OFF
<b>XIT</b> <sup>1</sup>	XIT ON/ OFF
<b>CLR</b> <sup>1</sup>	RIT offset or XIT offset clear
<b>SPLIT</b> <sup>1</sup>	Split-frequency ON/ OFF
<b>M ↗ V</b> <sup>1</sup>	Transfer from Memory to VFO
<b>FAST</b>	In LSB, USB, or CW mode: 10 Hz/ 1 kHz switch In FM or AM mode: 1 kHz/ 10 kHz switch
<b>SYNC</b> <sup>1</sup>	Current settings retrieve (from HF transceiver)
<b>ENT</b>	In VFO mode: frequency entry ON In Memory Recall mode: channel number entry ON
<b>M/V</b>	VFO/ Memory Recall mode switch

<sup>1</sup> After pressing **[ENT]**, you can use these keys as numeric keys to enter a frequency or memory channel number.

When **[0/ SYNC]** is pressed, the Commander shows the current settings of the HF transceiver:

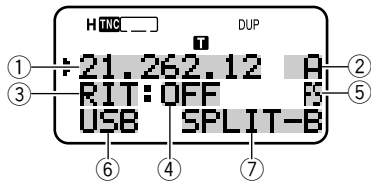

- ① HF frequency
- ② A (VFO A), B (VFO B),  
00 ~ 99 (memory channel number)
- ③ RIT, XIT
- ④ OFF, -9.99 ~ +9.99
- ⑤ "FS" appears when **[FAST]** is ON.
- ⑥ LSB, USB, CW, FM, or AM
- ⑦ SPLIT-A: VFO A is used for transmitting.  
SPLIT-B: VFO B is used for transmitting.  
SPLIT-M: A memory channel is used for transmitting.

### Note:

- ◆ On the Transporter, only **[LAMP]**, **[MONI]**, and **[MENU]** will function. Pressing any other key will simply cause the Transporter to generate an error beep.
- ◆ After pressing **[MENU]**, you can access only Menu 4-4.
- ◆ The Transporter will transmit its call sign in Morse code every 10 minutes, using the 144 MHz band.
- ◆ The APO timer will not operate on the transceiver while the Transporter is ON.



**USING ANOTHER TS-2000 AS A COMMANDER**

To use another TS-2000(X) transceiver as a “Commander” (an external remote control unit), follow the steps below. Basically, it is the same as using a TM-D700A as a “Commander” (described on pages 83 and 84).

**TS-2000(X) (Transporter) Setup:**

- 1 Press **[MENU]**, then turn the **MULTI/ CH** control to access Menu No. 62A.
- 2 Enter your callsign (ex: WD6DJY) as a “Commander” callsign, using **[+]/ [-]** or the **MULTI/ CH** control. To move the cursor, press **[MAIN]** or **[SUB]**. Press **[M.IN]** to store the callsign to Menu No. 62A.
- 3 Press **[MENU]**, then turn the **MULTI/ CH** control to access Menu No. 62B.
- 4 Enter your alias callsign (ex: WD6DJY-1) as a “Transporter” callsign, using **[+]/ [-]** or the **MULTI/ CH** control. To move the cursor, press **[MAIN]** or **[SUB]**. Press **[M.IN]** to store the callsign to Menu No. 62B.

*Note: You can use alpha-numeric characters, A to Z, 0 to 9 and “-”. The callsign must be no more than 9 characters long including “-”. Also, the following callsign formats cannot be entered:*

- *WD6DJYZ*  
*If you use only letters and numbers for the callsign, the maximum length is 6 characters.*
- *WD6-DJY-1*  
*You cannot use more than 1 “-” within a callsign.*
- *-WD6DJY*  
*You cannot use a “-” as the first callsign character.*
- *WD6DJY-19*  
*An SSID must be within the range of 1 to 15.*

- 5 Access Menu No. 62C, then turn the **MULTI/ CH** control to select a CTCSS tone frequency for Sky Command II+ (default is 88.5 Hz).
- 6 Access Menu No. 62D and select the communication speed for Sky Command II+.
  - Select 1200 bps or 9600 bps.
- 7 Access Menu No. 46 and select SUB.
- 8 Select a 144 MHz band frequency in FM mode on the main transceiver and 440 MHz band frequency in FM mode for the sub-receiver for Sky Command II+ operation.

**TS-2000 (Commander) Setup:**

- 1 Access Menu No. 62A and 62B to enter the same callsign that you entered for the TS-2000 (Transporter).
- 2 Access Menu No. 62C to select the same CTCSS tone frequency that you selected for the TS-2000 (Transporter).
- 3 Access Menu No. 62D and select the same communication speed that you selected for the TS-2000 (Transporter).
- 4 Access Menu No. 46 and select SUB.

- 5 Set the same frequencies that you selected for the “Transporter” for the main transceiver and sub-receiver.

**Starting Sky Command II+ operation:**

- 1 On the Transporter, access Menu No. 62E.
- 2 Select T-PORTER (Transporter).
- 3 On the Commander, access Menu No. 62E.
- 4 Select COMMANDER (Commander).
- 5 Press **[MAIN]** on the Commander to start the operation.

Control	Function
<b>MAIN</b> control	Turn to control the operating frequency.
<b>MULTI/ CH</b> control	Turn to control the operating frequency rapidly.
<b>[MAIN]</b>	Press to monitor the current receiving frequency.
<b>[SUB]</b>	Press to re-synchronize all the information between the transporter and commander.
<b>[+]/ [-]</b>	Press to move up or down the operating band (HF/ 50 MHz amateur radio bands).
<b>[VFO/ M]</b>	Press to toggle between VFO mode and Memory Recall mode.
<b>[ENT]</b>	Press to enter a desired frequency using the numeric keypad or a memory channel number in Memory Recall mode.
<b>[M ▶ VFO]</b>	Press to transfer the memory channel information to VFO.
<b>[A/B]</b>	Press to select VFO A or B.
<b>[SPLIT]</b>	Press to toggle SPLIT operation ON and OFF.
<b>[LSB/ USB]</b>	Press to select LSB or USB.
<b>[CW/ FSK]</b>	Press to select CW. FSK cannot be selected.
<b>[FM/ AM]</b>	Press to select FM or AM.
<b>[RIT]/ [XIT]</b>	Press to activate the RIT and/or XIT function.
<b>[CLEAR]</b>	Press to clear the offset frequency for RIT and/or XIT.
<b>[PROC]</b>	Press to switch the Speech Processor Function ON.
<b>[A.N.]</b>	Press to toggle the Auto Notch function ON and OFF.
<b>[B.C.]</b>	Press to toggle the Beat Cancel function ON and OFF.
<b>[N.R.]</b>	Press to select Noise Reduction 1, Noise Reduction 2, or OFF.
<b>[FUNC]. [AT]</b>	Press to toggle between ANT1 and ANT2 for HF/ 50 MHz band.
<b>[FUNC], [7/ NB/ LEVEL]</b>	Press to toggle the Noise Blanker function ON or OFF.
<b>[FUNC], [ϕ]</b>	Switch the Transporter power OFF.

## 15 OPERATOR CONVENIENCES

These keys and controls are available on the Commander to control the Transporter.

### Note:

- ◆ When the synchronize operation is incomplete, the main display of the Commander may disappear. In this case, press **[SUB]** to re-synchronize.
- ◆ You cannot recall memory channels 100 to 299 using **[ENT]** and the numeric keys. To recall memory channels 100 ~ 299, use **[+]/[-]**.
- ◆ You can recall only the memory channels that have HF/ 50 MHz frequencies.
- ◆ Do not use VHF/ UHF frequencies that are suffering from the harmonics of HF/ 50 MHz transmissions.
- ◆ The frequency control operations, such as the **Tuning** control and **RIT/ XIT** control, are much slower than using direct controls, because each control command (in steps of 10 Hz) is sent as packet data.
- ◆ When you change the frequency continuously, using the **Tuning** control or the **MULTI/ CH** control, the last entry of the Commander frequency is reflected on the HF/ 50 MHz transceiver.
- ◆ Since Sky Command II+ requires 2 VHF/ UHF frequencies, check the operating frequencies carefully to avoid interference with other parties.
- ◆ When the transceiver exits the Sky Command II+ operation, the internal TNC retains the data transfer speed in Menu No. 47. If a different data transfer speed is required for packet operation, reconfigure it to the desired value.

## USING A SEPARATE TRANSPORTER

If you have more than 2 TH-D7A and/or TM-D700A transceivers, you can use one of the transceivers as a "Transporter". This transceiver is connected to the TS-2000(X) via the RS-232C port, EXT SP jack, and Mic connector of the base station and the other TH-D7A or TM-D700A transceiver works as a "Commander". With this configuration, you can turn the TS-2000(X) ON and OFF using the "Commander". Refer to the instruction manual of the TH-D7A or TM-D700A for interfacing the transceiver to the TS-2000(X) transceiver.

### TS-2000 + TH-D7A/ TM-D700A (Transporter) Setup:

- 1 Configure the TH-D7A or TM-D700A as a "Transporter" and connect all the necessary cables to the TS-2000.
- 2 Select a frequency (HF/ 50 MHz band) on the main transceiver of the TS-2000.
- 3 On the TS-2000 Press **[MENU]**, then turn the **MULTI/ CH** control to access Menu No. 62E.
- 4 Select a "CLIENT".
- 5 Press **[MENU]** to complete.
- 6 Start the Transporter mode on the TH-D7A or TM-D700A.

### TH-D7A/ TM-D700A (Commander) Setup:

Configure the TH-D7A or TM-D700A as a "Commander". Refer to the SKY COMMAND II chapter in the instruction manual to set up the transceiver as a "Commander".

You can use a "Commander" as described on pages 84 and 86.

## REPEATER FUNCTION (K-type ONLY)

This transceiver is capable of receiving signals on one band and retransmitting them on another band. For example, a signal received on the sub-receiver is retransmitted on the main transceiver. Similarly, a signal received on the main transceiver can be retransmitted on the sub-receiver's frequency.

You can use any available frequency on the main transceiver or sub-receiver to receive and transmit. However, you cannot retransmit the received signals that are outside the available transmission frequencies. Additionally, you must use a different antenna for transmitting and receiving. For example, if you receive a VHF signal on the sub-receiver, you can retransmit it using UHF on the main transceiver. You cannot retransmit the signal using VHF of the main transceiver.

**Note:** For the repeater function to operate, the squelch levels of the main transceiver and sub-receiver must be adjusted so that no background noise can be heard.

## LOCKED-BAND REPEATER

The transceiver always uses the same band to receive, and retransmits the received signals on the other band.

- 1 Select a desired receive frequency on the sub-receiver.
- 2 Press **[MAIN]** and select a desired transmit frequency on the main transceiver.
- 3 Adjust the squelch threshold level so that both receivers mute.
- 4 Press **[MENU]**, then turn the **MULTI/ CH** control to access Menu No. 61A.
- 5 Select LOCKED, using **[+]**.
  - "LOCK  appears.

**Note:** You can also reverse the receive and transmit bands, so that you receive on the main transceiver and transmit on the sub-receiver's frequency.

## CROSS-BAND REPEATER

The cross-band repeater is unlike the lock-band repeater in that both bands can be used to receive signals. When a signal is received on one band, it is retransmitted on the other band. To activate the cross-band repeater, select CROSS in Menu No. 61A in step 5.

### Note:

- ◆ The Repeater function has its own Time-out Timer which is set at 3 minutes. This value cannot be changed.
- ◆ After activating the Repeater function, you cannot access Menu Nos. other than 61A and 61B.

## HANG TIME FOR REPEATER FUNCTION

If necessary, you can cause this transceiver to remain in the transmit mode for 500 ms after signals drop. Access Menu No. 61B and select "ON".

## DRU-3A DIGITAL RECORDING UNIT (OPTIONAL)

The optional DRU-3A unit allows you to record a voice message on up to 3 channels. After recording a message via your transceiver microphone, you can then send that message.

The maximum recording time for each channel is as follows:

- Channel 1: Approx. 30 seconds
- Channel 2: Approx. 15 seconds
- Channel 3: Approx. 15 seconds

The DRU-3A is useful in many situations:

- DX chasing or contest operation where repeated calls are necessary for extended periods of time.
- Checking interference complaints with other equipment (lets you be in two places at one time).
- Checking or adjusting your transmit signal or your antenna(s) if it's not convenient to be sitting in front of your microphone.
- Helping a friend adjust his/her antenna or receive when he/she needs repeated test transmissions.

For information on how to install the DRU-3A unit, refer to "INSTALLING OPTIONS" {page 97}.

### RECORDING MESSAGES

This section explains how to record a single message.

- 1 Select SSB, FM, or AM.
  - Use the same mode for transmitting and receiving.
- 2 If VOX is ON, press **[VOX/ LEVEL]** to switch the function OFF.
- 3 Press **[FUNC]**, **[1/ CH1/REC]** to record the message for channel 1.
  - "● II REC WAIT" and "AP1 -" appear.

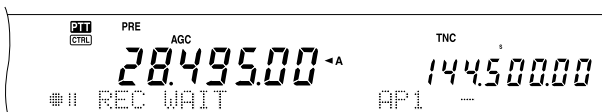

- To exit the Record Standby mode and quit recording your message, press **[CLR]**.
- 4 Press and hold **[1/ CH1/REC]**, then begin speaking into your microphone.
    - Three channels are available for recording messages. Press channel key **[2/ CH2/REC]** or **[3/ CH3/REC]** in place of **[1/ CH1/REC]**, in step 3, to record the message on a different channel.
  - 5 Release the key pressed in step 4 when you have finished recording your message.
    - Also when the maximum recording time passes, recording stops.
    - The content of the channel is overwritten with the new message.

- 6 Repeat steps 3 to 5 to record a message on another channel.

**Note:** Pressing **[ϕ]** (POWER) cancels recording in progress and clears the memory channel.

### MESSAGE PLAYBACK

You can play back the message in channel 1, 2, or 3 to check or to send. It is also possible to make a longer message, by consecutively playing back the messages of more than one channel, linking them together.

You can even repeatedly send a longer, linked message by using the Repeat function. To switch this function ON, access Menu No. 29A and select ON (Default is OFF). Then, select the repeat interval time in Menu No. 29B (Default is 10 seconds).

**Note:**

- ◆ Pressing **[ϕ]** (POWER) cancels playback in progress.
- ◆ The settings in Menu Nos. 29A and No. 29B are shared with CW Message Playback described in "CW MESSAGE MEMORY" {page 43}.

### ■ Checking Messages

- 1 Select SSB, FM, or AM.
  - Use the same mode for transmitting and receiving.
- 2 If VOX is ON, press **[VOX/ LEVEL]** to switch the function OFF.
- 3 Press **[1/ CH1/REC]**, **[2/ CH2/REC]**, or **[3/ CH3/REC]**, depending on which channel you want to check.
  - For example, "▶ PLAY BACK" and "AP 1--" appear while playing back the message in channel 1.
- To interrupt playback, press **[CLR]**.
- 4 To play back another message in sequence, press the corresponding key (**[1/ CH1/REC]**, **[2/ CH2/REC]**, or **[3/ CH3/REC]**) while the first message is being played.
  - Up to three channels can be queued.

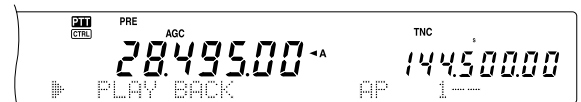

## 15 OPERATOR CONVENIENCES

### ■ Sending Messages

- 1 Select SSB, FM, or AM.
  - Use the same mode for transmitting and receiving.
- 2 Press **[VOX/ LEVEL]** to switch VOX ON or OFF.
  - If you switched VOX ON, skip step 3.
- 3 Press **[SEND]**, or press and hold Mic **[PTT]**.
- 4 Press **[1/ CH1/REC]**, **[2/ CH2/REC]**, or **[3/ CH3/REC]**, depending on which channel you want to use.
  - For example, “▶ PLAY BACK” and “AP 1—” appear while playing back the message in channel 1.



- To interrupt playback, press **[CLR]**.
- 5 To play back another message in sequence, press the corresponding key (**[1/ CH1/REC]**, **[2/ CH2/REC]**, or **[3/ CH3/REC]**) while the first message is being played.
    - Up to 3 channels can be queued.
  - 6 If you pressed **[SEND]** or Mic **[PTT]** in step 3, press **[SEND]** again or release Mic **[PTT]**.

### ■ Erasing a Recorded Message

- 1 Press **[FUNC]** then **[1/ CH1/REC]** or **[2/ CH2/REC]** or **[3/ CH3/REC]** to select the message which you want to erase.
  - “● II REC WAIT” and “APn —” appear, where “n” represents the channel number.
- 2 To erase the recorded message, press and hold the same key as in step 1 (**[1/ CH1/REC]**, **[2/ CH2/REC]**, or **[3/ CH3/REC]**), and press **[CLR]** at the same time.
  - A beep sounds and the message is erased.

### ■ Changing Inter-message Interval Time

For repetitive message playback, you can change the interval between each series of messages. Use Menu No. 29B, and select the time in the range of 0 to 60 seconds.

### ■ Changing Playback Volume

Turning the **MAIN AF** or **SUB AF** control does not change the volume for playback. To change the volume, access Menu No. □14 to select the playback volume level from OFF and 1 to 9.

### VS-3 VOICE SYNTHESIZER (OPTIONAL)

Install the optional VS-3 unit to use this function. Each time you change the transceiver mode such as VFO A/B or Memory Recall, the transceiver automatically announces the new mode. In addition, you can program the front panel **[PF]** key so that pressing it makes the transceiver announce the displayed information. If you have the optional MC-47 microphone, you can program one of the Mic **[PF]** keys for this function as well.

For an explanation on how to install the VS-3 unit, refer to "INSTALLING OPTIONS" {page 97}.

The table below indicates what the transceiver automatically announces when it changes the settings.

Key Pressed	Operation	Announcement
<b>[A/B]</b>	VFO A	VFO + frequency
	VFO B	
<b>[+], [-]</b>	Band change	
<b>[CALL]</b>	Call channel	Call + frequency
<b>[VFO/ M]</b>	VFO or Memory Recall	VFO + frequency or MR + Memory No. + frequency
<b>[MENU]/ [+], [-]</b>	Menu No. selection	Menu + No. + Selected number/ parameter
<b>[M.IN]</b>	Memory Scroll mode	MR + Channel + Memory No. (3-digit) + Frequency
<b>[ENT]</b>	Frequency entry	Enter
<b>MULTI/ CH control</b>	Menu No. changes	Menu + No. + Selected number/ parameter
	Memory channel No. changes	MR + Memory channel No. + frequency
<b>Numeric key entry</b>	Entering numbers	Every number entered
<b>[.]</b>	During the frequency entry	Mega hertz

**Note:** The PF key assignment parameter is announced as the number shown below.

Menu number	63	VOICE1	64	VOICE2	65	RX MONI	
66	DSP MONI	67	QUICK MR	68	QUICK M.IN	69	SPLIT
70	TF-SET	71	A/B	72	VFO/ M	73	A=B
74	SCAN	75	M>VFO	76	M.IN	77	CW TUNE
78	CH1	79	CH2	80	CH3	81	FINE
82	CLR	83	CALL	84	CTRL	85	1MHz
86	ANT1/2	87	NB	88	N.R.	89	B.C.
90	A.N.	99	OFF				

For the **[PF]** key, the transceiver will announce different information, depending on whether VOICE1 or VOICE2 is selected.

#### VOICE1:

- VFO or memory channel frequencies are announced beginning with the 10 MHz digit and continuing through to the 10 Hz digit. If the memory channel has no data stored, "open" is announced. For the MHz decimal point, "point" is announced. For the kHz decimal point, a short pause (200 ms) is made. A 200 ms pause is also made between the channel number and the frequency.
- Menu numbers and their settings are announced with a short pause (200 ms) between the menu number and the setting.

**Note:** If operating a key or a control changes the contents of the display while an announcement is in progress, the announcement is interrupted.

#### VOICE2:

- The S-meter readings at the time you pressed the key, are announced, for example, "S5" or "20 dB".

The table below shows the available announcements when the **[PF]** (VOICE2) is pressed.

MAIN		SUB	
S-Meter Level	Announcement	S-Meter Level	Announcement
1 ~ 3	S1	1	S1
4 ~ 5	S2	2	S2
6	S3	3	S3
7~ 8	S4	4	S4
9	S5	5	S5
10 ~ 11	S6	6	S6
12	S7	7	S7
13 ~ 14	S8	8	S8
15	S9	9	S9
16 ~ 18	10 dB	10	10 dB
19 ~ 20	20 dB	11	20 dB
21 ~ 22	30 dB	12	30 dB
23 ~ 25	40 dB	13	40 dB
26 ~ 28	50 dB	14	50 dB
29 ~ 30	60 dB	15	60 dB

1 Assign VOICE1 (63) or VOICE2 (64) to the front panel **[PF]** key by accessing Menu No. 51A. Or, if you are using the optional MC-47 (or MC-52DM) microphone, assign one of the Mic **[PF]** keys to either VOICE1 or VOICE2. For programming Mic **[PF]** keys, refer to "MICROPHONE PF KEYS" {page 77}.

2 Press the **[PF]** key that you programmed.

- An announcement is made based on the VOICE1 or VOICE2 selection.
- To interrupt the announcement, press the **[PF]** key again.

---

## 15 OPERATOR CONVENIENCES

---

### MICROPROCESSOR RESET

If your transceiver seems to be malfunctioning, resetting the microprocessor default settings may resolve the problem. There are 2 levels of resetting the microprocessor of the TS-2000(X): partial reset and full reset.

#### INITIAL SETTINGS

For each VFO, the factory defaults for the operating frequency and mode are as follows:

- MAIN VFO A: 14.000.000 MHz/ USB
- MAIN VFO B: 14.000.000 MHz/ USB
- SUB VFO: 144.000.00 MHz/ FM

The Memory channels and Quick Memory channels have no data stored.

#### PARTIAL RESET

Perform a Partial Reset if a key or control does not function according to the instructions in this manual. The following data is NOT erased by performing a Partial Reset.

- Memory channel data
- Menu settings
- Antenna tuner preset data
- ANT 1/ANT 2 data

Reset the transceiver by pressing **[A/B]+[ϕ]**.

- A confirmatin message appears. Press **[A/B]** to proceed. Otherwise, press any other key to cancel the Partial Reset and return to normal operation.
- "HELLO" appears on the display and the VFOs resets to the factory default values.

#### FULL RESET

Perform a Full Reset if you want to erase all the data in all the memory channels. In addition, this function resets all the settings that you customized, to the factory defaults (i.e.- menu settings, antenna tuner preset data, etc.).

Reset the transceiver by pressing **[A=B]+[ϕ]**.

A confirmation message appears when performing the Full Reset. Press **[A=B]** to proceed. Otherwise, press any other key to cancel the Full Reset and return to normal operation.

When you perform the full reset:

- "HELLO" appears on the display.
- All frequencies, modes, memory data and AT preset data are set to the factory default values (refer to "INITIAL SETTINGS", above).

# CONNECTING PERIPHERAL EQUIPMENT

## COMPUTER

The **COM** connector allows you to directly connect a computer or dumb terminal by using an RS-232C cable terminated with a 9-pin female connector.

No external hardware interface is required between your computer and the transceiver. See "APPENDIX" {page 113} for information related to this connector.

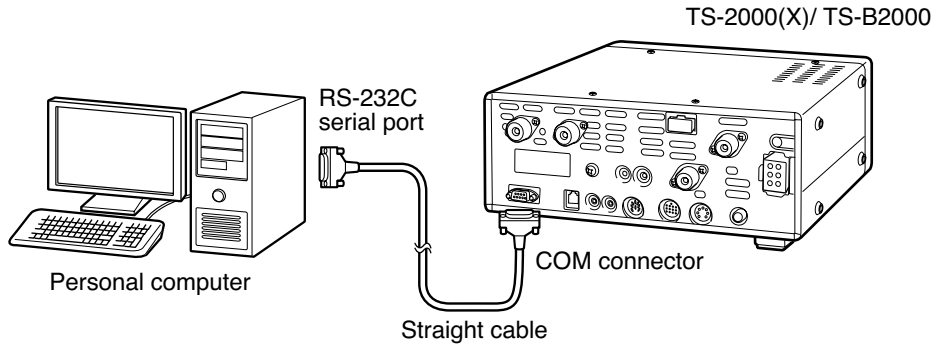

## COMPATIBLE TRANSCEIVER

When transferring data to or from another TS-2000(X), TS-990S, TS-590, TS-570, or TS-870S, directly connect the two transceivers using the **COM** connectors.

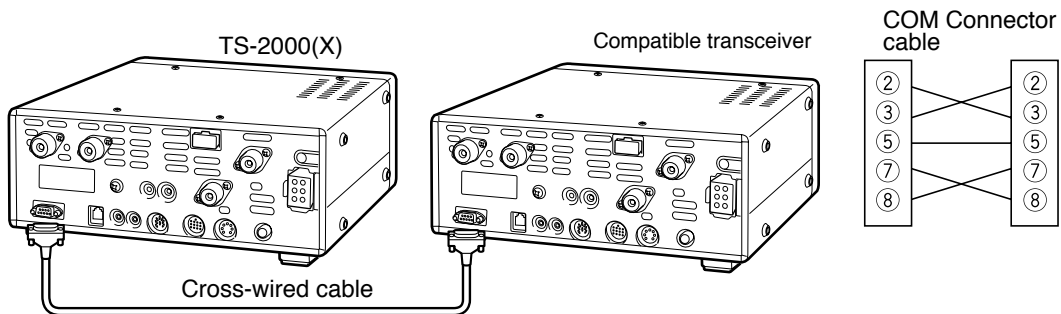

## 16 CONNECTING PERIPHERAL EQUIPMENT

### RTTY EQUIPMENT

Use the **ACC 2** connector to connect to the RTTY equipment. Connect the RTTY key output line to pin 2 of the **ACC 2** connector. Connect the demodulation input line of the RTTY equipment to pin 3 of the **ACC 2** connector {page 95}.

**Note:** Do not share a single power supply between the transceiver and the RTTY equipment. Keep as wide a separation as possible between the transceiver and the RTTY equipment to reduce noise-pickup by the transceiver.

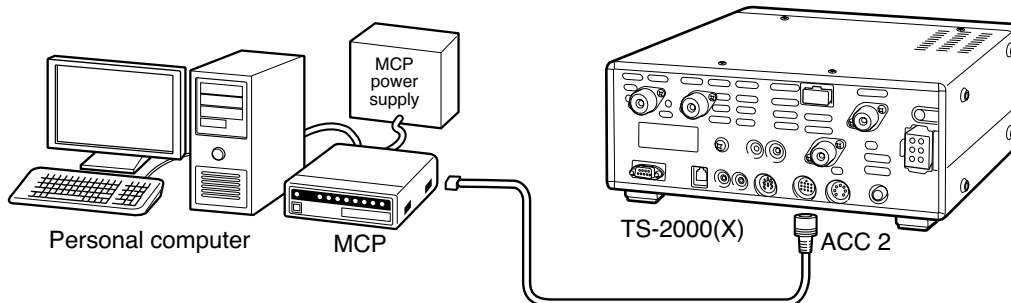

### HF LINEAR AMPLIFIER

Connect an external transmit power amplifier to the **REMOTE** connector (1 male **REMOTE** connector (E07-0751-XX) is supplied). Switch ON the linear amplifier control relay via Menu No. 28A.

The TX/RX relay response time is 10 ms when you have selected CW Full Break-in and 25 ms when you have selected CW Semi Break-in.

**Note:** The TX/RX control method differs, depending on external amplifier models. Some amplifiers enter the TX mode when the control terminal is grounded. For those amplifiers, connect pin 2 of the **REMOTE** connector to the GND terminal of the amplifier and connect pin 4 of the connector to the control terminal of the amplifier.

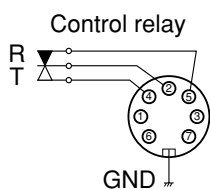
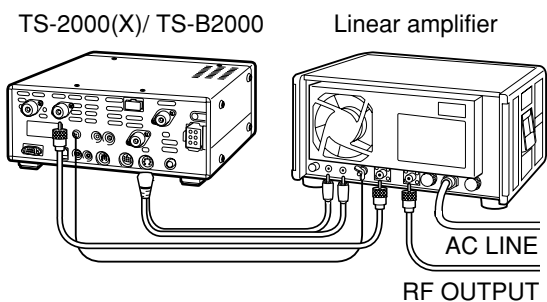

REMOTE Connector  
(Rear panel view)

The TL-922 linear amplifier is a discontinued model. It may no longer be available in your area.

REMOTE connector

Pin No.	Function
1	Speaker output
2	Common terminal
3	Standby; when grounded, the transceiver enters TX mode.
4	When connected with the common terminal, the amplifier enters TX mode.
5	When connected with the common terminal, the amplifier enters RX mode.
6	ALC input from amplifier
7	Approx. +12 V DC is output when in TX mode (10 mA max.).

### ANTENNA TUNER

Use the **ANT 1** and **AT** connectors to connect an external antenna tuner. If you connect the external tuner to the **ANT 2** connector, the external tuner will not function.

**Note:** While using an external antenna tuner with the TS-2000(X)/TS-B2000, you cannot use the 6 m band to transmit. Connect your 6 m band antenna to the **ANT 2** connector.

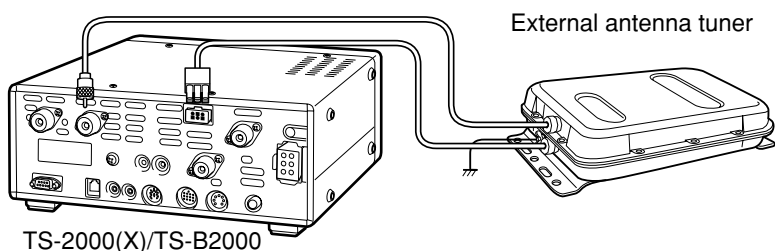

The AT-300 external antenna tuner is a discontinued model. It may no longer be available in your area.



## MCP AND TNC

Use the **ACC 2** connector to connect the input/output lines from a Terminal Node Controller (TNC) for Packet operation, a Multimode Communications Processor (MCP) for operation on Packet, PacTOR, AMTOR, G-TOR™, PSK31, or FAX, or from a Clover interface. Also use the **ACC 2** connector to connect SSTV and phone patch equipment (1 male ACC2 connector (E07-1351-XX) is supplied).

- Connect the TNC or MCP to the **ACC 2** connector using a cable equipped with a 13-pin DIN plug.
- Connecting the TNC or MCP to a personal computer or dumb terminal requires an RS-232C cable.

**Note:** Do not share a single power supply between the transceiver and the TNC or MCP. Keep as wide a separation as possible between the transceiver and the computer to reduce noise-pickup by the transceiver.

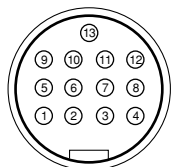

**ACC2**  
Front view  
(Rear panel)

Pin No.	Pin Name	Function
1	SANO	AF output from the sub-receiver <ul style="list-style-type: none"> <li>• Connect to the TNC or MCP receive data pin for digital operation.</li> <li>• AF output level is independent from SUB AF control setting.</li> <li>• AF output level can be changed by adjusting the Menu No. 50D value.</li> <li>• Output impedance: Approx. 10kΩ.</li> </ul>
2	RTTY	RTTY key input
3	MANO	AF output from the main transceiver <ul style="list-style-type: none"> <li>• Connect to the TNC or MCP receive data pin for digital operation.</li> <li>• AF output level is independent from the MAIN AF control setting.</li> <li>• AF output level can be changed by adjusting the Menu No. 50C value.</li> <li>• Output impedance: Approx. 10kΩ.</li> </ul>
4	GND	Ground
5	MSQ	Main transceiver squelch control <ul style="list-style-type: none"> <li>• Connect to the TNC or MCP squelch control pin for digital operation.</li> <li>• Prevents the TNC from transmitting while the transceiver squelch is open.</li> <li>• Squelch open: Low impedance</li> <li>• Squelch closed: High impedance</li> </ul>
6	NC	No connection
7	SSQ	Sub-receiver squelch control <ul style="list-style-type: none"> <li>• Connect to the TNC or MCP squelch control pin for digital operation.</li> <li>• Prevents the TNC from transmitting while the transceiver squelch is open.</li> <li>• Squelch open: Low impedance</li> <li>• Squelch closed: High impedance</li> </ul>
8	GND	Ground
9	PKS	Transceiver PTT line control <ul style="list-style-type: none"> <li>• Ground this terminal to transmit.</li> <li>• Connect to the TNC or MCP transmit/ receive switching pin for digital operation.</li> <li>• Microphone audio input mutes when the transceiver transmits.</li> </ul>
10	NC	No connection
11	PKD	Microphone audio input <ul style="list-style-type: none"> <li>• Connect to the TNC or MCP transmit data pin for digital operation.</li> </ul>
12	GND	Ground
13	SS	PTT control <ul style="list-style-type: none"> <li>• Ground this terminal to transmit.</li> <li>• For connecting a footswitch or other external controller (in parallel with MIC jack).</li> <li>• Microphone audio input does NOT mute when the transceiver transmits.</li> </ul>

# 16 CONNECTING PERIPHERAL EQUIPMENT

## TYPICAL MCP/ TNC SETUP

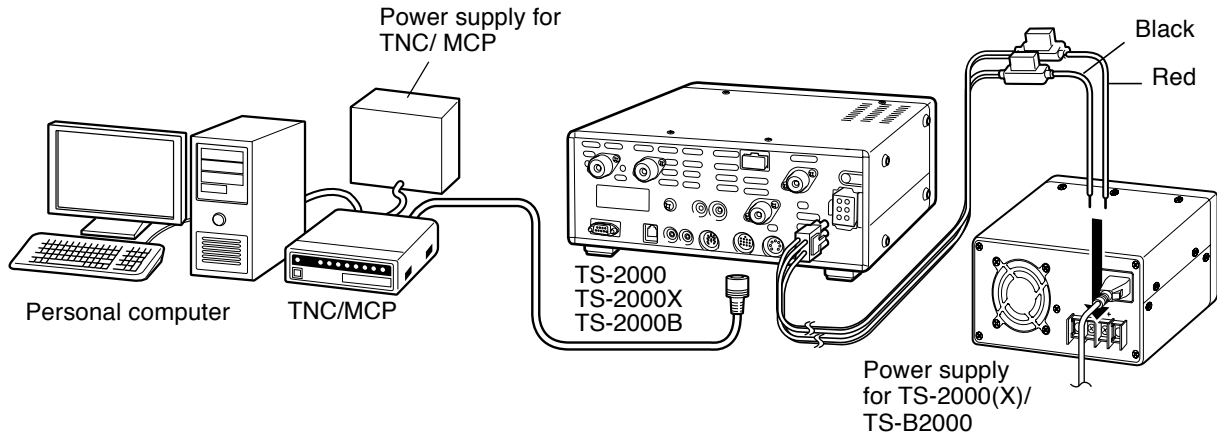

## LINEAR AMPLIFIER (50 MHz, VHF, UHF and 1.2 GHz)

Connect an external 50 MHz/ VHF/ UHF/ 1.2 GHz power amplifier control cable to the **EXT.CONT** connector (1 male **EXT.CONT** connector (E07-0851-XX) is supplied). The TX/RX switching time can be configured independently for each band, accessing Menu Nos. 28B ~ 28E. Select 1 for 10 ms delay or 2 for 25 ms delay. However, when CW Full Break-in is enabled, 10 ms switching delay is applied automatically regardless of the settings. You can also disable the **EXT.CONT** control, selecting OFF (default).

**Note:** The TX/RX control method differs, depending on external amplifier models. Most amplifiers enter the TX mode when the control terminal is grounded. For those amplifiers, connect the metal cover of the **EXT.CONT** connector to the GND terminal of the amplifier and connect pin 2 (50 MHz), pin 6 (144 MHz), pin 1 (430/ 440 MHz), or pin 4 (1.2 GHz) of the connector to the control terminal of the amplifier.

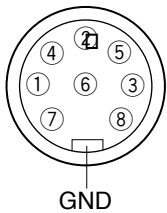

**EXT.CONT**  
Front view  
(Rear panel)

Circuit of each TXC (pin 1, 2, 4, and 6)

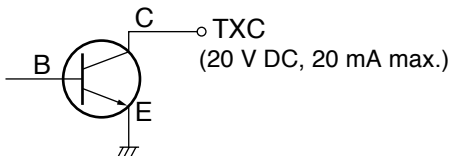

Circuit of ALC inputs (pin 3, 5, 7, and 8)

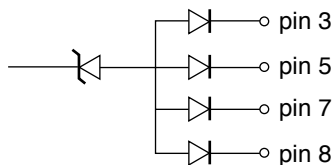

**EXT.CONT** connector

Pin No.	Pin Name	Function
1	43TXC	Grounded when the transceiver transmits on the 430/ 440 MHz band. (DC 20 V, 20 mA max.)
2	50TXC	Grounded when the transceiver transmits on the 50 MHz band. (DC 20 V, 20 mA max.)
3	ALC	50 MHz ALC input from amplifier (-7 V).
4	12TXC	Grounded when the transceiver transmits on the 1.2 GHz band. (DC 20 V, 20 mA max.)
5	ALC	430 (440) MHz ALC input from amplifier (-7 V).
6	14TXB	Grounded when the transceiver transmits on the 144 MHz band. (DC 20 V, 20 mA max.)
7	ALC	1.2 GHz ALC input from amplifier (-7 V).
8	ALC	144 MHz ALC input from amplifier (-7 V).
Metal cover	GND	Ground

# INSTALLING OPTIONS

You will require a Phillips screwdriver when installing the optional units.

## REMOVING THE BOTTOM CASE

When installing the optional DRU-3A or VS-3 unit, remove the bottom case first.

- 1 Remove the 10 screws.

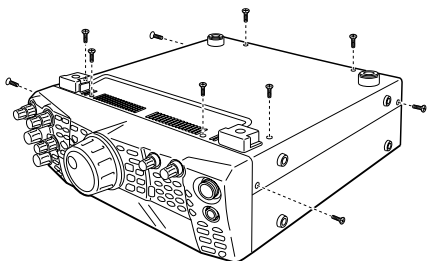

- 2 Lift off the bottom case.

## DRU-3A DIGITAL RECORDING UNIT

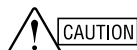

SWITCH OFF THE POWER AND UNPLUG THE DC POWER CABLE BEFORE BEGINNING INSTALLATION.

- 1 Remove the bottom case (10 screws).
- 2 Locate the DRU-3A connector.
- 3 Peel off the paper on the cushion attached to the PC board of the transceiver.

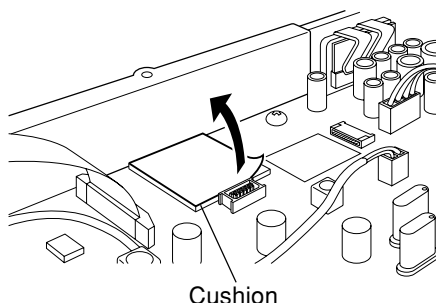

- 4 Plug the DRU-3A into the DRU-3A connector of the PC board.
- 5 Press the top of the DRU-3A to affix it to the cushion.

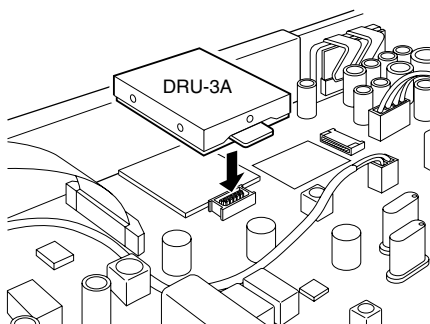

- 6 Replace the bottom case (10 screws).

**Note:** After the installation, you can adjust the DRU-3A playback volume by selecting Menu No. 14.

## VS-3 VOICE SYNTHESIZER UNIT



SWITCH OFF THE POWER AND UNPLUG THE DC POWER CABLE BEFORE BEGINNING INSTALLATION.

- 1 Remove the bottom case (10 screws).
- 2 Locate the VS-3 jack.
- 3 Hold the VS-3 unit with the component side facing up, and insert the VS-3 connector into the VS-3 jack.

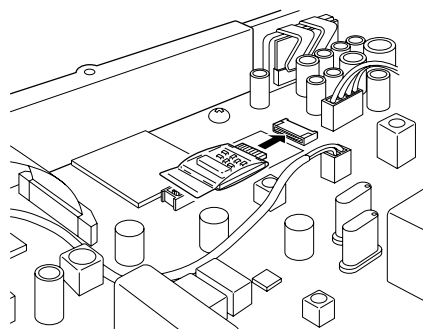

- 4 Replace the bottom case (10 screws).

**Note:** After the installation, you can adjust the VS-3 playback volume by selecting Menu No. 15.

## 17 INSTALLING OPTIONS

### MB-430 MOBILE BRACKET

When installing the MB-430, attach the supplied plastic spacers (G11-2698-XX) to the transceiver in advance. This is necessary to protect the TS-2000(X)/ TS-B2000 transceiver from scratches.

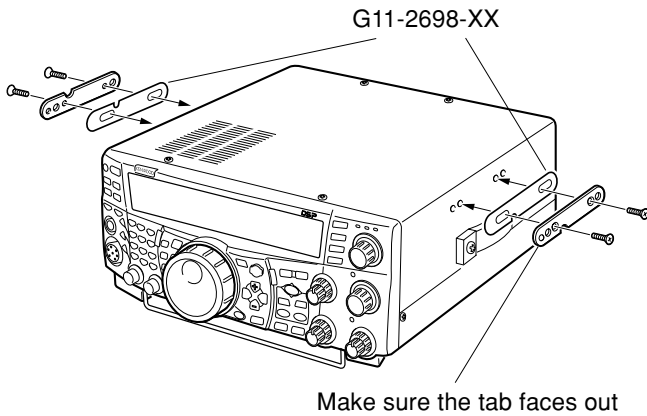

Once the bracket is installed onto the vehicle, prepare the transceiver by loosely screwing in the rear screws. Hook those screws onto the rear guide rail of the mounting bracket then adjust the transceiver to your desired angle before tightening the screws. Insert and tighten the front screws to secure the transceiver in place.

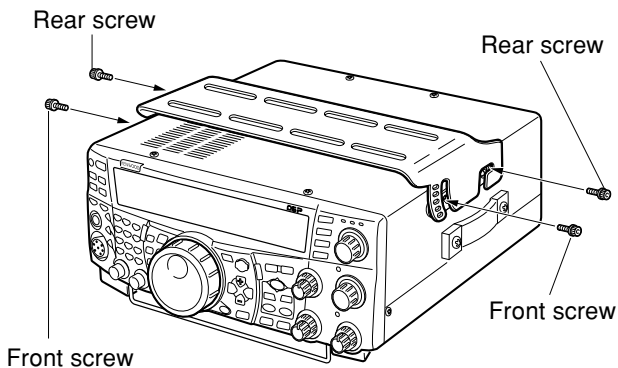

To remove the transceiver from the bracket, first remove the front screws, then loosen the rear screws slightly and pull the transceiver forward to unlatch it from the bracket.

**WARNING**  
*Do not install the transceiver so that it is vertically on its side.*

### RC-2000 REMOTE PANEL

Plug the modular cable from the RC-2000 into the PANEL connector on the TS-2000(X)/ TS-B2000 rear panel. Access Menu Nos. 58 ~ 60 to adjust the panel configuration if necessary.

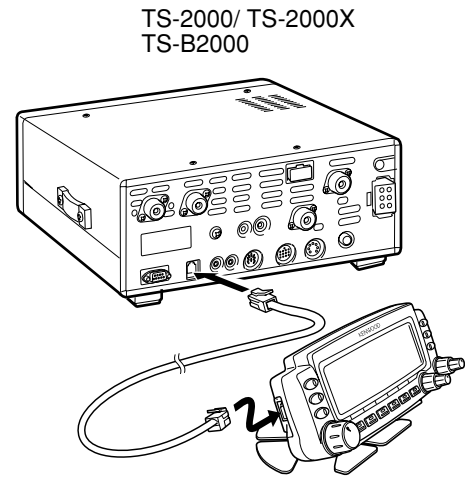

## GENERAL INFORMATION

Your transceiver has been factory aligned and tested to specification before shipment. Under normal circumstances, the transceiver will operate in accordance with these operating instructions. All adjustable trimmers, coils and resistors in the transceiver were preset at the factory. They should only be readjusted by a qualified technician who is familiar with this transceiver and has the necessary test equipment. Attempting service or alignment without factory authorization can void the transceiver warranty.

When operated properly, the transceiver will provide years of service and enjoyment without requiring further realignment. The information in this section gives some general service procedures requiring little or no test equipment.

## SERVICE

If it is ever necessary to return the equipment to your dealer or service center for repair, pack the transceiver in its original box and packing material. Include a full description of the problems experienced. Include both your telephone number and fax number (if available) along with your name and address in case the service technician needs to call for further explanation while investigating your problem. Don't return accessory items unless you feel they are directly related to the service problem.

You may return your transceiver for service to the authorized **KENWOOD** dealer from whom you purchased it or any authorized **KENWOOD** service center. A copy of the service report will be returned with the transceiver. Please do not send subassemblies or printed circuit boards. Send the complete transceiver.

Tag all returned items with your name and call sign for identification. Please mention the model and serial number of the transceiver in any communication regarding the problem.

## SERVICE NOTE

If you desire to correspond on a technical or operational problem, please make your note short, complete, and to the point. Help us help you by providing the following:

- 1 Model and serial number of equipment.
- 2 Question or problem you are having.
- 3 Other equipment in your station pertaining to the problem.
- 4 Meter readings.
- 5 Other related information (Menu setup, mode, frequency, key sequence to induce malfunction, etc.).

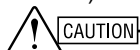

CAUTION

DO NOT PACK THE EQUIPMENT IN CRUSHED NEWSPAPERS FOR SHIPMENT! EXTENSIVE DAMAGE MAY RESULT DURING ROUGH HANDLING OR SHIPPING.

### Note:

- ◆ Record the date of purchase, serial number and dealer from whom the transceiver was purchased.
- ◆ For your own information, retain a written record of any maintenance performed on the transceiver.
- ◆ When claiming warranty service, please include a photocopy of the bill of sale, or other proof-of-purchase showing the date of sale.

## CLEANING

The keys, controls and case of the transceiver are likely to become soiled after extended use. Remove the controls from the transceiver and clean them with a neutral detergent and warm water. Use a neutral detergent (no strong chemicals) and a damp cloth to clean the case.

## LITHIUM BATTERY

This transceiver uses an EEPROM to store memory channel data, menu configurations and all necessary operation parameters. So, you never have to worry about replacing batteries to operate the transceiver.

However, the transceiver's built-in TNC requires a lithium battery (CR-2032) to store the TNC data. Battery lifetime varies, but under normal operating conditions, it should last for approximately 5 years. If you find that the TNC no longer stores the TNC parameters, contact an authorized **KENWOOD** service center for replacing the lithium battery.

## DEMONSTRATION MODE

The transceiver can be configured to enter the demonstration mode for display purposes. To enter the demonstration mode:

- 1 Switch the transceiver OFF.
- 2 Press **[FUNC]+[ϕ]** to switch the transceiver ON.
  - On the dot-matrix display windows, you will see a few killer whales jump across the display. You will also notice the display brightness changes and LEDs turn ON and OFF automatically.
  - If you operate the transceiver while in the demonstration mode, the demonstration is temporarily paused. But, if no operation is performed for more than 10 seconds, the demonstration starts again.
- 3 To exit the demonstration mode, first turn the transceiver OFF, then press **[FUNC]+[ϕ]** to turn the transceiver ON.

**Note:** You cannot exit the demonstration mode by simply switching the transceiver OFF or performing a full reset (page 92). You must switch the transceiver OFF then press **[FUNC]+[ϕ]** to turn the transceiver ON in order to exit the demonstration mode.

## 18 TROUBLESHOOTING

### TROUBLESHOOTING

The problems described in this table are commonly encountered operational malfunctions. These types of difficulties are usually caused by improper hook-up, accidental incorrect control settings, or operator error due to incomplete programming. These problems are usually not caused by circuit failure. Please review this table, and the appropriate section(s) of this instruction manual, before assuming your transceiver is defective.

**Note:** *Placing a powered portable transceiver near this transceiver may cause noise in the transceiver.*

Problem	Probable Cause	Corrective Action	Page Ref.
The transceiver will not power up after connecting a 13.8 V DC power supply and pressing [ϕ]. Nothing appears on the display, and no receiver noise is heard.	1 DC power supply is OFF.	1 Switch ON the DC power supply.	2
	2 Faulty power cable.	2 Inspect the power cable. Confirm polarities are correct. Red: positive (+); Black: negative (-)	2
	3 The power cable is not connected securely.	3 Confirm the connections to the DC power supply are secure.	2
	4 Power cable fuse is open.	4 Look for the cause of the blown fuse. After inspecting and correcting any problems, install a new fuse of the specified rating.	2
After switching ON the power, the transceiver does not function normally. For example, no digits or incorrect digits appear on the display.	1 The input voltage is outside 13.8 V DC ±15% (11.7 to 15.8 V DC).	1 Correct the input voltage or use a 12 to 16 V battery.	2
	2 The microprocessor has malfunctioned.	2 Review "MICROPROCESSOR RESET". After understanding what data will be lost, do a Partial Reset. If the problem remains, do a Full Reset.	92
After switching ON the transceiver, the internal TNC resets to the factory default values.	The internal TNC backup lithium battery voltage is too low.	Have a new battery installed by your dealer or at a <b>KENWOOD</b> Service Center.	99
The transceiver does not respond correctly after pressing key combinations or turning controls per instructions in this manual.	1 Procedures are not being followed precisely.	1 Review "WRITING CONVENTIONS FOLLOWED".	i
	2 The Frequency Lock function is ON.	2 Press <b>[FUNC], [ATT/ F LOCK]</b> to switch the function OFF.	77
	3 The microprocessor and its memory need resetting.	3 Review "MICROPROCESSOR RESET". After understanding what data will be lost, do a Partial Reset. If the problem remains, do a Full Reset.	92
	4 The keys on the transceiver are unavailable while operating the Tuning control.	4 Stop operating the Tuning control, then press the appropriate keys.	–
The frequency cannot be changed.	The Frequency Lock function or Lock All function is ON.	Press <b>[FUNC], [ATT/ F LOCK]</b> to switch the function OFF.	77
		Or press <b>[FUNC], [PRE/ LOCK A]</b> to switch the function OFF.	77
SSB audio quality is very poor; the high or low audio frequencies are absent.	1 The wrong operation mode is selected for the receiver.	1 Select USB or LSB for the mode.	28
	2 The <b>LO/ WIDTH</b> control or <b>HI/ SHIFT</b> control is incorrectly set.	2 Turn the <b>LO/ WIDTH</b> control counterclockwise and the <b>HI/ SHIFT</b> control clockwise.	55
	3 Noise Reduction 1 or 2 is ON.	3 Press <b>[N.R./ LEVEL]</b> to switch the function OFF.	56
	4 Beat Cancel is ON.	4 Press <b>[B.C./ MANUAL]</b> to switch the function OFF.	56

Problem	Probable Cause	Corrective Action	Page Ref.
No signals are received or receive sensitivity seems poor.	1 The <b>SQL</b> control is fully clockwise.	1 Turn the <b>SQL</b> control counterclockwise.	19
	2 The Attenuator function is ON.	2 Press <b>[ATT/ F LOCK]</b> to switch the function OFF.	57
	3 <b>[SEND]</b> was pressed, and the transceiver is now in transmit mode. Or, Mic <b>[PTT]</b> is pressed.	3 Press <b>[SEND]</b> to return to receive mode. Or release Mic <b>[PTT]</b> .	–
	4 The receive bandwidth was incorrectly set.	4 Review “DSP FILTERS” and “CHANGING THE RECEIVE FILTER BANDWIDTH”, and set the controls accordingly.	55
	5 The wrong antenna connector (ANT 1 or ANT 2) was selected.	5 Press <b>[FUNC]</b> , <b>[AT/ ANT1/2]</b> to select the other antenna connector.	72
	6 The receive preamplifier is OFF.	6 Press <b>[PRE/ LOCK A]</b> to switch the function ON.	57
No signals are received or receive sensitivity seems poor; S-meter is reading full scale.	The RF control was set too low.	Turn the <b>MAIN RF GAIN</b> control fully clockwise.	18
Received signals are totally unintelligible.	The wrong modulation mode was selected.	Press <b>[LSB/ USB/ AUTO]</b> , <b>[CW/ FSK/ REV]</b> , or <b>[FM/ AM/ NAR]</b> to select the correct modulation mode.	19
Memory Scan will not start scanning.	1 The <b>SQL</b> control was not set correctly.	1 Adjust the <b>SQL</b> controls to just eliminate background noise.	19,46
	2 Less than two memory channels were unlocked.	2 Unlock at least two memory channels.	68
	3 Less than two memory channels were programmed.	3 Store data in at least two memory channels.	68
	4 The <b>SQL</b> control was not set correctly.	4 Adjust the <b>SQL</b> controls.	19,46
Memory Scan will not scan one of the stored channels; the desired channel is NOT locked out.	With Group Scan selected, the channel you want to scan is in a different group.	Select the group that contains the memory channel you want to scan.	69
Program Scan will not start scanning.	The start and end frequencies are identical.	Store different start and end frequencies.	62
Tuning does not finish successfully.	The impedance of the coaxial cable and antenna was not matched. Tuning does not successfully finish depending on conditions although the SWR meter indicates smaller than 3:1.	Adjust the antenna system to lower the SWR.	1
The internal tuner is bypassed immediately after tuning is started.	The SWR of the antenna system is too high.	Adjust the antenna system to lower the SWR.	1
You cannot transmit even though you press Mic <b>[PTT]</b> or transmissions result in no contacts.	1 The microphone plug was not inserted completely into the MIC connector.	1 Turn OFF the power, ensure the MIC connector has no foreign objects in it, then plug in the connector firmly.	3
	2 The Transmit Inhibit function is ON.	2 Change Menu No. 54 to OFF.	41
	3 CW or FSK was selected instead of a voice mode.	3 Press <b>[LSB/ USB/ AUTO]</b> or <b>[FM/ AM/ NAR]</b> to select a voice mode.	19
	4 The DSP TX filter bandwidth was improperly selected.	4 Adjust the settings in Menu No. 22.	41
	5 The wrong antenna connector (ANT 1 or ANT 2) was selected.	5 Press <b>[FUNC]</b> , <b>[AT/ ANT1/2]</b> to select the other antenna connector.	72

## 18 TROUBLESHOOTING

Problem	Probable Cause	Corrective Action	Page Ref.
Attempting to transmit results in the "HELLO" message appearing and the receive mode being restored.	1 The antenna is not connected correctly.	1 Check the antenna connection. Correct as necessary.	72
	2 The impedances of the antenna and transceiver are not properly matched.	2 Reduce the SWR of the antenna system.	1
	3 The input voltage is outside 13.8 V DC $\pm$ 15% (11.7 to 15.8 V DC).	3 Correct the input voltage or use a 12 to 16 V battery.	2
	4 The current rating of the DC power supply is not enough.	4 Use a DC power supply that has a current rating of more than 20.5 A at 13.8 V DC.	2
The transceiver has low transmit power.	1 The microphone gain is set too low.	1 When in SSB or AM mode, increase the microphone gain.	20
	2 Poor antenna system connections are causing high SWR.	2 Check the antenna connections. Confirm that the antenna tuner is reporting a low SWR.	72
VOX does not operate.	The VOX gain is set too low.	Increase the VOX gain.	39
HF Linear amplifier does not operate.	1 The linear amplifier control relay is OFF.	1 Change Menu No. 28A to ON.	76
	2 The <b>REMOTE</b> connector wiring is wrong or faulty.	2 Inspect the <b>REMOTE</b> connector wiring and correct as necessary.	94
50 MHz, 144 MHz, 430/ 440 MHz or 1.2 GHz linear amplifier does not operate.	1 The linear amplifier control is OFF.	1 Change Menu Nos. 28B ~ 28E to ON.	76
	2 The linear amplifier control cable is connected to the <b>REMOTE</b> connector.	2 Connect the cable to the <b>EXT.CONT</b> connector.	96
	3 The <b>EXT.CONT</b> connector wiring is wrong or faulty.	3 Inspect the <b>EXT.CONT</b> connector wiring and correct as necessary.	96
You cannot access and use repeaters.	1 Many repeaters require a subtone or 1750 Hz tone to access.	1 Review "FM REPEATER OPERATION" and select the correct frequency and type of subtone.	32
	2 Shift direction or shift frequency is wrong.	2 You must transmit on the repeater's input frequency and receive on the repeater's output frequency. Refer to "FM REPEATER OPERATION".	32
Digital operation results in few or no connects or contacts with other stations.	1 Physical connections between the transceiver, computer, and TNC/MCP is incorrect, or software settings in the TNC/MCP are wrong.	1 Re-check all connections using this manual, your TNC/MCP manual, and your computer hardware manual as references.	94,95
	2 Different transmit and receive frequencies are being used.	2 Confirm that the RIT and XIT functions are switched OFF. Confirm that you are NOT operating split frequency.	38,40
	3 The levels between the transceiver and the TNC/MCP are incorrect.	3 Adjust TX and RX levels using Menu Nos. 50B ~ 50D, and level controls on your TNC/MCP.	50
	4 Your transmitted signal or the incoming receive signal is too weak.	4 Reorient/relocate your antenna or increase your antenna gain.	–
	5 The TX delay time parameter in your TNC/MCP was incorrectly set.	5 Set the TNC/MCP TX delay time to more than 300 ms.	–
Attempts at controlling the transceiver with the computer have failed.	1 Problem with the cable that connects the PC to the TS-2000(X)/ TS-B2000.	1 Check the cable and cable connections.	93
	2 Communication parameters set in your terminal program do not match transceiver parameters.	2 Use the same parameters in the terminal program and the transceiver. Check the Menu No. 56.	81



## OPERATION NOTICES

The TS-2000(X)/ TS-B2000 has been designed and engineered to avoid possible hardware glitches. However, you may notice the following symptoms when you operate the transceiver. These symptoms are not malfunctions.

### DC POWER SUPPLY

As stated in the SPECIFICATIONS {page 105}, this transceiver requires a supplied DC voltage source of 13.8 V  $\pm$ 15%. If you find that the transceiver cannot be switched ON, or that it is shut OFF automatically, the DC voltage may be outside the specified range.

In such a case, remove the DC cable from the transceiver immediately and confirm that the supplied voltage is within the specified range.

### TX SIGNAL HARMONICS

The TS-2000(X)/ TS-B2000 has 2 independent receivers. Thus, it can receive signals while you are transmitting. Because of this, the harmonics or the mixed heterodyne signal images of your transmission signal can be monitored through the receiver. Even if the TX Monitor function {page 79} is OFF, the transmission signal may be monitored through the speaker.

### INTERNAL BEATS

On some spots of the transceiver bands, the S-meter moves or you cannot receive any signals. This is inevitable when you use superheterodyne receivers. You may notice the signals on the following spots of the bands.

On the main transceiver:  
51.259 MHz, 430.151 MHz, 432.209 MHz,  
436.799 MHz, 439.298 MHz, 442.440 MHz  
(K-type only), 1247.999 MHz, and 1269.387 MHz.

When the sub-receiver frequency is 144.000 MHz:  
146.663 MHz (K-type only) and 436.249 MHz.

When the sub-receiver frequency is 440.000 MHz:  
437.333 MHz and 444.315 MHz (K-type only).

**Note:** When the sub-receiver frequency changes, the above beat frequencies may be changed accordingly. In this case, turn the sub-receiver OFF to remove the internal spurious signals.

On the sub-receiver:  
144.490 MHz, 144.945 MHz, 430.150 MHz,  
436.210 MHz, 436.800 MHz, 442.020 MHz  
(K-type only), 449.400 MHz (K-type only) and  
429.050 MHz (K-type only).

## VISUAL SCAN

When you have the same VHF band or UHF band for both the main transceiver and the sub-receiver, the Visual scan may indicate the signals on the bar-graph display even if no signal is monitored on the main transceiver. This error occurs due to the internal spurious harmonics that are generated by the sub-receiver. Refer to "INTERNAL BEATS", above, for the frequencies.

### SENSITIVITY (K-type only)

While the main transceiver is receiving on the VHF band (142 ~ 152 MHz), the sensitivity of the main transceiver slightly degrades when you select 118 ~ 136 MHz or 155 ~ 300 MHz for the sub-receiver.

### AGC

When you turn the AGC function OFF {page 38}, the receiving audio signals can be distorted. In this case, decrease the RF GAIN, turn the pre-amplifier OFF, or turn the attenuator ON. In general, the RF GAIN is greatly reduced when the AGC is turned OFF.

### SUB-RECEIVER

When you turn the sub-receiver ON or OFF, a popping noise may be monitored from the speaker.

# OPTIONAL ACCESSORIES

## ARCP-2000

Advanced Radio Control Program



This option is supplied with the TS-B2000.

## DRU-3A

Digital Recording Unit



## HS-5

Deluxe Headphones



## HS-6

Small Headphones



## MB-430

Mobile Mounting Bracket



See page 98 for the installation.

## MC-43S

Hand Microphone



## MC-47

Multi-function Microphone



## MC-60A

Deluxe Desktop Microphone



## MC-90

DSP-compatible Desktop Microphone



Microphone sensitivity is low in FM mode.

## PG-2Z

DC Cable



## PS-60

Regulated DC Power Supply (22.5 A)



## RC-2000

Mobile Controller



## SP-23

External Speaker



## KES-3S

External Speaker



## UT-20

1.2 GHz TX/ RX unit



Service center installation only. Contact an authorized dealer for details.

## VS-3

Voice Synthesizer Unit

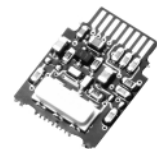

# SPECIFICATIONS

General		TS-2000 TS-B2000	TS-2000X
Mode		J3E (LSB, USB)/ A1A (CW)/ A3E (AM)/ F3E (FM)/ F1D (FSK)/ F2D (F2D)	
Number of memory channels		300	
Antenna impedance		50Ω (with Antenna Tuner 16.7 ~ 150Ω )	
Supply Voltage		DC 13.8 V ±15%	
Grounding method		Negative ground	
Current	Transmit (max.)	20.5 A or less	
	Receive (no signal)	2.6 A or less	
Usable temperature range		-10°C ~ 50°C (+14°F ~ 122°F)	
Frequency stability (-10°C ~ 50°C)	Main	FM TX mode within ±0.5 x 10 <sup>-6</sup> ±2 kHz Other mode within ±0.5 x 10 <sup>-6</sup> (±0.5 ppm)	
	Sub	Within ±0.5 x 10 <sup>-6</sup> ±600 Hz	
Frequency accuracy (at room temperature)		Within ±0.5 ppm	
Dimensions (W x H x D Projections included)		281 x 107 x 371 mm/ 11.06 in x 4.21 in x 14.61 in (TS-2000/ TS-2000X) 281 x 107 x 344.5 mm/ 11.06 in x 4.21 in x 13.56 in (TS-B2000)	
Weight		Approx. 7.8 kg/ 17.2 lb (TS-2000) Approx. 7.5 kg/ 16.6 lb (TS-B2000)	Approx. 8.2 kg/ 18.1 lb

Transmitter		TS-2000 TS-B2000	TS-2000X
Frequency range	160 m band	1.8 ~ 2.0 MHz (K-type) 1.81 ~ 2.0 MHz (E-type) 1.83 ~ 1.85 MHz (E2-type)	
	80 m band	3.5 ~ 4.0 MHz (K-type) 3.5 ~ 3.8 MHz (All E-types)	
	40 m band	7.0 ~ 7.3 MHz (K-type) 7.0 ~ 7.2 MHz (All E-types)	
	30 m band	10.1 ~ 10.15 MHz	
	20 m band	14.0 ~ 14.35 MHz	
	17 m band	18.068 ~ 18.168 MHz	
	15 m band	21.0 ~ 21.45 MHz	
	12 m band	24.89 ~ 24.99 MHz	
	10 m band	28.0 ~ 29.7 MHz	
	6 m band	50.0 ~ 54.0 MHz (K-type) 50.0 ~ 52.0 MHz (E-type) 50.0 ~ 50.2 MHz (E2-type)	
	2 m band	144 ~ 148 MHz (K-type) 144 ~ 146 MHz (All E-types)	
	70 cm band	430 ~ 450 MHz (K-type) 430 ~ 440 MHz (All E-types)	
	23 cm band	1240 ~ 1300 MHz (w/ UT-20)	1240 ~ 1300 MHz

## 20 SPECIFICATIONS

Transmitter			TS-2000 TS-B2000	TS-2000X
Output power	SSB/ CW/ FSK/ FM	Max.	100 W (160 m ~ 2 m band)/ 50 W (70 cm band)/ 10 W (23 cm band)	
		Min.	5 W (160 m ~ 2 m band)/ 5 W (70 cm band)/ 1 W (23 cm band)	
	AM	Max.	25 W (160 m ~ 2 m band)/ 12.5 W (70 cm band)/ 2.5 W (23 cm band)	
		Min.	5 W (160 m ~ 2 m band)/ 5 W (70 cm band)/ 1 W (23 cm band)	
Modulation	SSB		Balanced	
	FM		Reactance	
	AM		Low level	
Spurious emissions	160 m ~ 10 m band		-50 dB or less	
	6 m ~ 70 cm band		-60 dB or less	
	23 cm band		-50 dB or less	
Carrier suppression (SSB)			50 dB or more	
Unwanted sideband suppression (modulation frequency 1.0 kHz)			50 dB or more	
Maximum frequency deviation (FM)	Wide		±5 kHz or less	
	Narrow		±2.5 kHz or less	
XIT shift frequency range			±20.0 kHz	
Microphone impedance			600Ω	

Receiver		TS-2000 TS-B2000	TS-2000X
Circuit type	Main transceiver	SSB/ CW/ AM/ FSK: Quadruple conv. superheterodyne FM: Triple conversion superheterodyne	
	Sub-receiver	FM/ AM: Double conversion superheterodyne	
Frequency range	Main transceiver	0.03 ~ 60.0 MHz (All types) 142 ~ 152 MHz (K-type) 144 ~ 146 MHz (All E-types) 420 ~ 450 MHz (K-type) 430 ~ 440 MHz (All E-types) 1240 ~ 1300 MHz (w/ UT-20)	0.03 ~ 60.0 MHz (All types) 142 ~ 152 MHz (K-type) 144 ~ 146 MHz (E-type) 420 ~ 450 MHz (K-type) 430 ~ 440 MHz (E-type) 1240 ~ 1300 MHz (All types)
	Sub-receiver	118 ~ 174 MHz (K-type) 144 ~ 146 MHz (All E-types) 220 ~ 512 MHz (K-type) 430 ~ 440 MHz (All E-types)	118 ~ 174 MHz (K-type) 144 ~ 146 MHz (E-type) 220 ~ 512 MHz (K-type) 430 ~ 440 MHz (E-type)
Intermediate Frequency (IF)	Main transceiver	1st IF 0.03 ~ 60 MHz: 69.085 MHz or 75.925 MHz 118 ~ 512 MHz: 41.895 MHz 1240 ~ 1300 MHz: 135.495 MHz 2nd IF: 10.695 MHz 3rd IF: 455 kHz 4th IF: 12.0 kHz	
	Sub-receiver	1st IF: 58.525 MHz 2nd IF: 455 kHz	

Receiver		TS-2000 TS-B2000	TS-2000X	
Sensitivity	SSB/ CW/ FSK (S/N 10 dB)	Main	0.5 ~ 1.705 MHz: 4 μV or less 1.705 ~ 24.5 MHz: 0.2 μV or less 24.5 ~ 30.0 MHz: 0.13 μV or less 50.0 ~ 54.0 MHz: 0.13 μV or less 144 ~ 146 MHz: 0.11 μV or less (All E-types) 144 ~ 148 MHz: 0.16 μV or less (K-type) 430 ~ 440 MHz: 0.11 μV or less (All E-types) 430 ~ 450 MHz: 0.11 μV or less (K-type) 1240 ~ 1300 MHz: 0.11 μV or less (All types)	
	AM (S/N 10 dB)		0.5 ~ 1.705 MHz: 31.6 μV or less 1.705 ~ 24.5 MHz: 2.0 μV or less 24.5 ~ 30.0 MHz: 1.3 μV or less 50.0 ~ 54.0 MHz: 1.3 μV or less 144 ~ 146 MHz: 1.0 μV or less (All E-types) 144 ~ 148 MHz: 1.4 μV or less (K-type) 430 ~ 440 MHz: 1.0 μV or less (All E-types) 430 ~ 450 MHz: 1.0 μV or less (K-type) 1240 ~ 1300 MHz: 1.0 μV or less (All types)	
	FM (12 dB SINAD)		28.0 ~ 30.0 MHz: 0.22 μV or less 50.0 ~ 54.0 MHz: 0.22 μV or less 144 ~ 146 MHz: 0.18 μV or less (All E-types) 144 ~ 148 MHz: 0.25 μV or less (K-type) 430 ~ 440 MHz: 0.18 μV or less (All E-types) 430 ~ 450 MHz: 0.18 μV or less (K-type) 1240 ~ 1300 MHz: 0.18 μV or less (All types)	
	AM (S/N 10 dB)		Sub	144 ~ 146 MHz: 1.55 μV or less (All E-types) 144 ~ 148 MHz: 2.25 μV or less (K-type) 430 ~ 440 MHz: 1.55 μV or less (All E-types) 438 ~ 450 MHz: 1.55 μV or less (K-type)
	FM (12 dB SINAD)			144 ~ 146 MHz: 0.28 μV or less (All E-types) 144 ~ 148 MHz: 0.40 μV or less (K-type) 430 ~ 440 MHz: 0.28 μV or less (All E-types) 438 ~ 450 MHz: 0.28 μV or less (K-type)
	Selectivity		SSB (Low-cut: 300 Hz/ Hi-cut: 2600 Hz)	Main
AM (Low-cut: 100 Hz/ Hi-cut: 3000 Hz)		-6 dB: 6.0 kHz, -50 dB: 12.0 kHz		
FM		-6 dB: 12.0 kHz, -50 dB: 25.0 kHz		
AM		Sub	-6 dB: 12.0 kHz, -50 dB: 25.0 kHz	
FM			-6 dB: 12.0 kHz, -50 dB: 25.0 kHz	
Image rejection	Main transceiver	70 dB or more		
	Sub-receiver	60 dB or more		
1st IF rejection	Main transceiver	70 dB or more		
	Sub-receiver	60 dB or more		
Notch filter attenuation (at 1 kHz)		30 dB or more		
Beat cancel attenuation (at 1 kHz)		40 dB or more		
RIT shift frequency range		±20.0 kHz		

## 20 SPECIFICATIONS

Receiver			TS-2000 TS-B2000	TS-2000X
Squelch sensitivity	SSB/ CW/ FSK/ AM	Main	0.5 ~ 1.705 MHz: 18.0 $\mu$ V or less 1.8 ~ 28.7 MHz: 1.8 $\mu$ V or less 50.0 ~ 54.0 MHz: 1.1 $\mu$ V or less 144 ~ 146 MHz: 1.1 $\mu$ V or less (All E-types) 144 ~ 148 MHz: 1.1 $\mu$ V or less (K-type) 430 ~ 440 MHz: 1.1 $\mu$ V or less (All E-types) 430 ~ 450 MHz: 1.1 $\mu$ V or less (K-type) 1240 ~ 1300 MHz: 1.1 $\mu$ V or less (All types)	
			28.0 ~ 30.0 MHz: 0.2 $\mu$ V or less 50.0 ~ 54.0 MHz: 0.2 $\mu$ V or less 144 ~ 146 MHz: 0.1 $\mu$ V or less (All E-types) 144 ~ 148 MHz: 0.16 $\mu$ V or less (K-type) 430 ~ 440 MHz: 0.1 $\mu$ V or less (All E-types) 430 ~ 450 MHz: 0.1 $\mu$ V or less (K-type) 1240 ~ 1300 MHz: 0.1 $\mu$ V or less (All types)	
	AM	Sub	144 ~ 146 MHz: 1.1 $\mu$ V or less (All E-types) 144 ~ 148 MHz: 1.1 $\mu$ V or less (K-type) 430 ~ 440 MHz: 1.1 $\mu$ V or less (All E-types) 438 ~ 450 MHz: 1.1 $\mu$ V or less (K-type)	
	FM		144 ~ 146 MHz: 0.18 $\mu$ V or less (All E-types) 144 ~ 148 MHz: 0.23 $\mu$ V or less (K-type) 430 ~ 440 MHz: 0.18 $\mu$ V or less (All E-types) 438 ~ 450 MHz: 0.18 $\mu$ V or less (K-type)	
Audio output (8 $\Omega$ , 10% distortion)			1.5 W or more	
Audio output impedance (EXT.SP1 and EXT.SP2)			8 $\Omega$	

## TS-B2000 FRONT PANEL

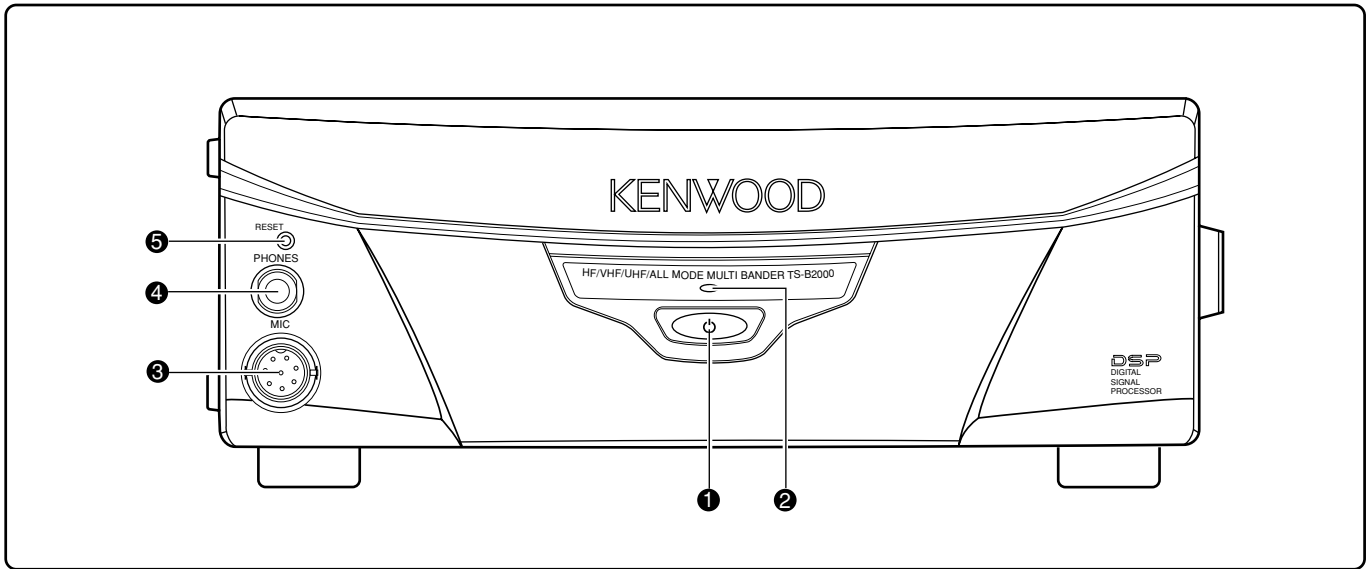

### ❶ [ ⏻ ] (POWER) switch

Press and hold briefly to switch the transceiver power ON. Press again to switch the power OFF.

### ❷ Power indicator

While the transceiver is turned ON, it lights red.

### ❸ MIC connector

Connect a compatible microphone to this connector, then securely screw down the connector locking ring {page 3}.

### ❹ PHONES jack

Connect a set of headphones to this jack. Inserting a plug into the jack automatically mutes the audio from the speaker {page 3}.

### ❺ RESET button

Push this switch to reset the microprocessor in the transceiver. This sets all the contents of the memory function to the factory default values.

## 21 APPENDIX

### BUILT-IN TNC COMMAND LIST

All descriptions in this section are for the users convenience only. **KENWOOD** will not support or warrantee this documentation in any way. The built-in TNC does not support the digipeater functions due to the RAM capacity.

Command Name	Short	Default	Parameter	Description
AUTOLF	AU	ON	ON/ OFF	When ON, sends a line feed (LF) to the computer after each carriage return (CR).
AWLEN	AW	8	7/ 8	Sets the length of bits between TNC and its host.
BEACON	B	EVERY 0	EVERY/ AFTER n (n = 0 ~ 250)	If set to EVERY, sends a beacon packet at intervals of the specified period (n). If set to AFTER, sends a beacon packet only once after the specified period (n). The unit of n is 10 seconds.
BTEXT	BT	—	0 ~ 159 characters	Specifies the content of the data portion of a beacon packet.
CALIBRA	CAL	—	—	Sends a space/mark square wave (50/50 ratio). Enter Q to exit Calibrate mode and restore the Command mode.
CHECK	CH	30	0 ~ 250	Specifies the interval from signal drop-out until execution of disconnection. The unit of the parameter is 10 seconds.
CONNECT	C	—	Call1 (VIA call2, call3, ... call9)	Sends a connect request. Call1 is the call sign of the station to be connected to. Call2 to call9 are call signs of stations to be digipeated through.
CONVERSE	CONV or K	—	—	Causes the TNC to enter Converse mode. Press <b>[Ctrl]+[C]</b> to restore the Command mode.
CPACTIME	CP	OFF	ON/ OFF	When ON and in Converse mode, sends a packet at intervals of the period determined by PACTIME.
CR	CR	ON	ON/ OFF	When ON, appends a carriage return (CR) to all packets to be sent.
DISCONNE	D	—	—	Sends a disconnect request.
DISPLAY	DISP	—	—	Causes the TNC to display the current status of all the commands. You can also specify a class identifier A, C, H, I, L, M, or T to display the status of only the desired command class. Enter a space between the command name and a class identifier; ex. DISPLAY H. A (ASYNC): RS-232C port parameters C (CHAR): Special TNC characters H (HEALTH): Counter parameters I (ID): ID parameters L (LINK): TNC-to-TNC link status M (MONITOR): Monitor parameters T (TIMING): Timing parameters
DWAIT	DW	30	0 ~ 250	Specifies the interval from no carrier detection until execution of transmission. The unit of the parameter is 10 milliseconds.
ECHO	E	ON	ON/ OFF	When ON, causes the TNC to echo received characters to the computer.
FIRMRNR	FIR	OFF	ON/ OFF	The other station sends a notice (packet) to you if it is not ready to receive data. When ON, receiving such a notice causes the TNC to suspend transmission until it receives a "ready" notice.



Command Name	Short	Default	Parameter	Description
FLOW	F	ON	ON/ OFF	When ON, starting key entry causes the computer to stop displaying received packets.
FRACK	FR	3	0 ~ 250	Specifies the interval from one transmission until retry of transmission. The unit of the parameter is 1 second.
HBAUD	HB	1200	1200/ 9600	Selects 1200 or 9600 bps as the transfer rate between packet stations.
MCOM	MCOM	OFF	ON/ OFF	When ON, causes the TNC to also monitor control packets. When OFF, causes it to monitor only information packets.
MCON	MC	OFF	ON/ OFF	When ON, causes the TNC to monitor other stations while in connection with the target station.
MONITOR	M	ON	ON/ OFF	When ON, causes the TNC to monitor packets.
MRPT	MR	ON	ON/ OFF	When ON, causes the TNC to display the entire digipeat list for monitored packets.
MYCALL	MY	NOCALL	6 characters + SSID	Specifies your call sign.
PACLEN	P	128	0 ~ 255	Specifies the maximum length of the data portion of a packet.
PACTIME	PACT	AFTER 10	EVERY/ AFTER n (n = 0 ~ 250)	If set to EVERY, sends a packet at intervals of the specified period (n). If set to AFTER, sends a packet only once after the specified period (n). The unit of n is 100 milliseconds.
PERSIST	PE	128	0 ~ 255	Specifies a parameter to calculate probability for the PERSIST/SLOTTIME method.
PPERSIST	PP	ON	ON/ OFF	Causes the TNC to use the PERSIST/SLOTTIME method when ON, or the DWAIT method when OFF.
RESET	RESET	—	—	Restores the default status for all the commands.
RESPTIME	RES	5	0 ~ 250	Specifies the acknowledgment packet transmission delay. The unit of the parameter is 100 milliseconds.
RESTART	RESTART	—	—	Causes the TNC to function as if it is switched OFF then ON.
RETRY	RE	10	0 ~ 15	Specifies the number of transmission retries. If packets are not correctly accepted while in connection, a connect request is sent again after the specified number of retries.
SENDPAC	SE	\$0D	0 ~ \$7F	Specifies a character which forces a packet to be sent.
SLOTTIME	SL	3	0 ~ 250	Specifies the period of random number generation intervals for the PERSIST/SLOTTIME method. The unit of the parameter is 10 milliseconds.
TRACE	TRAC	OFF	ON/ OFF	When ON, causes the TNC to display all received packets in their entirety.

## 21 APPENDIX

Command Name	Short	Default	Parameter	Description
TRIES	TRI	0	0 ~ 15	Specifies the number of transmission retries programmed in the retry counter.
TXDELAY	TX	50	0 ~ 120	Specifies the time delay between PTT ON and the start of transmission. The unit of the parameter is 10 milliseconds.
UNPROTO	U	CQ	Call1 (VIA call2, call3, ... call9)	Specifies call signs to send a packet in Unprotocol mode. Call1 is the call sign of the destination. Call2 to call9 are call signs of stations to be digipeated through.
XFLOW	X	ON	ON/ OFF	Causes the TNC to perform software flow control when ON, or hardware flow control when OFF.

**Note:**

- ◆ *If you are using a PC with a communication program to control the built-in TNC, prepare the RS-232C cable (straight) to connect with the COM terminal of the transceiver. Then, access Menu No. 56 and select the same communication speed and communications parameters. Other than 4800 bps, the parameters must be set to 8-bit, 1-stop bit, and non-parity. 4800 bps is also used for the Quick Data Transfer function (page 80) and the communication parameters are fixed as 8-bit, 2-stop bit, and non-parity.*
- ◆ *To use the above commands, you must operate the transceiver in Packet communication mode. The default operation mode is PC Control Command mode (page 113). To switch to Packet communication mode, either set Menu No. 55 to "ON" (pages 25, 49) or key in "TC 0" (page 138).*

## COM CONNECTOR

All descriptions in the PC CONTROL COMMAND TABLE are for the users convenience only.

**KENWOOD** will not support or warrantee this documentation in any way.

### HARDWARE DESCRIPTION

This transceiver uses a full-duplex, asynchronous, serial interface for communicating through the male 9-PIN RS-232C **COM** connector. Each data is constructed with 1 start bit, 8 data bits, and 1 stop bit (4800 bps must be configured as 2 stop bits). No parity is used. The pinout and the pin functions of the **COM** connector are shown below:

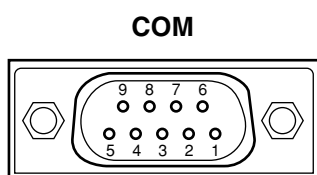

Rear panel view

COM Pin No.	COM Pin Name (Ref.: Computer)	Function (Ref.: Transceiver)	I/O
1	NC	—	—
2	$\overline{\text{RXD}}$	Transmit data	Output
3	$\overline{\text{TXD}}$	Receive data	Input
4	NC	—	—
5	GND	Signal ground	
6	NC	—	—
7	RTS	Receive enable	Input
8	CTS	Transmit enable	Output
9	NC	—	—

**$\overline{\text{RXD}}$** : Transmit data is serial data transferred from the transceiver to the computer.

**$\overline{\text{TXD}}$** : Receive data is serial data transferred from the computer to the transceiver.

**GND**: Signal ground pin

**RTS**: This signal is applied to the transceiver. It is used to inhibit transmit data from the transceiver when the computer is not ready to receive data. Transmit data is inhibited when the level is low.

**CTS**: This signal is applied from the transceiver. It is used to inhibit transmit data from the computer when the transceiver is not ready to receive data. Transmit data is stopped when the level is low.

## CONTROL OPERATION

Most computers handle data in the form of “bits” and “bytes”. A bit is the smallest piece of information that a computer can handle. A byte is composed of eight bits. This is the most convenient form for most computer data. This data may be sent in the form of either serial or parallel data strings. The parallel method is faster but more complicated, while the serial method is slower and requires less complicated equipment. The serial form is, therefore, a less expensive alternative.

Serial data transmission uses time-division methods over a single line. Using a single line also offers the advantage of reducing the number of errors due to line noise.

Only 3 lines are required theoretically for control of the transceiver via the computer:

- Transmit data
- Receive data
- Ground

From a practical standpoint, it is also necessary to incorporate some means of controlling when this data transfer will occur. The computer and transceiver cannot be allowed to send data at the same time! The required control is achieved by using the RTS and CTS lines.

For example, the transceiver is placed into the transmit mode whenever the character string “TX;” is sent from the computer. The character string “TX;” is called a computer control command. It tells the transceiver what to do. There are numerous commands available for control of the transceiver. These commands may be incorporated into a computer program written in any high level language. Programming methods vary from computer to computer; therefore, refer to the instruction manuals provided with the terminal program and computer.

**COMPUTER CONTROL COMMANDS**

A computer control command is composed of an alphabetical command, various parameters, and the terminator that signals the end of the control command.

EXAMPLE: Command to set VFO A to 7 MHz

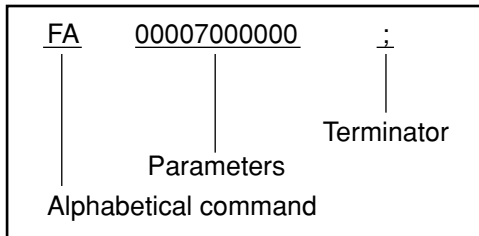

Commands can be classified as shown below:

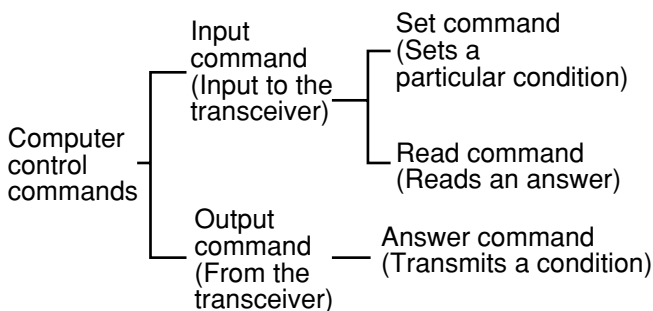

For example, note the following in the case of the FA command (Frequency of VFO A):

- To set the frequency to 7 MHz, the following command is sent from the computer to the transceiver:  
 "FA00007000000;" **(Set command)**
- To read the frequency of VFO A, the following command is sent from the computer to the transceiver:  
 "FA;" **(Read command)**
- When the Read command above has been sent, the following command is returned to the computer:  
 "FA00007000000;" **(Answer command)**

**Note:**

- Do not use the control characters 00 to 1Fh since they are either ignored or cause a "?" answer.
- Program execution may be delayed while turning the Tuning control rapidly.
- Receive data is not processed if the frequency is entered from the keypad.

■ **Alphabetical Commands**

A command consists of 2 alphabetical characters. You may use either lower or upper case characters. The commands available for this transceiver are listed in the PC Control Command Tables {page 115}.

■ **Parameters**

Parameters are used to specify information necessary to implement the desired command. The parameters to be used for each command are predetermined. The number of digits assigned to each parameter is also predetermined. Refer to the Computer Control Commands and the PC Control Command Tables {page 115} to configure the appropriate parameters.

When configuring parameters, be careful not to make the following mistakes.

(correct parameter: "IS+1000")

- IS1000; Not enough parameters specified (No direction given for the IF shift)
- IS+100; Not enough digits (Only three frequency digits given)
- IS □ + □ 1000; Unnecessary characters between parameters
- IS+10000; Too many digits (Five frequency digits given)

*Note: If a particular parameter is not applicable to this transceiver, the parameter digits should be filled using any character except the ASCII control codes (00 to 1Fh) and the terminator (;).*

■ **Terminator**

To signal the end of a command, it is necessary to use a semicolon (;). The digit where this special character must appear differs depending on the command used.

■ **Error Messages**

In addition to the Answer command, the transceiver can send the following error messages.

Error Message	Reason for Error
?	<ul style="list-style-type: none"> <li>Command syntax was incorrect.</li> <li>Command was not executed due to the current status of the transceiver (even though the command syntax was correct).</li> </ul> <p><i>Note: Occasionally this message may not appear due to microprocessor transients in the transceiver.</i></p>
E;	A communication error occurred such as an overrun or framing error during a serial data transmission.
O;	Receive data was sent but processing was not completed.

## PC CONTROL COMMAND TABLES

<b>AC</b>	Sets or reads the internal antenna tuner status.										Parameters:
Set	1	2	3	4	5	6	7	8	9	10	P1 0: RX-AT THRU 1: RX-AT IN
	A	C	P1	P2	P3	;					
Read	1	2	3	4	5	6	7	8	9	10	P2 0: TX-AT THRU 1: TX-AT IN
	A	C	;								
Answer	1	2	3	4	5	6	7	8	9	10	P3 0: Stop tuning (Set)/ Tuning is stopped (Answer) 1: Start Tuning (Set)/ Tuning is active (Answer) 2: Tuning cannot be completed
	A	C	P1	P2	P3	;					

<b>AG</b>	Sets or reads the AF gain.										Parameters:
Set	1	2	3	4	5	6	7	8	9	10	P1 0: Main transceiver 1: Sub-receiver
	A	G	P1	P2	P2	P2	;				
Read	1	2	3	4	5	6	7	8	9	10	P2 000 (min.) ~ 255 (max.)
	A	G	P1	;							
Answer	1	2	3	4	5	6	7	8	9	10	
	A	G	P1	P2	P2	P2	;				

<b>AI</b>	Sets or reads the Auto Information (AI) function ON/ OFF.										Parameters:
Set	1	2	3	4	5	6	7	8	9	10	P1 0: AI OFF 2: Extended AI format is ON
	A	I	P1	;							
Read	1	2	3	4	5	6	7	8	9	10	When the extended AI format is selected, the transceiver automatically sends the parameters.
	A	I	;								
Answer	1	2	3	4	5	6	7	8	9	10	Note: "AI1;" and "AI3;" (old AI commands) are not supported in the TS-2000/ TS-B2000. There may be incompatibilities between the transceiver and your PC logging software; changes may not be reflected when using these commands.
	A	I	P1	;							

<b>AL</b>	Sets or reads the Auto Notch level.										Parameters:
Set	1	2	3	4	5	6	7	8	9	10	P1 000 ~ 004
	A	L	P1	P1	P1	;					
Read	1	2	3	4	5	6	7	8	9	10	
	A	L	;								
Answer	1	2	3	4	5	6	7	8	9	10	
	A	L	P1	P1	P1	;					

<b>AM</b>	Sets or reads the Auto Mode ON/ OFF.										Parameters:
Set	1	2	3	4	5	6	7	8	9	10	P1 0: Auto Mode function is OFF 1: Auto Mode function is ON
	A	M	P1	;							
Read	1	2	3	4	5	6	7	8	9	10	
	A	M	;								
Answer	1	2	3	4	5	6	7	8	9	10	
	A	M	P1	;							

## 21 APPENDIX

<b>AN</b>	Selects the antenna connector ANT1/ ANT2.										Parameters:
Set	1	2	3	4	5	6	7	8	9	10	P1 0: Reads the current antenna selection 1: Selects ANT1 2: Selects ANT2
	A	N	P1	;							
Read	1	2	3	4	5	6	7	8	9	10	
	A	N	;								
Answer	1	2	3	4	5	6	7	8	9	10	
	A	N	P1	;							

<b>AR</b>	Sets or reads the ASC function ON/ OFF. Reports the status of the ASC function.										Parameters:
Set	1	2	3	4	5	6	7	8	9	10	P1 0: Main transceiver 1: Sub-receiver P2 0: ASC OFF 1: ASC ON P3 0: Simplex contact is possible 1: Simplex contact is not possible P2 parameter is valid only to "CTRL" band. When ASC function is OFF, the response is unknown.
	A	R	P1	P2	P3	;					
Read	1	2	3	4	5	6	7	8	9	10	
	A	R	P1	;							
Answer	1	2	3	4	5	6	7	8	9	10	
	A	R	P1	P2	P3	;					

<b>AS</b>	Sets or reads the Auto Mode function parameters.										Parameters:
Set	1	2	3	4	5	6	7	8	9	10	P1 0: HF ~ 50 MHz band 1: 144 MHz band 2: 430/ 440 MHz band 3: 1.2 GHz band P2 00 ~ 99 00 ~ 28: HF ~ 50 MHz band (28 points) 00 ~ 08: 144 MHz, 430/ 440 MHz, 1.2 GHz band (8 points for each band) P3 Frequency in Hz (11-digit) P4 0: Reserved 1: LSB 2: USB 3: CW 4: FM 5: AM 6: FSK 7: CW-R 8: Reserved 9: FSK-R
	A	S	P1	P2	P2	P3	P3	P3	P3	P3	
	11	12	13	14	15	16	17	18	19	20	
P3	P3	P3	P3	P3	P3	P4	;				
Read	1	2	3	4	5	6	7	8	9	10	
	A	S	P1	P2	P2	;					
Answer	1	2	3	4	5	6	7	8	9	10	
	A	S	P1	P2	P2	P3	P3	P3	P3	P3	
	11	12	13	14	15	16	17	18	19	20	
P3	P3	P3	P3	P3	P3	P4	;				

<b>BC</b>	Sets or reads the Beat Canceller function status.										Parameters:
Set	1	2	3	4	5	6	7	8	9	10	P1 0: Beat Canceller OFF 1: Auto Beat Canceller ON 2: Manual Beat Canceller ON
	B	C	P1	;							
Read	1	2	3	4	5	6	7	8	9	10	
	B	C	;								
Answer	1	2	3	4	5	6	7	8	9	10	
	B	C	P1	;							

<b>BD</b>	Moves down the frequency band.										Parameters:
Set	1	2	3	4	5	6	7	8	9	10	None
	B	D	;								
Read	1	2	3	4	5	6	7	8	9	10	
Answer	1	2	3	4	5	6	7	8	9	10	

<b>BP</b>	Sets or reads the Manual Beat Canceller frequency settings.										Parameters: P1 000 ~ 063	
	Set	1	2	3	4	5	6	7	8	9		10
		B	P	P1	P1	P1	;					
	Read	1	2	3	4	5	6	7	8	9		10
B		P	;									
Answer	1	2	3	4	5	6	7	8	9	10		
	B	P	P1	P1	P1	;						

<b>BU</b>	Moves up the frequency band.										Parameters: None	
	Set	1	2	3	4	5	6	7	8	9		10
		B	U	;								
	Read	1	2	3	4	5	6	7	8	9		10
Answer	1	2	3	4	5	6	7	8	9	10		

<b>BY</b>	Reads the busy signal status.										Parameters: P1 Main transceiver 0: Not busy 1: Busy P2 Sub-receiver 0: Not Busy 1: Busy  When the Sky Command function is ON, only the P1 parameter is used.	
	Set	1	2	3	4	5	6	7	8	9		10
	Read	1	2	3	4	5	6	7	8	9		10
B		Y	;									
Answer	1	2	3	4	5	6	7	8	9	10		
	B	Y	P1	P2	;							

<b>CA</b>	Sets and reads the CW AUTO TUNE function status.										Parameters: P1 0: Cancels CW AUTO TUNING function/ Not active 1: Activates CW AUTO TUNING function/ Active	
	Set	1	2	3	4	5	6	7	8	9		10
		C	A	P1	;							
	Read	1	2	3	4	5	6	7	8	9		10
C		A	;									
Answer	1	2	3	4	5	6	7	8	9	10		
	C	A	P1	;								

<b>CG</b>	Sets and reads the CARRIER GAIN status.										Parameters: P1 000 (min.) ~ 100 (max.)	
	Set	1	2	3	4	5	6	7	8	9		10
		C	G	P1	P1	P1	;					
	Read	1	2	3	4	5	6	7	8	9		10
C		G	;									
Answer	1	2	3	4	5	6	7	8	9	10		
	C	G	P1	P1	P1	;						

## 21 APPENDIX

<b>CH</b>	Sets the current frequency to the CALL channel.										Parameters: P1 0: Move the MULTI/ CH control 1 step up 1: Move the MULTI/ CH control 1 step down									
Set	1	2	3	4	5	6	7	8	9	10	C	H	P1	;						
Read	1	2	3	4	5	6	7	8	9	10										
Answer	1	2	3	4	5	6	7	8	9	10										

<b>CI</b>	Sets the current frequency to the CALL channel.										Parameters: None									
Set	1	2	3	4	5	6	7	8	9	10	C	I	;							
Read	1	2	3	4	5	6	7	8	9	10										
Answer	1	2	3	4	5	6	7	8	9	10										

While in VFO mode or Memory recall mode, it sets the frequency to the CALL channel.

<b>CM</b>	Sets or reads the PACKET CLUSTER TUNE function ON/OFF.										Parameters: P1 0: Packet Cluster Tune function OFF 1: Packet Cluster Tune function ON									
Set	1	2	3	4	5	6	7	8	9	10	C	M	P1	;						
Read	1	2	3	4	5	6	7	8	9	10	C	M	;							
Answer	1	2	3	4	5	6	7	8	9	10	C	M	P1	;						

<b>CN</b>	Sets and reads the CTCSS function.										Parameters: P1 01 ~ 38									
Set	1	2	3	4	5	6	7	8	9	10	C	N	P1	P1	;					
Read	1	2	3	4	5	6	7	8	9	10	C	N	;							
Answer	1	2	3	4	5	6	7	8	9	10	C	N	P1	P1	;					

Refer to page 35 for the CTCSS tone numbers.

<b>CT</b>	Sets and reads the CTCSS function status.										Parameters: P1 0: CTCSS function OFF 1: CTCSS function ON									
Set	1	2	3	4	5	6	7	8	9	10	C	T	P1	;						
Read	1	2	3	4	5	6	7	8	9	10	C	T	;							
Answer	1	2	3	4	5	6	7	8	9	10	C	T	P1	;						



<b>DC</b>	Sets and reads the TX band status.										Parameters:										
Set	1	2	3	4	5	6	7	8	9	10	D	C	P1	P2	;						P1 0: Sets TX band to the main transceiver 1: Sets TX band to the sub-receiver ON P2 0: Sets CONTROL band to the main transceiver 1: Sets CONTROL band to the sub-receiver When the P1 parameter changes, the same parameter is set to P2.
	Read	1	2	3	4	5	6	7	8	9											
Answer	1	2	3	4	5	6	7	8	9	10	D	C	P1	P2	;						

<b>DN</b>	Emulates the microphone DWN key.										Parameters:										
Set	1	2	3	4	5	6	7	8	9	10	D	N	P1	P1	;						P1 00 ~ 99 If no P1 parameter is specified, the command is interpreted as 1 step down. In Memory mode and Quick Memory mode, the command without a parameter is treated as a Memory channel down command. With parameters, it is treated as the frequency down command.
	Read	1	2	3	4	5	6	7	8	9											
Answer	1	2	3	4	5	6	7	8	9	10											

<b>DQ</b>	Sets and reads the DCS function status.										Parameters:										
Set	1	2	3	4	5	6	7	8	9	10	D	Q	P1	;							P1 0: DCS function OFF 1: DCS function ON
	Read	1	2	3	4	5	6	7	8	9											
Answer	1	2	3	4	5	6	7	8	9	10	D	Q	P1	;							

<b>EX</b>	Sets or reads the Extension Menu.										Parameters:																				
Set	1	2	3	4	5	6	7	8	9	10	E	X	P1	P1	P1	P2	P2	P3	P4	P5	P1 000 ~ 999: Menu No. (1st) P2 00 ~ 99: Menu No. (2nd) P3 0 ~ 9: Menu No. (3rd) P4 0 ~ 9: Menu No. (4th) P5 A string of characters (Variable length) If the 2nd and 3rd menus are not available, set "00". Specify 1 digit only. Display brightness: EX00000000; (Dimmer OFF). EX00000003; (Dimmer level 2). Menu 29B, 31, 33, 51A ~ E, 59 and 62C have 2-digit parameters. Menu 61C (P5): 000 ~ 999 (3-digit). Menu 62A ~ B (P5): A maximum of 8 characters. Menu 45A (P3): 0 ~ 9 for DTMF Memory channel number. Menu 45A (P4): 0 (DTMF), 1 (Code) Menu 45A (P5): A maximum of 16 digits. If the first character is a space character, the name will be cleared. 62A and 62B become "NO CALL". Although you can turn Menu No. 55 ON, using the EX command, you must use the TC 1; command to turn it OFF.										
	11	12	13	14	15	16	17	18	19	20												P5	P5	P5	P5	P5	P5	P5	P5	P5	
	21	22	23	24	25	26	27	28	29	30												P5	P5	P5	P5	P5	;				
	1	2	3	4	5	6	7	8	9	10												E	X	P1	P1	P1	P2	P2	P3	P4	;
	11	12	13	14	15	16	17	18	19	20												E	X	P1	P1	P1	P2	P2	P3	P4	P5
	21	22	23	24	25	26	27	28	29	30												P5	P5	P5	P5	P5	P5	P5	P5	P5	P5
Answer	1	2	3	4	5	6	7	8	9	10	E	X	P1	P1	P1	P2	P2	P3	P4	P5											
	11	12	13	14	15	16	17	18	19	20												P5	P5	P5	P5	P5	P5	P5	P5	P5	
Answer	21	22	23	24	25	26	27	28	29	30	P5	P5	P5	P5	P5	;															

## 21 APPENDIX

Menu No.	Function	EX command parameter P5										
		0	1	2	3	4	5	6	7	8	9	Over
00	Display brightness	OFF	1	2	3	4						
01	Key illumination	OFF	ON									
02	Tuning control change per revolution	500	1000									
03	Tuning with the <b>MULTI/ CH</b> control	OFF	ON									
04	Rounds off VFO frequencies changed by using the <b>MULTI/ CH</b> control	OFF	ON									
05	9 kHz frequency step size for the <b>MULTI/ CH</b> control in AM mode on the AM broadcast band	OFF	ON									
06A	Memory-VFO split operation	OFF	ON									
06B	Tunable (ON) or fixed (OFF) memory channel frequencies	OFF	ON									
07	Program scan partially slowed	OFF	ON									
08	Slow down frequency range for the Program scan	100	200	300	400	500						
09	Program scan hold	OFF	ON									
10	Scan resume method	TO	CO									
11	Visual scan range	31	61	91	181							
12	Beep output level	OFF	1	2	3	4	5	6	7	8	9	
13	TX sidetone volume	OFF	1	2	3	4	5	6	7	8	9	
14	DRU-3A playback volume	OFF	1	2	3	4	5	6	7	8	9	
15	VS-3 playback volume	OFF	1	2	3	4	5	6	7	8	9	
16	Audio output configuration for EXT.SP2 or headphone	0	1	2								
17	Reverses the EXT.SP1 and EXT.SP2 (the headphone jack L/R channels) audio outputs	OFF	ON									
18	Enable an input from the HF RX ANT connector	OFF	ON									
19A	S-meter squelch	OFF	ON									
19B	Hang time for S-meter squelch	OFF	125	250	500							
20	DSP RX equalizer	OFF	H BOOST	F PASS	B BOOST	CONV-EN	USER					
21	DSP TX equalizer	OFF	H BOOST	F PASS	B BOOST	CONV-EN	USER					
22	DSP TX filter bandwidth for SSB or AM	2.0	2.2	2.4	2.6	2.8	3.0					
23	Fine transmit power tuning	OFF	ON									
24	Time-out Timer	OFF	3	5	10	20	30					
25	Transverter frequency display	OFF	ON									
26	TX hold when AT completes the tuning	OFF	ON									
27	In-line AT while receiving	OFF	O1N									
28A	Linear amplifier control delay for HF band	OFF	1	2								
28B	Linear amplifier control delay for 50 MHz band	OFF	1	2								
28C	Linear amplifier control delay for 144 MHz band	OFF	1	2								
28D	Linear amplifier control delay for 430/ 440 MHz band	OFF	1	2								
28E	Linear amplifier control delay for 1.2 GHz band	OFF	1	2								
29A	Repeat the playback	OFF	ON									
29B	Interval time for repeating the playback	0	1	2	3	4	5	6	7	8	9	~ 60 (in steps of 1)
30	Keying priority over playback	OFF	ON									

Menu No.	Function	EX command parameter P5										
		0	1	2	3	4	5	6	7	8	9	Over
31	CW RX pitch/ TX sidetone frequency	400	450	500	550	600	650	700	750	800	850	~ 1000 (in steps of 50)
32	CW rise time	1	2	4	6							
33	CW keying dot, dash weight ratio	AUTO	2.5	2.6	2.7	2.8	2.9	3.0	3.1	3.2	3.3	~ 4.0 (in steps of 0.1)
34	Reverse CW keying auto weight ratio	OFF	ON									
35	Bug key mode	OFF	ON									
36	Auto CW TX in SSB mode	OFF	ON									
37	Frequency correction for changing SSB to CW	OFF	ON									
38	FSK shift	170	200	425	850							
39	FSK keying polarity	NOR- MAL	INVE- RS									
40	FSK tone frequency	1275	2125									
41	Mic gain for FM	LOW	MID	HIGH								
42	Sub-tone mode for FM	BURST	CONT									
43	Auto repeater offset	OFF	ON									
44	TX hold: 1750 Hz tone	OFF	ON									
45A	DTMF number memory select	See the parameter comments.										
45B	TX speed for stored DTMF number	SLOW	FAST									
45C	Pause duration for stored DTMF number	100	250									
45D	Enable Mic remote control	OFF	ON									
46	MAIN/ SUB band: Internal TNC	MAIN	SUB									
47	Data transfer speed: Internal TNC	1200	9600									
48	DCD sensing band	TNC BAND	MAIN- &SUB									
49A	Packet Cluster Tune mode	AUTO	MAN- UAL									
49B	Packet Cluster RX confirmation tone	OFF	MOR- SE	VOICE								
50A	Packet filter bandwidth	OFF	ON									
50B	AF input level for Packet	0	1									
50C	MAIN band AF output level for packet operation	0	1									
50D	SUB band AF output level for packet operation	0	1									
50E	MAIN/ SUB band: External TNC	MAIN	SUB									
50F	Data transfer speed: External TNC	1200	9600									
51A	Front panel PF key	00 ~ 99 (2-digit) 0 ~ 62: Menu No., 63: VOICE1, 64: VOICE2, 65: RX MONI, 66: DSP MONI, 67: QUICK MEMO MR, 68: QUICK MEMO M.IN, 69: SPLIT, 70: TF-SET, 71: A/B, 72: VFO/M, 73: A=B, 74: SCAN, 75: M>VFO, 76: M.IN, 77: CW TUNE, 78: CH1, 79: CH2, 80: CH3, 81: FINE, 82: CLR, 83: CALL, 84: CTRL, 85: 1MHz, 86: ANT1/2, 87: NB, 88: N.R., 89: B.C., 90: A. N., 99: No function										
51B	Microphone PF1 key											
51C	Microphone PF2 key											
51D	Microphone PF3 key											
51E	Microphone PF4 key											
		All menu numbers may not be available (depending on the market code).										
52	Split frequency transfer in master/ slave operation	OFF	ON									
53	Permit to write the transferred Split frequencies to the target VFOs.	OFF	ON									
54	TX inhibit	OFF	ON									
55	Packet communication mode	OFF	ON									

## 21 APPENDIX

Menu No.	Function	EX command parameter P5										
		0	1	2	3	4	5	6	7	8	9	Over
56	COM port communication speed	4800	9600									
57	APO (Auto Power Off) function	OFF	60									
58	RC-2000 font in easy operation mode	FONT-1	FONT-2									
59	RC-2000 panel/ TS-2000(X) dot-matrix display contrast	1	2									
60	Display mode for RC-2000	NEGATIVE	POSITIVE									
61A	Repeater mode select	OFF	LOCKED	CROSS								
61B	Repeater TX hold	OFF	ON									
61C	Remote control ID code	000 ~ 999 (3-digit number)										
61D	Acknowledgement signal in external remote control mode	OFF	ON									
61E	External remote control	OFF	ON									
62A	Commander callsign for Sky Command II+	A maximum of 9 characters. See page 83.										
62B	Transporter callsign for Sky Command II+	A maximum of 9 characters. See page 83.										
62C	Sky Command II+ tone frequency	See page 35 for the tone number.										
62D	Sky Command II+ communication speed	1200	9600									
62E	Sky Command II+ mode	OFF	CLIENT	COMMAND	TRANSPORTER							

<b>FA</b>	Reads and sets the VFO A frequency.										Parameters: P1 Specify the frequency in Hz (11-digit). For example, 00014195000 for 14.195 MHz. The blank digits must be 0.	
	Set	1	2	3	4	5	6	7	8	9		10
		F	A	P1	P1	P1	P1	P1	P1	P1		P1
		11	12	13	14	15	16	17	18	19		20
Read	P1	P1	P1	;								
Answer	1	2	3	4	5	6	7	8	9	10		
	F	A	P1	P1	P1	P1	P1	P1	P1	P1		
	11	12	13	14	15	16	17	18	19	20		
	P1	P1	P1	;								

<b>FB</b>	Reads and sets the VFO B frequency.										Parameters: P1 Specify the frequency in Hz (11-digit). For example, 00014195000 for 14.195 MHz. The blank digits must be 0.	
	Set	1	2	3	4	5	6	7	8	9		10
		F	B	P1	P1	P1	P1	P1	P1	P1		P1
		11	12	13	14	15	16	17	18	19		20
Read	P1	P1	P1	;								
Answer	1	2	3	4	5	6	7	8	9	10		
	F	B	P1	P1	P1	P1	P1	P1	P1	P1		
	11	12	13	14	15	16	17	18	19	20		
	P1	P1	P1	;								

<b>FC</b>	Reads and sets the sub-receiver's VFO frequency.										Parameters: P1 Specify the frequency in Hz (11-digit). For example, 00144195000 for 144.195 MHz. The blank digits must be 0. If the invalid frequency step size is used in the P1 parameter, the transceiver automatically sets the nearest frequency.	
	Set	1	2	3	4	5	6	7	8	9		10
		F	C	P1	P1	P1	P1	P1	P1	P1		P1
		11	12	13	14	15	16	17	18	19		20
Read	P1	P1	P1	;								
Answer	1	2	3	4	5	6	7	8	9	10		
	F	C	P1	P1	P1	P1	P1	P1	P1	P1		
	11	12	13	14	15	16	17	18	19	20		
	P1	P1	P1	;								

<b>FD</b>	Reads the filter display dot pattern.										Parameters: P1 00000000 ~ FFFFFFFD (32-bit) The filter width display has 30 dots. MSB represents a dot on the left. The last 2 bits are unused. These bits are set to 0.	
	Set	1	2	3	4	5	6	7	8	9		10
		1	2	3	4	5	6	7	8	9		10
Read	F	D	;									
Answer	1	2	3	4	5	6	7	8	9	10		
	F	D	P1	P1	P1	P1	P1	P1	P1	P1		
	11	12	13	14	15	16	17	18	19	20		
	;											

## 21 APPENDIX

<b>FR</b>	Selects or reads the receiver VFO, M. CH or CALL/ COM.										Parameters: P1 0: VFO A 1: VFO B 2: M.CH 3: CALL  The command is applied to the current CTRL (Control) band.
Set	1	2	3	4	5	6	7	8	9	10	
	F	R	P1	;							
Read	1	2	3	4	5	6	7	8	9	10	
	F	R	;								
Answer	1	2	3	4	5	6	7	8	9	10	
	F	R	P1	;							

<b>FS</b>	Selects or reads the FINE function status.										Parameters: P1 0: FINE function OFF 1: FINE function ON
Set	1	2	3	4	5	6	7	8	9	10	
	F	S	P1	;							
Read	1	2	3	4	5	6	7	8	9	10	
	F	S	;								
Answer	1	2	3	4	5	6	7	8	9	10	
	F	S	P1	;							

<b>FT</b>	Selects or reads the transmitter's VFO, M. CH or CALL/ COM.										Parameters: P1 0: VFO A 1: VFO B 2: M.CH 3: CALL  The command is applied to the current TX band.
Set	1	2	3	4	5	6	7	8	9	10	
	F	T	P1	;							
Read	1	2	3	4	5	6	7	8	9	10	
	F	T	;								
Answer	1	2	3	4	5	6	7	8	9	10	
	F	T	P1	;							

<b>FW</b>	Selects or reads the DSP receive filter width.										Parameters: P1 0000 ~ 9999 (in Hz) CW: 50, 80, 100, 150, 200, 300, 400, 500, 600, 1000, 2000 FSK: 250, 500, 1000, 1500 FM/AM: 0000=Narrow, 0001=Wide  In SSB mode, you cannot use the FW command. Use the SL or SH command instead.
Set	1	2	3	4	5	6	7	8	9	10	
	F	W	P1	P1	P1	P1	;				
Read	1	2	3	4	5	6	7	8	9	10	
	F	W	;								
Answer	1	2	3	4	5	6	7	8	9	10	
	F	W	P1	P1	P1	P1	;				

<b>GT</b>	Selects or reads the AGC constant status.										Parameters: P1 000=OFF 001 (min.) ~ 020 (max.)  GT commands cannot be used in FM mode. The transceiver responds with 3 spaces when the GT command is used in FM mode.
Set	1	2	3	4	5	6	7	8	9	10	
	G	T	P1	P1	P1	;					
Read	1	2	3	4	5	6	7	8	9	10	
	G	T	;								
Answer	1	2	3	4	5	6	7	8	9	10	
	G	T	P1	P1	P1	;					

<b>ID</b>	Reads the transceiver ID number.										Parameters: P1 019: TS-2000
	1	2	3	4	5	6	7	8	9	10	
Read	I	D	:								
	1	2	3	4	5	6	7	8	9	10	
Answer	I	D	P1	P1	P1	:					
	1	2	3	4	5	6	7	8	9	10	

<b>IF</b>	Retrieves the transceiver status.										Parameters: P1 Specify the frequency in Hz. (11-digit) The blank digits must be "0". P2 Frequency step size. P3 RIT/ XIT frequency ±99999 in Hz P4 0: RIT OFF, 1: RIT ON P5 0: XIT OFF, 1: XIT ON P6, P7: Specify the channel bank number. See MC command. P8 0: RX, 1: TX P9 Operating mode. See MD commands for details. P10 See FR and FT commands. P11 Scan status. See SC command. P12 0: Simplex, 1: Split P13 0: OFF, 1: TONE, 2: CTCSS, 3: DCS P14 Tone frequency. See TN command. P15 Shift status. See OS command.  While operating Sky Command II+, the P2 and P15 parameters become blank. The P2 parameter length changes to 5 bytes and the P3 parameter length becomes 5 bytes.
	Set	1	2	3	4	5	6	7	8	9	
Read	I	F	:								
	1	2	3	4	5	6	7	8	9	10	
Answer	I	F	P1	P1	P1	P1	P1	P1	P1	P1	
	11	12	13	14	15	16	17	18	19	20	
	P1	P1	P1	P2	P2	P2	P2	P3	P3	P3	
	21	22	23	24	25	26	27	28	29	30	
	P3	P3	P3	P4	P5	P6	P7	P7	P8	P9	
	31	32	33	34	35	36	37	38	39	40	
	P10	P11	P12	P13	P14	P14	P15	:			

<b>IS</b>	Sets and reads the IF SHIFT function status.										Parameters: P1 space P2 0400 ~ 1000 (in steps of 50) in CW mode  IS commands cannot be used while in SSB, FSK, FM, or AM mode.
	Set	1	2	3	4	5	6	7	8	9	
Read	I	S	:								
	1	2	3	4	5	6	7	8	9	10	
Answer	I	S	P1	P2	P2	P2	P2	:			
	1	2	3	4	5	6	7	8	9	10	

<b>KS</b>	Sets and reads the keying speed of the electric keyer.										Parameters: P1 010 (min.) ~ 060 (max.) [in WPM]
	Set	1	2	3	4	5	6	7	8	9	
Read	K	S	:								
	1	2	3	4	5	6	7	8	9	10	
Answer	K	S	P1	P1	P1	:					
	1	2	3	4	5	6	7	8	9	10	

## 21 APPENDIX

<b>KY</b>	Converts the characters into Morse code.										Parameters: P1 0: Character buffer is available 1: Character buffer is not available (Answer command only. A space is used for Set command.) P2 Enter characters and numbers Available characters are: ABCDEFGHIJKLMNOPQRSTUVWXYZ _ (space) 0123456789 " ' ( ) * + , - . / : = ?
	Set	1	2	3	4	5	6	7	8	9	
	K	Y	P1	P2	P2	P2	P2	P2	P2	P2	P2
	11	12	13	14	15	16	17	18	19	20	
	P2	P2	P2	P2	P2	P2	P2	P2	P2	P2	
	21	22	23	24	25	26	27	28	29	30	
	P2	P2	P2	P2	P2	P2	P2	;			
Read	1	2	3	4	5	6	7	8	9	10	
	K	Y	;								
Answer	1	2	3	4	5	6	7	8	9	10	
	K	Y	P1	;							

<b>LK</b>	Sets and reads the key lock function status.										Parameters: P1 0: Lock function OFF (TS-2000/ TS-B2000) 1: F.LOCK function ON (TS-2000/ TS-B2000) 2: A.LOCK function ON (TS-2000/ TS-B2000) P2 0: LOCK function OFF (RC-2000) 1: LOCK function ON (RC-2000)
	Set	1	2	3	4	5	6	7	8	9	
	L	K	P1	P2	;						
Read	1	2	3	4	5	6	7	8	9	10	
	L	K	;								
Answer	1	2	3	4	5	6	7	8	9	10	
	L	K	P1	P2	;						

<b>LM</b>	Sets and reads the DRU-3A unit or electric keyer recording status.										Parameters: P1 0: Stop recording (Set command only) 0: Recording function is inactive 1: Start recording to CH1 2: Start recording to CH2 3: Start recording to CH3
	Set	1	2	3	4	5	6	7	8	9	
	L	M	P1	;							
Read	1	2	3	4	5	6	7	8	9	10	
	L	M	;								
Answer	1	2	3	4	5	6	7	8	9	10	
	L	M	P1	;							

<b>LT</b>	Sets and reads the ALT function status.										Parameters: P1 0: ALT function OFF 1: ALT function ON
	Set	1	2	3	4	5	6	7	8	9	
	L	T	P1	;							
Read	1	2	3	4	5	6	7	8	9	10	
	L	T	;								
Answer	1	2	3	4	5	6	7	8	9	10	
	L	T	P1	;							

<b>MC</b>	Recalls or reads the Memory channel.										Parameters: P1 _ (space): No bank number 0 ~ 2: Memory bank number P2 00 ~ 99: Channel number  Memory channel numbers from 00 to 99 are treated as Memory bank 0. Memory channel numbers from 100 to 199 are treated as Memory bank 1. Memory channel numbers from 200 to 299 are treated as Memory bank 2.
	Set	1	2	3	4	5	6	7	8	9	
	M	C	P1	P2	P2	;					
Read	1	2	3	4	5	6	7	8	9	10	
	M	C	;								
Answer	1	2	3	4	5	6	7	8	9	10	
	M	C	P1	P2	P2	;					



<b>MD</b>	Recalls or reads the operating mode status.										Parameters: P1
Set	1	2	3	4	5	6	7	8	9	10	1: LSB 2: USB 3: CW 4: FM 5: AM 6: FSK 7: CR-R 8: Reserved 9: FSK-R
	M	D	P1	;							
Read	1	2	3	4	5	6	7	8	9	10	
	M	D	;								
Answer	1	2	3	4	5	6	7	8	9	10	
	M	D	P1	;							

<b>MF</b>	Sets or reads Menu A or B.										Parameters: P1
Set	1	2	3	4	5	6	7	8	9	10	0: Menu A 1: Menu B
	M	F	P1	;							
Read	1	2	3	4	5	6	7	8	9	10	
	M	F	;								
Answer	1	2	3	4	5	6	7	8	9	10	
	M	F	P1	;							

<b>MG</b>	Sets or reads the Microphone gain status.										Parameters: P1
Set	1	2	3	4	5	6	7	8	9	10	000 (min.) ~ 100 (max.)
	M	G	P1	P1	P1	;					
Read	1	2	3	4	5	6	7	8	9	10	
	M	G	;								
Answer	1	2	3	4	5	6	7	8	9	10	
	M	G	P1	P1	P1	;					

<b>ML</b>	Sets or reads the MONITOR function level.										Parameters: P1
Set	1	2	3	4	5	6	7	8	9	10	000: MONITOR OFF 001 (min.) ~ 009 (max.)
	M	L	P1	P1	P1	;					
Read	1	2	3	4	5	6	7	8	9	10	
	M	L	;								
Answer	1	2	3	4	5	6	7	8	9	10	
	M	L	P1	P1	P1	;					

<b>MO</b>	Sets the MONITOR function ON/ OFF in Sky Commander mode.										Parameters: P1
Set	1	2	3	4	5	6	7	8	9	10	0: MONITOR OFF 1: MONITOR ON
	M	O	P1	;							
Read	1	2	3	4	5	6	7	8	9	10	
Answer	1	2	3	4	5	6	7	8	9	10	
	M	O	P1	;							

## 21 APPENDIX

<b>MR</b>	Reads the Memory channel data.										Parameters:
	Set	1	2	3	4	5	6	7	8	9	10
Read	1	2	3	4	5	6	7	8	9	10	P4 Frequency in Hz (11-digit).
	M	R	P1	P2	P3	P3	;				P5 Mode. See MD command.
Answer	1	2	3	4	5	6	7	8	9	10	P6 Lockout status. 0: Lockout OFF, 1: Lockout ON.
	M	R	P1	P2	P3	P3	P4	P4	P4	P4	P7 0: OFF, 1: TONE, 2: CTCSS, 3: DCS.
	11	12	13	14	15	16	17	18	19	20	P8 Tone Number. See page 35.
	P4	P4	P4	P4	P4	P4	P4	P5	P6	P7	P9 CTCSS tone number. See CN command.
	21	22	23	24	25	26	27	28	29	30	P10 DCS code. See QC command.
	P8	P8	P9	P9	P10	P10	P10	P11	P12	P13	P11 REVERSE status.
	31	32	33	34	35	36	37	38	39	40	P12 SHIFT status. See OS command.
	P13	P13	P13	P13	P13	P13	P13	P13	P14	P14	P13 Offset frequency. See OS command.
41	42	43	44	45	46	47	48	49	50	P14 Step size. See ST command.	
P15	P16	P16	P16	P16	P16	P16	P16	P16	;	P15 Memory Group number (0 ~ 9). P16 Memory name. A maximum of 8 characters. Memory channel 290 ~ 299: P1=0 (start frequency), P1=1 (end frequency)	

<b>MU</b>	Sets or reads the Memory Group data.										Parameters:
	Set	1	2	3	4	5	6	7	8	9	10
M		U	P1	P2	P3	P4	P5	P6	P7	P8	P2 Memory Group 1
Read	11	12	13	14	15	16	17	18	19	20	P3 Memory Group 2
	P9	P10	;								P4 Memory Group 3
Answer	1	2	3	4	5	6	7	8	9	10	P5 Memory Group 4
	M	U	;								P6 Memory Group 5
	11	12	13	14	15	16	17	18	19	20	P7 Memory Group 6
	P9	P10	;								P8 Memory Group 7
	11	12	13	14	15	16	17	18	19	20	P9 Memory Group 8
	P9	P10	;								P10 Memory Group 9
										0: Unselected, 1: Selected	

<b>MW</b>	Store the data to the Memory channel.										Parameters:
	1 2 3 4 5 6 7 8 9 10										P1
	M	W	P1	P2	P3	P3	P4	P4	P4	P4	P2, P3
	11 12 13 14 15 16 17 18 19 20										Bank and channel number. See MC command.
	P4	P4	P4	P4	P4	P4	P4	P5	P6	P7	P4
	21 22 23 24 25 26 27 28 29 30										Frequency in Hz (11-digit).
	P8	P8	P9	P9	P10	P10	P10	P11	P12	P13	P5
	31 32 33 34 35 36 37 38 39 40										Mode. See MD command.
	P13	P13	P13	P13	P13	P13	P13	P13	P14	P14	P6
	41 42 43 44 45 46 47 48 49 50										Lockout status. 0: Lockout OFF, 1: Lockout ON
Set	1 2 3 4 5 6 7 8 9 10										P7
	P8	P8	P9	P9	P10	P10	P10	P11	P12	P13	0: OFF, 1: TONE, 2: CTCSS, 3: DCS
	31 32 33 34 35 36 37 38 39 40										P8
	P13	P13	P13	P13	P13	P13	P13	P13	P14	P14	Tone Number. See page 35.
	41 42 43 44 45 46 47 48 49 50										P9
	P15	P16	P16	P16	P16	P16	P16	P16	P16	;	CTCSS tone number. See CN command.
	1 2 3 4 5 6 7 8 9 10										P10
	1 2 3 4 5 6 7 8 9 10										DCS code. See QC command.
	1 2 3 4 5 6 7 8 9 10										P11
	1 2 3 4 5 6 7 8 9 10										REVERSE status.
Read	1 2 3 4 5 6 7 8 9 10										P12
	1 2 3 4 5 6 7 8 9 10										SHIFT status. See OS command.
Answer	1 2 3 4 5 6 7 8 9 10										P13
	1 2 3 4 5 6 7 8 9 10										Offset frequency. See OS command.
1 2 3 4 5 6 7 8 9 10										P14	
1 2 3 4 5 6 7 8 9 10										Step size. See ST command.	
1 2 3 4 5 6 7 8 9 10										P15	
1 2 3 4 5 6 7 8 9 10										Memory Group number (0 ~ 9).	
1 2 3 4 5 6 7 8 9 10										P16	
1 2 3 4 5 6 7 8 9 10										Memory name. A maximum of 8 characters.	
1 2 3 4 5 6 7 8 9 10										Memory channel 290 ~ 299: P1=0 (start frequency), P1=1 (end frequency)	

<b>NB</b>	Set or reads the NB (Noise Blanker) function status.										Parameters:
	1 2 3 4 5 6 7 8 9 10										P1
	N	B	P1	;							0: NB OFF 1: NB ON
	1 2 3 4 5 6 7 8 9 10										
Set	1 2 3 4 5 6 7 8 9 10										
	N	B	;								
Read	1 2 3 4 5 6 7 8 9 10										
	N	B	;								
Answer	1 2 3 4 5 6 7 8 9 10										
	N	B	P1	;							

<b>NL</b>	Set or reads the NB (Noise Blanker) level.										Parameters:
	1 2 3 4 5 6 7 8 9 10										P1
	N	L	P1	P1	P1	;					001 (min.) ~ 010 (max.)
	1 2 3 4 5 6 7 8 9 10										000 is treated as 001. 010 ~ 999 are treated as 010.
Set	1 2 3 4 5 6 7 8 9 10										
	N	L	;								
Read	1 2 3 4 5 6 7 8 9 10										
	N	L	;								
Answer	1 2 3 4 5 6 7 8 9 10										
	N	L	P1	P1	P1	;					

<b>NR</b>	Sets or reads the NR (Noise Reduction) function status.										Parameters:
	1 2 3 4 5 6 7 8 9 10										P1
	N	R	P1	;							0: NR OFF 1: NR1 ON 2: NR2 ON
	1 2 3 4 5 6 7 8 9 10										
Set	1 2 3 4 5 6 7 8 9 10										
	N	R	;								
Read	1 2 3 4 5 6 7 8 9 10										
	N	R	;								
Answer	1 2 3 4 5 6 7 8 9 10										
	N	R	P1	;							

## 21 APPENDIX

<b>NT</b>	Sets or reads the Auto Notch function status.										Parameters: P1 0: Auto Notch OFF 1: Auto Notch ON	
	Set	1	2	3	4	5	6	7	8	9		10
		N	T	P1	;							
	Read	1	2	3	4	5	6	7	8	9		10
N		T	;									
Answer	1	2	3	4	5	6	7	8	9	10		
	N	T	P1	;								

<b>OF</b>	Sets or reads the Offset frequency information.										Parameters: P1 000000000 ~ 059950000 in steps of 50000 Offset frequency in Hz (9-digit). Unused digits must be 0.	
	Set	1	2	3	4	5	6	7	8	9		10
		O	F	P1	P1	P1	P1	P1	P1	P1		P1
		11	12	13	14	15	16	17	18	19		20
	P1	;										
Read	1	2	3	4	5	6	7	8	9	10		
	O	F	;									
Answer	1	2	3	4	5	6	7	8	9	10		
	O	F	P1	P1	P1	P1	P1	P1	P1	P1		
	11	12	13	14	15	16	17	18	19	20		
	P1	;										

<b>OI</b>	Opposite Band information										Parameters: P1 Specify the frequency in Hz (11 digits) The blank digits must be "0". P2 Frequency step size P3 RIT/ XIT frequency $\pm 99999$ in Hz P4 0: RIT OFF, 1: RIT ON P5 0: XIT OFF, 1: XIT ON P6, P7: Specify the channel bank number. See MC command. P8 0: RX, 1: TX P9 Operating mode. See MD commands for details. P10 See FR and FT commands. P11 Scan status. See SC command. P12 0: Simplex, 1: Split P13 0: OFF, 1: TONE, 2: CTCSS, 3: DCS P14 Tone frequency. See TN command. P15 Shift status. See OS command.  While operating Sky Command II+, the P2 and P15 parameters become blank. The P2 parameter length changes to 5 bytes and the P3 parameter length becomes 5 bytes.	
	Set	1	2	3	4	5	6	7	8	9		10
	Read	1	2	3	4	5	6	7	8	9		10
O		I	;									
Answer	1	2	3	4	5	6	7	8	9	10		
	O	I	P1	P1	P1	P1	P1	P1	P1	P1		
	11	12	13	14	15	16	17	18	19	20		
	P1	P1	P1	P2	P2	P2	P2	P3	P3	P3		
	21	22	23	24	25	26	27	28	29	30		
	P3	P3	P3	P4	P5	P6	P7	P7	P8	P9		
	31	32	33	34	35	36	37	38	39	40		
	P10	P11	P12	P13	P14	P14	P15	;				

<b>OS</b>	Sets or reads the offset function status.										Parameters: P1 0: Simplex 1: + 2: - 3: = (All E-types)  Valid only in FM mode. SPLIT function must be OFF.	
	Set	1	2	3	4	5	6	7	8	9		10
		O	S	P1	;							
	Read	1	2	3	4	5	6	7	8	9		10
		O	S	;								
Answer	1	2	3	4	5	6	7	8	9	10		
		O	S	P1	;							

<b>PA</b>	Sets or reads the pre-amplifier function status.										Parameters: P1 0: Pre-amplifier OFF (main transceiver) 1: Pre-amplifier ON (main transceiver) P2 (Answer only) 0: Pre-amplifier ON (sub-receiver) 1: Pre-amplifier OFF (sub-receiver)  If same frequency band is selected for the main transceiver and the sub-receiver, both pre-amplifiers are turned ON or OFF at the same time.	
	Set	1	2	3	4	5	6	7	8	9		10
		P	A	P1	;							
	Read	1	2	3	4	5	6	7	8	9		10
		P	A	;								
Answer	1	2	3	4	5	6	7	8	9	10		
		P	A	P1	P2	;						

<b>PB</b>	Sets or reads the DRU-3A or electric keyer playback status.										Parameters: P1 0: Inactive 1: Playback CH1 2: Playback CH2 3: Playback CH3	
	Set	1	2	3	4	5	6	7	8	9		10
		P	B	P1	;							
	Read	1	2	3	4	5	6	7	8	9		10
		P	B	;								
Answer	1	2	3	4	5	6	7	8	9	10		
		P	B	P1	;							

<b>PC</b>	Sets or reads the output power.										Parameters: P1 005 ~ 100 (in steps of 1)  Refer to the Specifications for the minimum and maximum power for each operating frequency band and mode.  If the power is less than 1 watt, the next power level is used. ex: 2.5 W = 003, 0.5 W= 001	
	Set	1	2	3	4	5	6	7	8	9		10
		P	C	P1	P1	P1	;					
	Read	1	2	3	4	5	6	7	8	9		10
		P	C	;								
Answer	1	2	3	4	5	6	7	8	9	10		
		P	C	P1	P1	P1	;					

<b>PI</b>	Stores in the Programable Memory channel.										Parameters: P1 1 ~ 5 (PM channel number)	
	Set	1	2	3	4	5	6	7	8	9		10
		P	I	P1	;							
	Read	1	2	3	4	5	6	7	8	9		10
Answer	1	2	3	4	5	6	7	8	9	10		

## 21 APPENDIX

<b>PK</b>	Reads the Packet Cluster data.										Parameters: This command is used in conjunctin with the AI command.
Set	1	2	3	4	5	6	7	8	9	10	P1 Frequency in Hz (11-digit)
Read	1	2	3	4	5	6	7	8	9	10	P2 Callsign (12-digit)
Answer	1	2	3	4	5	6	7	8	9	10	P3 Comments (20-digit)
	P	K	P1	P1	P1	P1	P1	P1	P1	P1	
	11	12	13	14	15	16	17	18	19	20	
	P1	P1	P1	P2	P2	P2	P2	P2	P2	P2	
	21	22	23	24	25	26	27	28	29	30	
	P2	P2	P2	P2	P2	P3	P3	P3	P3	P3	
	31	32	33	34	35	36	37	38	39	40	
	P3	P3	P3	P3	P3	P3	P3	P3	P3	P3	
	41	42	43	44	45	46	47	48	49	50	
	P3	P3	P3	P3	P3	P4	P4	P4	P4	P4	
	51	52	53	54	55	56	57	58	59	60	P4 Time (5-digit)
	;										

<b>PL</b>	Sets and reads the Speech Processor input/ output level.										Parameters: P1 Input level: 000 (min.) ~ 100 (max.) P2 Output level: 000 (min.) ~ 100 (max.)
Set	1	2	3	4	5	6	7	8	9	10	P1 Input level: 000 (min.) ~ 100 (max.)
	P	L	P1	P1	P1	P2	P2	P2	;		
Read	1	2	3	4	5	6	7	8	9	10	P2 Output level: 000 (min.) ~ 100 (max.)
	P	L	;								
Answer	1	2	3	4	5	6	7	8	9	10	
	P	L	P1	P1	P1	P2	P2	P2	;		

<b>PM</b>	Recalls the PM (Programmable Memory).										Parameters: P1 0: PM OFF 1 ~ 5 (PM channel number)
Set	1	2	3	4	5	6	7	8	9	10	P1 0: PM OFF 1 ~ 5 (PM channel number)
	P	M	P1	;							
Read	1	2	3	4	5	6	7	8	9	10	
	P	M	;								
Answer	1	2	3	4	5	6	7	8	9	10	
	P	M	P1	;							

<b>PR</b>	Sets or reads the Speech Processor function ON/ OFF.										Parameters: P1 0: Speech Processor OFF 1: Speech Processor ON
Set	1	2	3	4	5	6	7	8	9	10	P1 0: Speech Processor OFF 1: Speech Processor ON
	P	R	P1	;							
Read	1	2	3	4	5	6	7	8	9	10	
	P	R	;								
Answer	1	2	3	4	5	6	7	8	9	10	
	P	R	P1	;							

<b>PS</b>	Sets or reads the Power ON/ OFF status.										Parameters: P1 0: Power ON 1: Power OFF	
Set	1 2 3 4 5 6 7 8 9 10											
	P	S	P1	;								
Read	1 2 3 4 5 6 7 8 9 10											
	P	S	;									
Answer	1 2 3 4 5 6 7 8 9 10											
	P	S	P1	;								

<b>QC</b>	Sets or reads the DCS code.										Parameters: P1 All available 103 DCS codes are numbered sequentially from 000 to 103. ex.: 000: 023 (DCS code) ... 103: 754 (DCS code)	
Set	1 2 3 4 5 6 7 8 9 10											
	Q	C	P1	P1	P1	;						
Read	1 2 3 4 5 6 7 8 9 10											
	Q	C	;									
Answer	1 2 3 4 5 6 7 8 9 10											
	Q	C	P1	P1	P1	;						

<b>QI</b>	Store the settings in the Quick Memory.										Parameters: None	
Set	1 2 3 4 5 6 7 8 9 10											
	Q	I	;									
Read	1 2 3 4 5 6 7 8 9 10											
Answer	1 2 3 4 5 6 7 8 9 10											

<b>QR</b>	Sets or reads the Quick Memory channel data.										Parameters: P1 0: Quick Memory OFF 1: Quick Memory ON P2 0 ~ 9: Quick Memory channel number	
Set	1 2 3 4 5 6 7 8 9 10											
	Q	R	P1	P2	;							
Read	1 2 3 4 5 6 7 8 9 10											
	Q	R	;									
Answer	1 2 3 4 5 6 7 8 9 10											
	Q	R	P1	P2	;							

<b>RA</b>	Sets or reads the Attenuator function status.										Parameters: P1 00: ATT OFF 01 ~ 99: ATT ON  If same frequency band is selected for the main transceiver and the sub-receiver, both attenuators are turned ON or OFF at the same time.	
Set	1 2 3 4 5 6 7 8 9 10											
	R	A	P1	P1	;							
Read	1 2 3 4 5 6 7 8 9 10											
	R	A	;									
Answer	1 2 3 4 5 6 7 8 9 10											
	R	A	P1	P1	P2	P2	;					

## 21 APPENDIX

<b>RC</b>	Clears the RIT offset frequency.										Parameters: None
Set	1	2	3	4	5	6	7	8	9	10	
	R	C	;								
Read	1	2	3	4	5	6	7	8	9	10	
Answer	1	2	3	4	5	6	7	8	9	10	

<b>RD</b>	Move the RIT offset frequency down. Slow down the scan speed in Scan mode.										Parameters: P1 00000 ~ 99999 (the offset frequency in Hz) P2 1 ~ 9: Scan speed When Scan is OFF: If no parameter is specified, the frequency goes down 1 step. When Scan is ON: RD; to read the current scan speed. RDnnnnn; (nnnnn = Any number) to slow the scan speed 1 step.
Set	1	2	3	4	5	6	7	8	9	10	
	R	D	P1	P1	P1	P1	P1	;			
Read	1	2	3	4	5	6	7	8	9	10	
	R	D	;								
Answer	1	2	3	4	5	6	7	8	9	10	
	R	D	P2	;							

<b>RG</b>	Sets or read the RF gain status.										Parameters: P1 000 (min.) ~ 255 (max.)
Set	1	2	3	4	5	6	7	8	9	10	
	R	G	P1	P1	P1	;					
Read	1	2	3	4	5	6	7	8	9	10	
	R	G	;								
Answer	1	2	3	4	5	6	7	8	9	10	
	R	G	P1	P1	P1	;					

<b>RL</b>	Sets or reads the Noise Reduction level.										Parameters: P1 When the NR1 is ON: 00 = AUTO, 01 ~ 09 When the NR2 is ON: 00 (2 ms) ~ 09 (20 ms) in steps of 2 ms
Set	1	2	3	4	5	6	7	8	9	10	
	R	L	P1	P1	;						
Read	1	2	3	4	5	6	7	8	9	10	
	R	L	;								
Answer	1	2	3	4	5	6	7	8	9	10	
	R	L	P1	P1	;						

<b>RM</b>	Sets or reads the Meter function.										Parameters: P1 Selects the meter scale 0: Unselected 1: SWR 2: COMP 3: ALC P2 Meter value in dots: 0000 ~ 0030
Set	1	2	3	4	5	6	7	8	9	10	
	R	M	P1	;							
Read	1	2	3	4	5	6	7	8	9	10	
	R	M	;								
Answer	1	2	3	4	5	6	7	8	9	10	
	R	M	P1	P2	P2	P2	P2	;			



<b>RT</b>	Sets or reads the RIT function status.										Parameters: P1 0: RIT function OFF 1: RIT function ON									
Set	1	2	3	4	5	6	7	8	9	10	R	T	P1	;						
Read	1	2	3	4	5	6	7	8	9	10	R	T	;							
Answer	1	2	3	4	5	6	7	8	9	10	R	T	P1	;						

<b>RU</b>	Moves the RIT offset frequency up. Speed up the scan speed in Scan mode.										Parameters: P1 00000 ~ 99999 (the offset frequency in Hz) P2 1 ~ 9: Scan speed When Scan is OFF: If no parameter is specified, the frequency goes 1 step up. When Scan is ON: RU; to read the current scan speed. RUnnnnn; (nnnnn = Any number) to speed the scan speed 1 step up.									
Set	1	2	3	4	5	6	7	8	9	10	R	U	P1	P1	P1	P1	P1	;		
Read	1	2	3	4	5	6	7	8	9	10	R	U	;							
Answer	1	2	3	4	5	6	7	8	9	10	R	U	P2	;						

<b>RX</b>	Sets the receiver function status.										Parameters: P1 0: Main transceiver 1: Sub-receiver									
Set	1	2	3	4	5	6	7	8	9	10	R	X	;							
Read	1	2	3	4	5	6	7	8	9	10										
Answer	1	2	3	4	5	6	7	8	9	10	R	X	P1	;						

<b>SA</b>	Sets or reads the Satellite mode status.										Parameters: P1 0: Satellite mode OFF 1: Satellite mode ON P2 0 ~ 9: Satellite Memory Channel number P3 0: Main transceiver (uplink)/ Sub-receiver (downlink) 1: Main transceiver (downlink)/ Sub-receiver (uplink) P4 0: CTRL is on the main transceiver 1: CTRL is on the sub-receiver P5 0: TRACE OFF, 1: TRACE ON P6 0: TRACE REV. OFF, 1: TRACE REV ON P7 0: MULTI/ CH control (VFO mode) 1: MULTI/ CH control (Memory channel) P8 Satellite Channel name (8 characters) Use the FA (downlink) or FB (uplink) command to change the frequencies.									
Set	1	2	3	4	5	6	7	8	9	10	S	A	P1	P2	P3	P4	P5	P6	P7	;
Read	1	2	3	4	5	6	7	8	9	10	S	A	;							
Answer	1	2	3	4	5	6	7	8	9	10	S	A	P1	P2	P3	P4	P5	P6	P7	P8
	11	12	13	14	15	16	17	18	19	20										
	P8	P8	P8	P8	P8	P8	P8	P8	;											

## 21 APPENDIX

<b>SB</b>	Sets or reads the SUB, TF-W status.										Parameters: P1 0: SUB (TF-W) OFF 1: SUB (TF-W) ON	
	Set	1	2	3	4	5	6	7	8	9		10
		S	B	P1	;							
	Read	1	2	3	4	5	6	7	8	9		10
	S	B	;									
Answer	1	2	3	4	5	6	7	8	9	10		
	S	B	P1	;								

<b>SC</b>	Sets or reads the SCAN function status.										Parameters: P1 0: Scan OFF 1: Scan ON 2: MHz Scan ON 3: Visual Scan ON 4: Tone Scan ON 5: CTCSS Scan ON 6: DCS Scan ON	
	Set	1	2	3	4	5	6	7	8	9		10
		S	C	P1	;							
	Read	1	2	3	4	5	6	7	8	9		10
	S	C	;									
Answer	1	2	3	4	5	6	7	8	9	10		
	S	C	P1	;								

<b>SD</b>	Sets or reads the CW break-in time delay.										Parameters: P1 0000 ~ 1000 ms (in steps of 50 ms) 0000 is FBK (Full break-in)	
	Set	1	2	3	4	5	6	7	8	9		10
		S	D	P1	P1	P1	P1	;				
	Read	1	2	3	4	5	6	7	8	9		10
	S	D	;									
Answer	1	2	3	4	5	6	7	8	9	10		
	S	D	P1	P1	P1	P1	;					

<b>SH</b>	Sets or reads the DSP filter settings.										Parameters: P1 00 ~ 11 SSB/ FM (Hz) 00: 1400, 01: 1600, 02: 1800, 03: 2000, 04: 2200, 05: 2400, 06: 2600, 07: 2800, 08: 3000, 09: 3400, 10: 4000, 11: 5000 AM (Hz) 00: 2500, 01: 3000, 02: 4000, 03: 5000 When the Packet Filter (Menu No. 50A) is ON, 00: 170 Hz, 01: 1930, 02: 2160, 03: PSK	
	Set	1	2	3	4	5	6	7	8	9		10
		S	H	P1	P1	;						
	Read	1	2	3	4	5	6	7	8	9		10
	S	H	;									
Answer	1	2	3	4	5	6	7	8	9	10		
	S	H	P1	P1	;							

<b>SI</b>	Enters the Satellite memory name.										Parameters: P1 0 ~ 9 (Channel number) P2 Satellite memory channel name (A maximum of 8 characters)	
	Set	1	2	3	4	5	6	7	8	9		10
		S	I	P1	P2	P2	P2	P2	P2	P2		P2
		11	12	13	14	15	16	17	18	19		20
	P2	;										
Read	1	2	3	4	5	6	7	8	9	10		
Answer	1	2	3	4	5	6	7	8	9	10		

<b>SL</b>	Sets or reads the DSP filter settings.										Parameters: P1 00 ~ 11 SSB/ FM (Hz) 00: 10 (0), 01: 50, 02: 100, 03: 200, 04: 300, 05: 400, 06: 500 07: 600, 08: 700, 09: 800, 10: 900, 11: 1000 AM (Hz) 00: 10 (0), 01: 100, 02: 200, 03: 500  When the Packet Filter (Menu No. 50A) is ON, 00: WIDE, 01: NAR	
	Set	1	2	3	4	5	6	7	8	9		10
	Read	S	L	P1	P1	;						
	Answer	S	L	P1	P1	;						

<b>SM</b>	Reads the S-meter status.										Parameters: P1 0: Main transceiver 1: Sub-receiver 2: Main transceiver S-meter level 3: Sub-receiver S-meter level P2 Meter readings 0000 ~ 0030 (Main transceiver) 0000 ~ 0015 (Sub-receiver)	
	Set	1	2	3	4	5	6	7	8	9		10
	Read	S	M	P1	;							
	Answer	S	M	P1	P2	P2	P2	P2	;			

<b>SQ</b>	Sets and reads the squelch level.										Parameters: P1 0: Main transceiver 1: Sub-receiver P2 Squelch level 000 ~ 255	
	Set	1	2	3	4	5	6	7	8	9		10
	Read	S	Q	P1	;							
	Answer	S	Q	P1	P2	P2	P2	;				

<b>SR</b>	Resets the transceiver.										Parameters: P1 1: VFO reset 2: Master reset	
	Set	1	2	3	4	5	6	7	8	9		10
	Read											
	Answer											

<b>SS</b>	Sets or reads the Program Scan pause frequency.										Parameters: P1 0: Reserved 1: Set 2: All clear  When selecting memory channel 290 ~ 299, use the DN or UP command to set the frequency. Then, use this command to set the Program Scan pause frequency. Using the IF command, you can read the current frequency.	
	Set	1	2	3	4	5	6	7	8	9		10
	Read	S	S	;								
	Answer	S	S	P1	;							

## 21 APPENDIX

<b>ST</b>	Sets or reads the MULTI/ CH control frequency steps.										Parameters: P1 SSB/ CW/ FSK mode: 00 ~ 03 00: 1 kHz, 01: 2.5 kHz, 02: 5 kHz, 03: 10 kHz AM/ FM mode: 00 ~ 09 00: 5 kHz, 01: 6.25 kHz, 02: 10 kHz, 03: 12.5 kHz, 04: 15 kHz, 05: 20 kHz, 06: 25 kHz, 07: 30 kHz, 08: 50 kHz, 09: 100 kHz									
Set	1	2	3	4	5	6	7	8	9	10	S	T	P1	P1	;					
Read	1	2	3	4	5	6	7	8	9	10	S	T	;							
Answer	1	2	3	4	5	6	7	8	9	10	S	T	P1	P1	;					

<b>SU</b>	Sets or reads the Program Scan pause frequency.										Parameters: P1 0: Program Scan group 1: Memory Scan group P2 Group 0. 0: Unselected, 1 ~ 9: Selected P3 Group 1. 0: Unselected, 1 ~ 9: Selected P4 Group 2. 0: Unselected, 1 ~ 9: Selected P5 Group 3. 0: Unselected, 1 ~ 9: Selected P6 Group 4. 0: Unselected, 1 ~ 9: Selected P7 Group 5. 0: Unselected, 1 ~ 9: Selected P8 Group 6. 0: Unselected, 1 ~ 9: Selected P9 Group 7. 0: Unselected, 1 ~ 9: Selected P10 Group 8. 0: Unselected, 1 ~ 9: Selected P11 Group 9. 0: Unselected, 1 ~ 9: Selected									
Set	1	2	3	4	5	6	7	8	9	10	S	U	P1	P2	P3	P4	P5	P6	P7	P8
	11	12	13	14	15	16	17	18	19	20										
	P9	P10	P11	;																
Read	1	2	3	4	5	6	7	8	9	10	S	U	P1	;						
Answer	1	2	3	4	5	6	7	8	9	10	S	U	P1	P2	P3	P4	P5	P6	P7	P8
	11	12	13	14	15	16	17	18	19	20										
	P9	P10	P11	;																

<b>SV</b>	Execute the Memory Transfer function.										Parameters: No parameter									
Set	1	2	3	4	5	6	7	8	9	10	S	V	;							
Read	1	2	3	4	5	6	7	8	9	10										
Answer	1	2	3	4	5	6	7	8	9	10										

<b>TC</b>	Sets or reads the internal TNC mode.										Parameters: P1 _ (space) is used P2 0: Packet communication mode 1: PC Control command mode Key in "TC 0" to enter Packet communication mode. Key in "TC 1" to return to PC Control command mode.									
Set	1	2	3	4	5	6	7	8	9	10	T	C	P1	P2	;					
Read	1	2	3	4	5	6	7	8	9	10	T	C	;							
Answer	1	2	3	4	5	6	7	8	9	10	T	C	P1	P2	;					

<b>TD</b>	Sends the DTMF memory channel data.										Parameters: P1 00 ~ 09 (DTMF memory channel number)
Set	1	2	3	4	5	6	7	8	9	10	If no data is stored in the channel, no data is sent.
	T	D	P1	P1	;						
Read	1	2	3	4	5	6	7	8	9	10	
Answer	1	2	3	4	5	6	7	8	9	10	

<b>TI</b>	Reads the TNC LED status.										Parameters: P1 0: 9.6k LED is OFF, 1: 9.6k LED is ON P2 0: STA LED is OFF, 1: STA LED is ON P3 0: CON LED is OFF, 1: CON LED is ON
Set	1	2	3	4	5	6	7	8	9	10	
Read	1	2	3	4	5	6	7	8	9	10	
	T	I	;								
Answer	1	2	3	4	5	6	7	8	9	10	
	T	I	P1	P2	P3	;					

<b>TN</b>	Sets or reads the sub-tone frequency.										Parameters: P1 01 ~ 39  Refer to page 35 for the tone numbers.
Set	1	2	3	4	5	6	7	8	9	10	
	T	N	P1	P1	;						
Read	1	2	3	4	5	6	7	8	9	10	
	T	N	;								
Answer	1	2	3	4	5	6	7	8	9	10	
	T	N	P1	P1	;						

<b>TO</b>	Sets or reads the TONE function ON/ OFF.										Parameters: P1 0: TONE OFF 1: TONE ON 2: Emulates switching TONE ON (Set only) 3: Emulates switching TONE OFF (Set only)
Set	1	2	3	4	5	6	7	8	9	10	
	T	O	P1	;							
Read	1	2	3	4	5	6	7	8	9	10	
	T	O	;								
Answer	1	2	3	4	5	6	7	8	9	10	
	T	O	P1	;							

<b>TS</b>	Sets or reads the TF-SET function status.										Parameters: P1 0: TF-SET OFF 1: TF-SET ON When the transceiver is operating in simplex mode. P1 0: REVERSE ON 1: REVERSE OFF Every time you send TS1; the REVERSE function toggles.
Set	1	2	3	4	5	6	7	8	9	10	
	T	S	P1	;							
Read	1	2	3	4	5	6	7	8	9	10	
	T	S	;								
Answer	1	2	3	4	5	6	7	8	9	10	
	T	S	P1	;							

## 21 APPENDIX

<b>TX</b>	Sets the transceiver in TX mode.										Parameters: P1 0: Transmits on the main transceiver's frequency band 1: Transmits on the sub-receiver's frequency band
Set	1	2	3	4	5	6	7	8	9	10	
	T	X	P1	;							
Read	1	2	3	4	5	6	7	8	9	10	
Answer	1	2	3	4	5	6	7	8	9	10	
	T	X	P1	;							

<b>TY</b>	Sets or reads the microprocessor firmware type.										Parameters: P1 Reserved P2 0: Overseas type 1: Japanese 100 W type 2: Japanese 20 W type
Set	1	2	3	4	5	6	7	8	9	10	
Read	1	2	3	4	5	6	7	8	9	10	
	T	Y	;								
Answer	1	2	3	4	5	6	7	8	9	10	
	T	Y	P1	P1	P2	;					

<b>UL</b>	Detects the PLL unlock status.										Parameters: P1 0: Lock 1: Unlock
Set	1	2	3	4	5	6	7	8	9	10	
Read	1	2	3	4	5	6	7	8	9	10	
Answer	1	2	3	4	5	6	7	8	9	10	
	U	L	P1	;							

<b>UP</b>	Emulates the microphone UP key.										Parameters: P1 00 ~ 99  If no P1 parameter is specified, the command is interpreted as 1 step up. In Memory mode and Quick Memory mode, commands without parameters are treated as Memory channel up commands. With parameters, they are treated as frequency up commands.
Set	1	2	3	4	5	6	7	8	9	10	
	U	P	P1	P1	;						
Read	1	2	3	4	5	6	7	8	9	10	
Answer	1	2	3	4	5	6	7	8	9	10	

<b>VD</b>	Sets or reads the VOX delay time.										Parameters: P1 0000 ~ 3000 ms (in steps of 150)
Set	1	2	3	4	5	6	7	8	9	10	
	V	D	P1	P1	P1	P1	;				
Read	1	2	3	4	5	6	7	8	9	10	
	V	D	;								
Answer	1	2	3	4	5	6	7	8	9	10	
	V	D	P1	P1	P1	P1	;				

<b>VG</b>	Sets or reads the VOX GAIN.										Parameters: P1 000 ~ 009										
Set	1	2	3	4	5	6	7	8	9	10	V	G	P1	P1	P1	;					
Read	1	2	3	4	5	6	7	8	9	10	V	G	;								
Answer	1	2	3	4	5	6	7	8	9	10	V	G	P1	P1	P1	;					

<b>VR</b>	Emulates the VOICE1 or VOICE2 key.										Parameters: P1 0: VOICE1 1: VOICE2										
Set	1	2	3	4	5	6	7	8	9	10	V	R	P1	;							
Read	1	2	3	4	5	6	7	8	9	10											
Answer	1	2	3	4	5	6	7	8	9	10											

<b>VX</b>	Sets or reads the VOX function status.										Parameters: P1 0: VOX OFF 1: VOX ON										
Set	1	2	3	4	5	6	7	8	9	10	V	X	P1	;							
Read	1	2	3	4	5	6	7	8	9	10	V	X	;								
Answer	1	2	3	4	5	6	7	8	9	10	V	X	P1	;							

<b>XT</b>	Sets or reads the XIT function status.										Parameters: P1 0: XIT OFF 1: XIT ON										
Set	1	2	3	4	5	6	7	8	9	10	X	T	P1	;							
Read	1	2	3	4	5	6	7	8	9	10	X	T	;								
Answer	1	2	3	4	5	6	7	8	9	10	X	T	P1	;							

- AF Gain ..... 18, 46
- AGC ..... 38, 103
- ALT ..... 72
- AM
  - Narrow Bandwidth for ..... 29
  - Transmission ..... 29
- Amplifier, HF Linear
  - Connection (REMOTE) ..... 94
- Amplifier, 50 MHz, VHF, UHF and 1.2 GHz Connection (EXT.CONT) ..... 96
- AMTOR
  - Connection (ACC 2) ..... 95
  - Operation ..... 52
- Antenna
  - ANT1/ ANT2 ..... 72
  - Connection ..... 13
- Antenna Tuner
  - Operation ..... 72
- ASC ..... 34
- Attenuator ..... 8, 57, 73, 77
- Automatic Antenna Tuner ..... 72
  - Presetting ..... 73
- Automatic Gain Control ..... 38, 103
- Automatic Simplex Check ..... 34
- Auto Mode ..... 73
- Auto Weighting ..... 42
- A=B ..... 38
- Bail, Utilizing ..... 2
- Band, Selecting a ..... 18
- Beat Cancel ..... 56
- Beep Function ..... 74
- Break-in, Full/Semi ..... 42
- Bug Key Function ..... 43
- Call Channel ..... 75
- Carrier-operated mode ..... 68
- Cleaning ..... 99
- Clover
  - Connection (ACC 2) ..... 94
  - Operation ..... 52
- COM Connector ..... 113
- Computer Control
  - Commands ..... 114
  - Communication Parameters ..... 81
  - Connection ..... 81
  - Connector (COM) ..... 93
- Control Band ..... 45
- CTCSS
  - Freq. ID Scan ..... 35
- CW
  - Auto TX in TX Mode ..... 44
  - Break-in, Full ..... 42
  - Break-in, Semi ..... 42
  - Frequency Correction for ..... 44
  - Key jack ..... 3
  - Message Memory ..... 43
  - Pitch ..... 30
  - Reverse (Receive) ..... 44
  - Reverse Keying Weight Ratio ..... 42
  - Sidetone, TX ..... 30
  - Sidetone, Volume ..... 30, 44
  - Transmission ..... 30
  - Zero Beat, Auto ..... 30
- DCS
  - Code ID Scan ..... 36
- Demonstration Mode ..... 99
- Digital Recording Unit (optional)
  - Erasing a Recorded Message ..... 90
  - Interval Time, Changing ..... 90
  - Playback ..... 89
  - Playback Volume ..... 90
  - Recording ..... 89
- Direct Frequency Entry ..... 37
- Display
  - Brightness ..... 75
  - Contrast ..... 75
- DRU-3A, Installation ..... 97
- DSP
  - Auto Beat Cancel ..... 56
  - Changing the Receive Filter
    - Bandwidth ..... 55
    - DSP Filters ..... 55
    - Manual Beat Cancel ..... 56
    - Noise Reduction 1 ..... 56
    - Noise Reduction 2 ..... 56
    - Notch Filter ..... 56
- DTMF ..... 75
  - Entering, tones ..... 75
  - Manual, Dialing ..... 75
  - Pause Period ..... 76
  - Tone Time Length ..... 76
- Electric Keyer ..... 42
  - Auto Weighting ..... 42
  - Bug Key Function ..... 43
  - Changing Keying Speed ..... 42
  - Messages, Checking ..... 43
  - Messages, Storing ..... 43
  - Messages, Transmitting ..... 43
  - Reverse Keying Weight Ratio ..... 42
- External Antenna Tuner ..... 94
- External Speakers ..... 3, 78
- FAX/Facsimile
  - Connection (ACC2) ..... 95
  - Operation ..... 52
- Fine Tuning ..... 38
- F Lock ..... 8, 77
- FM
  - Band Plan ..... 34
  - CTCSS Operation ..... 35
  - DCS Operation ..... 36
  - Narrow Bandwidth for ..... 29
  - Repeater Operation ..... 32
  - RX IF Filter ..... 29
  - Sub-audible Tone ..... 33, 35
  - Subtone, Type ..... 33
  - Transmission ..... 28
  - TX Deviation ..... 29
- Frequency
  - Direct, Entry ..... 37
  - Fine Tuning ..... 38
  - Lock ..... 77
  - Rounding ..... 37
  - Selecting your ..... 19, 37
  - Step Size ..... 37
- Front Panel Meter ..... 19
- FSK ..... (see RTTY)
- Full Reset ..... 92
- Fuses, Replacing ..... 2
- Gain
  - AF ..... 18, 46
  - RF ..... 18
- G-TOR™
  - Connection (ACC 2) ..... 95
  - Operation ..... 52
- Harmonics, TX Signal ..... 103
- Headphones (PHONES) ..... 3, 8, 78
- HF RX Antenna ..... 76
- IF Filter
  - Bandwidth Change ..... 55
  - Shift ..... 55
- Internal Beats ..... 103
- Key Jack (PADDLE/KEY) ..... 3
- Keyer, Electronic
  - Auto Weighting ..... 42
  - Bug Key Function ..... 43
  - Changing Keying Speed ..... 42
  - Insert Keying ..... 44
  - Messages, Checking ..... 43
  - Messages, Storing ..... 43
  - Messages, Transmitting ..... 43
  - Reverse Keying Weight Ratio ..... 42
- Key Illumination ..... 75
- Lightening protection ..... 1
- Linear Amplifier
  - HF, Connection (REMOTE) ..... 94
  - 50 MHz, VHF, UHF and 1.2 GHz Connection (EXT.CONT) ..... 96
  - Control ..... 76
  - 50 MHz, VHF, UHF and 1.2 GHz ..... 96
- Lithium Battery ..... 99
- Lock All ..... 77
- Lockout, Memory Channels ..... 62
- LSB (see SSB)
- MB-430 ..... 98
- MCP and TNC ..... 95
- Memory
  - Channel Name ..... 63
  - Conventional ..... 58
  - Erasing, Channels ..... 62
  - Group ..... 64
  - Lockout, Channel ..... 62
  - Quick, Recalling Channels ..... 65
  - Quick, Storing into ..... 64
  - Quick, Transfers to VFO ..... 65
  - Recall and Scroll ..... 59
  - Resetting ..... 92
  - Scanning, All-Channel ..... 68
  - Scanning, Group ..... 69
  - Scrolling ..... 59
  - Start/End Frequencies ..... 62
  - Storing the data in ..... 58
  - Transfer, To Memory ..... 61
  - Transfer, To VFOs ..... 61
  - VFO Split Operation ..... 60
- Memory Scan ..... 68
- Menu
  - A/ Menu B ..... 21
  - Access ..... 21
  - Alphabetical Function List ..... 26
  - Configuration ..... 22
  - What is a ..... 21
- Meter ..... 19
- MHz Scan ..... 68
- Microphone
  - Connector (MIC) ..... 3
  - Gain ..... 20, 28, 29
- Mode, Selecting a ..... 19
- Monitor (RX) ..... 77
- Noise Blanker ..... 57
- Normal Scan ..... 66



- Offset  
  Selecting an, Direction ..... 32  
  Selecting an, Frequency ..... 32
- Optional Accessories  
  Available ..... 104  
  Installation ..... 97
- Packet  
  Connection (ACC 2) ..... 95  
  Operation ..... 52
- Packet Cluster Tune ..... 53
- Packet Radio  
  Built-in TNC ..... 49  
  DCD Sense ..... 50  
  Preparation ..... 50
- PacTOR  
  Connection (ACC 2) ..... 95  
  Operation ..... 52
- Partial Reset ..... 92
- PF key ..... 8, 77
- Phones ..... 3, 8, 78
- Pitch, RX Frequency ..... 30
- Power  
  Connecting DC  
    Supply Connection ..... 2  
    Switching ON/OFF ..... 4, 6, 8  
  TX ..... 79
- Pre-amplifier ..... 8, 57
- Program Scan ..... 67  
  Partially Slowed ..... 67
- Programmable  
  keys ..... (See PF key)  
  VFO ..... 62
- Quick Data Transfer  
  Equipment, Compatible ..... 80  
  Equipment, Connection ..... 80  
  Equipment, Needed ..... 80  
  Using ..... 80
- Quick Menu  
  Programming the ..... 21  
  Using the ..... 21
- Quick QSY ..... 37
- Radio Teletypewriting .... (See RTTY)
- RC-2000 ..... 98
- Reverse Function ..... 34
- Repeater Offset, Automatic ..... 34
- Repeater Operation ..... 32
- Reset  
  Full ..... 92  
  Partial ..... 92
- RF Gain ..... 18
- Rise Time of CW ..... 77
- RIT ..... 38
- RTTY  
  Bandwidth ..... 55  
  Connection (RTTY, ACC 2) .... 95  
  Operation ..... 51  
  Tone ..... 51
- RX DSP Equalizer ..... 78
- RX Pitch Frequency ..... 30
- Satellite Operation  
  Basic Operation ..... 53  
  Changing the Frequency Band  
    ..... 54  
  Checking the Uplink  
    Frequency ..... 54  
  Quick Memory in Satellite  
    Mode ..... 54  
  Recalling a Satellite Memory  
    Channel ..... 54  
  Satellite Channel Name ..... 54  
  Storing Satellite Memory  
    Channels ..... 54  
  Using XIT/ RIT in Satellite Mode  
    ..... 54
- Scan  
  All-Channel ..... 68  
  Call ..... 69  
  Carrier-operated mode ..... 68  
  Group ..... 69  
  Hold ..... 68  
  Lockout ..... 62  
  Memory, All-Channel ..... 68  
  Memory, Group ..... 69  
  Program ..... 67  
  Start/End Frequencies ..... 62  
  Time-operated mode ..... 68  
  Visual ..... 70, 103
- Send ..... 5, 7, 8
- Sensitivity ..... 103
- Sidetone  
  Changing, the Volume ..... 44  
  Pitch . (See Pitch, RX Frequency)
- Slow Scan TV ..... (See SSTV)
- Speaker, Separate Output ..... 78
- Specifications ..... 106
- Speech Processor ..... 40
- Split-Frequency Operation ..... 31
- Squelch, Adjusting ..... 19
- Squelch Hang Time ..... 78
- SSB, Transmission ..... 28
- SSTV ..... 52
- Sub-Receiver  
  Activating the ..... 45, 103  
  Adjusting the AF Gain ..... 46  
  Adjusting the Squelch ..... 46  
  Attenuator ..... 47  
  Automatic Simplex Check ..... 48  
  Controlling the ..... 45  
  DCS Code ID Scan ..... 46  
  Dual Watch ..... 47  
  FM CTCSS Operation ..... 46  
  FM DCS Operation ..... 46  
  FM Repeater Operation ..... 47  
  Memory ..... 48  
  Microphone Gain ..... 47  
  Noise Reduction ..... 47  
  Panel Meter ..... 46  
  Pre-amplifier ..... 47  
  Reverse Function ..... 47  
  Scan ..... 47  
  Selecting a Band ..... 45  
  Selecting a Frequency ..... 46  
  Selecting a Mode ..... 46  
  Selecting a Transmit Power ... 47  
  Tone Freq. ID Scan ..... 46  
  Transmitting ..... 47  
  Transmitting a Tone ..... 48
- S-Meter Squelch ..... 78
- TF-SET ..... 31
- TNC Command List, Built-in ..... 110
- Time-operated mode ..... 68
- Time-out Timer ..... 78
- Tone  
  Activating the Function ..... 33  
  Frequency ID Scan ..... 34  
  Selecting a, Frequency ..... 33  
  Selecting Continuous or  
  Burst ..... 33  
  Transmitting a ..... 33  
  Transmitting a 1750 Hz ..... 33
- Transmit Inhibit ..... 41
- Transmit Power, Selecting ..... 20
- Transmitting  
  Changing Frequency while ..... 41  
  Transmission monitor  
    ..... (See TX Monitor)  
  Transmitting ..... 20  
  Transverter ..... 79  
  Troubleshooting ..... 100  
  TS-B2000 Front Panel ..... 109  
  TX Band ..... 45  
  TX Equalizer ..... 41  
  TX Filter Bandwidth ..... 41  
  TX Monitor ..... 79  
  TX Power ..... 79  
  USB (see SSB)
- VFO  
  Equalizing (A=B) ..... 38  
  Programmable ..... 62  
  Scan ..... 66  
  Selecting A/B ..... 18
- Voice Synthesizer (optional)  
  Installation ..... 97  
  Using ..... 91
- Volume  
  AF Gain ..... 18, 46  
  RF Gain ..... 18
- VOX (Voice-Operated Transmit)  
  Delay Time ..... 39  
  Microphone Input Level ..... 39
- VS-3  
  Installation ..... 97  
  Using ..... 91
- XIT ..... 40
- Zero Beat, Auto ..... 30
- 1MHz, Using Steps ..... 37
- 1750 Hz, Transmitting a ..... 33





Hereby, JVCKENWOOD Nederland B.V. declares that the radio equipment types TS-2000, TS-2000X are in compliance with Directive 2014/53/EU.

The full text of the EU declaration of conformity is available at the following internet address:

<http://www.kenwood.com/cs/com/ecdoc/>

(Note: The detail type designations are described in the EU declaration of conformity.)

---

# KENWOOD

CE