

MONITOR WITH DVD RECEIVER

## DDX919WS

## DDX919WSM

## DDX9019DABS

## DDX9019S

## DDX9019SM

MONITOR WITH RECEIVER

## DMX8019DABS

## DMX8019S

### INSTRUCTION MANUAL

JVCKENWOOD Corporation

- Updated information (the latest Instruction Manual, system updates, new functions, etc.) is available from <http://www.kenwood.com/cs/ce/>.

Made for  
 iPhone | iPod

 Works with  
Apple CarPlay

**android**  
**auto**

 Digital  
Radio

 DOLBY AUDIO™

**HDMI**  
HIGH-DEFINITION MULTIMEDIA INTERFACE

 DVD  
VIDEO™

 Bluetooth®

 Wi-Fi  
CERTIFIED



 Spotify™

# Contents

## **Before Use 4**

Precautions.....	4
How to read this manual .....	5

## **Basic Operations 6**

Functions of the Buttons on the Front Panel ...	6
Turning on the Unit .....	8
Initial Settings.....	8
Adjusting the volume .....	11
Display Adjustment .....	11
Viewing Angle .....	12
Touch screen operations .....	12
Gesture Control.....	13
HOME screen descriptions.....	13
Popup menu .....	14
Source selection screen description.....	14
Source control screen descriptions .....	17
List screen .....	18

## **Widget 19**

Widget.....	19
Multi Widget.....	19
Photo Frame Widget .....	21
Widget Setup .....	21

## **Disc 22**

Playing a disc .....	22
DVD/VCD Basic Operation .....	22
Music CD/Disc media Basic Operation .....	24
File search Operation .....	25
DVD Disc Menu Operation.....	26
DVD Setup.....	27

## **APPS 28**

Wireless Mirroring Operation.....	28
Apple CarPlay Operation .....	28
Android Auto™ Operation .....	31
Spotify Operation.....	33

## **USB 35**

Connecting a USB device .....	35
USB Basic Operation.....	35
Search Operation.....	37

## **iPod/iPhone 38**

Preparation .....	38
iPod/iPhone Basic Operation .....	39
Search Operation.....	40

## **Radio 41**

Radio Basic Operation .....	41
Memory Operation .....	42
Selecting Operation .....	42
Traffic Information .....	43
Radio Setup .....	43

## **Digital Radio 44**

Digital Radio Basic Operation .....	44
Storing Service in Preset Memory .....	45
Selecting Operation .....	45
Traffic Information .....	46
Digital Radio Setup.....	47

## **Bluetooth Control 48**

Information for using Bluetooth® devices.....	48
Register the Bluetooth device .....	49
Bluetooth Setup.....	50
Playing the Bluetooth Audio Device .....	52
Using the Hands-Free Unit.....	54
Hands-Free Setup.....	59

## **Other External Components 60**

View Camera .....	60
Use Dashboard Camera.....	63
External audio/video players (AV-IN).....	63
HDMI source.....	63
TV tuner .....	64
Using the external navigation unit .....	64

## **Setup 65**

Monitor Screen Setup.....	65
System Setup .....	65
User Interface Setup.....	66
Special Setup .....	68
Display Setup.....	69
AV Setup .....	71

## **Controlling Audio 73**

3-way speaker system setup .....	73
Speaker / X'over setup .....	74
Controlling General Audio .....	76
Equalizer Control .....	76
Volume Offset .....	77
Zone Control .....	78
Sound Effect .....	79
Listening Position / DTA .....	80
Audio Setup memory .....	81

## **Remote control 82**

Battery Installation.....	82
Functions of the Remote control Buttons .....	82

## **Connection/Installation 85**

Before Installation .....	85
Installing the unit .....	87

## **Troubleshooting 97**

Problems and Solutions .....	97
Error Messages .....	97

## **Appendix 99**

Playable Media and Files.....	99
Region Codes in the World .....	101
DVD Language Codes.....	102
Specifications.....	103
About this Unit .....	106

# Before Use

## Precautions

### ▲ WARNINGS

#### ■ To prevent injury or fire, take the following precautions:

- To prevent a short circuit, never put or leave any metallic objects (such as coins or metallic tools) inside the unit.
- Do not watch or fix your eyes on the unit's display when you are driving for any extended period.
- If you experience problems during installation, consult your KENWOOD dealer.

#### ■ Precautions on using this unit

- When you purchase optional accessories, check with your KENWOOD dealer to make sure that they work with your model and in your area.
- You can select a language to display menus, audio file tags, etc. See **User Interface Setup (P.66)**.
- The Radio Data System or Radio Broadcast Data System feature won't work in areas where the service is not supported by any broadcasting station.

#### ■ Protecting the monitor

- To protect the monitor from damage, do not operate the monitor using a ball point pen or similar tool with a sharp tip.

#### ■ Cleaning the unit

- If the faceplate of this unit is stained, wipe it with a dry soft cloth such as a silicon cloth. If the faceplate is stained badly, wipe it with a cloth moistened with neutral cleaner, then wipe it again with a clean soft dry cloth.

#### NOTE

- Applying spray cleaner directly to the unit may damage its mechanical parts. Wiping the faceplate with a hard cloth or using a volatile liquid such as thinner or alcohol may scratch the surface or erase the screened print.

#### ■ Lens fogging

When you turn on the car heater in cold weather, dew may form on the lens in the disc player of the unit due to condensation. This condensation on the lens (also called lens fogging) may not allow discs to play. In such a situation, remove the disc and wait for the dew to evaporate. If the unit still does not operate normally after a while, consult your KENWOOD dealer.

#### ■ Precautions on handling discs

- Do not touch the recording surface of the disc.
- Do not stick tape etc. on the disc, or use a disc with tape stuck on it.
- Do not use disc type accessories.
- Clean the disc from the center toward the outside rim.
- When removing a disc from this unit, pull it out horizontally.
- If the disc center hole or outside rim has burrs, use the disc only after removing the burrs with a ballpoint pen etc.
- Discs that are not round cannot be used.



- 8-cm (3 inch) discs cannot be used.
- Discs with coloring on the recording surface or discs that are dirty cannot be used.
- This unit can only play the following types of CDs.



- This unit may not correctly play discs which do not have the mark.
- You cannot play a disc that has not been finalized. (For the finalization process, see your writing software and your recorder's instruction manual.)



## Acquiring GPS signal

The first time you turn on this unit, you must wait while the system acquires satellite signals for the first time. This process could take up to several minutes. Make sure your vehicle is outdoors in an open area away from tall buildings and trees for fastest acquisition.

After the system acquires satellites for the first time, it will acquire satellites quickly each time thereafter.

## About GLONASS

This unit uses Global Navigation Satellite System (GLONASS) in addition to GPS.

Combining GPS and GLONASS can refine positioning accuracy than using GPS only.

## Caution for Smartphone Users

Simultaneously running multiple applications on your smartphone while screen sharing places heavy demand on the microprocessor of the phone, potentially affecting communication and performance.

For best results while pairing with your Kenwood receiver, please be sure to close any unused applications.

## How to read this manual

- The screens and panels shown in this manual are examples used to provide a clear explanation of operations. For this reason, they may be different from the actual screens or panels, or some display patterns may be different from the actual ones.
- **Display language:** English is used for the purpose of explanation. You can select a display language from the **SETUP** menu. See **User Interface Setup (P.66)**.

# Basic Operations

## Functions of the Buttons on the Front Panel

DDX919WS / DDX919WSM

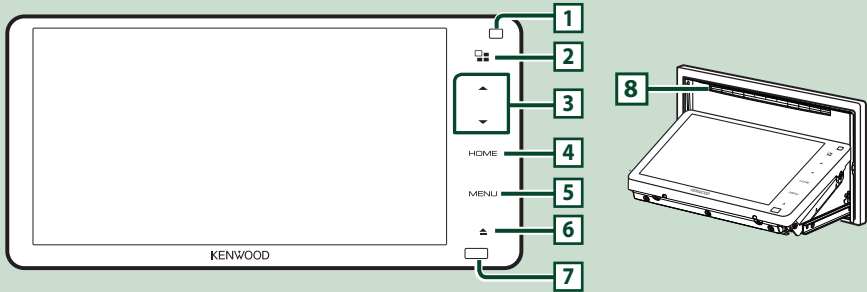

### NOTE

- The panels shown in this manual are examples used to provide clear explanations of the operations. For this reason, they may be different from the actual panels.
  - In this manual, each model name is abbreviated as follows.
    - DDX919WS / DDX919WSM: **WS**
- If above icon is showed, read the article applicable to the unit you use.

Number	Name	Motion
1	Gesture control sensor	• A sensor which detects motions of your hand. (P.13)
2		<ul style="list-style-type: none"> <li>• Displays the APP (Apple CarPlay/Android Auto/Wireless Mirroring) screen.</li> <li>• Pressing and holding displays the Voice Recognition screen (P.56).</li> <li>• When neither Apple CarPlay, Android Auto, nor a Bluetooth Hands-Free phone is connected, pressing and holding displays Bluetooth pairing waiting dialog. (P.49)</li> </ul>
3	▼, ▲ (Volume)	<ul style="list-style-type: none"> <li>• Adjusts volume.</li> <li>• The volume will go up until 15 when you keep pressing ▲. (P.11)</li> </ul>
4	HOME	<ul style="list-style-type: none"> <li>• Displays the HOME screen (P.13).</li> <li>• Pressing for 1 second turns the AV off.* (Touch the display to turn on the screen.)</li> </ul> <p>* Turns off the screen and audio. Interrupts from incoming hands-free calls, rear camera views and so on are functional, though.</p>
5	MENU	• Displays the popup menu screen.
6	▲	<ul style="list-style-type: none"> <li>• Displays the Angle Adjust screen.                             <ul style="list-style-type: none"> <li>– <b>DISC EJECT</b>: Ejects the disc.</li> </ul> </li> <li>• When the panel is opened, closes the panel.</li> <li>• To forcibly eject the disc, press it for 2 seconds and then touch <b>DISC EJECT</b> after the message is displayed.</li> </ul>
7	Remote Sensor	• Receives the remote control signal.
8	Disc insert slot	• A slot to insert a disc media.

## DDX9019DABS / DDX9019S / DDX9019SM

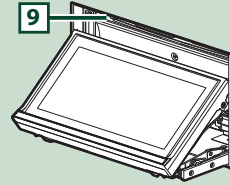
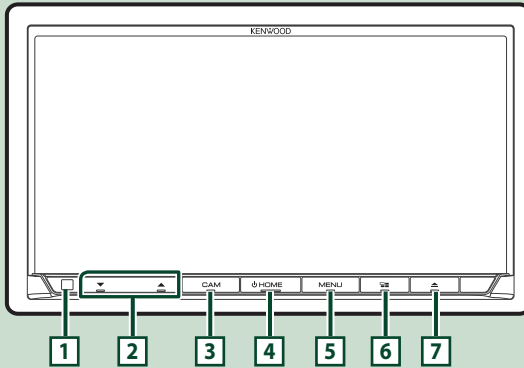

## DMX8019DABS / DMX8019S

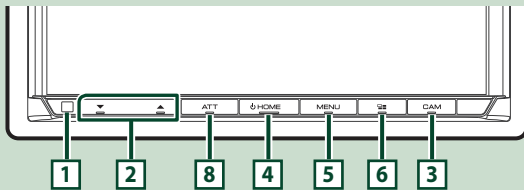

## NOTE

- The panels shown in this manual are examples used to provide a clear explanation of operations. For this reason, they may be different from the actual panels.
  - In this manual, each model name is abbreviated as follows.
    - DDX9019DABS / DDX9019S / DDX9019SM: **9019**
    - DMX8019DABS / DMX8019S: **8019**
- If above icon is showed, read the article applicable to the unit you use.

Number	Name	Motion
1	Remote Sensor	• Receives the remote control signal.
2	▼, ▲ (Volume)	• Adjusts the volume. The volume will go up to 15 when you keep pressing ▲. (P.11)
3	CAM	• Switches view camera display on/off. The camera whose view is displayed first changes according to the "Camera Setup" setting and the shift lever position in the shift gate. • Pressing and holding turns the screen off. ( <b>9019</b> )
4	HOME	• Displays the HOME screen (P.13). • Pressing for 1 second turns the power off. • When the power is off, turns the power on.
5	MENU	• Displays the popup menu screen. • Pressing for 1 second switches attenuation of the volume on/off. ( <b>9019</b> ) • Pressing for 1 second turns the screen off. ( <b>8019</b> )
6		• Displays the APP (Apple CarPlay/Android Auto/Wireless Mirroring) screen. • Pressing and holding displays the Voice Recognition screen (P.56). • When neither Apple CarPlay, Android Auto, nor a Bluetooth Hands-Free phone is connected, pressing and holding displays Bluetooth pairing waiting dialog. (P.49)

Number	Name	Motion
7		<ul style="list-style-type: none"> <li>Displays the Angle Adjust screen.                             <ul style="list-style-type: none"> <li><b>DISC EJECT</b>: Ejects the disc.</li> </ul> </li> <li>When the panel is opened, closes the panel.</li> <li>To forcibly eject the disc, press it for 2 seconds and then touch <b>DISC EJECT</b> after the message is displayed.</li> </ul>
8	ATT	<ul style="list-style-type: none"> <li>Switches attenuation of the volume on/off.</li> </ul>
9	Disc insert slot	<ul style="list-style-type: none"> <li>A slot to insert a disc media. (<b>9019</b>)</li> </ul>

## Turning on the Unit

The method of turning on is different depending on the model.

### WS

#### 1 Touch the display.

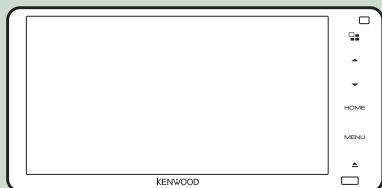

➤ The unit is turned on.

### 9019 8019

#### 1 Press the HOME button.

##### 9019

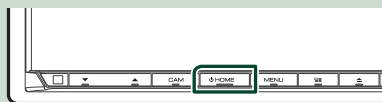

##### 8019

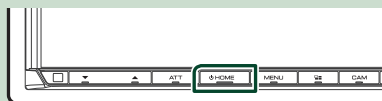

➤ The unit is turned on.

#### ● To turn off the unit:

#### 1 Press the HOME button for 1 second.

#### NOTE

- If it is your first time to turn the unit on after installation, it will be necessary to perform Initial setup (**P.8**).

## Initial Settings

### Initial setup

Perform this setup when you use this unit first time.

#### 1 Set each item as follows.

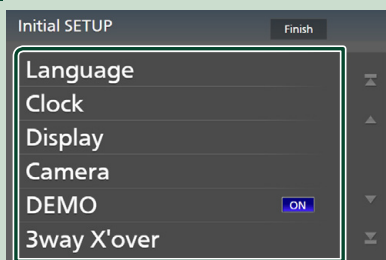

#### ■ Language

Select the language used for the control screen and setting items. Default is "British English(en)".

- Touch **Language**.
- Touch **Language Select**.
- Select the desired language.
- Touch **↵**.

For details, see **User Interface Setup (P.66)**.

#### ■ Clock

Sets the synchronization of the clock and adjusts it.

For details, see **Calendar/clock settings (P.10)**.

#### ■ Display

Set the key illumination color.

If it is hard to see the image on the screen even, adjust the viewing angle.

- Touch **Display**.

- ② Touch **Key Colour**.
- ③ Select the desired color.
- ④ Touch .

(**WS** / **9019** only)

- ⑤ Touch **Display Adjustment**.
- ⑥ Adjust a viewing angle and a tilt position.
- ⑦ Touch .

For details, see **Display Adjustment (P.11)**.

(**8019** only)

- ⑤ Touch **Viewing Angle**.
- ⑥ Select a viewing angle.
- ⑦ Touch .

For details, see **Viewing Angle (P.12)**.

For details, see **Display Setup (P.69)**.

### ■ Camera

Set the parameters for the camera.

- ① Touch **Camera**.
- ② Set each item and touch .

For details, see **Camera Setup (P.60)**.

### ■ DEMO

Set the demonstration mode. Default is "ON".

### ■ 3way X'over

Displays the message screen.

For details, see **(P.73)**.

## 2 Touch Finish.

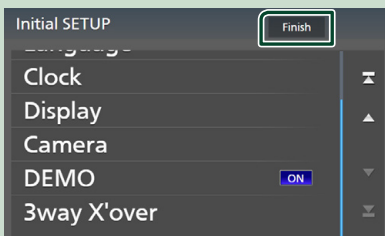

### NOTE

- These settings can be made from the SETUP menu. See **Setup (P.65)**.

## Security Code Setup

You can set up a security code to protect your receiver system against theft.

When the Security Code function is activated, the code cannot be changed and the function cannot be deactivated. Note that the Security Code can be set with a 4 to 8 digit number of your choice.

### Preparation

- Set **DEMO** to **OFF** in the Special screen **(P.68)**.

### 1 Press the **MENU** button.

- Popup menu appears.

### 2 Touch **SETUP**.

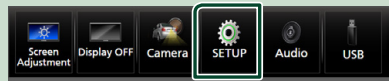

- SETUP Menu screen appears.

### 3 Touch **Security**.



- Security screen appears.

### 4 Touch **Security Code Set** on the Security screen.

- Security Code Set screen appears.

### 5 Enter a security code with 4 to 8 digit number and touch **Enter**.

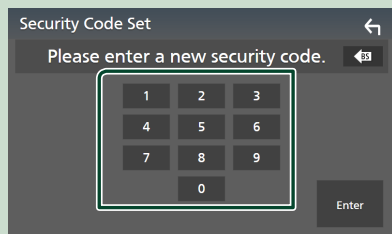

## Basic Operations

- Enter the same code again and touch **Enter**.

Now, your security code is registered.

### NOTE

- Touch **BS** to delete the last entry.
- If you enter a different security code, the procedure returns to step 5 (for first code entry).
- If you have disconnected the Receiver from the battery, enter the correct security code as that you have entered in step 5 and touch **Enter**. You can use your receiver.

### To change the security code:

- Touch **Security Code Change** on the Security screen.
  - Security Code Set screen appears.
- Enter the current registered security code and touch **Enter**.
- Enter a new security code with 4 to 8 digit number and touch **Enter**.
- Enter the same code again and touch **Enter**.

The new security code is registered.

### To clear the security code:

- Touch **Security Code Cancellation** on the Security screen.
  - Security Code Set screen appears.
- Enter the current registered security code and touch **Enter**.

The security code is cleared.

## Calendar/clock settings

- Press the **MENU** button.
  - Popup menu appears.
- Touch **SETUP**.



➤ SETUP Menu screen appears.

- Touch **User Interface**.



➤ User Interface screen appears.

- Set each item as follows.

Scroll the page to show hidden items.

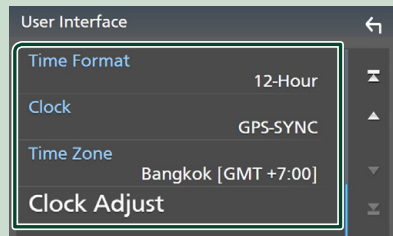

### ■ Time Format

Select the time display format.

**12-Hour** (Default)/**24-Hour**

### ■ Clock

**GPS-SYNC** (Default): Synchronizes the clock time with the GPS.

**Manual**: Set the clock manually.

### ■ Time Zone

If you have selected **Manual** for Clock, select the time zone.

### ■ Clock Adjust

If you select **Manual** for Clock, adjust the date and time manually. (**P.67**)

### NOTE

- Please set the date and time. If they are not set, some functions may not work.

## Adjusting the volume

You can adjust the volume (0 to 40).

Press ▲ to increase, and press ▼ to decrease.

Holding ▲ increases the volume continuously to level 15.

### WS

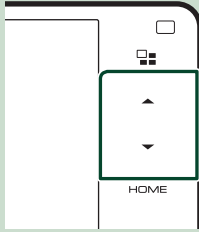

### 9019



### 8019



## Display Adjustment

( WS / 9019 )

- 1 Press the ▲ button.  
➤ Display Adjustment screen appears.
- 2 Select a tilt position you want to set up.  
Default is "0".

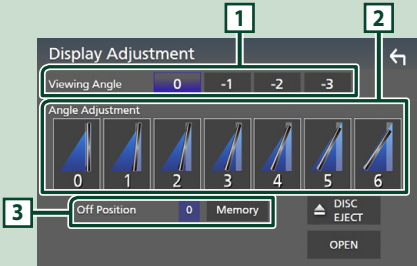

### 1 Viewing Angle

You can adjust the viewing angle when the image on the screen is difficult to see evenly. The smaller the (negative) value, the more whitish the image on the screen looks.

"0" (Default) / "-1" / "-2" / "-3"

### 2 Angle Adjustment

Select a tilt position you want to set up.  
Default is "0".

### 3 Off Position

You can store the current monitor angle as the angle during power off. Touch **Memory** when the desired angle is selected.

## Viewing Angle ( 8019 )

You can adjust the viewing angle when the image on the screen is difficult to see evenly. The smaller the (negative) value, the more whitish the image on the screen looks.

**1** Press the **MENU** button.

➤ Popup menu appears.

**2** Touch **SETUP**.

**3** Touch **Display**.



➤ Display screen appears.

**4** Touch **Viewing Angle**.

**5** Select an angle you want to set up.

Default is "0". (P.69)

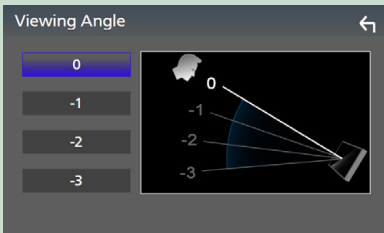

## Touch screen operations

To perform operations on the screen, you need to touch, touch and hold, flick or swipe to select an item, display a setting menu screen or change pages.

● **Touch**

Touch the screen gently to select an item on the screen.

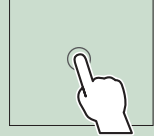

● **Touch and hold**

Touch the screen and keep your finger in place until the display changes or a message is displayed.

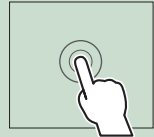

● **Flick**

Slide your finger quickly to the left or right on the screen to change the page. You can scroll a list screen by flicking up/down on the screen.

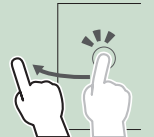

● **Swipe**

Slide your finger up or down on the screen to scroll the screen.





## Gesture Control ( WS )

You can also operate the unit by moving your hand in front of the gesture control sensor.

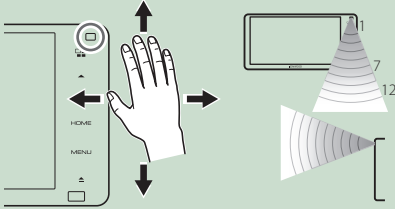

- To control by hand motion, select **ON** for **Gesture Control** on the "User Interface" screen beforehand. (P.66)
- When shipped from the factory, you can operate by moving your hand as follows:
  - To the right: Displays the current source control screen.
  - To the left: Switches to Apple CarPlay/Android Auto screen. (P.28)
  - Up: Displays the Home screen.
  - Down: When a call comes in, answers the call.
- You can assign the functions or sources/ screens to display on the "Gesture SETUP" screen. (P.66)

## HOME screen descriptions

Most functions can be performed from the HOME screen.



- |   |  |
|---|--|
| 1 | <ul style="list-style-type: none"> <li>• Widget (P.19)           <ul style="list-style-type: none"> <li>– You can change the widget by flicking left or right on the widget area.</li> <li>– Touch the widget to display the detailed screen.</li> </ul> </li> </ul> |
| 2 | <ul style="list-style-type: none"> <li>• Displays the source selection screen. (P.15)</li> </ul>   |
| 3 | <ul style="list-style-type: none"> <li>• Short-cut playback source icons (P.15)</li> </ul>   |

## Display the HOME screen

- 1 Press the **HOME** button.

**WS**



**9019**



**8019**



- HOME screen appears.

## Popup menu

- 1 Press the **MENU** button.
  - Popup menu appears.
- 2 Touch to display the popup menu.



The contents of the menu are as follows.

	• Displays the Screen Adjustment screen. <b>(P.65)</b>
	• Turns the display off. <b>(P.14)</b>
	• Displays the view camera screen. <b>(P.60)</b>
	• Displays the SETUP Menu screen. <b>(P.65)</b>
	• Displays the Audio screen. <b>(P.73)</b>
	• Displays the control screen of current source. Icon feature differs depending on the source. This icon is for USB source.
	• Close the popup menu.
<b>1</b>	• Short-cut source icons: The source changes to the one you have set with a short-cut. For the short-cut setting, refer to <b>Customize Short-cut source icons on HOME screen (P.16)</b> .

## Turn off the screen

- 1 Select **Display OFF** on the popup menu.

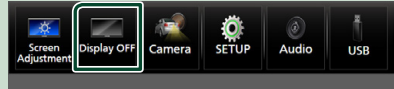

### NOTE

- Touch the display to turn on the screen.
- To display the clock while the screen is off, it is necessary to set "OSD Clock" to "ON". **(P.69)**

## Source selection screen description

You can display icons of all playback sources and options on the source selection screen.



- 1 • Changes playback sources. For playback sources, see **P.15**.
- 2 • Page indication
- 3 • Changes pages. (Touch ) You can also change pages by flicking left or right on the screen.
- 4 • Returns to the previous screen.
- 5 • Displays the SETUP Menu screen. **(P.65)**











## Select the playback source

### 1 Press the **HOME** button.

➤ HOME screen appears.

### 2 Touch .

From the screen, you can select the following sources and functions.

	• Switches to the Apple CarPlay screen from the connected iPhone. <b>(P.28)</b>
	• Switches to the Android Auto screen from the connected Android device. <b>(P.31)</b>
	• Displays the Hands Free screen. <b>(P.54)</b> When neither Apple CarPlay, Android Auto, nor a Bluetooth Hands-Free phone is connected, displays Bluetooth pairing waiting dialog.*1 <b>(P.49)</b>
	• Switches to the Radio broadcast. <b>(P.41)</b>
	• Switches to the Digital Radio broadcast.*2 <b>(P.44)</b>
	• Plays a Bluetooth audio player. <b>(P.48)</b>
	• Plays a disc.*3 <b>(P.22)</b>
	• Plays an iPod/iPhone. <b>(P.38)</b>
	• Plays files on a USB device. <b>(P.35)</b>
	• Switches to Spotify. <b>(P.33)</b>
	• Plays a device connected to the HDMI input terminal. *4 <b>(P.63)</b>
	• Switches to an external component connected to the AV-IN input terminal.*5 <b>(P.63)</b>
	• Switches to the Wireless Mirroring screen from the connected Android device.*4 <b>(P.28)</b>
	• Displays the navigation screen when a navigation unit is connected. <b>(P.64)</b>
	• Displays the Audio screen. <b>(P.73)</b>
	• Puts the unit in standby. <b>(P.16)</b>

\*1 When connecting as Apple CarPlay or Android Auto, it works as a phone provided in Apple CarPlay or Android Auto. If Apple CarPlay or Android Auto are connected during talking by the Bluetooth device or iDataLink phone, the current call will be continued.

\*2 DDX9019DABS / DMX8019DABS only

\*3 **WS** / **9019** only

\*4 Except DMX8019S

\*5 CA-C3AV (optional accessory) is connected to the AV-IN input terminal for visual. **(P.93)**

### To select the playback source on the HOME screen

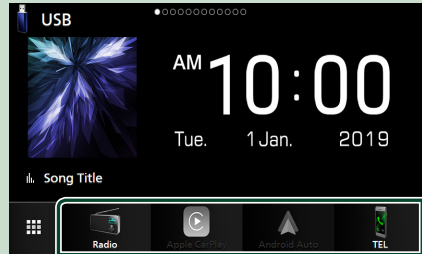

The 4 items displayed on the source selection screen with large icons are shown on the HOME screen.

You can change the items displayed on this area by customizing the source selection screen. **(P.16)**

### To select the playback source on the source control screen

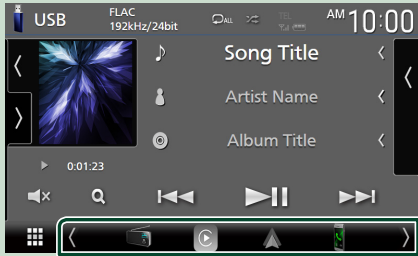

Display source selection icons by touching  or  or flicking left or right on the source control screen, then select a playback source.

### Put the unit in standby

- 1 Press the **HOME** button.  
▶ HOME screen appears.
- 2 Touch .
- 3 Touch **STANDBY**.

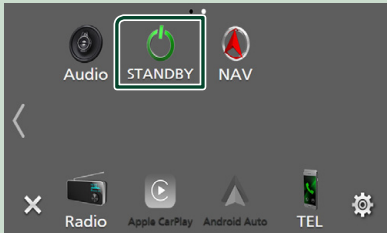

### Customize Short-cut source icons on HOME screen

You can arrange the positions of the source icons as you like.

- 1 Press the **HOME** button.  
▶ HOME screen appears.
- 2 Touch .
- 3 Touch and hold the icon which you want to move in the customizing mode.
- 4 Drag the icon to the desired position.



Changes the page



## Source control screen descriptions

There are some functions which can be performed from most screens.

### Indicators

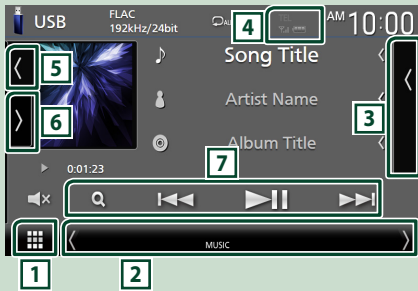

### Short-cut source icons



#### 1 All sources icon

Displays the source selection screen. (P.14)

#### 2 Secondary screen

- : The Secondary screen changes to another one every time you touch it. You can also change the Secondary screen by flicking left or right on the screen.
- Indicators: Displays the current source condition and so on.
  - **ATT**: The attenuator is active.
  - **DUAL**: The dual zone function is active.
  - **MUTE**: The mute function is active.
  - **LOUD**: The loudness control function is active.
- Short-cut source icons: The source changes to the one you have set with a short-cut. For the short-cut setting, refer to **Customize Short-cut source icons on HOME screen (P.16)**.

#### 3 Content list

Displays the track/file/station/channel list.

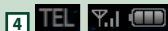

- Connected Bluetooth device information.

#### 5 Artwork & information

You can select whether to display an artwork and song information or only song information in more detail.

Touching the artwork area switches to the VU meter. (The Disc, USB, iPod, Digital Radio, Bluetooth audio sources only)

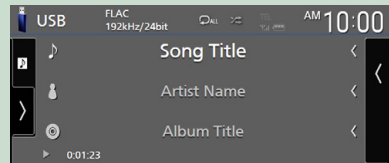
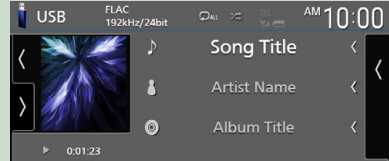

Change the text size of song information when the "Small Audio Text" is set to "ON"/"OFF" in the User Interface screen (P.66).

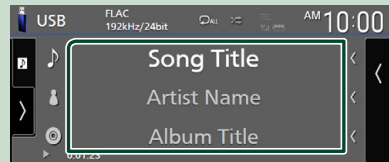
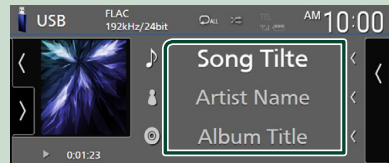

#### 6 Function panel

Touch the left side of the screen to display the function panel. Touch again to close the panel.

#### 7 Operation keys

You can operate the current source with these operation keys. The available functions are different depending on the source type.

## List screen

There are some common function keys in the list screens of most sources.  
See (P.25, 37, 40, 54).

### Display the list screen

#### For Disc media/USB/iPod:

- 1 Touch **Q** or the item listed on the information area in the source control screen.
  - The list screen appears.

#### For Bluetooth audio:

- 1 Touch **Q** .
  - The list screen appears.

You can use following operation keys from this screen.

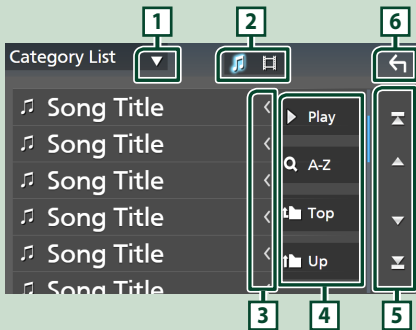

- 1 Displays the list type selection window.

- 2 Displays a music/movie file list.

- 3 **Text scroll**  
Scrolls the displayed text.

- 4 **Play etc.**

Keys with various functions are displayed here.

- **Play**: Plays all tracks in the folder containing the current track.
- **Q A-Z**: Jumps to the letter you entered (alphabetical search).
- **Top** **Up**: Moves to the upper hierarchy level.

- 5 **Page scroll**

You can change pages to display more items by pressing .

- : Displays the top or bottom page.

- 6 **Return**

Returns to the previous screen.

#### NOTE

- Depending on the current source or mode, some function key may not appear.

# Widget

## Widget

- 1 Press the **HOME** button.
- 2 You can change the widget by flicking left or right on the widget area.



### Widget list

- Multi Widget \*
- Clock Widget
- Photo Frame Widget

\* Up to 3 pages can be set to the multi widget screen.

## Multi Widget

You can place a widget on each of the following areas. Up to 4 widgets can be placed per a multi widget screen.

- 1 Press the **HOME** button.
- 2 Flick the widget area to the left/right to display the multi widget.

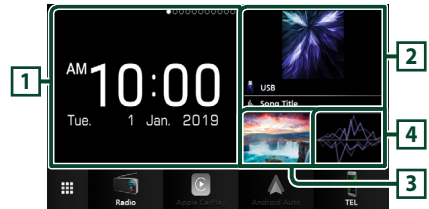

1 Widget (L)

2 Widget (M)

3 Widget (S1)

4 Widget (S2)

### Replace the widget

#### ● To move the widget

- 1 Touch and hold the widget.
  - Widget customize mode is activated.
- 2 Drag the widget to the desired position.

#### ● To delete the widget

- 1 Touch and hold the widget.
  - Widget customize mode is activated.
- 2 Touch **×** on the right top corner of the widget.
  - The selected widget is deleted.

● To replace the widget

1 Touch  on the multi widget screen.

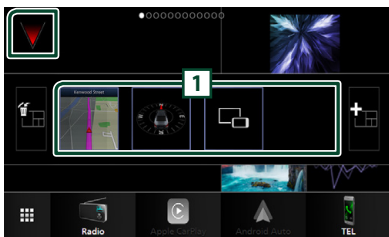

➤ Widget list popup appears.

1 Widget icon

The widgets which can be placed to the multi widget screen are listed.

2 Flick the widget list popup to the left/right to select the widget to replace.

3 Touch and hold the new widget.

➤ Widget customize mode is activated.

4 Drag the widget from the widget list popup to the desired widget area.

You can set up following items.

- Clock Widget
- NAV Widget \*1
- Compass Widget
- Current source information \*2
- Visualizer Widget
- Mirroring Widget \*3 \*4
- Photo Frame Widget



\*1 This can be selected when connecting the external navigation unit. (Except Indonesia models and DMX8019DABS) (P.64)

\*2 You cannot display the screen of Wireless Mirroring on this widget. To display the screen of the source, select the Mirroring Widget.

\*3 This can be selected when using Wireless Mirroring.

\*4 You cannot play the audio/video file on the USB/Disc media when using Wireless Mirroring.

**NOTE**

-  and the widget list popup disappear when no operation is done for 5 seconds.
- When the screen is switched from another widget to multi widget screen,  appears again.

 Add a new multi widget

You can add pages to the multi widget screen.

1 Touch  on the multi widget screen.

➤ Widget list popup appears.



Displays confirmation message to delete the current page from the multi widget screen. For details, see **To delete the multi widget (P.20)**.



Adds a page to the multi widget screen.

2 Touch  on the widget list popup.

➤ A new page is added.

**NOTE**

- You can add up to 2 pages to the multi widget screen. If you have already added 2 pages, you cannot select .
- The widget list popup is displayed on the new page until you place a widget to.

**To delete the multi widget**

1 Touch  on the widget list popup.

➤ Confirmation message appears.

2 Touch **YES**.

➤ Current page is deleted.

**NOTE**

- You cannot delete the first page of the multi widget screen.



## Photo Frame Widget

You can display a slideshow of the image files stored in the USB memory on the Home screen.

### Preparation

- Select "ON" for Photo Frame Widget. See **Widget Setup (P.21)**.

### Acceptable Picture files

	Max. Picture size
JPEG (.jpg, .jpeg) *1	5,000 × 5,000
PNG (.png)	1,000 × 1,000
BMP (.bmp)	1,000 × 1,000

- This unit can only play back files which are less than 50 MB.
- The maximum number of files per device is 500.
- Picture files may not be played depending on their condition.

\*1 A progressive format is not supported.

### Photo Frame

- 1 Press the **HOME** button.
- 2 Flick the widget area to the left/right to display the photo frame widget.

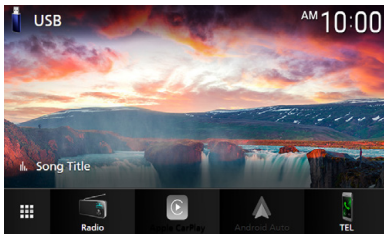

- Scroll the screen to display the hidden part.

## Widget Setup

Set up the widgets on the Home screen.

- 1 Press the **MENU** button.  
➤ Popup menu appears.
- 2 Touch **SETUP**.  
➤ SETUP screen appears.
- 3 Touch **User Interface**.

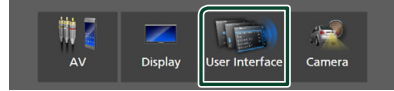

- User Interface screen appears.

- 4 Touch **Widget SETUP** in the User Interface screen.
- 5 Set each item as follows.

#### Photo Frame Widget

Determine whether to use the photo frame widget.

"ON" (Default)/"OFF"

#### Photo Frame SETUP

Make settings related to display of the photo frame widget.

- 6 Touch .

### To Photo Frame Setup

Make settings related to display of the photo frame widget.

- 1 Touch **Photo Frame SETUP** on the **Widget SETUP** screen.

- 2 Set each item as follows.

#### Sort Order

Specify a file sorting criterion.

"By Name(Ascending)"/

"By Name(Descending)"/

"By Date(Newest First)"(Default)/

"By Date(Oldest First)"

#### Slide Show Interval

Specify the slideshow interval.

"5" to "30" seconds.

Default is "5" seconds.

#### Photo Frame is •••••

Display help topics about the photo frame.

- 3 Touch .

# Disc (WS / 9019)

## Playing a disc

### Insert a disc

- 1 Press the **▲** button.

WS

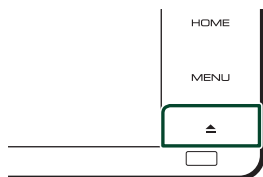

9019



- 2 Touch **DISC EJECT**.

➤ The panel opens.

- 3 Insert the disc into the slot.

WS

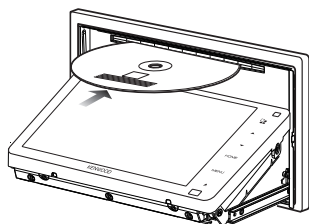

9019

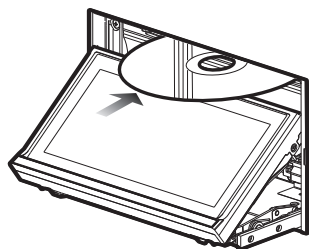

- The panel closes automatically.  
The unit loads the disc and playback starts.

### Eject a disc

- 1 Press the **▲** button.

- 2 Touch **DISC EJECT**.

When removing a disc, pull it horizontally.

- 3 Press the **▲** button.

➤ The panel closes.

#### NOTE

- To forcibly eject the disc, press and hold the **▲** button for 2 seconds and then touch **DISC EJECT** after the message is displayed.

## DVD/VCD Basic Operation

Most functions can be controlled from the source control screen and playback screen.

#### NOTE

- Set the remote control mode switch to DVD mode before starting operation for DVD and VCD, see **Switch the operation mode (P.82)**.
- The screen shot below is for DVD. It may be different from the one for VCD.

- 1 When the operation buttons are not displayed on the screen, touch **7** area.

#### Control screen

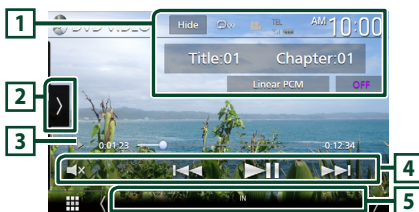



### 1 Information display area

Displays the following information.

- **Title #, Chapter #:** DVD title and chapter number
- **Track #/Scene #:** VCD track or scene number. Scene # is displayed only when Playback control (PBC) is on.
- **Linear PCM, etc.:** Audio format
- **OFF/Zoom2 – 4 (DVD)/Zoom2 (VCD):** Displays the zoom ratio. This function can be used from the remote control. **(P.82)**
- **Hide:** Hides the control screen.
- **⏮**: Repeats the current content. Each time you touch the key, repeat modes are switched in the following sequence;  
**DVD:** Title repeat ( **⏮** ), Chapter repeat ( **⏮** ), Repeat off ( **⏮** )  
**VCD (PBC On):** Does not repeat  
**VCD (PBC Off):** Track repeat ( **⏮** ), Repeat off ( **⏮** )

### 2 Function panel

Touch the left side of the screen to display the function panel. Touch again to close the panel.

- **■**: Stops playback. Touching twice will play the disc from the beginning when you play it next time.
- **⏮ ⏭**: Fast-forwards or fast-backward the disc. Each time you touch the key, the speed changes. 2 times, 10 times.
- **⏪ ⏩** (DVD only): Plays in slow motion forward or backward.
- **SETUP** (DVD only): Touch to display the DVD SETUP screen. See **DVD Setup (P.27)**.
- **MENU CTRL** (DVD only): Touch to display the DVD-VIDEO disc menu control screen. See **DVD Disc Menu Operation (P.26)**.
- **PBC** (VCD only): Touch to turn Playback control (PBC) on or off.
- **Audio** (VCD only): Touch to change audio output channels.

### 3 Play mode indicator/Playing time

- **▶, ▶▶, ■, etc.:** Current play mode indicator. Meanings of the icons are as follows: **▶** (play), **▶▶** (fast forward), **◀◀** (fast backward), **■** (stop), **R** (resume stop), **||** (pause), **I** (slow playback), **◀I** (slow reverse playback).
- For confirmation of current playing position. You can drag the circle left or right to change the playing position.



### 4 Operation keys

- **◀◀ ▶▶**: Searches for the previous/next content. Touch and hold to fast-forward or fast-backward the disc. (It will be cancelled automatically after about 50 seconds.)
- **▶||**: Plays or pauses.
- **⏮ X**: Touch to mute or not to mute.

### 5 Indicator Items

- **IN:** Disc insertion status.  
 White: A Disc is inside the unit.  
 Orange: Disc player failure.

### VCD

- **1chLL/2chLL:** Identifies the left audio output of channel 1 or 2.
- **1chLR/2chLR:** Identifies the monaural audio output of channel 1 or 2.
- **1chRR/2chRR:** Identifies the right audio output of channel 1 or 2.
- **1chST/2chST:** Identifies the stereo audio output of channel 1 or 2.
- **LL:** Identifies the left audio output.
- **LR:** Identifies the monaural audio output.
- **RR:** Identifies the right audio output.
- **ST:** Identifies the stereo audio output.
- **PBC:** The PBC function is on.
- **VER1:** The VCD version is 1.
- **VER2:** The VCD version is 2.

### 6 Searching area

Touch to search for the next/previous content.

### 7 Key display area

Touch to display the control screen.

### 8 MENU CTRL (DVD only)

Touch to display the DVD-VIDEO disc menu control screen. See **DVD Disc Menu Operation (P.26)**.

**NOTE**

- The control screen disappears when no operation is done for 5 seconds.
- If you use a remote control, you can jump directly to the desired image by entering the chapter number, scene number, play time, etc. (P.82).

## Music CD/Disc media Basic Operation

Most functions can be controlled from the source control screen and playback screen.

**NOTE**

- Set the remote controller mode switch to AUD mode before starting operation for Music CD and audio files, see **Switch the operation mode (P.82)**.
- In this manual, "Music CD" means a general CD which includes music tracks. "Disc media" means a CD/DVD disc which includes audio or video files.
- The screen shot below is for disc media. It may be different from the one for CD.

**Control screen**

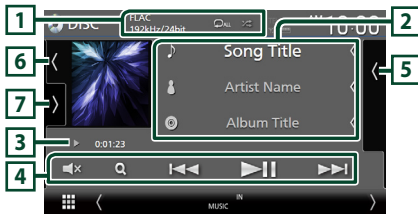

**Open the drawer**

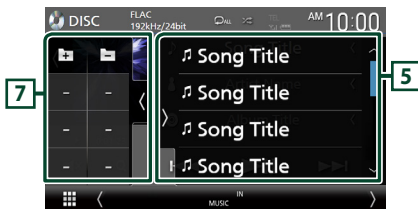

**Close the drawer**

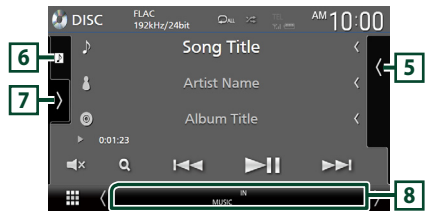

**1 CODEC/ [ ] / [ ]**

- When a high-resolution source is played, its format information is displayed. (Disc media only)
- [ ] : Repeats the current track/folder. Each time you touch the key, repeat mode switches in the following sequence; Track/File repeat ( [ ] ), Folder repeat ( [ ] ) (Disc media only), Repeat all ( [ ] )
- [ ] : Randomly plays all tracks in current folder/disc. Each time you touch the key, random mode switches in the following sequence; Track random ( [ ] ) (Music CD only), Folder random ( [ ] ) (Disc media only), Random off ( [ ] )

**2 Track information**

- Displays the information of the current track/file. Only a file name and a folder name are displayed if there is no tag information. (Disc media only)
- Change the text size of song information when the "Small Audio Text" is set to "ON"/"OFF" in the User Interface screen (P.66).

**3 Play mode indicator/Playing time**

- [ ] , [ ] , etc.: Current play mode indicator. Meanings of the icons are as follows: [ ] (play), [ ] (fast forward), [ ] (fast backward), [ ] (pause).
- For confirmation of current playing position. You can drag the circle left or right to change the playing position. (Video file only)



**4 Operation keys**

- [ ] (Disc media only) : Searches files. For details on search operation, see **File search Operation (P.25)**.
- [ ] [ ] : Searches for the previous/next content.

Touch and hold to fast-forward or fast-backward the disc. (It will be cancelled automatically after about 50 seconds.)

- ▶ || : Plays or pauses.
- ⏏ : Touch to mute or not to mute.

### 5 Content list

- Touch the right side of the screen to display the Content list. Touch again to close the list.
- Displays the playing list. When you touch a track/file name on the list, playback will start.

### 6 Artwork/VU meter

- Displays/hides artwork area.
- The jacket of the currently playing file is displayed. (Disc media only)
- Touch to switch between the artwork and VU meter.

### 7 Function panel (Disc media only)

Touch the left side of the screen to display the function panel. Touch again to close the panel.

- ◀ ▶ : Searches for the previous/next folder.

### 8 Indicator Items

- **IN** : Disc insertion status.  
White: A Disc is inside the unit.  
Orange: Disc player failure.
- **VIDEO** : Identifies the video file.
- **MUSIC** : Identifies the music file.

### Video screen



### 9 File search area (Video file only)

Touch to search for the next/previous file.

### 10 Key display area (Video file only)

Touch to display the control screen.

## File search Operation (Disc media only)

You can search for a file according to hierarchy.

### NOTE

- For operations in the list screen, see **List screen (P.18)**.

### 1 Touch Q.

- ▶ Folder List screen appears.

### 2 Touch the desired folder.

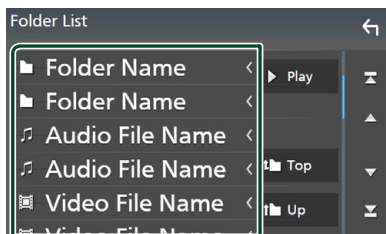

- ▶ When you touch a folder its contents are displayed.

### 3 Touch the desired item in the content list.

- ▶ Playback starts.

## DVD Disc Menu Operation

You can set up some functions using the DVD-VIDEO disc menu.

### 1 Touch the framed area during playback.



➤ Menu Control screen appears.

### 2 Perform your desired operation as follows.

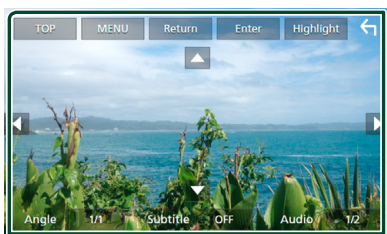

#### ■ To display the top menu

Touch **TOP**.\*

#### ■ To display the menu

Touch **MENU**.\*

#### ■ To display the previous menu

Touch **Return**.\*

#### ■ To enter selected item

Touch **Enter**.

#### ■ To enable direct operation

Touch **Highlight** to enter the highlight control mode (*P.26*).

#### ■ To move the cursor

Touch ▲, ▼, ◀, ▶.

#### ■ To switch among subtitle languages

Touch **Subtitle**. Each time you touch this key, subtitle languages are switched.

#### ■ To switch among audio languages

Touch **Audio**. Each time you touch this key, audio languages are switched.

#### ■ To switch among picture angles

Touch **Angle**. Each time you touch this key, picture angles are switched.

\*These keys may not function depending on the disc.

## Highlight control

Highlight control lets you control the DVD menu by touching the menu key directly on the screen.

### 1 Touch **Highlight** on the Menu Control screen.

### 2 Touch your desired item on the screen.



#### NOTE

- The highlight control function is cancelled automatically if you do not operate for a predetermined period of time.

## DVD Setup

You can set up the DVD playback functions.

### 1 Touch the framed area during playback.

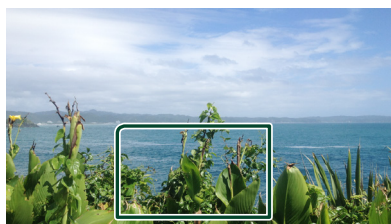

### 2 Touch on the left side of the screen. Touch **SETUP**.



► DVD SETUP screen appears.

### 3 Set each function as follows.

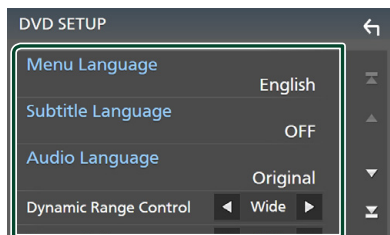

#### ■ **Menu Language / Subtitle Language / Audio Language**

See **Language setup (P.27)**.

#### ■ **Dynamic Range Control**

Sets the dynamic range.

**Wide**: The dynamic range is wide.

**Normal**: The dynamic range is normal.

**Dialog** (Default): Makes the total sound volume larger than the volumes in other modes. This is effective only when the Dolby Digital software is in use.

#### ■ **Screen Ratio**

Sets the screen display mode.

**16:9** (Default): Displays wide pictures.

**4:3 LB**: Displays wide pictures in the Letter Box format (having black stripes at the top and bottom of screen).

**4:3 PS**: Displays wide pictures in the Pan & Scan format (showing pictures cut at the right and left ends).

#### **Language setup**

This setting is for the languages used for the menu, subtitle, and voice.

### 1 Touch the desired item; **Menu Language**, **Subtitle Language**, **Audio Language**.

► Language Set screen appears.

### 2 Select a language.

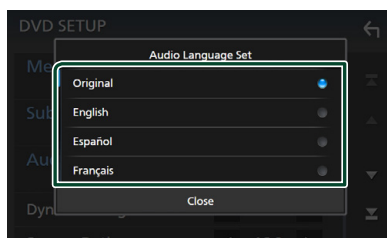

For language codes, refer to **DVD Language Codes (P.102)**.

Touch Close to set the entered language and return to the DVD SETUP screen.

#### **NOTE**

- To set the DVD's original language as the audio language, touch **Original**.

# APPS

## Wireless Mirroring Operation (Except DMX8019S)

You can display the same screen of the Android device on the monitor of the unit using the Wireless Mirroring function of the Android device.

### Preparation

- You can use the Wireless Mirroring function with Android devices compatible with this function.
- This function may be called Wireless Display, Screen Mirroring, AllShare Cast, etc., depending on the manufacturer.
- The settings on the Android device differ depending on the device type. For details, refer to the instruction manual supplied with your Android device.
- If your Android device is locked, Mirroring screen may not appear.
- If the Android device is not ready for UIBC, you cannot perform touch operation.

- 1 Press the **HOME** button.
- 2 Touch .
- 3 Touch **Wireless Mirroring**. (P.15)
  - ▶ The App screen is displayed.
- 4 Operate your Android device to activate the **Wireless Mirroring** function, then connect to this unit.
- 5 Select ("DDX\*\*\*\*"/"DMX\*\*\*\*") as the network to use.
  - ▶ When the connection is established, then the same screen displayed on the Android device is displayed.

### NOTE

- Apps is discontinued when the power is turned ON/OFF or you leave the vehicle. To restart Apps, operate the Android device.
- When the Apps source is displayed, you cannot register or reconnect a Bluetooth device. Switch the Apps source to another source, and then operate the Bluetooth device.

## Apple CarPlay Operation

Apple CarPlay is a smarter, safer way to use your iPhone in the car. Apple CarPlay takes the things you want to do with iPhone while driving and displays them on the screen of the product. You can get directions, make calls, send and receive messages, and listen to the music from iPhone while driving. You can also use Siri voice control to make it easier to operate iPhone.

For details about Apple CarPlay, visit <https://apple.com/ios/carplay/>.

### Compatible iPhone devices

You can use Apple CarPlay with the following iPhone models.

- iPhone X
- iPhone 8 Plus
- iPhone 8
- iPhone 7 Plus
- iPhone 7
- iPhone SE
- iPhone 6s Plus
- iPhone 6s
- iPhone 6 Plus
- iPhone 6
- iPhone 5s
- iPhone 5c
- iPhone 5

## Connecting an iPhone

### Wired connection

- 1 Connect your iPhone using KCA-iP103 via the **USB (Black)** terminal. (P.95)

When an iPhone compatible with Apple CarPlay is connected to the USB (Black) terminal, the Bluetooth Hands-Free phone currently connected is disconnected. If the Bluetooth Hands-Free phone is being used, disconnection will occur after ending the call.

- 2 **Unlock your iPhone.**



## Wireless connection (Except DMX8019S)

You can select the iPhone registered as the Bluetooth device from **Apple CarPlay Device List** and use it as the Apple CarPlay device.

### Preparation

- To register an iPhone by the connection via the USB (Black) terminal
  - Connect an iPhone via the USB (Black) terminal and operate the iPhone according to the confirmation messages displayed on the iPhone. The iPhone is registered in **Apple CarPlay Device List**. Removing the iPhone from the USB (Black) terminal and selecting the registered iPhone from **Apple CarPlay Device List**, the iPhone will be connected wirelessly.
- To register an iPhone by the connection via Bluetooth
  - Touching  on the **Apple CarPlay Device List** screen (P.29), displays Bluetooth pairing waiting dialog. Referring to **Register the Bluetooth device (P.49)** and registering the iPhone, the iPhone will be connected wirelessly.

- Press the **HOME** button.
- Touch .
- Touch **Apple CarPlay**. (P.15)

### NOTE

- Turn on the Bluetooth function and Wi-Fi function of an iPhone.
- If two or more iPhones have been registered, select the iPhone to be used as the **Apple CarPlay** source. (P.29)
- You can also select the iPhone registered in **Apple CarPlay Device List (P.29)** even when the **Apple CarPlay** icon is not activated on the source selection screen.
- It is necessary to connect the GPS antenna and the speed pulse input in order to use a wireless Apple CarPlay.

## To switch the Current Screen to the Apple CarPlay Screen When Connecting Your iPhone

- Touch **Apple CarPlay** icon on the source selection screen. (P.15)
- Touch the following connection message if the message appears.



### NOTE

- The connection message appears when;
  - The iPhone you used previously is connected again.
  - The screen other than HOME and the source selection screen is displayed.
- The connection message is displayed for about 5 seconds.

## Select an Apple CarPlay device (Except DMX8019S)

If two or more iPhones compatible with Apple CarPlay have been registered, select the iPhone to be used as the Apple CarPlay source.

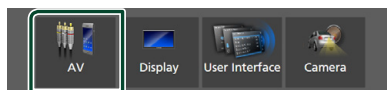

- Press the **MENU** button.
  - Pop-up menu appears.
- Touch **SETUP**.
  - SETUP screen appears.
- Touch **AV**.

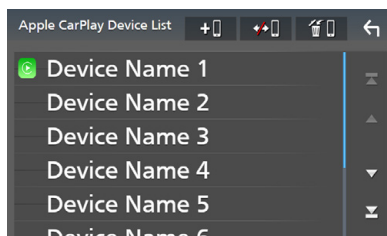

- Touch **Apple CarPlay Device List**.
- Select a device.

The Apple CarPlay device connected via the USB and the registered Apple CarPlay devices ready for wireless connection are displayed.



-  : Displays a Bluetooth pairing waiting dialog. For details, see **Register the Bluetooth device (P.49)**.
-  : Displays confirmation message to disconnect the device.
-  : Displays Device Remove screen. (P.30)

**To delete the registered Apple CarPlay device**

1 Touch .

2 Touch the device name to check.

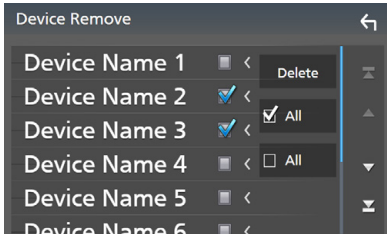

- **ALL**  
Selects all Apple CarPlay devices.
- **ALL**  
Clears all check marks.

3 Touch **Delete**.

➤ Confirmation message appears.

4 Touch **Yes**.

➤ All the selected device(s) is deleted.

**NOTE**

• This operation also deletes the same device(s) from the Bluetooth device list screen. **(P.51)**

**Operation buttons and available Apps on the home screen of Apple CarPlay**

You can use the Apps of the connected iPhone. The items displayed and the language used on the screen differ among the connected devices.

To enter the Apple CarPlay mode, touch **Apple CarPlay** icon on the source selection screen. **(P.15)**

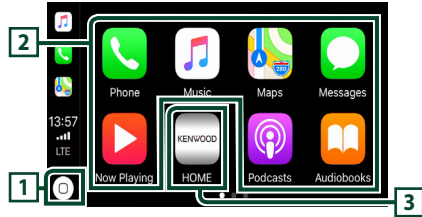

1 

- Displays the home screen of Apple CarPlay.
- Touch and hold to activate Siri.

**2 Application buttons**

Starts the application.

**3 HOME**

Exits the Apple CarPlay screen and displays the Home screen.

**To exit the Apple CarPlay screen**

1 Press the **HOME** button.

**Use Siri**

You can activate Siri.

1 Press the  button for 1 second.

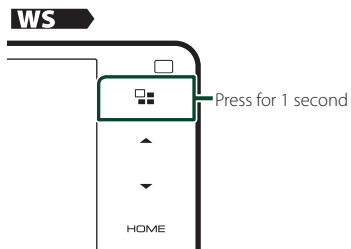

**9019**

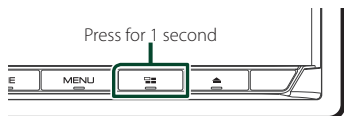

**8019**

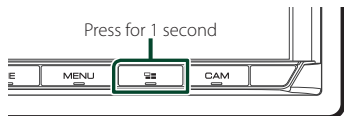

**2** Talk to Siri.

**To deactivate**

**1** Press the button.

**Switch to the Apple CarPlay screen while listening to another source**

**1** Press the button.

**WS**

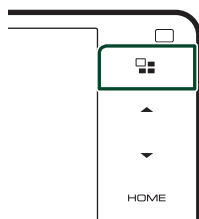

**9019**

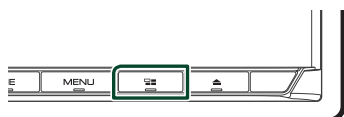

**8019**



**NOTE**

- When listening to another source with the Apple CarPlay screen displayed, playing music in the Apple CarPlay mode will switch the current source to the Apple CarPlay source.

**Android Auto™ Operation**

Android Auto enables you to use the functions of your Android device convenient for driving. You can easily access route guidance, make calls, listen to music, and access convenient functions on the Android device while driving. For details about Android Auto, visit <https://www.android.com/auto/> and <https://support.google.com/androidauto>.

**Compatible Android devices**

You can use Android Auto with Android devices of Android version 5.0 (Lollipop) or later.

**NOTE**

- Android Auto may not be available on all devices and may not be available in all countries or regions.

**● About the placement of smartphone**

Install the smartphone connected as Android Auto device in the place where it can receive the GPS signals.

When using Google Assistant, install the smartphone in the place where the smartphone easily catch a voice by the microphone.

**NOTE**

- Do not put the smartphone in a spot exposed to direct sunlight or near an air blowing out port of an air conditioner. The placement of the smartphone in such places can lead to malfunction or damage of your smartphone.
- Do not leave the smartphone in the vehicle.

## Connect Android device

- 1 **Connect an Android device via the USB terminal. (P.95)**  
 To use the hands-free function, connect the Android device via Bluetooth.  
 When an Android device compatible with Android Auto is connected to the USB terminal, the device is connected via Bluetooth automatically, and the Bluetooth Hands-Free phone currently connected is disconnected.
- 2 **Unlock your Android device.**
- 3 **Press the HOME button.**
- 4 **Touch .**
- 5 **Touch Android Auto. (P.15)**

## Operation buttons and available Apps on the Android Auto screen

You can perform the operations of the Apps of the connected Android device.  
 The items displayed on the screen differ among the connected Android devices.  
 To enter the Android Auto mode, touch the **Android Auto** icon on the source selection screen. (P.15)

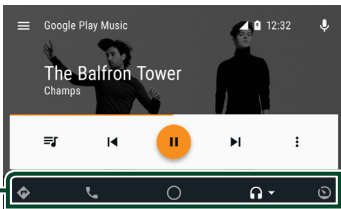

### 1 Application/information buttons

Starts the application or displays information.

### To exit the Android Auto screen

- 1 **Press the HOME button.**

## Using voice control

- 1 **Press the  button for 1 second.**

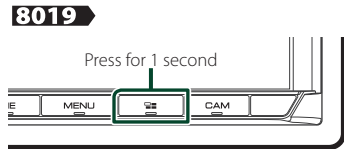
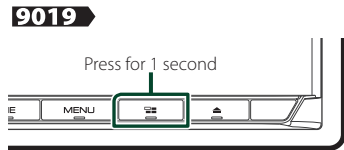
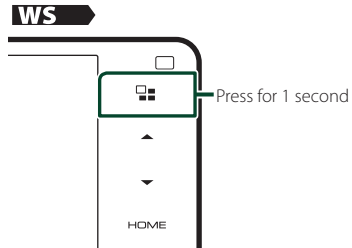

### To cancel

- 1 **Press the  button.**

## Switch to the Android Auto screen while listening to another source

1 Press the  button.

**WS**

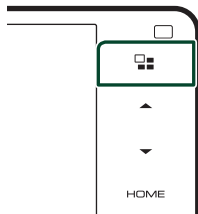

**9019**

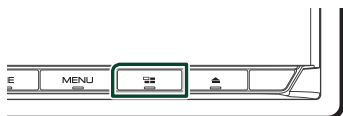

**8019**

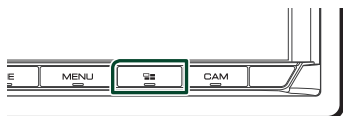

### NOTE

- When listening to another source with the Android Auto screen displayed, playing music in the Android Auto mode will switch the current source to the Android Auto source.

## Spotify Operation

You can listen to Spotify on this unit by controlling the application installed in the iPhone or Android.

To select the Spotify source, touch **Spotify** icon on the source selection screen. (P.15)

### Preparation

- Install the latest version of the Spotify application "Spotify" on your iPhone or Android.
- iPhone:** Search for "Spotify" in the Apple App Store to find and install the most current version.
- Android:** Search for "Spotify" in Google play to find and install the most current version.
- iPhones are connected via either USB or Bluetooth.
- Android devices are connected via Bluetooth.
- To connect a smartphone via Bluetooth, register it as the Bluetooth device and do the App (SPP) profile setting for the connection beforehand. See **Register the Bluetooth device (P.49)** and **Connect the Bluetooth device (P.50)**.
- When an Apple CarPlay is connected, you can use Spotify.

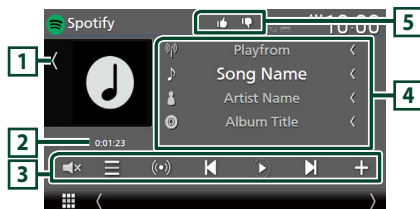

### Close the drawer

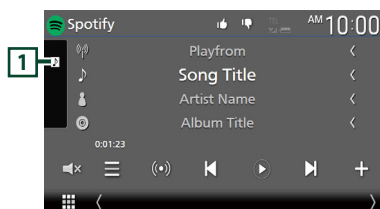









### 1 Artwork

- Displays/hides artwork area.
- Picture data is displayed if available from the current content.

### 2 Playing time

- For confirmation of play time.





### 3 Operation keys

-  : Displays the Station list screen.
-  : New radio station that relates to the artist of the currently being played song is selected and playback starts.
-  ,  : Skips the current song. (Note that this function is disabled when the Spotify skip limitation is exceeded.)
-  ,  : Plays or pauses the content of the current station.
-  : Saves the currently being played song to My Music.
-  : Touch to mute or not to mute.

### 4 Content information

- Displays the information on the current content being played.
- Change the text size of song information when the "Small Audio Text" is set to "ON"/"OFF" in the User Interface screen (P.66).

### 5 / / /

-  : Thumbs down to the current contents and skips to the next content.
-  : Registers the current content as a favorite content.
-  : Repeats the current song.
-  : Randomly plays all songs in the current playlist.

## Selecting a track

### 1 Touch .

> Station list screen appears.

### 2 Select the list type, then select a desired item.

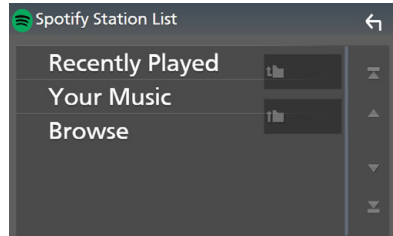

#### To select the category and station

Touch the category and station name in the list.

#### Top

Returns to the top of the list.

#### Up

Returns to the previous list.

### About Spotify®

#### Note

- Ensure you are logged in to your smartphone application. If you do not have an Spotify account, you can create one for free from your smartphone or at [www.spotify.com](http://www.spotify.com).
- Because Spotify is a third-party service, the specifications are subject to change without prior notice. Accordingly, compatibility may be impaired or some or all of the services may become unavailable.
- Some functions of Spotify cannot be operated from this unit.
- For issues on using the application, contact Spotify at [www.spotify.com](http://www.spotify.com).
- Establish an Internet connection.

# USB

## Connecting a USB device

- 1 Connect the USB device with the USB cable. (P.94)

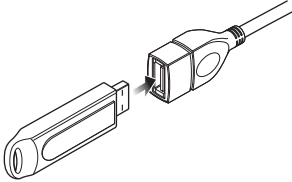

- 2 Press the **HOME** button.
- 3 Touch .
- 4 Touch **USB**. (P.15)

### Disconnect the USB device

- 1 Press the **HOME** button.
- 2 Touch a source other than **USB**.
- 3 Detach the USB device.

### Usable USB device

You can use a mass-storage-class USB device with this unit.

The word "USB device" appearing in this manual indicates a flash memory device.

#### ● About the file system

The file system should be the one of the following.

- FAT16
- FAT32
- exFAT
- NTFS

#### NOTE

- Install the USB device in the place where it will not affect safe driving.
- You cannot connect a USB device via a USB hub and Multi Card Reader.
- Take backups of the audio files used with this unit. The files can be erased depending on the operating conditions of the USB device. We shall have no compensation for any damage arising from any erased data.

## USB Basic Operation

Most functions can be controlled from the source control screen and playback screen.

#### NOTE

- Set the remote controller mode switch to AUD mode before starting operation, see **Switch the operation mode (P.82)**.

#### Control screen

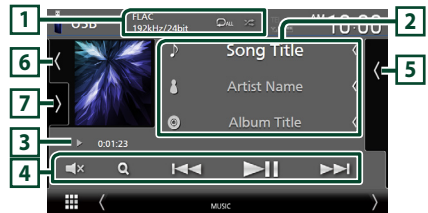



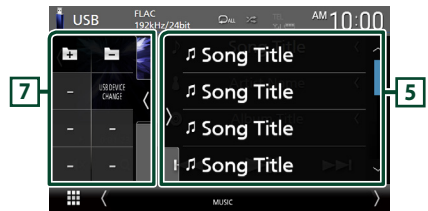

#### Open the drawer

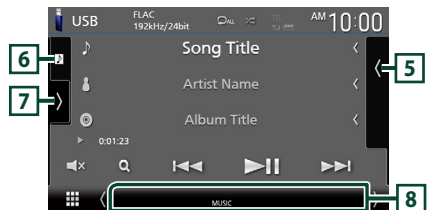



#### Close the drawer



#### 1 CODEC/ / /







- When a high-resolution source is played, its format information is displayed.
-  : Repeats the current track/folder. Each time you touch the key, repeat modes are switched in the following sequence: File repeat () , Folder repeat () , Repeat all ()

-  : Randomly plays all tracks in the current folder. Each time you touch the key, random modes are switched in the following sequence: File random (  ), Random off (  )

**2 Track information**





- Displays the information on the current file. Only a file name and a folder name are displayed if there is no tag information.
- Change the text size of song information when the "Small Audio Text" is set to "ON"/"OFF" in the User Interface screen (P.66).

**3 Play mode indicator/Playing time**

- , , etc.: Current play mode indicator. Meanings of individual icons are as follows:  (play),  (fast forward),  (fast backward),  (pause).
- For confirmation of current playing position. You can drag the circle left or right to change the playing position. (Video file only)



**4 Operation keys**

-  : Searches track/file. For details on search operation, see **Search Operation (P.37)**.
- ,  : Searches the previous/next track/file. Touch and hold to fast forward or fast backward. (It will be cancelled automatically after about 50 seconds.)
-  : Plays or pauses.
-  : Touch to mute or not to mute.

**5 Content list**



- Touch the right side of the screen to display the Content list. Touch again to close the list.
- Displays the playing list. When you touch a track/file name on the list, playback will start.

**6 Artwork/VU meter**

- Displays/hides artwork area.
- The jacket of the currently playing file is displayed.
- Touch to switch between the artwork and VU meter.

**7 Function panel**

Touch the left side of the screen to display the function panel. Touch again to close the panel.

- ,  : Searches for the previous/next folder.

**USB DEVICE CHANGE:**

- Switches to another USB device when two USB devices are connected.

**8 Indicator Items**

- **VIDEO:** Identifies the video file.
- **MUSIC:** Identifies the music file.

Video screen



**9 File search area (Video file only)**

Touch to search for the next/previous file.

**10 Key display area (Video file only)**

Touch to display the control screen.



## Search Operation

You can search music or video files by the following operations.

- 1 Touch **Q**.
- 2 Touch **▼**.



- 3 Select a list type.

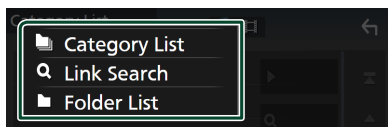



### NOTE

- For operations on the list screen, see *List screen (P.18)*.

## Category search

You can search for a file by selecting a category.

- 1 Touch **Category List**.
- 2 Select whether you search audio files  or video files .
- 3 Touch the desired category.

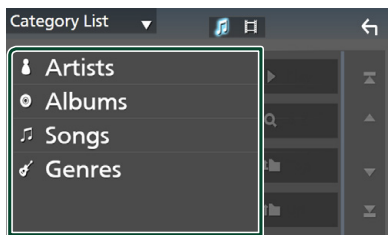

- The list corresponding to your selection appears.

- 4 Touch to select the desired item in the list. Repeat this step until you find the desired file.

## Link search

You can search for a file of the same artist/album/genre as that in the current track.

- 1 Touch **Link Search**.
- 2 Touch the desired tag type. You can select from artists, albums and genres.

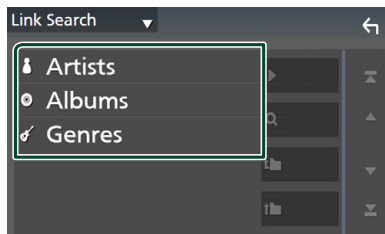

- The list corresponding to your selection appears.

- 3 Touch the desired item in the content list.

## Folder search

You can search for a file according to hierarchy.

- 1 Touch **Folder List**.
- 2 Touch the desired folder.

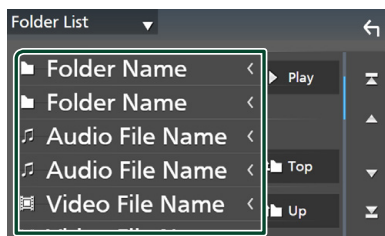

When you touch a folder its contents are displayed.

- 3 Touch to select your desired item in the list. Repeat this step until you find the desired file.

# iPod/iPhone

## Preparation

### Connectable iPod/iPhone

The following models can be connected to this unit.

Made for

- iPhone X
- iPhone 8 Plus
- iPhone 8
- iPhone 7 Plus
- iPhone 7
- iPhone SE
- iPhone 6s Plus
- iPhone 6s
- iPhone 6 Plus
- iPhone 6
- iPhone 5s
- iPhone 5c
- iPhone 5
- iPod touch (6th generation)

#### NOTE

- Latest compatible list of iPod/iPhone. For details, see [www.kenwood.com/cs/ce/ipod/](http://www.kenwood.com/cs/ce/ipod/).
- By connecting your iPod/iPhone to this unit with the iPod connection cable KCA-iP103 (optional accessory), you can supply power to your iPod/iPhone as well as charge it while playing music. Note that the power of this unit must be held on.
- If you restart playback after connecting the iPod, the music that has been played by the iPod is played first.

### Connect iPod/iPhone

#### Wired connection

##### Preparation

- Connect an iPod/iPhone with the KCA-iP103 (optional accessory) while Apple CarPlay is not connected.
- With an Apple CarPlay-capable iPhone, turn off Apple CarPlay by operating the iPhone at functional setup before connecting iPhone. For details of the setup method, contact the manufacturer of the terminal.
- Plug the iPod/iPhone into the gray USB terminal with the KCA-iP103 (optional accessory).
- Only one iPod/iPhone can be connected.

- 1 Connect the iPod/iPhone using the KCA-iP103. (P.95)
- 2 Press the **HOME** button.
- 3 Touch .
- 4 Touch **iPod**. (P.15)

#### ● To disconnect the iPod/iPhone connected with the cable:

- 1 Detach the iPod/iPhone.

#### Bluetooth connection

Pair the iPhone through Bluetooth.

##### Preparation

- To connect an iPhone via Bluetooth, register it as a Bluetooth device and do the profile setting for the connection beforehand. See **Register the Bluetooth device (P.49)** and **Connect the Bluetooth device (P.50)**.
- Connect an iPhone via Bluetooth while Apple CarPlay and an iPod/iPhone are not connected via USB.
- With an Apple CarPlay-capable iPhone, turn off Apple CarPlay by operating the iPhone at functional setup before connecting iPhone. For details of the setup method, contact the manufacturer of the terminal.

#### ● Select the method of making connections for outputting sound from the iPod source (Except DMX8019S)

- 1 Press the **MENU** button.
  - Pop-up menu appears.
- 2 Touch **SETUP**.
  - SETUP screen appears.
- 3 Touch **AV**.
  - AV screen appears.
- 4 Touch **iPod Bluetooth Connection**.
  - Bluetooth** (Default): Output sound using a Bluetooth device.
  - Bluetooth+HDMI**: Output sound using an HDMI device and perform music selection, etc. using a Bluetooth device.

## iPod/iPhone Basic Operation

### NOTE

- Set the remote controller mode switch to AUD mode before starting operation, see **Switch the operation mode (P.82)**.

### Control screen

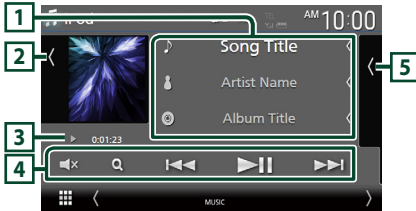

### Open the drawer

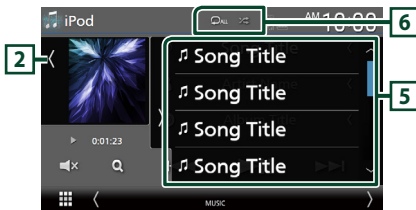

### Close the drawer

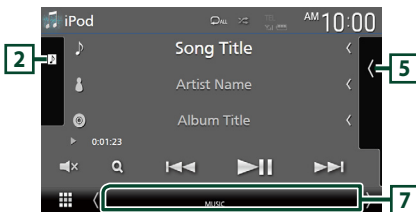

### 1 Track information

- Displays the information on the current file.
- Touch to display the category list screen. See **Category search (P.40)**.
- Change the text size of song information when the "Small Audio Text" is set to "ON"/"OFF" in the User Interface screen (P.66).

### 2 Artwork/VU meter

- Displays/hides artwork area.
- The jacket of the currently being played file is displayed.
- Touch to switch between the artwork and VU meter.

### 3 Play mode indicator/Playing time

- ▶, ▶▶, etc.: Current play mode indicator  
Meanings of individual icons are as follows:  
▶ (play), ▶▶ (fast forward), ◀◀ (fast backward), || (pause).

### 4 Operation keys

- 🔍 : Searches for a track/file. For details on search operation, see **Search Operation (P.40)**.
- ◀◀ ▶▶ : Searches for the previous/next track/file.  
Touch and hold to fast forward or fast backward. (It will be cancelled automatically after about 50 seconds.)
- ▶|| : Plays or pauses.
- 🔊 : Touch to mute or not to mute.

### 5 Content list

- Touch the right side of the screen to display the Content list. Touch again to close the list.
- Displays the playing list. When you touch a track/file name on the list, playback will start.

### 6 Repeat/Random

- 🔄 : Repeats the current track/album. Each time you touch the key, repeat modes are switched in the following sequence:  
Song repeat (🔄), All songs repeat (🔄ALL), Repeat off (🔄)
- 🎲 : Randomly plays all tracks in the current album. Each time you touch the key, random modes are switched in the following sequence:  
Song random (🎲), Random off (🎲)

### 7 Indicator Items

- MUSIC: Identifies the music file.

## Search Operation

You can search music files by the following operations.

1 Touch **Q**.

2 Touch **▼**.



3 Select a list type.

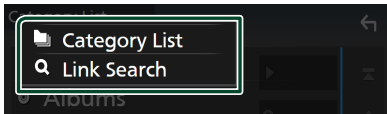

### NOTE

- For operations on the list screen, see **List screen (P.18)**.

## Category search

You can search for a file by selecting a category.

1 Touch **Category List**.

2 Touch the desired category.

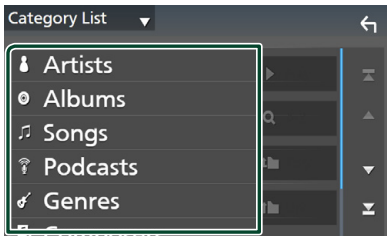

➤ The list corresponding to your selection appears.

3 Touch to select the desired item in the list. Repeat this step until you find the desired file.

## Link search

You can search for a file of the same artist/album/genre/composer as that in the current track.

1 Touch **Link Search**.

2 Touch the desired tag type. You can select from artists, albums, genres and composers.

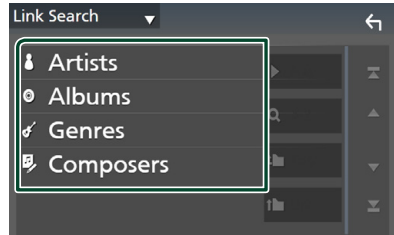

➤ The list corresponding to your selection appears.

3 Touch the desired item in the content list.

# Radio

## Radio Basic Operation

Most functions can be controlled from the source control screen.

To listen to the Radio source, touch **Radio** icon on the source selection screen. (P.15)

### NOTE

- Set the remote control mode switch to **AUD** mode before starting operation, see **Switch the operation mode (P.82)**.

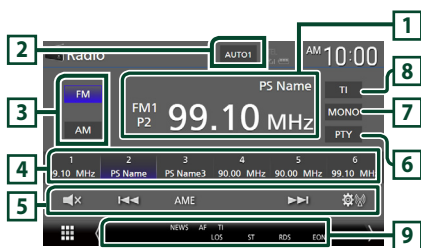

### 1 Information display

Displays the information of the current station: Frequency, PS name

**P#**: Preset number

### 2 Seek mode

Switches the seek mode in the following sequence; **AUTO1**, **AUTO2**, **MANUAL**.

- AUTO1**: Tunes in a station with good reception automatically.
- AUTO2**: Tunes in stations in memory one after another.
- MANUAL**: Switches to the next frequency manually.

### 3 Band button

Switches the band (FM1/FM2/FM3, AM).

### 4 Preset key

Recalls the memorized station.

When touched for 2 seconds, stores the current receiving station in memory.

### 5 Operation keys

- ◀▶**: Tunes in a station. The method of frequency switching can be changed (see **2** in table).
- AME**: Presets stations automatically. For details, see **Auto memory (P.42)**.
- ⚙️**: Displays the Radio SETUP screen. For details, see **Radio Setup (P.43)**.
- 🔇**: Touch to mute or not to mute.

### 6 PTY (FM only)

Searches a program by setting program type. For details, see **Search by program type (P.42)**.

### 7 MONO (FM only)

Select the Monaural reception.

### 8 TI (FM only)

Sets the traffic information mode on. For details, see **Traffic Information (P.43)**.

### 9 Indicator Items

- ST**: A stereo broadcast is being received.
- MONO**: The forced monaural function is on.
- AF**: The AF search function is on.
- EON**: The Radio Data System station is sending EON.
- LOS**: The Local Seek function is on.
- NEWS**: News bulletin interruption is in progress.
- RDS**: Indicates the state of the Radio Data System station when the AF function is on.
  - White: Radio Data System is being received.
  - Orange: Radio Data System is not being received.
- TI**: Indicates the reception state of traffic information.
  - White: TP is being received.
  - Orange: TP is not being received.

## Memory Operation

### Auto memory

You can store stations with good reception in memory automatically.

#### 1 Touch desired band key.

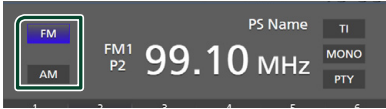

#### 2 Touch AME.



#### 3 Touch Yes.

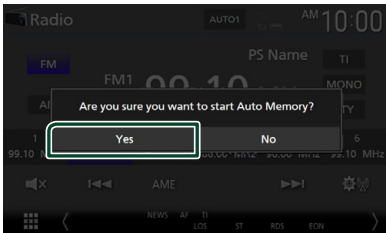

➤ Auto memory starts.

### Manual memory

You can store the current receiving station in memory.

#### 1 Touch desired band key.

#### 2 Select a station you wish to store in memory.

#### 3 Touch # (#:1-6) in which you want to store the station for 2 seconds until a beep sounds.

## Selecting Operation

### Preset select

You can list and select memorized station.

#### 1 Select a station from the list.



### Search by program type (FM only)

You can tune to a station with a specific program type when listening to FM.

#### 1 Touch PTY.



➤ PTY Search screen appears.

#### 2 Select a program type from the list.

#### 3 Touch Search.

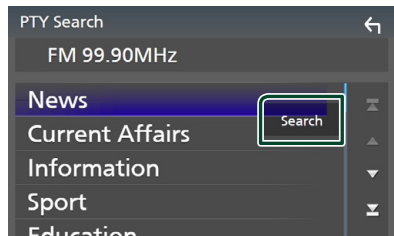

You can search a station of the selected program type.

## Traffic Information (FM only)

You can listen and watch the traffic information automatically when a traffic bulletin starts. However, this feature requires a Radio Data System that includes the TI information.

### 1 Touch TI.



➤ Traffic information mode is set.

### When the traffic bulletin starts

The Traffic Information screen appears automatically.

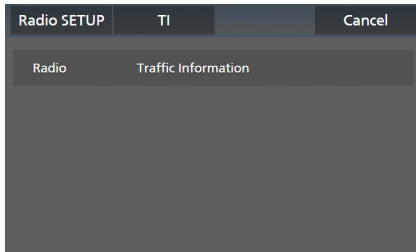

#### NOTE

- It is necessary to have Traffic Information function set to on in order to have the Traffic Information screen appear automatically.
- The volume setting during reception of traffic information is automatically stored. The next time the traffic information is received, this unit recalls the volume setting automatically.
- To cancel Traffic Information: Touch **Cancel**.

## Radio Setup

You can set tuner related parameters.

### 1 Touch .



➤ Radio SETUP screen appears.

### 2 Set each item as follows.

#### ■ NEWS (FM only)

Sets a news bulletin interrupt time. Default is "OFF".

#### ■ AF (FM only)

When station reception is poor, automatically switches to the station that is broadcasting the same program over the same Radio Data System network. Default is "OFF".

#### ■ Regional (FM only)

Sets whether to switch to the station only in the specific region using the "AF" control. Default is "OFF".

#### ■ LO.S (FM only)

Turns the Local Seek function on or off.

#### ■ Auto TP Seek (FM only)

When traffic information station reception is poor, automatically searches for a station that can be received better. Default is "ON".

#### ■ Language Select (FM only)

Selects a display language for the PTY function.

#### ■ Aerial Control

Allows you to turn off the Radio Data System function to prevent the motor-driven antenna from extending. Default is "ON".

# Digital Radio (DDX9019DABS / DMX8019DABS)

## Digital Radio Basic Operation

Most functions can be controlled from the source control screen.

To enter Digital Radio source, touch **Digital Radio** icon in the source selection screen. **(P.15)**

### NOTE

- Set the remote control mode switch to AUD mode before starting operation, see **Switch the operation mode (P.82)**.

### Control screen

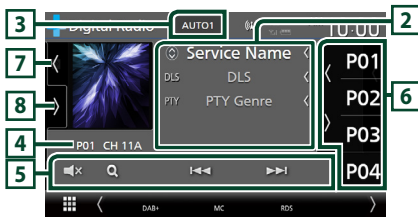

### Open the drawer

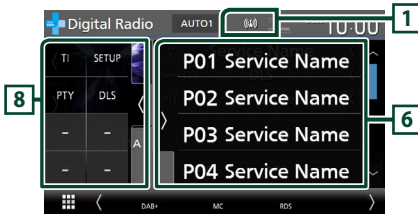

### Close the drawer

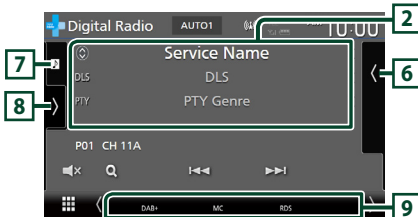

### 1 Indicator display

Displays the received signal strength.

### 2 Information display

- Displays the information on the current station: Service Name

Touching allows you to switch between Content A, Content B and Content C.

Content A: DLS, PTY Genre

Content B: Song Title, Artist Name, Ensemble name

Content C: Now Playing, Next Program, Audio Quality

Touch to switch between the Control and Information screen.

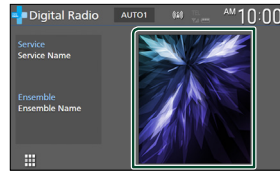

- Change the text size of song information when the "Small Audio Text" is set to "ON"/"OFF" in the User Interface screen **(P.66)**.

### 3 Seek mode

Touch to switch seek modes in the following sequence: **AUTO1**, **AUTO2**, **MANUAL**.

- AUTO1**: Tunes in a ensemble with good reception automatically.
- AUTO2**: Tunes in the memorized ensemble one after another.
- MANUAL**: Switches to the next ensemble manually.

### 4 Indicator display

P#: Preset number

CH#: Channel display

### 5 Operation keys

- : Displays the Service List screen. For details on search operation, see **Service search (P.46)**.
- : Tunes in a ensemble, service, and component. The seek mode switching can be changed. (see **3** Seek mode).
- : Touch to mute or not to mute.

### 6 Preset list

- Touching allows you to change the display size.
- Recalls the memorized service.
- When touched for 2 seconds, stores the currently being received service in the memory.



## 7 Artwork area/VU meter

- Displays/hides artwork area.
- The picture data is displayed if available from current content.
- Touch to switch between the artwork and VU meter.

## 8 Function panel

Touch the left side of the screen to display the function panel. Touch again to close the panel.

- **TI**: Selects the traffic information mode. For details, see **Traffic Information (P.46)**.
- **SETUP**: Displays the Digital Radio SETUP screen. For details, see **Digital Radio Setup (P.47)**.
- **PTY**: Searches for a program by program type. For details, see **Search by program type (P.45)**.
- **DLS**: Display the Dynamic Label Segment screen.

## 9 Indicator Items

- **DAB+**: Digital Radio is being received.
- **RDS**: Radio Data System is being received.
- **MC**: Receiving service is displayed.  
White: Primary Component is received.  
Orange: Secondary Component is received.
- **TI**: Indicates the reception state of traffic information.  
White: TP is being received.  
Orange: TP is not being received.

## Storing Service in Preset Memory

You can store the current receiving service in the memory.

- 1 Select a service you wish to store in memory.
- 2 Touch  on the right side of the screen.

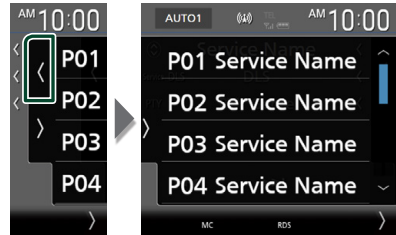

- 3 Touch **P#** (#:1-15) in which you want to store the station for 2 seconds until a beep sounds.

## Selecting Operation

### Search by program type

You can tune in the station broadcasting the specified type of program when listening to Digital Radio.

- 1 Touch  on the left side of the screen. Touch **PTY**.

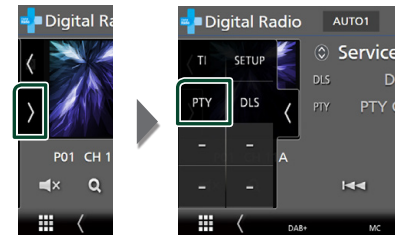

> PTY Search screen appears.

- 2 Select a program type from the list.

### 3 Touch Search.

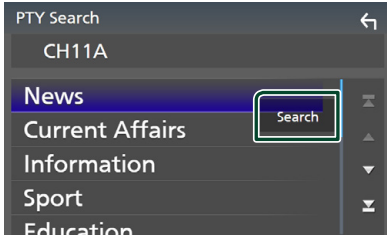

You can search for the station broadcasting the selected type of program.

### Service search

You can select a service from a list of all services received.

#### 1 Touch Q.

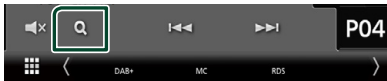

#### 2 Select the desired content from the list.

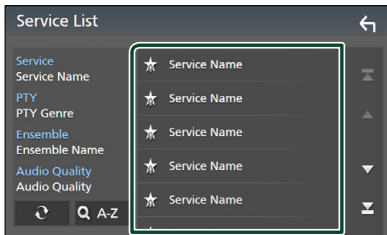

Touch and hold to find the latest service list.

#### QA-Z

Displays the keyboard screen.

Jump to the letter you entered (alphabet search).

## Traffic Information

You can listen to and watch traffic information automatically when a traffic bulletin starts. However, this feature requires a Digital Radio that includes TI information.

#### 1 Touch > on the left side of the screen. Touch TI.



> Traffic information mode is set.

#### When the traffic bulletin starts

The Traffic Information screen appears automatically.

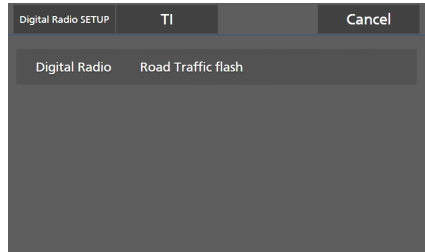

#### NOTE

- It is necessary to turn on the Traffic Information function in order to allow the Traffic Information screen to appear automatically.
- The volume setting made during reception of traffic information is automatically memorized. When the traffic information is received next time, this unit recalls the volume setting automatically.
- To cancel Traffic Information: Touch **Cancel**.

## Digital Radio Setup

You can set Digital Radio related parameters.

- 1 Touch  on the left side of the screen. Touch **SETUP**.



➤ Digital Radio SETUP screen appears.

- 2 Set each function as follows.

### ■ Priority

If the same service is provided by Digital Radio during Radio Data System reception, automatically switches to Digital Radio. If the same service is provided by Radio Data System when reception of the service being provided by Digital Radio becomes poor, automatically switches to Radio Data System.

### ■ PTY Watch

If the service of the set program type begins with the ensemble being received, switches from any source to Digital Radio for service reception.

### ■ Announcement Select

Switches to the set Announcement service. For details, see **Announcement setup (P.47)**.

### ■ Antenna Power

Sets power supply to the Digital Radio antenna. Set to "ON" when the Digital Radio antenna in use is equipped with a booster. Default is "ON".

### ■ Related Service

When you select ON, the unit switches to a related service (if exists) when a Digital Radio service network is not available. Default is "ON".

### ■ Language Select

Selects a display language for the PTY function.

## ■ Announcement setup

When the service for which ON is selected starts, switches from any source to Announcement to receive it.

- 1 Touch **Announcement Select** on the Digital Radio SETUP screen.

➤ The Announcement Select screen appears.

- 2 Touch each Announcement list and set on or off.

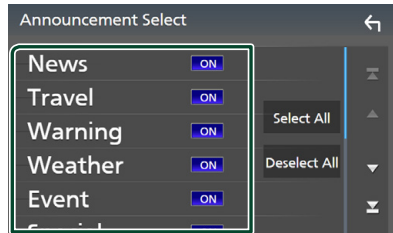

### ■ Select All

Turn on the all announcements.

### ■ Deselect All

Turn off the all announcements.

## NOTE

- The volume setting during reception of Announcement service is automatically stored. The next time the Announcement service is received, this unit recalls the volume setting automatically.

# Bluetooth Control

Using the Bluetooth function allows you to use various functions such as listening to the audio file and making/receiving a call.

## Information for using Bluetooth® devices



Bluetooth is a short-range wireless radio communication technology for mobile devices such as cell-phones, portable PCs, and other devices.

Bluetooth devices can be connected without cables and communication with each other.

### NOTE

- While driving, do not perform complicated operations such as dialing numbers, using the phone book, etc. When you perform these operations, stop your car in a safe place.
- Some Bluetooth devices may not be connected to this unit depending on the Bluetooth version of the device.
- This unit may not work for some Bluetooth devices.
- Connecting conditions may vary depending on your environment.
- Some Bluetooth devices are disconnected when this unit is turned off.
- The Bluetooth devices cannot be used while using Apple CarPlay.
- The Bluetooth currently connected with other device is disconnected when an iPhone compatible with Apple CarPlay is connected.

## About the cell-phone and Bluetooth audio player

This unit conforms to the following Bluetooth specifications:

### Version

Bluetooth Ver. 5.0

### Profiles

#### Cell-phone:

HFP (V1.7) (Hands Free Profile)

SPP (Serial Port Profile)

PBAP (Phonebook Access Profile)

#### Audio player:

A2DP (Advanced Audio Distribution Profile)

AVRCP (V1.6) (Audio/Video Remote Control Profile)

### Sound codec

SBC, AAC

### NOTE

- The units supporting the Bluetooth function have been certified for conformity with the Bluetooth Standard according to the procedure prescribed by Bluetooth SIG.
- However, it may be impossible for such units to communicate with your cell-phone depending on its type.

## Register the Bluetooth device

It is necessary to register the Bluetooth audio player or cell-phone in this unit before using the Bluetooth function.

You can register up to 10 Bluetooth devices.

### NOTE

- Up to 10 Bluetooth devices can be registered. If an attempt is made to register the 11th Bluetooth device, the Bluetooth device connected on the earliest date will be deleted to register the 11th one.
- This unit is compatible with the Apple Easy Pairing function. When an iPod touch or iPhone connected via USB terminal previously is connected again, an authentication dialog appears. Performing operation for authentication on this unit or iOS smartphone registers the smartphone as a Bluetooth device.

### 1 Press the **MENU** button.

- Popup menu appears.

### 2 Touch **SETUP**.



- SETUP Menu screen appears.

### 3 Touch **Bluetooth**.

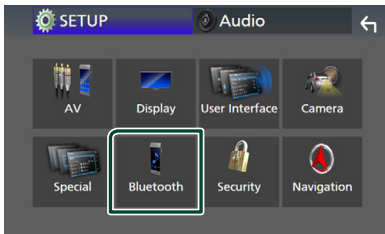

- Bluetooth SETUP screen appears.

### 4 Touch **Select Device** on the Bluetooth Setup screen.

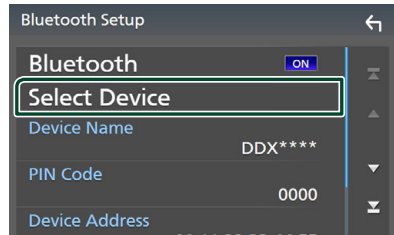

### 5 Touch **+0** on the Select Device screen.

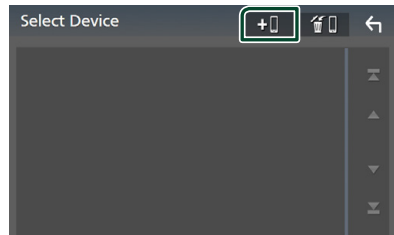

- Bluetooth pairing waiting dialog appears.

### NOTE

- You can also register an iPhone on the Apple CarPlay Device List screen. **(P.29)**
- When neither Apple CarPlay, Android Auto, nor a Bluetooth Hands-Free phone is connected, pressing and holding the **+0** button displays Bluetooth pairing waiting dialog.

### 6 Search for the unit ("DDX\*\*\*\*"/"DMX\*\*\*\*") from your smartphone/cell-phone.

Complete steps 6 to 9 within 30 seconds.

### 7 Operate your smartphone/cell-phone according to the displayed messages.

- **Confirm the request both on the smartphone/cell-phone.**

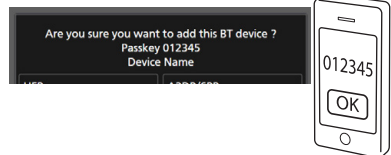

## Bluetooth Control

### ● Input the PIN Code in your smartphone/cell-phone.

PIN Code is set to "0000" as the default.

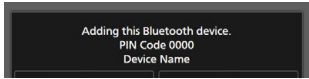

### 8 Select the function you want to use.

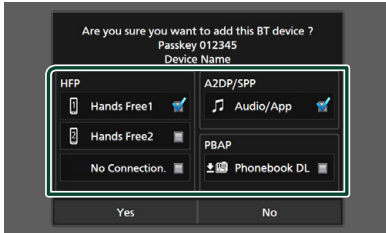

#### ■ HFP Hands Free1/Hands Free2/No Connection.

Select the hands-free number to connect.

#### ■ A2DP/SPP Audio/App

Select if you want to use the audio player app in your smartphone over A2DP, and the other apps in your smartphone over SPP.

#### ■ PBAP Phonebook DL

Select if you want to transfer your phonebook data.

### 9 Touch Yes.

When data transmission and connection have completed, the Bluetooth connection icon appears on the screen.

#### NOTE

- When registering the iPhone that is available for Apple CarPlay wirelessly, a confirmation message appears.
  - **Yes**: Displays the Apple CarPlay screen for wireless connection.
  - **No**: Apple CarPlay is not connected. When using Apple CarPlay, see **Select an Apple CarPlay device (P.29)**.

## Bluetooth Setup

#### NOTE

- The Bluetooth Setup is disabled while using Apple CarPlay.

### 1 Press the **MENU** button.

- Popup menu appears.

### 2 Touch **SETUP**.

- SETUP Menu screen appears.

### 3 Touch **Bluetooth**.

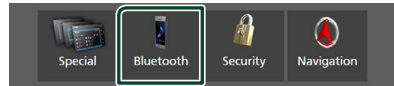

- Bluetooth SETUP screen appears.

See the following section for each setting.

- Connect the Bluetooth device (**P.50**)
- Change the PIN Code (**P.52**)
- Change the device name (**P.51**)

### ■ Connect the Bluetooth device

#### 1 Touch **Select Device** on the Bluetooth Setup screen.

#### 2 Touch the name of the device you want to connect.

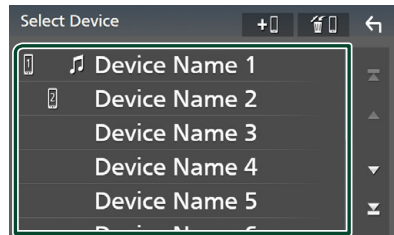

- Profile select screen appears.

#### NOTE

- If the icon is lighted, it means that the unit will use that device.
- You cannot select an Android device connected as an Android Auto device.

### 3 Set each profile as follows.

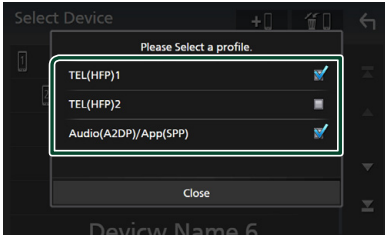

#### ■ TEL (HFP) 1, TEL (HFP) 2

Select when the device is connected with the unit as hands-free phone 1 or 2.

#### ■ Audio (A2DP)/App (SPP)

Select to interwork with an application installed in a smartphone or to use as an audio player.

### 4 Touch **Close**.

#### *To delete the registered Bluetooth device*

### 1 Touch on the Select Device screen.

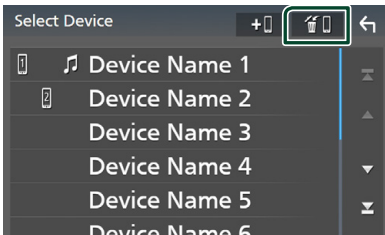

### 2 Touch the device name to check.

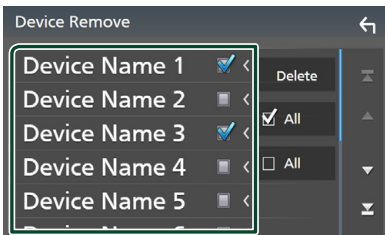

#### ■ All

Selects all Bluetooth devices.

#### ■ All

Clears all check marks.

#### NOTE

- You cannot select an Android device connected as an Android Auto device.

### 3 Touch **Delete**.

- Confirmation message appears.

### 4 Touch **Yes**.

- All the selected device(s) is deleted.

#### NOTE

- If the device compatible with wireless Apple CarPlay is deleted, the same device is deleted from the Apple CarPlay device list screen.

## Change the device name

### 1 Touch **Device Name** on the Bluetooth SETUP screen.

- Change Device Name screen appears.

### 2 Touch and hold .

### 3 Input the device name.



### 4 Touch **Enter**.

## Change the PIN Code

- 1 Touch **PIN Code** on the Bluetooth SETUP screen.
  - Change PIN Code screen appears.
- 2 Touch and hold **BS**.
- 3 Input the PIN Code.

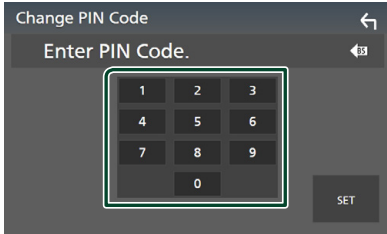

- 4 Touch **SET**.

## Playing the Bluetooth Audio Device

Most function can be controlled from the source control screen.

To select Bluetooth source, touch **Bluetooth** icon on the source selection screen. (P.15)

### NOTE

- The Bluetooth audio source is disabled while using Apple CarPlay.
- The Bluetooth audio source is disabled when the device set as Audio(A2DP)/App(SPP) is using Android Auto.

## Bluetooth basic operation



### 1 Artwork/VU meter

- Displays/hides artwork area.
- Touch to switch between the artwork and VU meter.

### 2 Play mode indicator/Playing time

▶, ||: Current play mode indicator

Meanings of individual icons are as follows:

- ▶ (play), ▶▶ (fast forward), ◀◀ (fast backward), || (pause), ■ (stop).

### 3 Operation keys \*









- 🔍: Searches for a file. See **File search (P.54)**.
- ◀◀ ▶▶: Searches for the previous/next content.  
Touch and hold to fast forward or fast backward. (It will be cancelled automatically after about 50 seconds.)
- ▶: Plays.
- ||: Pauses.
- 📶: Displays the Bluetooth SETUP screen. (P.50)
- 🔇: Touch to mute or not to mute.



#### 4 KENWOOD Music Mix

Bluetooth audio devices can be switched easily to play music. See **KENWOOD Music Mix (P.53)**.

#### 5 / \*

- : Repeats the current track/folder. Each time you touch the key, repeat modes are switched in the following sequence: File repeat (  ), Folder repeat (  ), All songs repeat (  ), Repeat off (  )
- : Randomly plays all tracks in the current folder. Each time you touch the key, random modes are switched in the following sequence: Folder random (  ), All random (  ), Random off (  )

#### 6 Information display \*

- Displays the name of track information.
- Connected device name.
- Change the text size of song information when the "Small Audio Text" is set to "ON"/"OFF" in the User Interface screen (P.66).

\*These items appear only when the audio player which supports AVRCP profile is connected.

#### NOTE

- The operation buttons, indications and information displayed on the screen differ depending on the connected device.
- If the operation keys do not appear, operate from the player.
- Depending on your cell-phone or audio player, sound may be heard and controlled but text information may not appear.
- If the volume is too low, raise it on your cell-phone or audio player.



#### KENWOOD Music Mix

Up to 5 Bluetooth audio device can be connected and switched easily to play music.



#### 1 Touch .

- A list of registered devices is displayed.

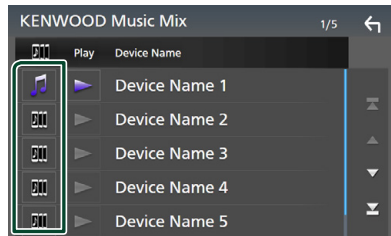

#### 2 Touch of device name you want to connect.

- Touching  displays the Bluetooth device connection setup screen. (P.50)
- Touching  on the left of the connected device (  ) disconnects this device.





- : Device used normally.
- : Device used for KENWOOD MusicMix

#### 3 Touch (white) on the left of the name of the device to be played.

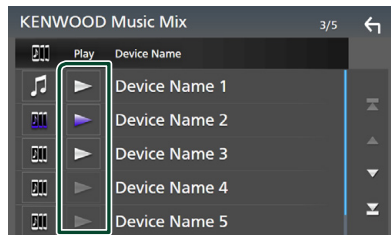
-  (white) changes to  (purple) and starts playback.



-  (Gray): Not connected.
-  (White): Connected.
-  (Purple): During playback.

#### 4 Touch .

**NOTE**

- If a connected Bluetooth audio device is operated to play music, connections are switched.
- When a Bluetooth source is switched to another one, its settings are deleted and the connection is restored to the connection before source switching.
- You cannot select an Android device connected as an Android Auto device.

**File search**

- 1 Touch **Q**.
- 2 Touch the desired file or folder.

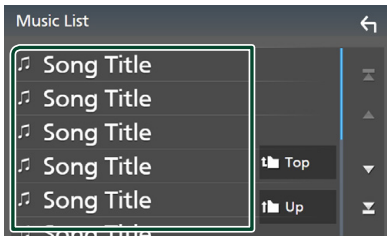

When you touch a folder its contents are displayed.

- 3 Touch the desired item in the content list.  
➤ Playback starts.

**NOTE**

- For operations in the list screen, see **List screen (P.18)**.

**Using the Hands-Free Unit**

You can use the telephone function by connecting the Bluetooth telephone to this unit.

**NOTE**

- If you use the hands-free function frequently, move the TEL short-cut button (icon) to the Home screen. **(P.16)**
- While Apple CarPlay or Android Auto is connected, the Bluetooth Hands-Free function and two Bluetooth devices connections cannot be used. Only the Apple CarPlay or Android Auto Hands-Free function can be used.

**Make a call**

- 1 Press the **HOME** button.
- 2 Touch **☐**.
- 3 Touch **TEL**.

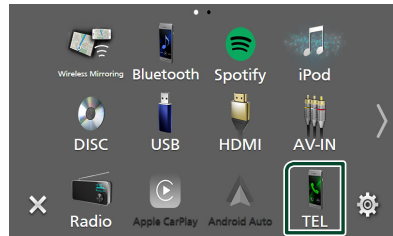





➤ Hands Free screen appears.

**NOTE**

- If your cell-phone supports PBAP, you can display the phone book and call lists onto the touch panel screen when the cell-phone is connected.
  - Phone book: up to 1000 entries
  - Up to 50 entries including dialed calls, received calls, and missed calls

#### 4 Select a dialing method.



- : Call using call records
- : Call using the phonebook
- : Call using the preset number
- : Call by entering a phone number

#### ● Select the cell-phone to use

When you connect two cell-phones

- 1) Touch  to select the phone you want to use.

#### ● Bluetooth SETUP

- 1) Touch .  
Bluetooth SETUP screen appears.

#### ● Voice Recognition

- 1) Touch . (P.56)

#### NOTE



- Status icons such as battery and antenna icons may differ from those displayed on the cell-phone.
- Setting the cell-phone in the private mode can disable the hands-free function.

#### Call using call records

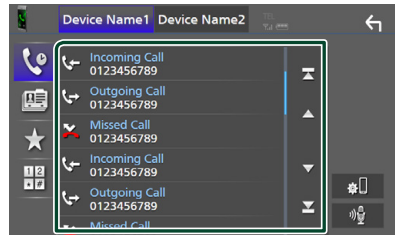
- 1 Touch .
- 2 Select the phone number from the list.



#### Call using the phonebook

- 1 Touch .
- 2 Touch  A-Z.
- 3 Select the initial.



- Characters with no corresponding name will not appear.
- A first character with an accent character such as "ü" can be searched for with a non-accent character "u". A character with an accent character in a sentence cannot be searched for.

- 4 Select the person you want to call from the list.

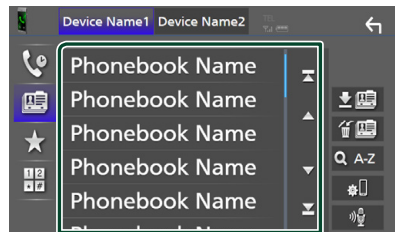

5 Select the phone number from the list.

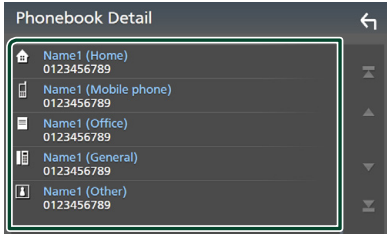

**NOTE**

- You can sort the phone numbers in the list by last name or first name. For details, see **Hands-Free Setup (P.59)**.

**Call using the preset number**

- 1 Touch .
- 2 Touch the name or phone number.

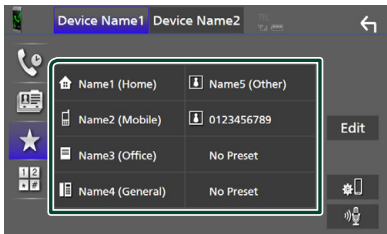

**Call by entering a phone number**

- 1 Touch .
- 2 Enter a phone number with number keys.

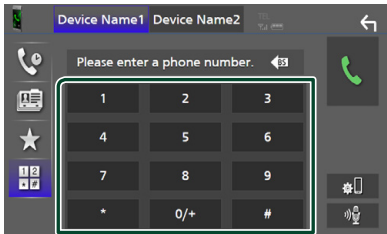

- 3 Touch .

**Voice Recognition**

You can access the voice recognition function of the cell-phone connected to this unit. You can search the cell-phone phonebook by voice. (The functionality depends on the cell-phone.)

- 1 Press the  button for 1 second.

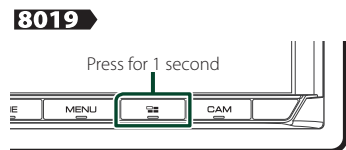
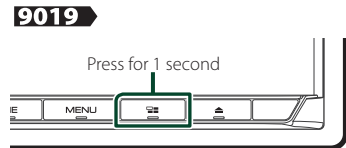
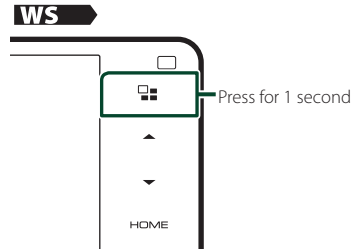



➤ Voice Recognition screen appears.

- 2 Start speaking.

**NOTE**

- You can use the voice recognition function by touching  on the Hands Free screen.

## Receive a call

- 1 Touch  to answer a phone call or  to reject an incoming call.

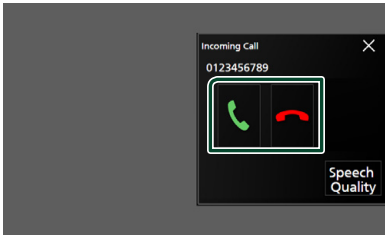

### NOTE

- While monitoring the picture from the view camera, this screen does not appear even if a call comes in.

## To end call

- 1 While talking, touch .

## Operations during a call



### ● Adjust the volume of your voice

- 1) Touch **Speech Quality**.
- 2) Touch ◀ or ▶ for **Microphone Level**.

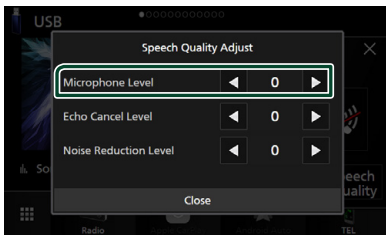

### ● Adjust the receiver volume

Press the ▼ or ▲ button.

#### WS

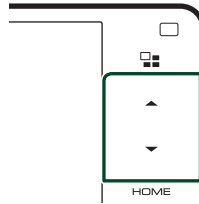

#### 9019



#### 8019





### ● Mute your voice

Touch  to mute or not to mute your voice.

### ● Output the dial tone

Touch **DTMF** to display the tone input screen. You can send tones by touching desired keys on the screen.

### ● Switching between speaking voice output destinations

Touching  /  each time switches speaking voice output destinations between the cell-phone and the speaker.

### ● Call-waiting

When you receive a new call while talking on the phone, you can answer the newly received call by touching . The current call is put on hold.

Each time you touch , the caller will change to the other one.

When you touch , the current call will end to be switched to the call waiting on hold.

### ● To close the Hands-Free popup screen

Touching × to close the Hands-Free popup screen.

## Bluetooth Control

### To display it again

- 1 Press the **HOME** button.
- 2 Touch .
- 3 Touch **TEL**.

### Phone number preset

You can register frequently used phone numbers in this unit.

- 1 Touch .
- 2 Touch **Edit**.

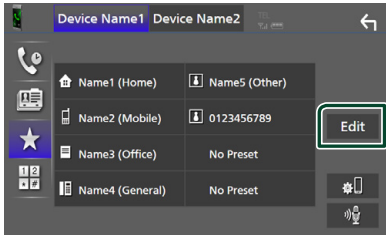

- 3 Select where to preset.

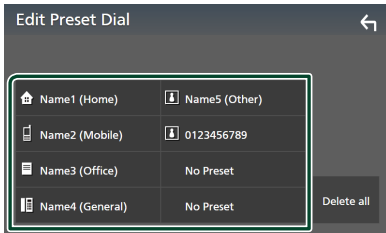

#### ■ Delete all

To delete all preset numbers, touch **Delete all** and then touch **Yes** on the confirmation screen.

- 4 Select how to preset.

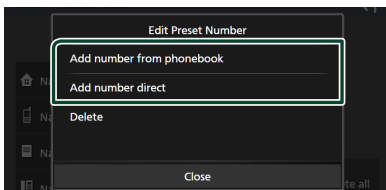

#### ■ Add number from phonebook

Select the number to preset from the phonebook. See **Call using the phonebook (P.55)**.

#### ■ Add number direct

Enter the telephone number directly and touch **SET**. See **Call by entering a phone number (P.56)**.

#### ■ Delete

To delete a preset number, touch **Delete** and then touch **OK** on the confirmation screen.

### Phonebook transfer

You can transfer phonebook data from your Bluetooth smartphone using PBAP.

- 1 Touch .
- 2 Touch .

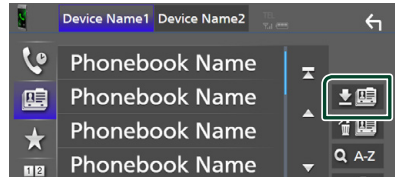

> Phonebook data transfer starts.

#### NOTE

- If the Phonebook contains more than 1000 entries, Phonebook data cannot be transferred.
- If no Phonebook has been downloaded, touching **Download Phonebook Now** will start downloading the Phonebook.

### Phonebook deletion

- 1 Touch .
- 2 Touch the name to check.

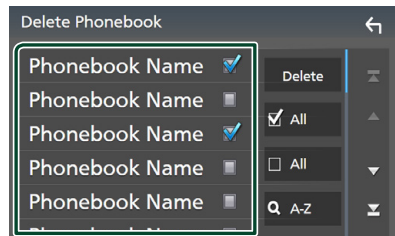

#### ■ All

Checks all boxes.

#### ■ All

Clears all check marks.

**3 Touch Delete.**

- Confirmation message appears.

**4 Touch Yes.****Hands-Free Setup**

You can make various settings for the Hands-Free function.

**1 Press the MENU button.**

- Popup menu appears.

**2 Touch SETUP.**

- SETUP Menu screen appears.

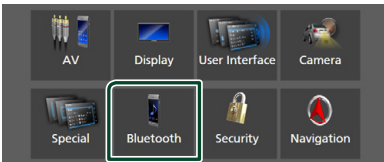
**3 Touch Bluetooth.**

- Bluetooth SETUP screen appears.

**4 Touch TEL SETUP.**

- TEL SETUP screen appears.

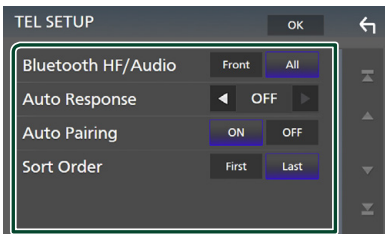
**5 Set each function as follows.****Bluetooth HF/Audio**

Select the speakers to output the sound from the cell-phone (such as phone call voice and ringing tone) and Bluetooth audio player.

**Front**: Outputs sound from the front speakers.

**All** (Default): Outputs sound from all speakers.

**Auto Response\***

Set the automatic response time to pick-up an incoming call.

**OFF** (Default): Turns off the Automatic response function.

**1/5/10/15/20/25/30**: Sets the ringing time (second).

**Auto Pairing**

When set to "ON", the Apple Auto Pairing function is turned on to automatically register the iPod touch or iPhone connected to this unit.

**ON** (Default): Turns on the Apple Auto Pairing function.

**OFF**: Turns off the Apple Auto Pairing function.

**Sort Order**

Set how to sort the data in the cell-phone phonebook.

**First**: Sorts data by the first name.

**Last** (Default): Sorts data by the last name.

\* Either the auto response time set on this unit or the time set on the cell-phone, whichever is shorter takes effect.

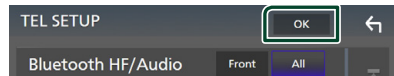
**6 Touch OK.**

# Other External Components

## View Camera

### NOTE

- To connect a camera, see **P.96**.
- To use a rear view camera, a REVERSE lead connection is required. **(P.91)**
- If **Rear Camera Interruption** is active the camera screen is displayed when you shift the gear to the reverse (R) position.

### Display the camera screen

**1** Press the **MENU** button.

- Popup menu appears.

**2** Touch **Camera**.

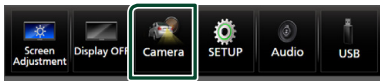

- View camera screen appears.

**3** Adjust each item as follows.

To erase the caution message, touch the screen.

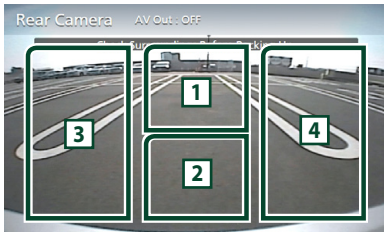

#### **1** Switching the View Camera \*1

Touch to display the camera switching keys. It is necessary to set "Camera Assignment Settings" beforehand. See **To switch the view camera (P.60)**.

#### **2** Camera off

Touch to exit the camera screen.

#### **3** Switching the Guideline \*2

Touching each time turns on or off the guideline.

#### **4** Switching the Angle \*2

Touching each time changes camera angles.

\*1 When two or more cameras of rear, front, left, and right are connected with this unit.

\*2 When CMOS-3xx series is connected with this unit.

### To switch the view camera

**1** Touch **1**.

- Camera switching keys appear left/right side.

**2** Select a view camera you want to switch.

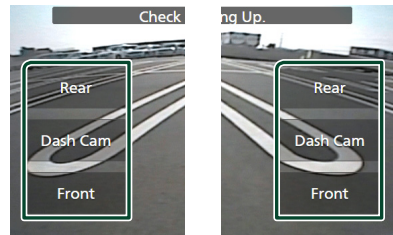

### NOTE

- To switch to the picture other than selectable view camera from the camera switching keys, change the key function of except "Rear" in **Camera Assignment Settings . (P.61)**

### Camera Setup

**1** Press the **MENU** button.

- Popup menu appears.

**2** Touch **SETUP**.

- SETUP Menu screen appears.

**3** Touch **Camera**.

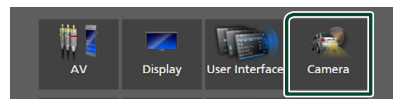

- Camera screen appears.



#### 4 Set each item as follows.

##### ■ Camera Assignment Settings

Set up the camera assignment. See **To set up the camera assignment settings (P.61)**.

##### ■ Rear Camera Interruption

**ON**: Displays the picture from the rear view camera when you shift the gear to the reverse (R) position.

**OFF** (Default): Select this when no camera is connected.

##### ■ Rear Camera Settings \*1

Adjusts the CMOS-3xx series with ID 1 ("Rear Camera") set. For details, see the instruction manual of your camera.

##### ■ Parking Guidelines

You can display parking guidelines to enable easier parking when you shift the gear to the reverse (R) position.

Default is "ON".

##### ■ Guidelines SETUP

If you select **ON** for **Parking Guidelines**, you can adjust the parking guidelines. See **To adjust the parking guidelines (P.62)**.

##### ■ Front Camera Settings \*2

Adjusts the CMOS-3xx series with ID 2 ("Front Camera") set. For details, see the instruction manual of your camera.

##### ■ Front Camera Interruption \*3

**10 sec / 15 sec** (Default) / **20 sec**: The front camera screen is displayed when return the gear from the reverse (R) position.

**OFF**: Cancel.

\*1 When CMOS-3xx series is connected with this unit.

\*2 To use the function, it is necessary to connect CMOS-3xx series and to set **Camera Assignment Settings** to **Front**. (P.61)

\*3 To use the function, it is necessary to set **Rear Camera Interruption** to **ON** and to set **Camera Assignment Settings** to **Front**. (P.61)

#### ■ To set up the camera assignment settings

1 Touch **Camera Assignment Settings** on the Camera screen. (P.60)

2 Set each item as follows.

##### ■ FRONT VIEW CAMERA / DASH CAM

Set the camera assignment from view camera connected to Front view camera/ Dashboard camera input terminal.

##### ■ AV-IN

Set the camera assignment from view camera connected to AV-IN input terminal.

#### For Front view camera/Dashboard camera input terminal:

1 Touch **FRONT VIEW CAMERA / DASH CAM**.

➤ Displays the picture from view camera connected to Front view camera/ Dashboard camera input terminal.

2 Select the view camera to set up.

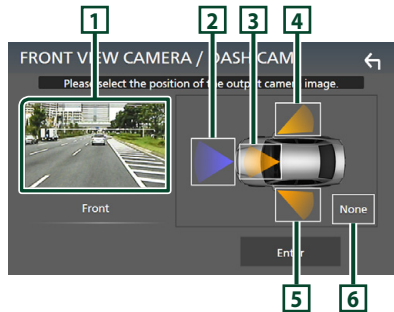

1 **Picture from view camera**

Displays the picture from view camera connected to Front view camera/Dashboard camera input terminal. (P.96)

2 **Front**

3 **Dashboard Camera**

4 **Right**

5 **Left**

6 **None**

3 Touch **Enter**.

## Other External Components

### For AV-IN input terminal:

#### 1 Touch AV-IN.

- ▶ Displays the picture from view camera connected to AV-IN input terminal.

#### 2 Select the view camera to set up.

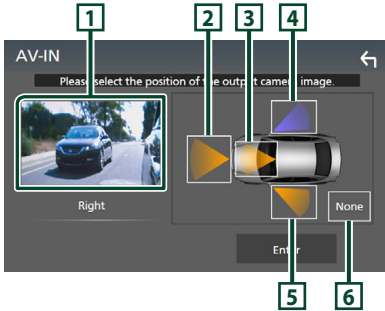

#### 1 Picture from view camera

Displays the picture from view camera connected to AV-IN input terminal. (P.96)

#### 2 Front

#### 3 Dashboard Camera

#### 4 Right

#### 5 Left

#### 6 None

#### 3 Touch Enter.

##### NOTE

- The Dashboard Camera can be selected when it is connected. (P.96)

## To adjust the parking guidelines

##### NOTE

- Install the rear view camera in the appropriate position according to the instruction manual supplied with the rear view camera.
- When adjusting the parking guidelines, make sure to apply the parking brake to prevent the car from moving.

#### 1 Touch **Parking Guidelines** in the Camera screen and set to **ON**. (P.60)

#### 2 Touch **Guidelines SETUP** on the Camera screen.

#### 3 Adjust the parking guidelines by selecting the mark.

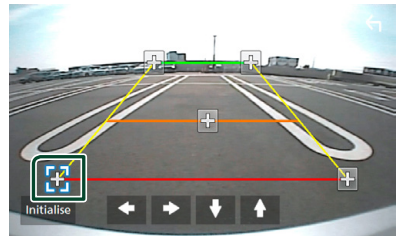

#### 4 Adjusting the position of the selected mark.

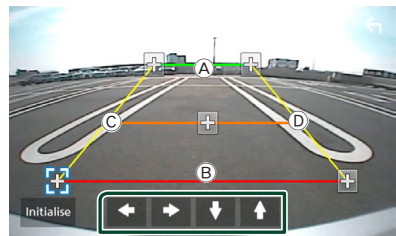

Make sure that lines **A** and **B** are horizontally parallel, and that lines **C** and **D** are of the same length.

##### NOTE

- Touch **Initialise** and then touch **Yes** to set all the  marks to their initial default position.

## Use Dashboard Camera

A Dashboard Camera, DRV-N520 (optional accessory), connected to this unit lets you play video-recorded data and so on.

For details, see the instruction manual of the Dashboard Camera DRV-N520 (optional accessory).

### NOTE

- To connect a dashboard camera, see **P.96**.
- To use the dashboard camera function, it is necessary to set "Camera Assignment Settings" to "Dashboard Camera". (**P.61**)

## Display the dashboard camera screen

- 1 Press the **MENU** button.  
➤ Popup menu appears.
- 2 Touch **Camera**.

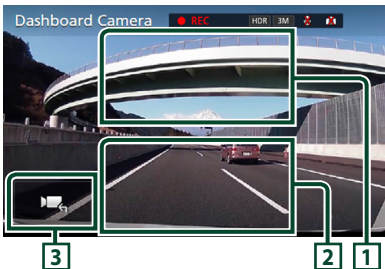

### 1 Switching the View Camera

Touch to display the camera switching keys. It is necessary to set "Camera Assignment Settings" beforehand. See **To switch the view camera (P.60)**.

### 2 Camera off

Touch to exit the camera screen.

### 3 Key display

Touch to display the dashboard camera control keys.

## External audio/video players (AV-IN)

- 1 Connect an external component to the AV-IN input terminal. (**P.93**)
- 2 Select **AV-IN** as the source. (**P.15**)
- 3 Turn on the connected component and start playing the source.

### NOTE

- To select the AV-IN source, it is necessary to set "AV-IN" to "None" in **Camera Assignment Settings**. (**P.61**)

## HDMI source (Except DMX8019S)

- 1 Connect your smartphone to the HDMI input terminal. (**P.93**)  
Use HDMI cable KCA-HD100 (optional accessory).
- 2 Select **HDMI** as the source. (**P.15**)
- 3 Start an application or playback on your smartphone.

## TV tuner

You can connect the TV tuner (commercially available) with this unit and watch TV.

### Preparation

- When you use TV control function, connect the TV tuner (commercially available) and set 3rd Party TV Tuner Control in **AV Setup (P.71)** to ON.
- The TV tuner can be controlled with its supplied remote control through the remote sensor on the front panel of this unit.

**1** Select **TV** as the source. (P.15)

**2** Touch Key display area.

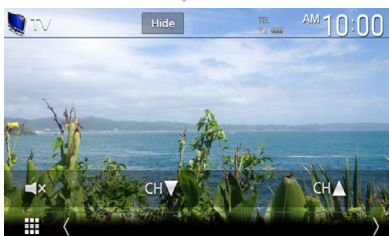
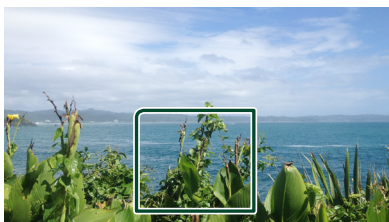

■ Hides the indicators and buttons.

Touch **Hide**.

■ Change the channel.

Touch **CH▲**, **CH▼**.

## Using the external navigation unit (Except Indonesia models and DMX8019DABS)

You can connect a navigation unit (KNA-G630: optional accessory) to the navigation input terminal so that you can view the navigation screen. (P.93)

The navigation guidance comes out of the front speakers even when you are listening to an audio source.

### Display the navigation screen

**1** Press the **HOME** button.

**2** Touch .

**3** Touch **NAV**. (P.15)

➤ The navigation screen appears.

### Navigation Setup

**1** Press the **MENU** button.

➤ Popup menu appears.

**2** Touch **SETUP**.

➤ SETUP Menu screen appears.

**3** Touch **Navigation**.

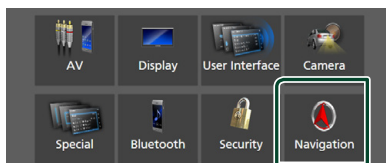

➤ Navigation SETUP screen appears.

**4** Set each item as follows.

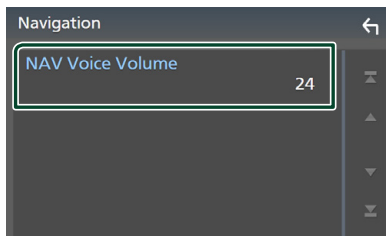

■ **NAV Voice Volume**

Adjusts the volume for voice guidance of the navigation system. Default is "24".

# Setup

## Monitor Screen Setup

You can adjust the image quality of video, menu screen, etc.

### 1 Press the **MENU** button.

- Popup menu appears.

### 2 Touch **Screen Adjustment**.

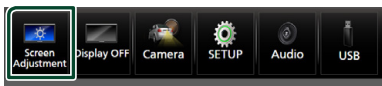

- Screen Adjustment screen appears.

### 3 Adjust each setting as follows.

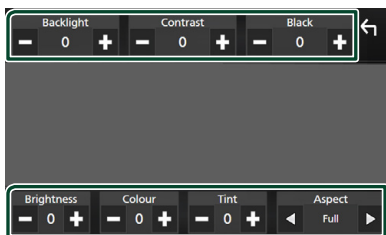

#### ■ **Backlight / Contrast / Black / Brightness / Colour / Tint**

Adjust each setting.

#### ■ **Aspect**

Select a screen mode.

**Full**: Changes the aspect ratio of video and displays video fully on the screen.

**Normal**: Displays video at the ratio of 4:3.

#### **Auto**:

DVD, VCD and disc media: 16:9 video is displayed in the Full mode and 4:3 video is displayed in the Regular mode.

USB device: Displays video fully (vertically or horizontally) with no ratio change.

#### NOTE

- Settings to adjust vary depending on the current source.

## System Setup

### 1 Press the **MENU** button.

- Popup menu appears.

### 2 Touch **SETUP**.

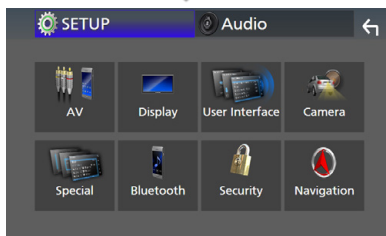

See the following section for each setting.

- Set up AV ([P.71](#))
- Set up display ([P.69](#))
- Set up the user interface ([P.66](#))
- Set up camera ([P.60](#))
- Set up special ([P.68](#))
- Set up Bluetooth ([P.50](#))
- Set up security ([P.9](#))
- Set up navigation ([P.64](#))

## User Interface Setup

You can setup user interface parameters.

### 1 Press the **MENU** button.

➤ Popup menu appears.

### 2 Touch **SETUP**.

➤ SETUP screen appears.

### 3 Touch **User Interface**.

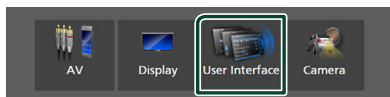

➤ User Interface screen appears.

### 4 Set each parameter as follows.

#### ■ **Small Audio Text**

Change the text size for the source control screen.

**ON** (Default): Change the text size smaller.

**OFF**: Cancel.

#### ■ **Steering Remote Controller**

Sets the desired function in the steering remote controller.

See *Learning function of steering remote.* (P.67)

#### ■ **Beep (B019)**

Turn the key touch tone on or off.

Default is "ON".

#### ■ **Beep Volume (LWS / 9019)**

Set the sound volume of the key touch tone.

"0" (Off) – "3" (Default) – "5"

#### ■ **Widget SETUP**

Set up the widget displayed on the Home screen. (P.21)

#### ■ **Gesture Control** \*1

Select to be on or off the Gesture Control. (P.68)

Default is "ON".

#### ■ **Gesture Beep** \*1

The beep comes out when a gesture is detected.

Default is "ON".

#### ■ **Gesture SETUP** \*1

Assign the functions or sources/screens to display for gesture control. (P.68)

#### ■ **Gesture Sensitivity** \*1

If you have selected **OFF** for **Gesture Control**, adjust the detection range of the Gesture Control from "1"(short) to "12"(long). Default is "7".

#### ■ **Language Select**

Select a language.

#### ■ **Touch Panel Adjust (DMX8019S)**

Adjust the sensing position of the touch panel. (P.67)

#### ■ **Time Format**

Select the time display format.

"12-Hour" (Default)/"24-Hour"

#### ■ **Clock**

**GPS-SYNC** (Default): Synchronizes the clock time with the GPS.

**Manual**: Set the clock manually.

#### ■ **Time Zone**

If you have selected **Manual** for Clock, select the time zone.

#### ■ **Clock Adjust**

If you select **Manual** for Clock, adjust the date and time manually. (P.67)

#### ■ **Travel Prayer for Safe Drive** \*2

When this function is set, the prayer for driving safety is displayed when the unit is turned on, then Quran is played.

Turns the Safe drive pray function on or off.

#### ■ **Travel Prayer for Safe Drive Volume** \*2

If you have selected **ON** for **Travel Prayer for Safe Drive**, sets the sound volume of Quran.

\*1 DDX919WS / DDX919WSM only

\*2 DDX919WSM / DDX9019SM only

## Adjust the date and time manually

- 1 Touch **Clock** on the User Interface screen.
- 2 Select **Manual**.
- 3 Touch **Time Zone** on the User Interface screen.
- 4 Select the time zone.
- 5 Touch **Clock Adjust** on the User Interface screen.
- 6 Adjust the date, then adjust the time.

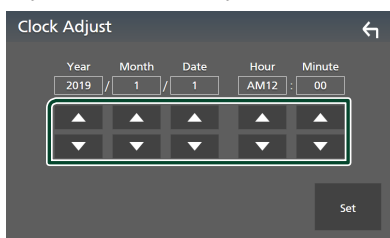

- 7 Touch **Set**.

## Touch panel adjustment

- 1 Touch **Touch Panel Adjust** on the User Interface screen.
  - Touch Panel Adjust screen appears.
- 2 Follow the instruction on the screen and long touch the center of each .

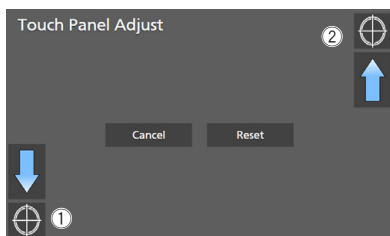

### NOTE

- To cancel the touch panel adjustment, touch **Cancel**.
- To reset it to the default, touch **Reset**.

## Learning function of steering remote

This function is available only when your vehicle is equipped with the electrical steering remote controller.

If your steering remote controller is not compliant, learning may not be completed and error message may appear.

- 1 Touch **Steering Remote Controller** in the User Interface screen.
  - Steering Remote Controller Setting screen appears.
- 2 Press and hold the steering remote controller button.

### NOTE

- You can have the unit learned all buttons at a time. In that case, press the all buttons one at a time and after pressing all of them, touch **Learning completed** in Steering Remote Controller Setting screen. However, new functions cannot be learned after this operation.

- 3 Touch the function you want to set.

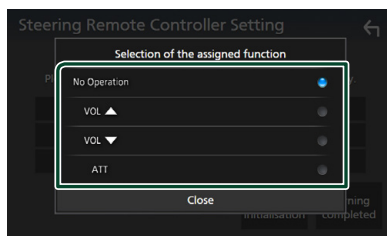

- 4 Repeat steps 2 and 3 as necessary.

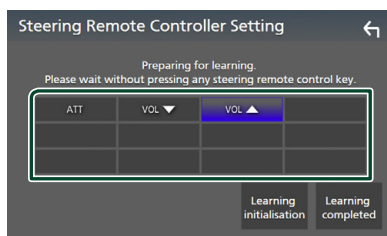

## 5 Touch Learning completed.

### NOTE

- When changing the function already learned, press and hold the button you want to change in step 2 and then touch to select the changed function from the function list.
- Confirm the contents of the settable function on the function list. You cannot edit the function list.
- To initialize the contents, touch **Learning initialisation of Steering Remote Controller** in User Interface screen. After you touch **Initialise**, a confirmation message appears. Follow the message and complete the operation.

## Register operations by Gesture Control (WVS)

You can register operations that work by the motion of your hand.

### 1 Touch **Gesture SETUP** on the User Interface screen.

- Gesture SETUP screen appears.

### 2 Touch a gesture mark you want to set.

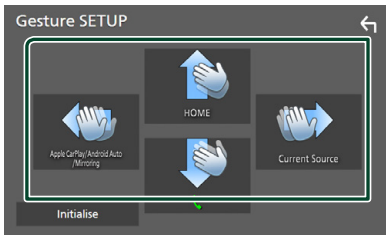

#### ■ **Initialise**

Return to the initial setting. The confirmation message appears. Touch **Yes**.

### 3 Touch the function you want to set.

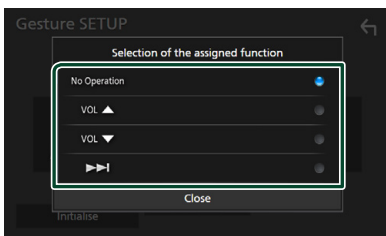

### 4 Repeat steps 2 and 3 as necessary.

### 5 Touch .

## Special Setup

You can setup special parameters.

### 1 Press the **MENU** button.

- Popup menu appears.

### 2 Touch **SETUP**.

- SETUP screen appears.

### 3 Touch **Special**.

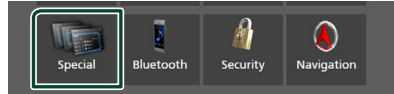

- Special screen appears.

### 4 Set each parameter as follows.

#### ■ **DEMO**

Select the demonstration mode. Default is "ON".

#### ■ **Software Information**

Confirm the software version of this unit.  
**(P.68)**

#### ■ **Open Source Licenses**

Display the open source licenses.

#### ■ **Initialise**

Touch **Initialise** and then touch **Yes** to set all the settings to the initial default settings.

- Audio SETUP Memory is not initialized.

## Software Information

You can confirm the software version of this unit.

### 1 Touch **Software Information** in the **Special** screen.

### 2 Confirm the software version.

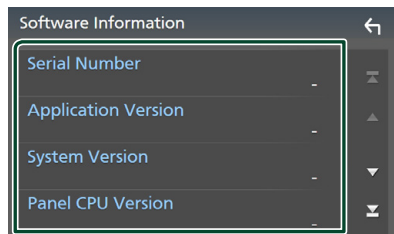



**NOTE**

- For how to update the software, see the relevant update procedure manual which comes with the software.

## Display Setup

### 1 Press the **MENU** button.

- Popup menu appears.

### 2 Touch **SETUP**.

- SETUP screen appears.

### 3 Touch **Display**.

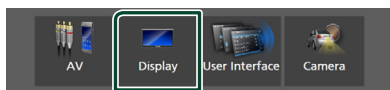

- Display screen appears.

### 4 Set each parameter as follows.

#### ■ **Dimmer**

Select the dimmer mode.

**OFF**: Does not dim the display and keys.

**ON**: Dims the display and keys.

**SYNC** (Default): Turns the dimmer function on or off when the vehicle light control switch is turned on or off.

#### ■ **OSD Clock**

Select if you want to display the clock while the screen is off, or while watching DVD video and video files (USB, Disc media), etc. "ON" (Default)/"OFF"

#### ■ **Key Colour**

You can set the key illumination color. (P.69)

#### ■ **Wallpaper Customize**

You can change the wallpaper image or color. (P.70)

#### ■ **Viewing Angle**

(DMX8019DABS / DMX8019S)

If it is hard to see the image on the screen evenly, adjust the viewing angle. The smaller the (negative) value, the more whitish the image on the screen looks.

"0" (Default)/"-1"/"-2"/"-3"

#### ■ **Screen transition effect**

Select whether to use the screen transition effect when the source control screen is switched to the Home screen.

"ON" (Default)/"OFF"

### ■ Customizing the key color

You can set the key illumination color.

#### 1 Touch **Key Colour** on the Display screen.

#### 2 Touch the desired color.

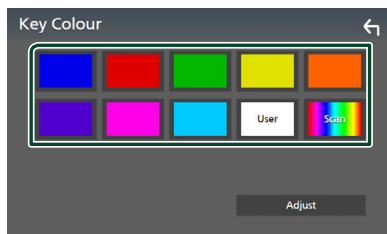

#### ■ **User**

The color you have set in the process of **Adjust** is registered.

#### ■ **Scan**

You can set the key color to continuously scan through the color spectrum.

#### 3 Touch .

#### **To register an original color**

You can register your original color.

#### 1 Touch **User** on the Key Color screen.

#### 2 Touch **Adjust**.

#### 3 Use **—** and **+** to adjust each color value.

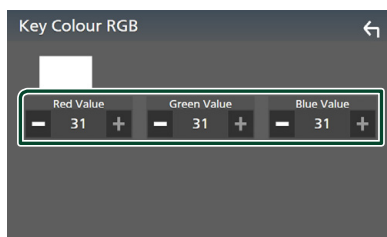

#### 4 Touch .

## Setup

### Change the wallpaper image or color

- 1 Touch **Wallpaper Customize** on the Display screen.
- 2 Select an image.

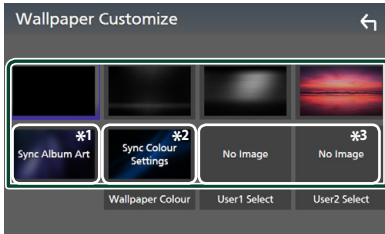

\*1 The album art currently being displayed is used as a wallpaper.

\*2 Select a wallpaper color in advance.

\*3 Select an original image in advance.

### To select wallpaper color

- 1 Touch **Wallpaper Colour** on the Background screen.
- 2 Select a wallpaper color.

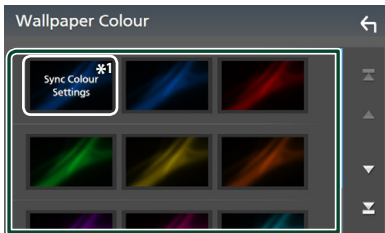

\*1 The color you have selected at **Key Colour** is added on the image. If you select "Scan" at **Key Colour**, you cannot select this image.

- 3 Touch .

### To register an original image

You can load an image from the connected USB device and set it as the wallpaper image. Before starting this procedure, it is necessary to connect the device which has the image to load.

- 1 Touch **User1 Select** or **User2 Select** on the Wallpaper Customize screen.
- 2 Select the image to load.

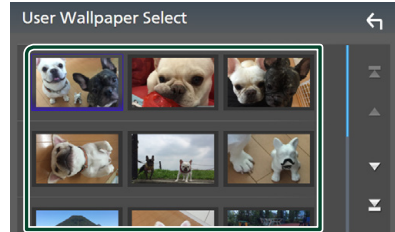

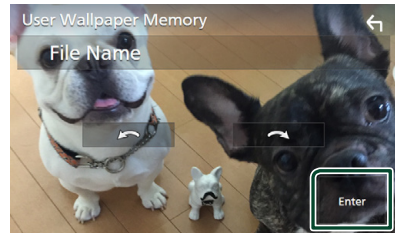

- 3 Touch **Enter**.



► The selected image is loaded and the display returns to the Wallpaper Customize screen.

### NOTE

- Touching  rotates the image counter-clockwise.
- Touching  rotates the image clockwise.
- Picture files: JPEG (.jpg, .jpeg), PNG (.png), BMP (.bmp)

## AV Setup

You can set AV parameters.

### 1 Press the **MENU** button.

- Pop-up menu appears.

### 2 Touch **SETUP**.

- SETUP screen appears.

### 3 Touch **AV**.

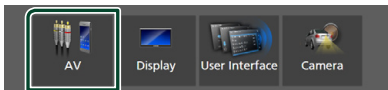

- AV screen appears.

### 4 Set each parameter as follows.

#### ■ **Android Auto Device Select** (DDX919WS / DDX9019DABS / DDX9019S / DMX8019DABS)

Select the device to be used in the Android Auto mode. (P.72)

#### ■ **Apple CarPlay Device List** (Except DMX8019S)

Select the device to be used in the Apple CarPlay mode. (P.29)

#### ■ **Speech Quality Adjust**

Adjust the speech quality.

**Microphone Level** : Adjust the level of microphone gain. Default is "0".

**Echo Cancel Level** : Adjust the level of echo cancellation. Default is "0".

**Noise Reduction Level** : Reduce the noise generated in the surrounding environment without changing the microphone volume. Use this function when the voice of caller is not clear. Default is "0".

#### ■ **iPod Bluetooth Connection** (Except DMX8019S)

See **Select the method of making connections for outputting sound from the iPod source** (P.38).

#### ■ **TV Tuner Control**

Sets when connecting the TV tuner to AV-IN input terminal.

To use this function, it is necessary to set "AV-IN" to "None" in **Camera Assignment Settings**. (P.61)

**ON** : Set to ON when connecting the 3rd party TV tuner. AV-IN Name is set to TV. If you connect the TV tuner made by DOS and watch TV, you can perform some simple operations by touching the screen of this unit.

**OFF** (Default): Set to OFF when not connecting the 3rd party TV tuner.

#### ■ **AV-OUT**

You can select an AV source to be output from the AV OUTPUT port.

OFF, AV-IN, DISC (Except DMX8019DABS / DMX8019S), USB or iPod

- You cannot select AV-IN if the AV-IN input terminal is used for camera.
- You cannot select iPod if it is connected via Bluetooth.
- If you select USB, iPod, DISC (Music CD/Disc media), Spotify or Bluetooth audio as the main source, you cannot select USB or iPod as the AV output source.
- If you select Wireless Mirroring, Apple CarPlay or Android Auto as the main source, you cannot select DISC (Music CD/Disc media), USB or iPod as the AV output source.

#### ■ **Driving Position**

Select the driving position (left or right).

"Left"/"Right" (Default)

#### ■ **Wi-Fi SETUP (Except DMX8019S)**

You can change the device name and display the device address, password. See **Change the device name** (P.72).

## Setup

### **Select an Android device** (DDX919WS / DDX9019DABS / DDX9019S / DMX8019DABS)

- 1 Touch **Android Auto Device Select** on the AV screen.
- 2 Select an Android device.

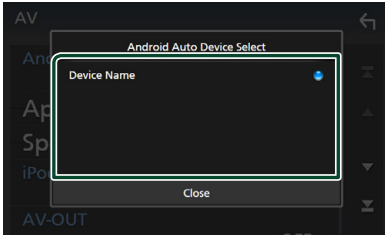

### **Change the device name**

- 1 Touch **Wi-Fi SETUP** on the AV screen.
- 2 Touch **Device Name**.
  - Change Device Name screen appears.
- 3 Touch and hold .
- 4 Input the device name.



- 5 Touch **Enter**.

# Controlling Audio

You can adjust various settings such as audio balance or subwoofer level.

## 1 Press the **MENU** button.

- Pop-up menu appears.

## 2 Touch **Audio**.

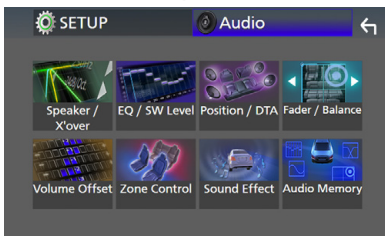
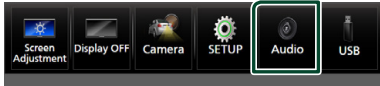

See the following section for each setting.

- Set up speaker / X'over (P.74)
- Controlling equalizer (P.76)
- Set listening position / DTA (P.80)
- Controlling general audio (Fader / Balance) (P.76)
- Set volume offset (P.77)
- Performing zone control (P.78)
- Set sound effect (P.79)
- Memory/recall the audio settings (P.81)

## 3-way speaker system setup

Select the appropriate crossover network mode for the speaker system used (2-way or 3-way speaker system).

## 1 Press the **HOME** button.

- HOME screen appears.

## 2 Touch .

- Source selection screen appears.

## 3 Touch **STANDBY**.

## 4 Press the button ① followed by the button ② for 1 second at the same time.

**WS**

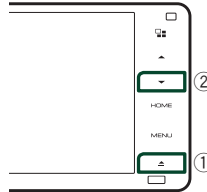

**9019**



**8019**



- Speaker system select screen appears.

## 5 Select the crossover network mode.

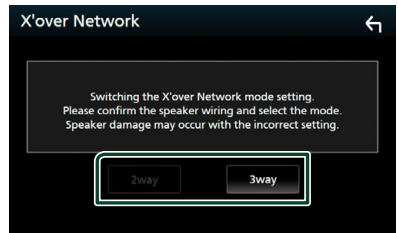

- A confirmation screen appears.

## 6 Touch **Yes**.

### NOTE

- When the 3-way speaker system is selected, the following functions are disabled.
  - Front focus of Listening Position / DTA
  - Fader for Controlling General Audio
  - Zone Control
  - Selection of the speakers to output sound from the cell-phone of Bluetooth HF/Audio
  - Beep for User Interface Setup
- Connecting 3-way speakers with the 2-way mode selected can break the speakers.

## Speaker / X'over setup

**1 Press the MENU button.**

➤ Pop-up menu appears.

**2 Touch Audio.**

➤ Audio screen appears.

**3 Touch Speaker / X'over.**

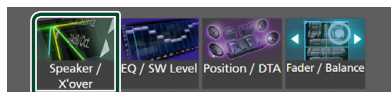

**4 Select a car type.**

You can select the car type and speaker network, etc.

When you select your car type, the Delay Time Alignment is activated automatically (for timing adjustment of sound output for each channel) to have the highest surround effects.



**5 Touch the speaker (1) you wish to adjust and set each parameter (2) as follows.**

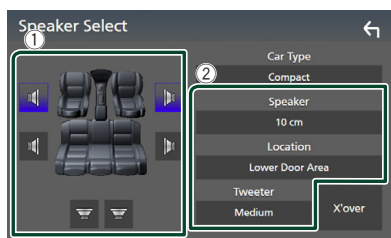

**■ Speaker**

You can select a speaker type and its size to get the best sound effects.

When the speaker type and size are selected, the speaker crossover network is set automatically.

**■ Location (Only for Front, Rear)**

Select the speaker position you have installed.

**■ Tweeter (Only for Front)**

You can set up the tweeter when you are selecting front speakers.

None, Small, Medium, Large

**■ X'over**

Display the speaker crossover setup screen.

You can adjust the crossover frequency that was set automatically when you selected the speaker type.

For details, see **Crossover network setup (P.75)**

**When Speaker network is set to 3-way:**

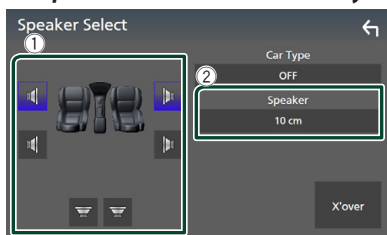

**NOTE**

- For how to switch to the 3-way speaker system, see **3-way speaker system setup (P.73)**. Connecting 3-way speakers with the 2-way mode selected can break the speakers.
- Select "None" if you have no speakers.

## Crossover network setup

You can set the crossover frequency of speakers.

### 1 Touch **X'over**.

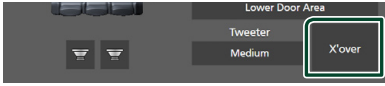

### 2 Touch the speaker to set up.



### 3 Set each parameter as follows.

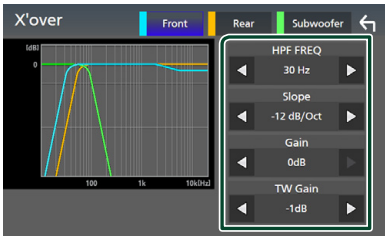

#### ■ **HPF FREQ**

High Pass Filter adjustment. (When Front or Rear is selected on the Speaker Select screen)

#### ■ **LPF FREQ**

Low Pass Filter adjustment. (When Subwoofer is selected on the Speaker Select screen)

#### ■ **Slope** \*1

Set a crossover slope.

#### ■ **Gain**

Adjust the gain of the front speaker, rear speaker, or subwoofer.

#### ■ **TW Gain** \*2

Adjust the tweeter level. (When Front is selected on the Speaker Select screen)

#### ■ **Phase Inversion** \*3

Set the phase of subwoofer output.

Check **Phase Inversion** to shift the phase 180 degrees. (When Subwoofer is selected on the Speaker Select screen)

\*1 Only when "LPF FREQ"/"HPF FREQ" is set to a mode other than "Through" in **X'over**.

\*2 Only when "Tweeter" is set to "Small", "Medium", "Large" in **Speaker Setup**.

\*3 Only when "Subwoofer" is set to a mode other than "None" in **Speaker Setup**.

## When Speaker network is set to 3-way:

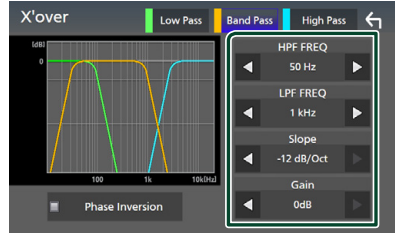

#### ■ **FREQ (High Pass)**

High Pass Filter adjustment.

#### ■ **HPF FREQ, LPF FREQ (Band Pass)**

Band Pass Filter adjustment. (When Mid Range Speaker is selected on the Speaker Select screen)

#### ■ **FREQ (Low Pass)**

Low Pass Filter adjustment. (When Woofer is selected on the Speaker Select screen)

#### ■ **Slope** \*1 \*2

Set a crossover slope.

#### ■ **Gain**

Set the gain of each speaker.

#### ■ **Phase Inversion**

Set the phase of tweeter, mid range, and woofer output.

Check **Phase Inversion** to shift the phase 180 degrees.

\*1 Only when "LPF FREQ"/"HPF FREQ" (Band Pass) is set to a mode other than "Through" in **X'over**.

\*2 Only when "FREQ" (Low Pass) is set to a mode other than "Through" in **X'over**.

### NOTE

- For how to switch to the 3-way speaker system, see **3-way speaker system setup (P.73)**. Connecting 3-way speakers with the 2-way mode selected can break the speakers.

## Controlling General Audio

- 1 Press the **MENU** button.
  - Popup menu appears.
- 2 Touch **Audio**.
  - Audio screen appears.
- 3 Touch **Fader / Balance**.

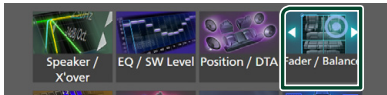

- 4 Set each parameter as follows.

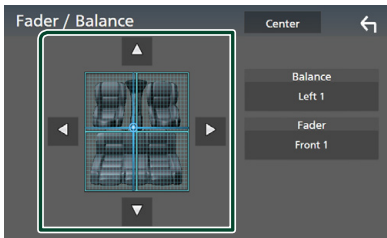

### ■ Fader / Balance

Adjust the volume balance around the touched area.

◀ and ▶ adjust the right and left volume balance.

▲ and ▼ adjust the front and rear volume balance.

### ■ Center

Clear the adjustment.

## Equalizer Control

You can adjust equalizer by selecting the optimized setting for each category.

- 1 Press the **MENU** button.
  - Popup menu appears.
- 2 Touch **Audio**.
  - Audio screen appears.
- 3 Touch **EQ / SW Level**.



- 4 Touch the screen and set the **Graphic Equalizer** as desired.

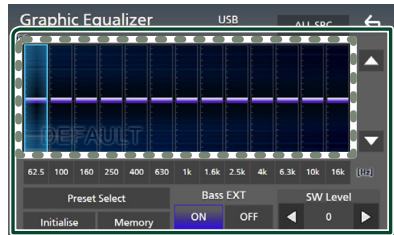

### ■ Gain level (area in dotted frame)

Adjust the gain level by touching each frequency bar.

You can select a frequency bar and adjust its level by ▲, ▼.

### ■ Preset Select

Display the screen for selecting the preset equalizer curve. (P.77)

### ■ Memory

Saves the adjusted equalizer curve as "User1" to "User4". (P.77)

### ■ Initialise

Initialize (flatten) the current EQ curve.

### ■ ALL SRC

Apply the adjusted equalizer curve to all sources. Touch **ALL SRC** and then touch **OK** on the confirmation screen.

### ■ Bass EXT (Bass Extend Settings)

When turned on, the frequencies lower than 62.5 Hz is set to the same gain level (62.5 Hz).



### ■ SW Level

Adjust the subwoofer volume. This setting is not available when Subwoofer is set to "None". See **Speaker / X'over setup (P.74)**.

## ■ Recall the EQ curve

- 1 Touch **Preset Select**.
- 2 Select an EQ curve.

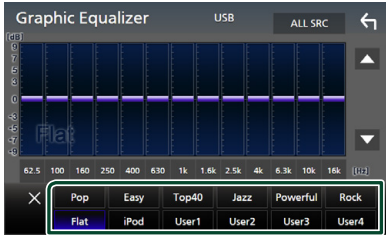

### NOTE

- **iPod** is available for the iPod, Apple CarPlay, and Spotify sources and it is connected via USB.

## ■ Save the EQ curve

- 1 Adjust the EQ curve.
- 2 Touch **Memory**.
- 3 Select where to save.

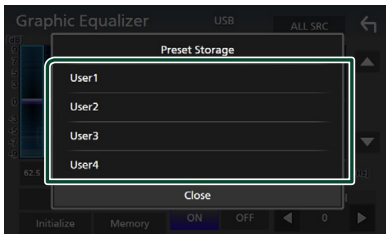

## Volume Offset

Finely adjust the volume of the current source to minimize the difference in volume between different sources.

- 1 Press the **MENU** button.
  - Popup menu appears.
- 2 Touch **Audio**.
  - Audio screen appears.
- 3 Touch **Volume Offset**.

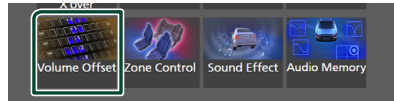

- 4 Touch **+ or -** to adjust the level.

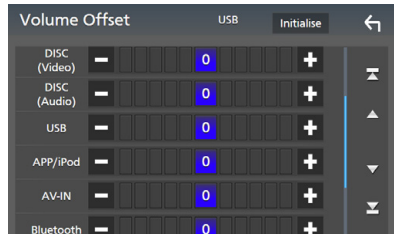

### ■ Initialise

Returns to the initial settings.

### NOTE

- If you have increased the volume first, then reduce the volume using "Volume Offset". Switching the current source to another source suddenly may output extremely loud sound.

## Zone Control

You can select different sources for front and rear positions in the vehicle.

### 1 Press the **MENU** button.

- Popup menu appears.

### 2 Touch **Audio**.

- Audio screen appears.

### 3 Touch **Zone Control**.

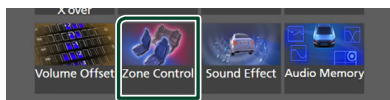

- Zone Control screen appears.

### 4 Touch **Zone Select**.

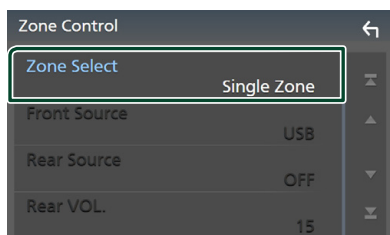

### 5 Touch **Dual Zone**.

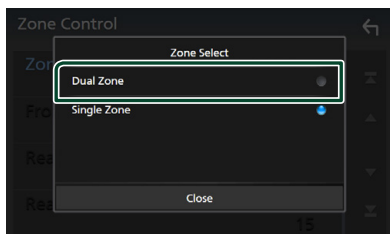

### 6 Set each source as follows.

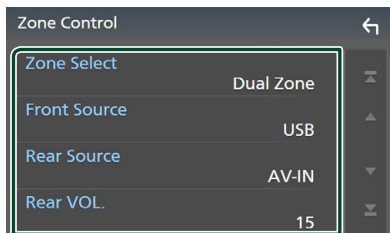

### ■ **Zone Select**

Touch **Single Zone** to turn off the dual zone function.

### ■ **Front Source, Rear Source**

Select an audio source for each.

Rear Source;

"AV-IN"/"DISC"/"iPod"/"USB"/"OFF"

### ■ **Rear VOL.**

Adjust the rear source volume.

### NOTE

- When the rear speaker sound is switched, the audio source that is output at the AV OUTPUT terminal is also switched to the same source.
- When the dual zone function is set to on, the following functions are not available.
  - Output from the subwoofer
  - Subwoofer Level/Bass Boost (**P.79**)
  - Equalizer Control/Sound Effect/Listening Position (**P.76, 79, 80**)
  - Speaker Setup (**P.74**)
  - High-resolution Sound Source File Playback
- You cannot select AV-IN if the AV-IN input terminal is used for camera.
- You cannot select iPod if it is connected via Bluetooth.
- If you select Radio, USB, iPod, Disc (Music CD/Disc media), Spotify or Bluetooth audio as the Front Source, you cannot select USB, iPod, DISC (Music CD/Disc media) as the Rear Source.
- If you select Wireless Mirroring, Apple CarPlay or Android Auto as the Front Source, you cannot select DISC (Music CD/Disc media), USB or iPod as the Rear Source.

## Sound Effect

You can set sound effects.

- 1 Press the **MENU** button.
  - Popup menu appears.
- 2 Touch **Audio**.
  - Audio screen appears.
- 3 Touch **Sound Effect**.

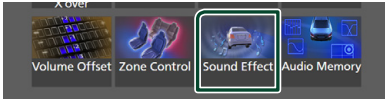

- 4 Set each parameter as follows.

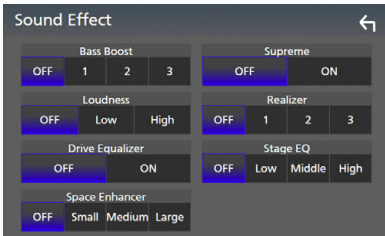

### ■ Bass Boost

Set the amount of bass boost "OFF"/"1"/"2"/"3".

### ■ Loudness

Set the amount of boost of low and high tones.

"OFF", "Low", "High"

### ■ Drive Equalizer

Reduces the driving noise by raising the bandwidth.

"OFF", "ON"

### ■ Space Enhancer

Select the feeling of sound space enhancement.

"OFF"/"Small"/"Medium"/"Large".

This setting is not available for the Radio source.

### ■ Supreme

Turn ON/OFF the Supreme function.

Technology to extrapolate and supplement with proprietary algorithm, the high-frequency range that is cut off when encoding.

### ■ Realizer

Virtually make the sound more realistic using the Digital Signal Processor (DSP) system.

Select the level from "OFF"/"1"/"2"/"3".

### ■ Stage EQ

You can adjust the height of speakers virtually to suit your listening position.

"OFF"/"Low"/"Middle"/"High".

## Listening Position / DTA

Listening Position / DTA allows you to improve the sound field depending on the position of the seat you sit.

Listening Position / DTA allows you to set "Listening Position" and "Front Focus". You cannot set both at the same time.

- 1 Press the **MENU** button.
  - Pop up menu appears.
- 2 Touch **Audio**.
  - Audio screen appears.
- 3 Touch **Position / DTA**.



- Set up Listening Position (**P.80**)
- Set up Front Focus (**P.80**)

### Listening Position

Adjust the sound delay time so that the sounds from different speakers arrive at the listener sitting on the selected seat at the same time.

- 1 Touch **Listening Position** on the Position / DTA screen.
- 2 Select a listening position from **Front R** (Right front), **Front L** (Left front), **Front All** (All front), and **All**.

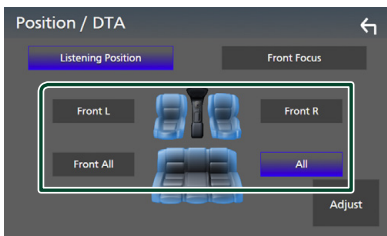

### Position DTA control

You can fine-adjust your listening position.

- 1 Touch **Adjust**.
- 2 Touch **Delay**.

- 3 Touch **◀** or **▶** to adjust the delay time of the selected speaker.



- 4 Touch **Level**.
- 5 Touch **◀** or **▶** to adjust the sound level of the selected speaker.



### NOTE

- To initialize the Delay and Level settings, touch **Initialise** and **YES** on the confirmation screen.

### Front Focus

You can focus the imaginary sound image on the front of the selected seat.

- 1 Touch **Front Focus** in the Position / DTA screen.
- 2 Select a front focus position.

For **Front All** and **All**, select Priority L or R depending on which side you want to put the imaginary sound image.

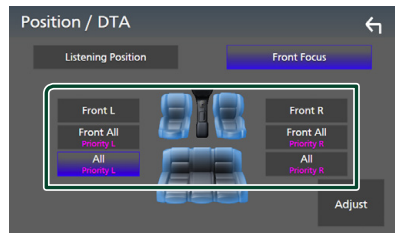

## Front Focus fine adjustment

- 1 Touch **Adjust**.
- 2 Touch **Delay**.
- 3 Set each parameter as follows.

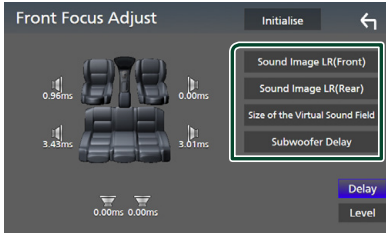

### ■ Sound Image LR (Front)

Focus the sound image on the front of front seats.

### ■ Sound Image LR (Rear)

Focus the sound image on the front of rear seats.

### ■ Size of the Virtual Sound Field

Adjust the size of sound image to meet your taste. If the sound image is shifted from the front, move it back by **Sound Image LR (Front)** or **Sound Image LR (Rear)**.

### ■ Subwoofer Delay

Adjust the delay time of subwoofer sound.

## 4 Touch **Level**.

## 5 Touch ◀ or ▶ to adjust the sound level of the selected speaker.



### NOTE

- To initialize the Delay and Level settings, touch **Initialise** and **YES** on the confirmation screen.

## Audio Setup memory

Audio Control settings can be memorized. The memorized settings can be recalled at any time.

- 1 Press the **MENU** button.
  - Popup menu appears.
- 2 Touch **Audio**.
  - Audio screen appears.
- 3 Touch **Audio Memory**.

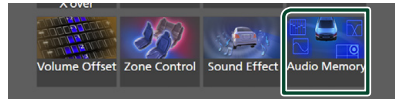

### ■ **SETUP Memory**

Lock or unlock the Audio SETUP Memory/Recall/Clear.

### ■ **Audio SETUP Memory**

Memorize the current audio settings.

- Fader / Balance, Speaker / X'over, Equalizer (User Preset, SW Level), Position / DTA, Sound Effect (**P.73**)

### ■ **Audio SETUP Recall**

Recall the memorized audio setting.

### ■ **Audio SETUP Clear**

Clear the Audio SETUP Memory and the currently memorized audio settings.

# Remote control

This unit can be operated using the remote control.

## ⚠ CAUTION

- Put the remote control in a place where it will not move during braking or other operations. A dangerous situation could result, if the remote control falls down and gets wedged under the pedals while driving.
- Do not leave the battery near fire or under direct sunlight. A fire, explosion or excessive heat generation may result.
- Do not recharge, short, break up or heat the battery or place it in an open fire. Such actions may cause the battery to leak fluid. If spilled fluid comes in contact with your eyes or on clothing, immediately rinse with water and consult a physician.
- Place the battery out of reach of children. In the unlikely event that a child swallows the battery, immediately consult a physician.

## Battery Installation

If the remote control operates only over shorter distances or does not operate at all, it is possible that the batteries are depleted.

In such instances, replace the both batteries with new ones.

- 1 Insert two “AAA”/“R03”-size batteries with the ⊕ and ⊖ poles aligned properly, following the illustration inside the case.

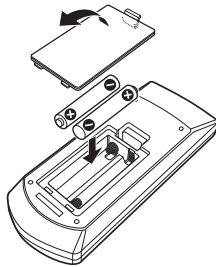

## Functions of the Remote control Buttons

### ■ Switch the operation mode

The functions operated from the remote control differ depending on the position of the mode switch.

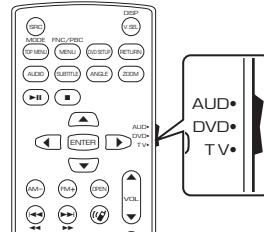

#### ■ AUD mode

Switch to this mode when controlling a selected source or tuner source, etc.

#### ■ DVD mode

Switch to this mode when playing a disc media including DVD, VCD, and CD.

#### ■ TV mode

Not used.

### NOTE

- When controlling a player that is not integrated in the unit, select “AUD” mode.

### ■ Direct search mode

Using the remote control, you can jump directly to the desired file, track chapter, etc. by entering the number corresponding to the content.

### NOTE

- This operation cannot be performed for the USB device and iPod.

- 1 Press the **DIRECT** button several times until the desired content appears.

The available contents are different depending on the source type.

■ DVD

Title number/Chapter number

■ VCD 1.X and 2.X (PBC OFF)

Track number

■ VCD 2.X (PBC ON)

Scene number/Track number

■ Music CD

Track number

■ Radio

Frequency value

**2** Enter the number of the content you want to play using the numeric keypad.

**3** For DVD or VCD, music CD, press the **ENTER** button.

For radio, press the **◀◀** or **▶▶** button.

▶ The content corresponding to the number you entered is played.

■ Basic Operation

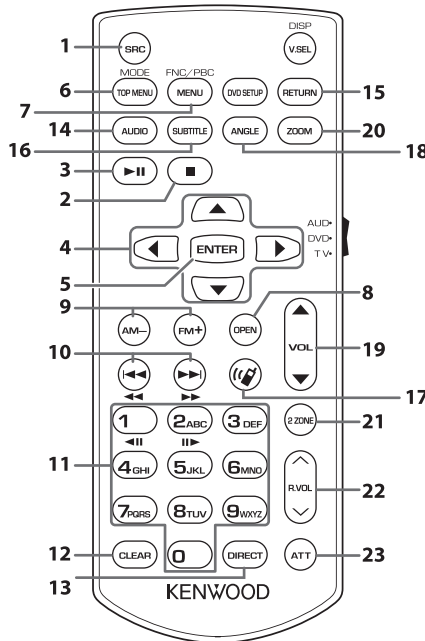

	Key Name	Mode switch	Function
1	SRC	–	Switches to the source to be played. In hands-free mode, hangs up the phone.
2	■	DVD	Stops playing and memorizes the last point where the disc stopped. The last point is deleted by pressing twice.
3	▶	–	Pauses the track or file, and resumes playing by pressing twice. For the Radio and Digital Radio (DDX9019DABS / DMX8019DABS) sources in AUD mode, switches the seek mode.
4	▲/▼/◀/▶	DVD	Moves the cursor in the DVD menu.
5	ENTER	–	Performs the selected function.
6	TOP MENU	AUD	Screen mode changes each time you press this key during video playback.
		DVD	Returns to the DVD top menu.

## Remote control

	Key Name	Mode switch	Function
<b>7</b>	MENU	AUD	Displays the control screen of current source. (USB, iPod, DISC)
		DVD	Displays the DVD menu. Turns the playback control on or off while playing VCD.
<b>8</b>	OPEN	–	Switches the display angle each time it is pressed. ( <b>LWS</b> / <b>9019</b> )
<b>9</b>	AM-/FM+	AUD	Selects the folder to be played. For the Radio and Digital Radio (DDX9019DABS / DMX8019DABS) sources in AUD mode, selects FM/AM band to be received. For the DVD source in DVD mode, selects the title to be played.
<b>10</b>		–	Selects the track or file to be played. For the Radio, Digital Radio (DDX9019DABS / DMX8019DABS) sources in AUD mode, switches to broadcast stations received by the unit. For the DVD/VCD source in DVD mode, selects the chapter/scene/track to be played.
<b>11</b>	Numeric Keypad	AUD	Specifies the number to search in direct search. <b>(P.82)</b> . For the Radio and Digital Radio sources, allows you to enter the preset number. <ul style="list-style-type: none"> <li>• If the preset number is one digit, press the number.</li> <li>• If the preset numbers is two digits, press continuously the numbers within 3 seconds.</li> <li>• Pressing <b>◀▶</b> within 3 seconds allows you to determine the preset number of one digit.</li> </ul>
		DVD	Press <b>1 2</b> to fast forward/backward. Press <b>4 5</b> to slow forward/backward. Switches the slow playback speed each time you press this key.* (*DVD only)
<b>12</b>	CLEAR	DVD	Clears the number.
<b>13</b>	DIRECT	–	Switches to the direct search mode. <b>(P.82)</b> .
<b>14</b>	AUDIO	DVD	Switches the voice language each time you press this key.
<b>15</b>	RETURN	DVD	Displays previous screen.
<b>16</b>	SUBTITLE	DVD	Switches the subtitle language.
<b>17</b>		–	When a call comes in, answers the call.
<b>18</b>	ANGLE	DVD	Switches the picture angle each time you press this key.
<b>19</b>	VOL ▲▼	–	Adjusts the volume.
<b>20</b>	ZOOM	DVD	Switches the zoom ratio (2, 3, 4, Off) each time you press this key.
<b>21</b>	2 ZONE	–	Switches the Dual Zone function on and off.
<b>22</b>	R.VOL	–	Adjusts volume at rear when the Dual Zone function is on.
<b>23</b>	ATT	–	Lowers the volume by pressing the key once.
		–	Restores the previous volume by pressing the key twice.



# Connection/Installation

## Before Installation

Before installation of this unit, please note the following precautions.

### ▲ WARNINGS

- If you connect the ignition wire (red) and the battery wire (yellow) to the car chassis (ground), you may cause a short circuit, that in turn may start a fire. Always connect those wires to the power source running through the fuse box.
- Do not cut out the fuse from the ignition wire (red) and the battery wire (yellow). The power supply must be connected to the wires via the fuse.

### ▲ CAUTION

- Install this unit in the console of your vehicle. Do not touch the metal part of this unit during and shortly after the use of the unit. Metal part such as the heat sink and enclosure become hot.

### NOTE

- Mounting and wiring this product requires skills and experience. For best safety, leave the mounting and wiring work to professionals.
- Make sure to ground the unit to a negative 12V DC power supply.
- Do not install the unit in a spot exposed to direct sunlight or excessive heat or humidity. Also avoid places with too much dust or the possibility of water splashing.
- Do not use your own screws. Use only the screws provided. If you use the wrong screws, you could damage the unit.
- If the power is not turned ON ("There is an error in the speaker wiring. Please check the connections." is displayed), the speaker wire may have a short-circuit or touched the chassis of the vehicle and the protection function may have been activated. Therefore, the speaker wire should be checked.
- If your car's ignition does not have an ACC position, connect the ignition wires to a power source that can be turned on and off with the

ignition key. If you connect the ignition wire to a power source with a constant voltage supply, such as with battery wires, the battery may be drained.

- If the console has a lid, make sure to install the unit so that the front panel will not hit the lid when closing and opening.
- If the fuse blows, first make sure the wires aren't touching to cause a short circuit, then replace the old fuse with one with the same rating.
- Insulate unconnected wires with vinyl tape or other similar material. To prevent a short circuit, do not remove the caps on the ends of the unconnected wires or the terminals.
- Connect the speaker wires correctly to the terminals to which they correspond. The unit may be damaged or fail to work if you share the ⊖ wires or ground them to any metal part in the car.
- When only two speakers are being connected to the system, connect the connectors either to both the front output terminals or to both the rear output terminals (do not mix front and rear). For example, if you connect the ⊕ connector of the left speaker to a front output terminal, do not connect the ⊖ connector to a rear output terminal.
- After the unit is installed, check whether the brake lamps, blinkers, wipers, etc. on the car are working properly.
- Mount the unit so that the mounting angle is 30° or less.
- This unit has the cooling fan to decrease the internal temperature. Do not mount the unit in a place where the cooling fan of the unit is blocked. Blocking these openings will inhibit the cooling of the internal temperature and result in malfunction.

## Connection/Installation

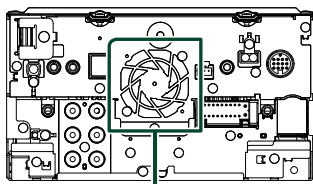



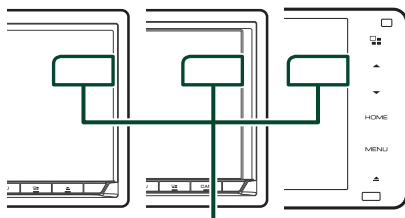

Cooling fan





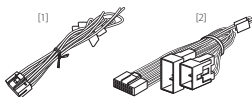

- Do not press hard on the panel surface when installing the unit to the vehicle. Otherwise scars, damage, or failure may result.
- Reception may drop if there are metal objects near the Bluetooth antenna.

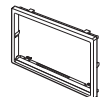

Bluetooth antenna unit

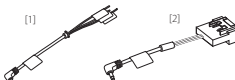
### Supplied accessories for installation

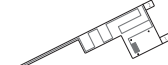
①		x1
②	 (Black 1 m)	x1
③	 (Gray 1 m)	x1
④	 (3 m)	x1
⑤	 (M5 x 8 mm)	x6

⑥	 (M5 x 8 mm)	x6
⑦ <sup>[3]</sup>		x1
⑧	 (3.5 m)	x1
⑨		x1
⑩		x1
⑪ <sup>[4]</sup>		x3
⑫ <sup>[4]</sup>		x1
⑬ <sup>[4]</sup>		x1
⑭ <sup>[4]</sup>		x1

<sup>[1]</sup> Indonesia models, **9019**, **8019** only

<sup>[2]</sup> Except Indonesia models, **9019**, **8019**

<sup>[3]</sup> DDX9019DABS / DMX8019DABS / DMX8019S

<sup>[4]</sup> DDX9019DABS / DMX8019DABS

## Installation procedure

- 1) To prevent a short circuit, remove the key from the ignition and disconnect the  $\ominus$  terminal of the battery.
- 2) Make the proper input and output wire connections for each unit.
- 3) Connect the speaker wires of the wiring harness.
- 4) Connect the wiring harness wires in the following order; ground, battery, ignition.
- 5) Connect the wiring harness connector to the unit.
- 6) Install the unit in your car.
- 7) Reconnect the  $\ominus$  terminal of the battery.
- 8) Perform the Initial Setup.  
See **Initial setup (P.8)**.

## Installing the unit

### Japanese cars

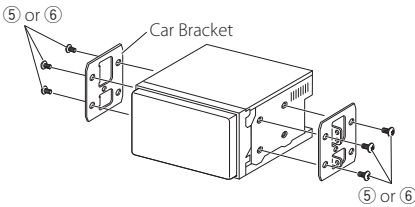

#### NOTE

- Make sure that the unit is installed securely in place. If the unit is unstable, it may malfunction (eg, the sound may skip).

### Trim plate (DDX9019DABS / DMX8019DABS / DMX8019S)

- 1) Attach accessory ⑦ to the unit.

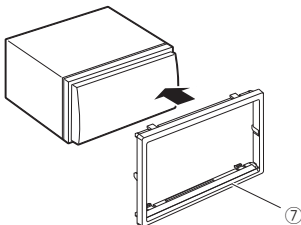

## GPS antenna

GPS antenna is installed inside of the car. It should be installed as horizontally as possible to allow easy reception of the GPS satellite signals.

To mount the GPS antenna inside your vehicle:

- 1) Clean your dashboard or other surface.
- 2) Remove the separator of the metal plate (accessory ⑨).
- 3) Press the metal plate (accessory ⑨) down firmly on your dashboard or other mounting surface. You can bend the metal plate (accessory ⑨) to conform to a curved surface, if necessary.
- 4) Remove the separator of the GPS antenna (accessory ⑧), and stick the antenna to the metal plate (accessory ⑨).

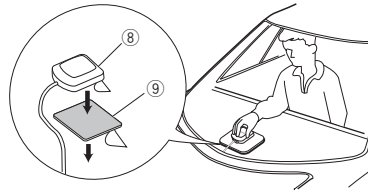

#### NOTE

- Use the supplied GPS antenna. Using the GPS antenna other than the supplied one may cause a drop in positioning accuracy.
- Depending on the type of car, reception of the GPS satellite signals might not be possible with an inside installation.
- Please install this GPS antenna in an area away from any antennas that are used with CB radios or satellite televisions.
- The GPS antenna should be installed at a position that is spaced at least 12 inch (30 cm) from cellular phone or other transmitting antennas. Signals from the GPS satellite may be interfered with by these types of communication.
- Painting the GPS antenna with (metallic) paint may cause a drop in performance.

### Microphone unit

- 1) Check the installation position of the microphone (accessory ④).
- 2) Clean the installation surface.
- 3) Remove the separator of the microphone (accessory ④), and stick the microphone to the place shown below.
- 4) Wire the microphone cable up to the unit with it secured at several positions using tape or other desired method.
- 5) Adjust the direction of the microphone (accessory ④) to the driver.

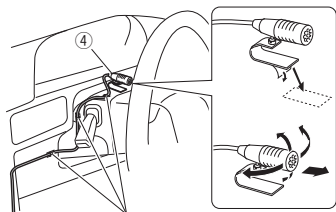

Fix a cable with a commercial item of tape.

### Detaching the trim plate (DDX9019DABS / DMX8019DABS / DMX8019S)

- 1) Detach accessory ⑦ to the unit.

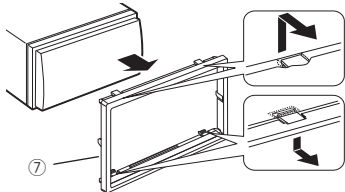

### Installation the Digital Radio antenna (DDX9019DABS / DMX8019DABS)

#### CAUTION

- This film antenna is exclusively for use inside the vehicle.
- Do not install at the following locations:
  - Where it may block driver's view
  - Where it may obstruct operation of safety devices such as air bags
  - On movable glass surface such as rear hatch
  - On the side of the vehicle (e.g. doors, front-side windows)
  - On rear windows

- Signal strength will decrease at the following locations:
  - On IR reflecting glass or where covered with mirror type glass film
  - Where it overlaps with genuine radio antenna (pattern)
  - Where it overlaps with window heating wires
  - When glass that blocks radio signals (e.g. IR reflecting glass, thermal insulation glass) is used
- Poor reception may occur:
  - Due to noise when the windshield wipers, air conditioner, or motor is turned on
  - Depending on the location of the broadcast station in relation to the vehicle (antenna)
- Thoroughly wipe oil and dirt from the pasting surface with the included cleaner (accessory ⑫).
- Do not bend or damage the film antenna (accessory ⑬).
- It may not be possible to install on some type of vehicle.
- Check the cable routing of the film antenna (accessory ⑬) and amplifier (accessory ⑭) before pasting.

#### Installation overview

The antenna should be installed on the passenger side for safety.

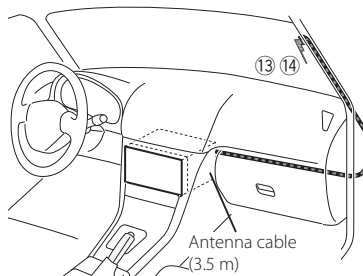

#### Determining the antenna installation location

- The direction of the film antenna (accessory ⑬) changes depending on whether the film antenna is installed on the right side or left side.
- Be sure to check the installation location of the film antenna (accessory ⑬) before installing. The film antenna cannot be reattached.
- Install the antenna at least 100 mm away from other antennas.
- Do not attach the amplifier unit (accessory ⑭) to the ceramic line (black part) around the windscreen, as it will not stick sufficiently.

**When installing the antenna on the right side**

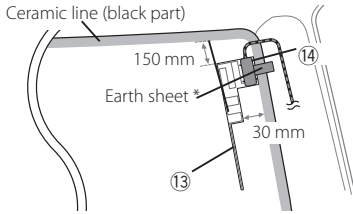

**When installing the antenna on the left side**

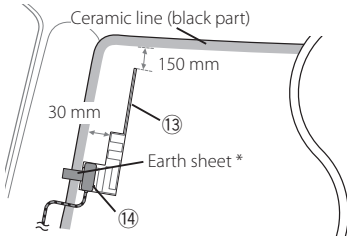

**NOTE**

- \*Where the earth sheet of Amplifier (accessory 14) can be pasted on the metal part of the front pillar.

**CAUTION**

**When installing the antenna cable inside a front pillar that contains an air bag**

- The front pillar cover is secured with a special clip which may need to be replaced when the front pillar cover is removed. Contact your vehicle dealer for details on replacing the front pillar cover and availability of replacement parts.

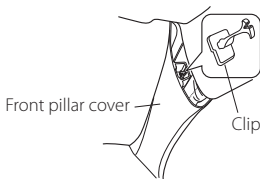

- Install the amplifier unit (accessory 14) above the air bag so that the antenna and the air bag.

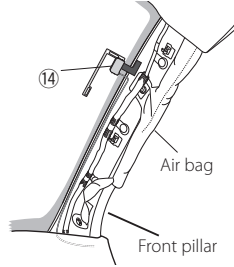

**Determining the antenna installation location**

- 1) Remove the front pillar cover of your car.

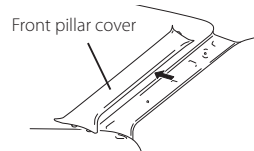

- 2) Clean the windscreen with the supplied cleaner (accessory 12).

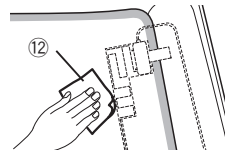

- Wait until the glass surface is completely dry before pasting.
- If the glass surface is cold, such as during winter, warm it with defroster or dryer.

- 3) Remove the first sheet (tag 1) of film antenna (accessory 13) horizontally and paste the antenna on the front glass.

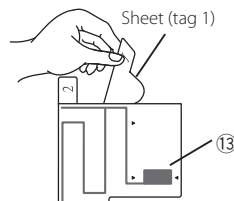

- Do not touch the pasting surface (adhesive side) of the film antenna (accessory 13).

## Connection/Installation

- 4) Rub the film antenna (accessory ⑬) gently in the direction of the arrow shown below to firmly stick it to the windscreen.

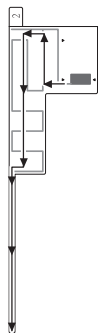

- 5) Remove the second sheet (tag 2) on the film antenna (accessory ⑬) vertically.

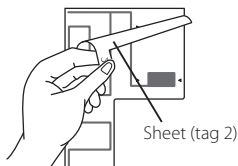

- 6) Match the protrusions of the amplifier unit (accessory ⑭) with the ◀ markings on the film antenna (accessory ⑬) and attach the amplifier.

Do not touch the lead terminal or the adhesive side of the amplifier unit (-).

### When installing the antenna on the right side

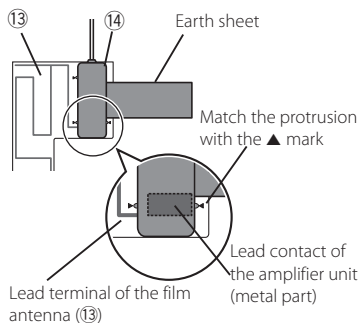

### When installing the antenna on the left side

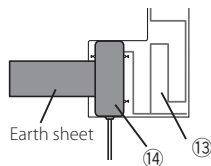

- 7) Remove the film covering the earth sheet and attach the earth sheet to the metal part of the vehicle.

Provide sufficient space for the earth sheet so that it does not obstruct the interior parts (front pillar cover). Also take care that the interior parts do not obstruct the amplifier unit (accessory ⑭).

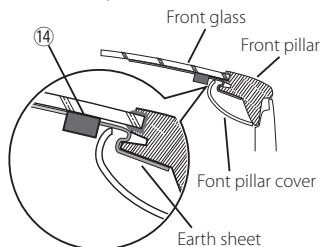

- 8) Wire the antenna cables.  
Use cord clamper (accessory ⑪) to secure the antenna cable to the pillar in several places.
- 9) Reattach the front pillar cover.
- 10) Be sure not to damage the earth sheet and amplifier unit (accessory ⑭) when reattaching.
- 11) Connect the amplifier unit (accessory ⑭) to the DAB input terminal on the rear of the unit.
- 12) Set **Antenna Power** to **ON**. (P.47)

## Connecting wires to terminals

Indonesia models / 9019 / 8019

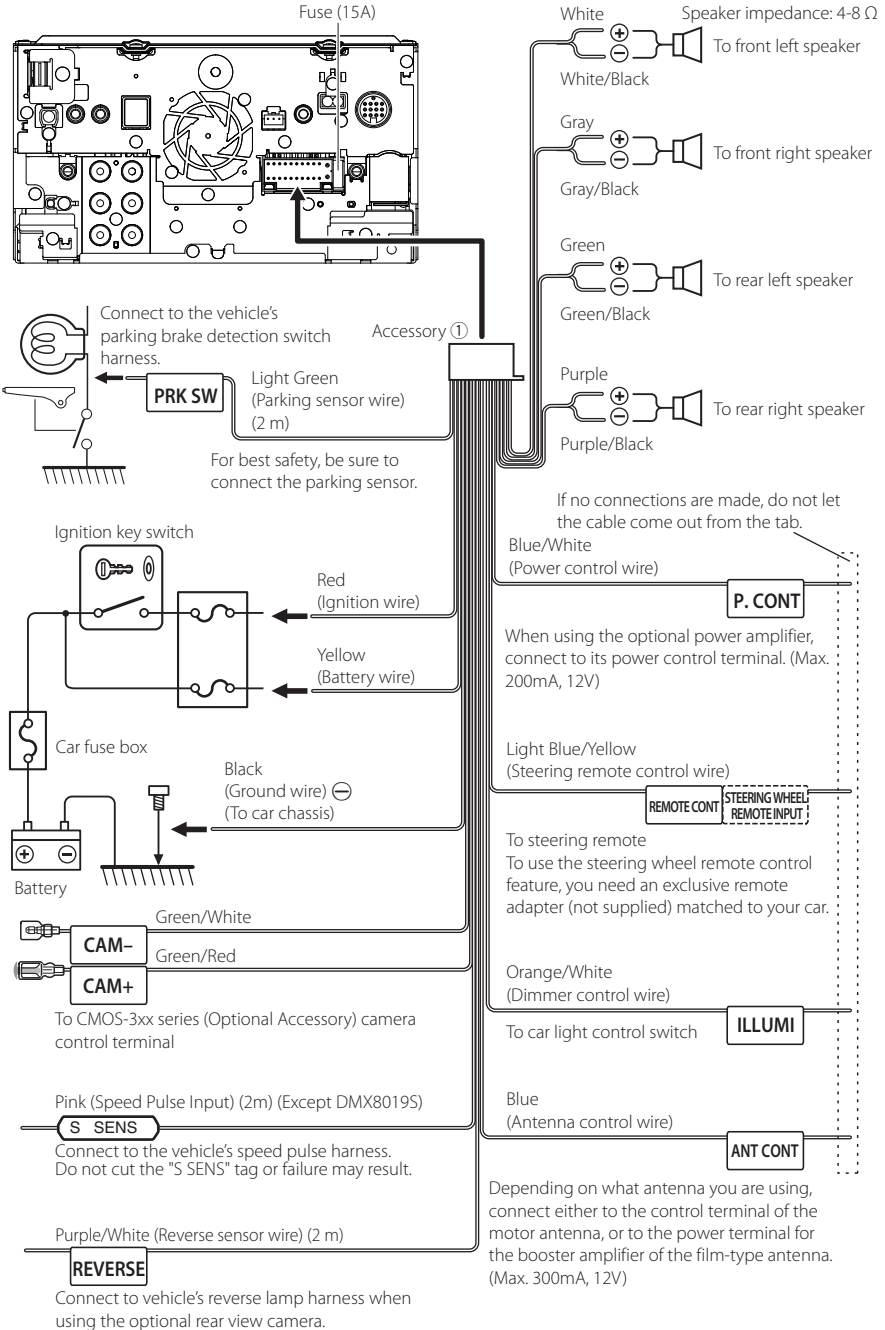

## Connection/Installation

### ● Except Indonesia models, **9019**, **8019**

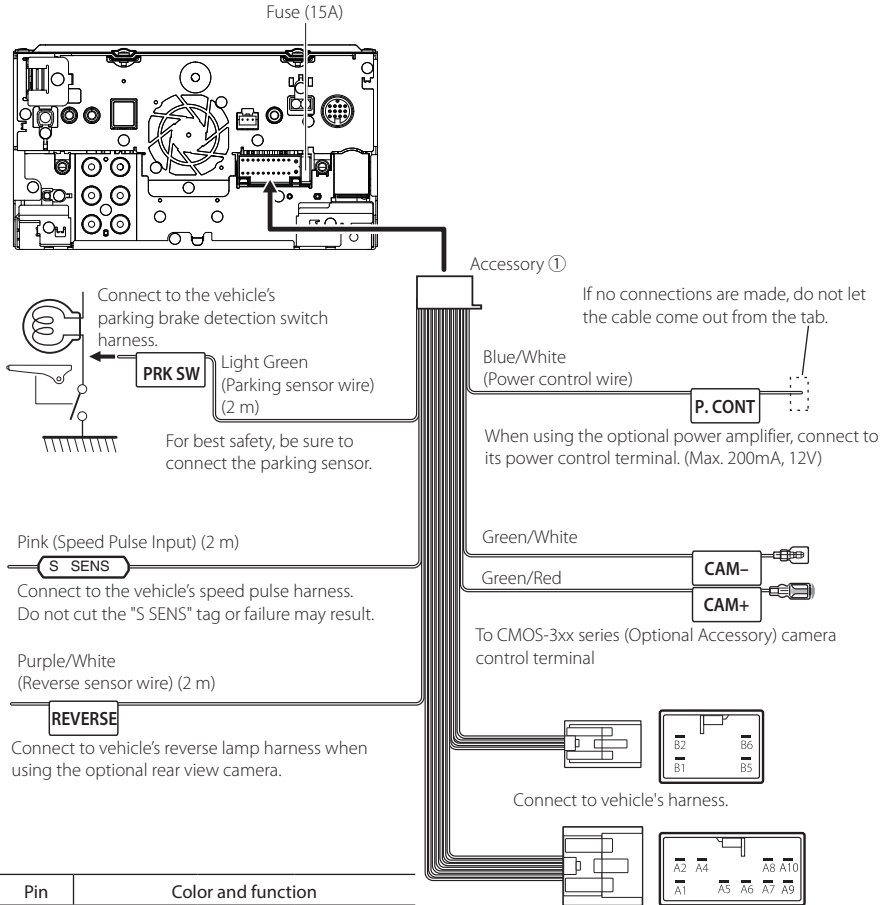

\* Speaker Impedance: 4-8 Ω

<sup>(1)</sup> Max. 300mA, 12V



### 3-way speaker system setup

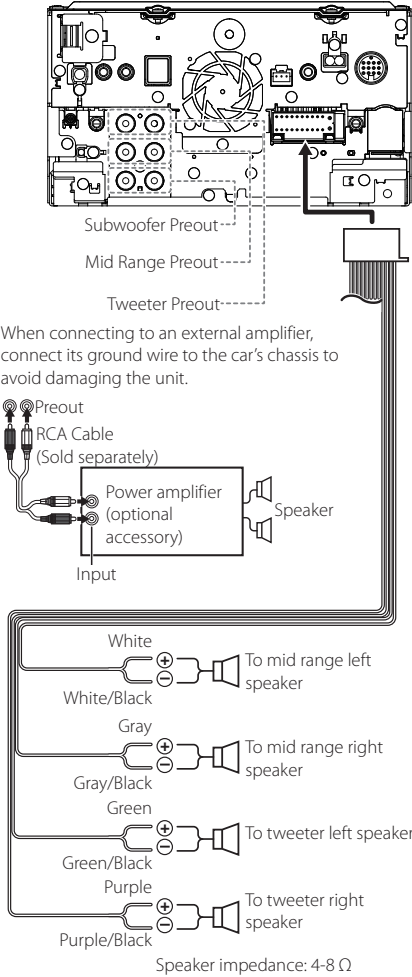

#### NOTE

- For speaker system setup, see **3-way speaker system setup (P.73)**.
- For speaker setup and crossover setup, see **Speaker / X'over setup (P.74)**.
- For how to connect speaker wires to terminals other than speaker terminals and Preout terminals, see **Connecting the system and external components (P.93)** and **Connecting wires to terminals (P.91)**.

### Connecting the system and external components

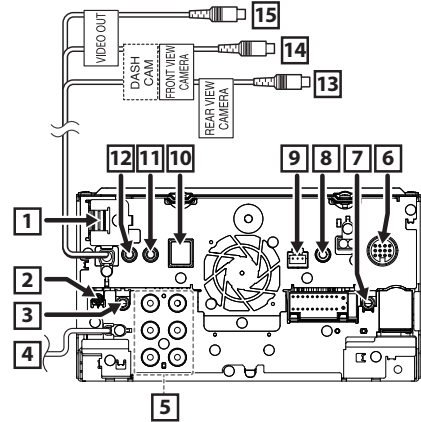

- 1** HDMI input  
(Except DMX8019S)  
Use HDMI cable KCA-HD100 (optional accessory).

When you connect the cable to HDMI terminal, remove the fixture. After connecting the cable, put the fixture again.

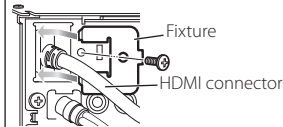

- 2** Accessory **14**: DAB antenna  
(DDX9019DABS / DMX8019DABS only)

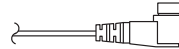

- 3** AV Audio output (ø3.5 mini jack)

- 4** FM/AM antenna input



- 5** When connecting to an external amplifier, connect its ground wire to the car's chassis to avoid damaging the unit.

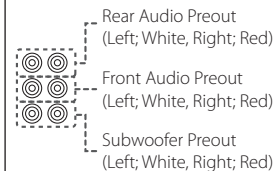

## Connection/Installation

**6** External navigation interface  
(Except Indonesia models and DMX8019DABS)  
Connect a navigation unit KNA-G630 (optional accessory).

**7** TV tuner remote output

**8** This jack accepts either AV-IN (CA-C3AV; Optional Accessory) or Side (Left or Right) View Camera Input.  
For more information, see **To set up the camera assignment settings (P.61)**.

**9** Dashboard camera interface  
Connect a Dashboard Camera DRV-N520 (optional accessory). **(P.96)**

**10** Accessory ⑧: GPS Antenna  
Use the supplied GPS antenna. Using the GPS antenna other than the supplied one may cause a drop in positioning accuracy.

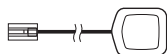

**11** Accessory ④: Bluetooth Microphone

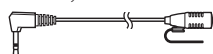

**12** Accessory ⑩: Steering remote harness  
Connect to vehicle's steering remote harness.  
Contact your KENWOOD dealer for details.  
Indonesia models, **9019** , **8019** :

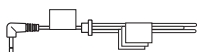

Except Indonesia models, **9019** , **8019** :



Pin	Color and function	
C21	Light green/Red	Input 1
C22	Purple/Red	Input 2
C23	Gray/Red	Ground

**13** Rear view camera input (Yellow)

**14** Front view camera/ Dashboard camera input (Yellow)

**15** Visual Output (Yellow)

## Connecting a USB device

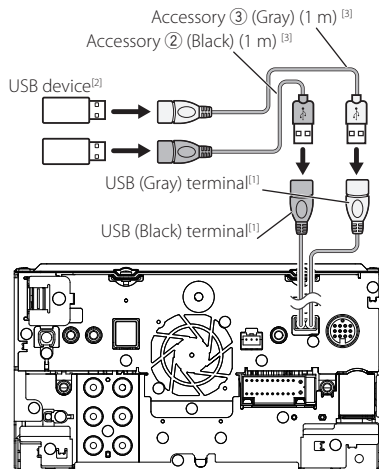

<sup>[1]</sup> USB maximum power supply current :  
DC 5 V  $\overline{\text{---}}$  1.5 A

<sup>[2]</sup> Sold separately

<sup>[3]</sup> See **Securing the USB extension cable (P.94)**.

## Securing the USB extension cable

Secure the USB extension cable with insulating tape or the like so that its connectors are not disconnected.

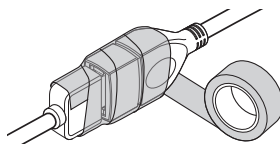

## Connecting an iPod/iPhone

### ● Lightning connector

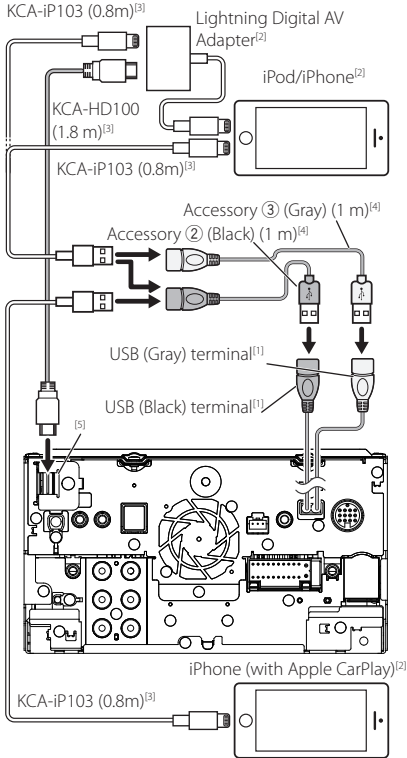

<sup>[1]</sup> USB maximum power supply current :  
DC 5 V  $\equiv$  1.5 A

<sup>[2]</sup> Sold separately

<sup>[3]</sup> Optional accessory

<sup>[4]</sup> See **Securing the USB extension cable (P.94)**.

<sup>[5]</sup> Except DMX8019S

## Connecting an Android smartphone

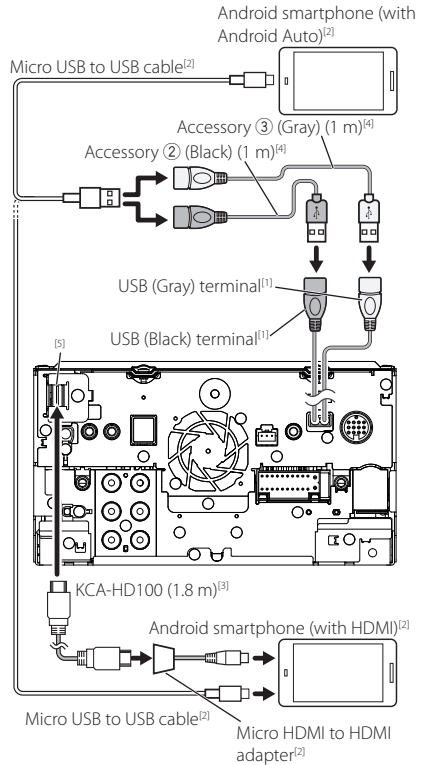

<sup>[1]</sup> USB maximum power supply current :  
DC 5 V  $\equiv$  1.5 A

<sup>[2]</sup> Sold separately

<sup>[3]</sup> Optional accessory

<sup>[4]</sup> See **Securing the USB extension cable (P.94)**.

<sup>[5]</sup> Except DMX8019S

## Connecting the camera

Left Side View Camera and Right Side View Camera <sup>[2]</sup>

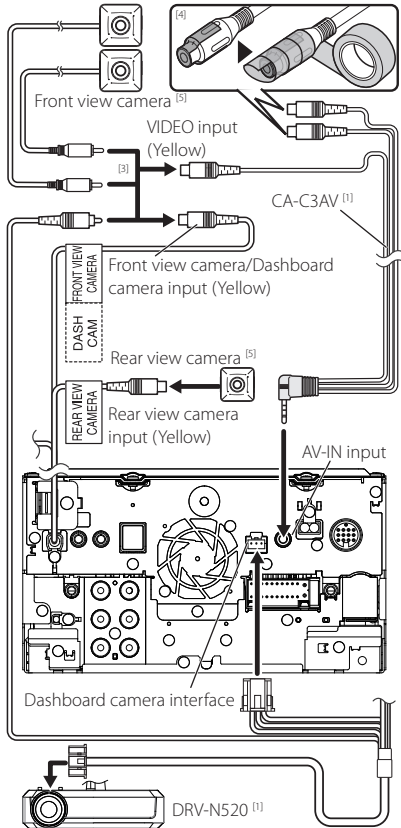

<sup>[1]</sup> Optional accessory

<sup>[2]</sup> Sold separately

<sup>[3]</sup> Up to 2 cameras of Dashboard camera, Front view camera, Left Side View Camera and Right Side View Camera can be connected. For more information, see **Camera Assignment Settings (P.61)**.

<sup>[4]</sup> Insulate audio input terminals of a CA-C3AV (Optional Accessory) when connecting to the Camera.

<sup>[5]</sup> CMOS-3xx series (Optional Accessory) or commercially available camera.

# Troubleshooting

## Problems and Solutions

If any trouble occurs, first check the following table for possible problems.

### NOTE

- Some functions of this unit may be disabled by some settings made on this unit.
- What might seem to be a malfunction in your unit may just be the result of slight misoperation or miswiring.

### About settings

- **Cannot set up the subwoofer.**
- **Cannot set up subwoofer phase.**
- **No output from the subwoofer.**
- **Cannot set up the low pass filter.**
- **Cannot set up the high pass filter.**

Subwoofer is not set to on.

- Set the subwoofer to on. See *Speaker / X'over setup (P.74)*.

The dual zone function is enabled.

- Set the dual zone function to off. See *Zone Control (P.78)*.

- **Cannot select the output destination of the subsource in the dual zone.**
- **Cannot adjust the volume of the rear speakers.**

The dual zone function is disabled.

- Set the dual zone function to on. See *Zone Control (P.78)*.

- **Cannot set up the equalizer.**
- **Cannot set up the crossover network.**

The dual zone function is enabled.

- Set the dual zone function to off. See *Zone Control (P.78)*.

### About audio operations

#### Radio reception is poor.

The car antenna is not extended.

- Pull out the antenna all the way.

The antenna control wire is not connected.

- Connect the wire correctly. See *Connecting the system and external components (P.93)*.

#### Cannot select a folder.

The random play function is enabled.

- Turn off the random function.

#### Cannot perform repeat play during VCD playback.

The PBC function is enabled.

- Turn off the PBC function.

#### The specified disc does not play, but another one plays instead.

The disc is quite dirty.

- Clean the disc. See *Precautions on handling discs (P.4)*.

The disc is severely scratched.

- Try another disc instead.

#### The sound skips when an audio file is being played.

The disc is scratched or dirty.

- Clean the disc. See *Precautions on handling discs (P.4)*.

The recording condition is bad.

- Record the file again or use another disc.

### Others

#### The Touch Sensor Tone doesn't sound.

The preout jack is being used.

- The Touch Sensor Tone cannot be output from the preout jack.

## Error Messages

When you fail to operate the unit correctly, the cause of the failure appears as the message on the screen.

#### There is an error in the speaker wiring. Please check the connections.

Protective circuit has been activated because a speaker cord has shorted or it has come in contact with the car chassis.

- Wire or insulate the speaker cord as appropriate and turn the power off and on again.

#### Hot Error

When the internal temperature of this unit rises to 60°C or more, the protection circuit is activated and you may not be able to operate the unit.

- Use the unit again after reducing the temperature of the unit.

#### Mecha Error

The disc player is malfunctioning.

- Eject the disc and try inserting it again. Contact the KENWOOD dealer if this indicator continues blinking or the disc cannot be ejected.

#### Disc Error

An unplayable disc is inserted.

- Change the disc. See *Playable Media and Files (P.99)*.

## Troubleshooting

---

### Read Error

The disc is quite dirty.

- Clean the disc. See **Precautions on handling discs (P.4)**.

Disc is upside down.

- Load the disc with the labeled side up.
- 

### Region Code Error

The disc you wanted to play has a region code that cannot be played with this unit.

- See **Region Codes in the World (P.101)** or try another disc.
- 

### Error 07–67

The unit is not operating correctly due to some reason or other.

- Turn the power off and on again. If the “Error 07–67” message does not disappear, contact your nearest KENWOOD dealer.
- 

### No Device (USB device)

The USB device is selected as a source although no USB device is connected.

- Change the source to any source other than USB/iPod. Connect a USB device, and change the source to USB again.
- 

### Disconnected (iPod, Bluetooth audio player)

The iPod/Bluetooth audio player is selected as a source although no iPod/Bluetooth audio player is connected.

- Change the source to any source other than iPod/Bluetooth. Connect an iPod/Bluetooth audio player, and change the source to iPod/Bluetooth again.
- 

### No Media file

The connected USB device contains no playable audio file. Media was played that doesn't have data recorded that the unit can play.

- See **Playable Media and Files (P.99)** and try another USB device.
- 

### USB device over current status detected.

The connected USB device is rated a current capacity higher than the allowable limit.

- Check the USB device. Some trouble may have occurred to the connected USB device.
  - Change the source to any source other than USB. Remove the USB device.
- 

## Apple CarPlay

---

**The speed sensor must be connected to use Apple CarPlay wirelessly. Please verify the proper connections or plug in by USB to use Apple CarPlay.**

The speed pulse is not detected when the Apple CarPlay is started by connecting wirelessly or when the iPhone compatible with wireless Apple CarPlay is registered in **Apple CarPlay Device List**.

- Check the connection of the speed pulse or plug in over USB to use Apple CarPlay.
- 

**The GPS antenna must be connected to use Apple CarPlay wirelessly. Please verify the proper connections or plug in by USB to use Apple CarPlay.**

The GPS antenna is not connected when the Apple CarPlay is started by connecting wirelessly or when the iPhone compatible with wireless Apple CarPlay is registered in **Apple CarPlay Device List**.

- Check the connection of the GPS antenna or plug in over USB to use Apple CarPlay.
- 

**The speed sensor and the GPS antenna must be connected to use Apple CarPlay wirelessly. Please verify the proper connections or plug in by USB to use Apple CarPlay.**

The speed pulse is not detected and the GPS antenna is not connected when the Apple CarPlay is started by connecting wirelessly or when the iPhone compatible with wireless Apple CarPlay is registered in **Apple CarPlay Device List**.

- Check the connection of the speed pulse and the GPS antenna or plug in over USB to use Apple CarPlay.

# Appendix

## Playable Media and Files

You can play various kinds of media and files on this unit.

### List of playable discs (WS / 9019)

Disc types / Standard		Support	Remark
DVD	DVD Video	○	
	DVD Audio	×	
	DVD-VR	×	
	DVD-R*1	○	<ul style="list-style-type: none"> <li>• MP3 / WMA / AAC / WAV / FLAC / Vorbis / MPEG-1 / MPEG-2 / MPEG-4 / H.264 / WMV / MKV playback</li> <li>• Multi-border/Multisession playback (Playback depends on authoring conditions)</li> </ul>
	DVD-RW	○	
	DVD+R	○	
	DVD+RW	○	
	DVD-R DL (Dual layer)	○	Only video format
DVD+R DL (Double layer)	○		
DVD-RAM	×		
CD	Music CD*1	○	
	CD-ROM	○	<ul style="list-style-type: none"> <li>• MP3 / WMA / AAC / WAV / FLAC / Vorbis playback</li> </ul>
	CD-R	○	<ul style="list-style-type: none"> <li>• Multisession is supported.</li> </ul>
	CD-RW	○	<ul style="list-style-type: none"> <li>• Packet write is not supported.</li> </ul>
	DTS-CD	×	
	Video CD (VCD)	○	
	Super video CD	×	
	Photo CD	×	
	CD-EXTRA	△	Only music CD session can be played.
	HDCD	△	Normal music CD sound quality
	CCCD	×	
Others	Dualdisc	×	
	Super audio CD	△	Only CD layer can be played.

○ : Playback is possible.

△ : Playback is partly possible.

×

\*1 Incompatible with 8 cm (3 inch) discs.

### Use of DualDisc

When playing a "DualDisc" on this unit, the surface of the disc that is not played may be scratched while the disc is inserted or ejected. Since the music CD surface does not conform to the CD standard, playback may be impossible.

(A "DualDisc" is a disc with one surface containing DVD standard signals and the other surface containing music CD signals.)

### About disc format

The disc format should be the one of the following.

- ISO 9660 Level 1, 2
- Joliet
- Romeo
- Long file name

## About files

The following audio and video files are supported.

### ■ Playable Audio files

	Format	Bit rate	Sampling frequency	Bit count
AAC-LC (.m4a)	MPEG-2/MPEG-4 AAC LC HE-AAC(V1,V2)	8 – 320kbps, VBR	16 – 48 kHz	16 bit
MP3 (.mp3)	MPEG-1/MPEG-2 Audio Layer 3	8 – 320kbps, VBR	16 – 48 kHz	16 bit
WMA (.wma)	Windows Media Audio Standard L3 profile (Version 7,8,9)	8 – 320kbps	16 – 48 kHz	16 bit
Linear PCM (WAVE) (.wav)	RIFF waveform Audio Format	–	16 – 48 kHz (Disc), 16 – 192 kHz (USB)	16 bit/24 bit
FLAC (.flac)	flac	–	16 – 48 kHz (Disc), 16 – 192 kHz (USB)	16 bit/24 bit
Vorbis (.ogg)	vorbis	–	16 – 48 kHz	16 bit

- If music of normal CD and other playback systems are recorded in the same disc, only the playback system recorded at the first setout is played.
- WMA and AAC files with DRM cannot be played.
- Although the audio files complies with the standards listed above, they may not be played depending on the types or conditions of media or device.
- This unit supports playback of High-Resolution Audio files.  
It is recommended that a car audio system should be configured with all High-Resolution Audio compatible products from player to speaker to enjoy its high quality sound.

### ■ Acceptable Video files

	Profile	Max. Picture size	Max. bit rate	Audio format
MPEG-1 (.mpg, .mpeg)	–	352 × 240, 352 × 288	1.5 Mbps	MPEG Audio Layer 2
MPEG-2 (.mpg, .mpeg)	MP@ML	720 × 480, 720 × 576	8 Mbps	MPEG Audio Layer 2
H.264/MPEG-4 AVC (.mp4, .m4v, .avi, .flv, .f4v)	Baseline Profile, Main Profile	1920 × 1080 (30 fps)	8 Mbps	MP3, AAC
MPEG-4 (.mp4, .avi)	Advanced Simple Profile	1920 × 1080 (30 fps)	8 Mbps	MP3, AAC
WMV (.wmv)	Main Profile	1920 × 1080 (30 fps)	8 Mbps	WMA
MKV (.mkv)	Video format follows H.264/MPEG-4 AVC, MPEG-4, WMV			MP3, AAC, WMA, Vorbis, FLAC

- This unit can only play back files which are smaller than 4 GB.

### ■ Limitation on structure of file and folder

	Disc media	USB device
Maximum number of folder layers	8	8
Maximum number of files (per folder)	999	999
Maximum number of folders (per folder)	5000	9999
Maximum number of folders (per device)	5000	Unlimited

- You can enter a folder name and file name with 254 (for Disc)/255 (for USB) or fewer single-byte characters.
- Files in the folder whose folder name begins with a dot (.) cannot be played.



## Region Codes in the World

The DVD players are given a region code according to the country or area it is marketed, as shown in the following map.

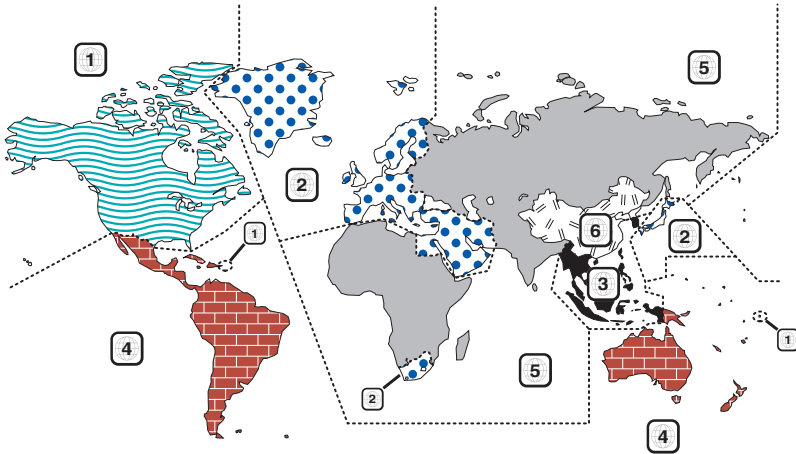

### ■ DVD disc marks



Indicates a region number. The discs with this mark can be played with any DVD player.



Indicates the number of audio languages recorded. Up to 8 languages can be recorded in a movie. You can select a favorite language.



Indicates the number of subtitled languages recorded. Up to 32 languages can be recorded.



If a DVD disc has scenes shot from multiple angles, you can select a favorite angle.



Indicates the type of screen for the image. The left mark indicates that a wide image picture (16:9) is displayed on a standard TV set screen (4:3) with a black band at both the top and bottom of the screen (letter box).

### ■ Operation regulatory marks

With this DVD, some functions of this unit such as the play function may be restricted depending on the location where the DVD is playing. In this case, the following marks will appear on the screen. For more information, refer to the disc manual.



### ■ Discs with limited period of use

Do not leave discs with a limited period of use in this unit. If you load an already expired disc, you may not be able to remove it from this unit.

## DVD Language Codes

Code	Language
aa	Afar
ab	Abkhazian
af	Afrikaans
am	Amharic
ar	Arabic
as	Assamese
ay	Aymara
az	Azerbaijani
ba	Bashkir
be	Byelorussian
bg	Bulgarian
bh	Bihari
bi	Bislama
bn	Bengali, Bangla
bo	Tibetan
br	Breton
ca	Catalan
co	Corsican
cs	Czech
cy	Welsh
da	Danish
de	German
dz	Bhutani
el	Greek
en	English
eo	Esperanto
es	Spanish
et	Estonian
eu	Basque
fa	Persian
fi	Finnish
fj	Fiji
fo	Faroese
fr	French
fy	Frisian
ga	Irish
gd	Scots Gaelic
gl	Galician
gn	Guarani
gu	Gujarati
ha	Hausa
he	Hebrew
hi	Hindi
hr	Croatian
hu	Hungarian
hy	Armenian

Code	Language
ia	Interlingua
ie	Interlingue
ik	Inupiak
id	Indonesian
is	Icelandic
it	Italian
ja	Japanese
jv	Javanese
ka	Georgian
kk	Kazakh
kl	Greenlandic
km	Cambodian
kn	Kannada
ko	Korean
ks	Kashmiri
ku	Kurdish
ky	Kirghiz
la	Latin
lb	Luxembourgish
ln	Lingala
lo	Laotian
lt	Lithuanian
lv	Latvian, Lettish
mg	Malagasy
mi	Maori
mk	Macedonian
ml	Malayalam
mn	Mongolian
mo	Moldavian
mr	Marathi
ms	Malay
mt	Maltese
my	Burmese
na	Nauru
ne	Nepali
nl	Dutch
no	Norwegian
oc	Occitan
om	(Afan) Oromo
or	Oriya
pa	Punjabi
pl	Polish
ps	Pashto, Pushto
pt	Portuguese
qu	Quechua
rm	Rhaeto-Romance

Code	Language
rn	Kirundi
ro	Romanian
ru	Russian
rw	Kinyarwanda
sa	Sanskrit
sd	Sindhi
sg	Sangho
sh	Serbo-Croatian
si	Singhalese
sk	Slovak
sl	Slovenian
sm	Samoan
sn	Shona
so	Somali
sq	Albanian
sr	Serbian
ss	Siswati
st	Sesotho
su	Sundanese
sv	Swedish
sw	Swahili
ta	Tamil
te	Telugu
tg	Tajik
th	Thai
ti	Tigrinya
tk	Turkmen
tl	Tagalog
tn	Setswana
to	Tongan
tr	Turkish
ts	Tsonga
tt	Tatar
tw	Twi
uk	Ukrainian
ur	Urdu
uz	Uzbek
vi	Vietnamese
vo	Volapuk
wo	Wolof
xh	Xhosa
yo	Yoruba
zh	Chinese
zu	Zulu

## Specifications

### ■ Monitor section

#### Picture Size

DDX919WS / DDX919WSM / DDX9019DABS /  
DDX9019S / DDX9019SM  
: 6.75 inches (diagonal) wide  
: 152.1 mm (W) × 79.5 mm (H)  
5-63/64 × 3-1/8 inch  
DMX8019DABS / DMX8019S  
: 6.95 inches (diagonal) wide  
: 156.6 mm (W) × 81.6 mm (H)  
6-3/16 × 3-3/16 inch

#### Display System

DDX919WS / DDX919WSM / DDX9019DABS /  
DDX9019S / DDX9019SM  
: AAS LCD panel  
DMX8019DABS / DMX8019S  
: TN LCD panel

#### Drive System

: TFT active matrix system

#### Number of Pixels

DDX919WS / DDX919WSM / DDX9019DABS /  
DDX9019S / DDX9019SM  
: 2,764,800 (1280H x 720V x RGB)  
DMX8019DABS / DMX8019S  
: 1,152,000 (800H x 480V x RGB)

#### Effective Pixels

: 99.99 %

#### Pixel Arrangement

: RGB striped arrangement

#### Back Lighting

: LED

### ■ DVD player section

(DDX919WS / DDX919WSM /  
DDX9019DABS / DDX9019S /  
DDX9019SM)

#### D/A Converter

: 24 bit/32 bit

#### Audio Decoder

: Linear PCM / Dolby Audio / MP3 / WMA / AAC /  
WAV / FLAC / Vorbis

#### Video Decoder

: MPEG-1 / MPEG-2 / MPEG-4 / WMV / H.264 / MKV

#### Wow & Flutter

: Below Measurable Limit

#### Frequency Response

- 96 kHz : 20 – 44,000 Hz
- 48 kHz : 20 – 22,000 Hz
- 44.1 kHz : 20 – 20,000 Hz

#### Total Harmonic Distortion

: 0.010 % (1 kHz)

#### S/N Ratio (dB)

: 90.5 dB (DVD-Video 96 kHz)

#### Dynamic Range

: 89 dB (DVD-Video 96 kHz)

#### Disc Format

: DVD-Video / VIDEO-CD / CD-DA

#### Quantifying Bit Number

: 16 bit/20 bit/24 bit

### ■ USB interface section

#### USB Standard

: USB 2.0 High Speed

#### File System

: FAT16, FAT32, exFAT, NTFS

#### Maximum Power Supply Current

: DC 5 V  $\pm$  1.5 A × 2

#### D/A Converter

: 24 bit/32 bit

#### Audio Decoder

: MP3 / WMA / AAC / WAV / FLAC / Vorbis

#### Video Decoder

: MPEG-1 / MPEG-2 / MPEG-4 / WMV / H.264 / MKV

#### Frequency Response (DMX8019DABS / DMX8019S)

- 192 kHz : 20 – 88,000 Hz
- 96 kHz : 20 – 44,000 Hz
- 48 kHz : 20 – 22,000 Hz
- 44.1 kHz : 20 – 20,000 Hz

#### Total Harmonic Distortion (DMX8019DABS / DMX8019S)

: 0.0001 % (1 kHz)

#### S/N Ratio (dB) (DMX8019DABS / DMX8019S)

: 98.5 dB

#### Dynamic Range (DMX8019DABS / DMX8019S)

: 89 dB

### ■ Wireless Mirroring Section (Except DMX8019S)

#### Mode

: Sink

#### Copyright protection

: HDCP2.2

#### Touch Control

: UIBC

### ■ Wi-Fi section

#### (Except DMX8019S)

#### IEEE Standard

DDX919WS / DDX9019DABS / DDX9019S /  
DMX8019DABS  
: 802.11 a/b/g/n/ac  
DDX919WSM / DDX9019SM  
: 802.11 b/g/n

#### Frequency Range

DDX919WS / DDX9019DABS / DDX9019S /  
DMX8019DABS  
: Dual Band (2.4GHz/5GHz)  
DDX919WSM / DDX9019SM  
: 2.4 GHz

## Appendix

### Channels

DDX919WS / DDX9019DABS / DDX9019S /  
DMX8019DABS  
: Auto (1-11ch)/Auto (149,153,157,161ch)  
DDX919WSM / DDX9019SM  
: Auto (1-11ch)

### Transfer rates (MAX)

DDX919WS / DDX9019DABS / DDX9019S /  
DMX8019DABS  
Outside Indonesia area : 11a: 54 Mbps /  
11b: 11 Mbps /  
11g: 54 Mbps /  
11n: 300 Mbps /  
11ac: 867 Mbps  
For Indonesia sales area : 11a: 54 Mbps /  
11b: 11 Mbps /  
11g: 54 Mbps /  
11n: 144 Mbps /  
11ac: 144 Mbps  
DDX919WSM / DDX9019SM  
: 11b: 11 Mbps / 11g: 54 Mbps / 11n: 72.2 Mbps

### Output Power (MAX)

**2.4 GHz/SISO**  
: 11b: 14 dBm ± 2 dB / 11g: 13 dBm ± 2 dB /  
11n (20 MHz): 12 dBm ± 2 dB

**5 GHz/SISO**  
(DDX919WS / DDX9019DABS / DDX9019S /  
DMX8019DABS)  
: 11a: 9 dBm ± 2 dB /  
11n (20 MHz)/11ac (20 MHz): 9 dBm ± 2 dB /  
11n (40 MHz)/11ac (40 MHz): 8 dBm ± 2 dB /  
11ac (80 MHz): 8 dBm ± 2 dB

**5 GHz/MIMO**  
(DDX919WS / DDX9019DABS / DDX9019S /  
DMX8019DABS)  
: 11n (20 MHz)/11ac (20 MHz): 11 dBm ± 2 dB /  
11n (40 MHz)/11ac (40 MHz): 11 dBm ± 2 dB /  
11ac (80 MHz): 11 dBm ± 2 dB

## Bluetooth section

### Technology

: Bluetooth Ver.5.0

### Frequency

: 2.402 – 2.480 GHz

### Output Power

: +4dBm (MAX), Power Class2

### Maximum Communication range

: Line of sight approx. 10m (32.8 ft)

### Audio Codec

: SBC/AAC

### Profile (Multi Profile support)

- HFP (V1.7) (Hands Free Profile)
- SPP (Serial Port Profile)
- A2DP (Advanced Audio Distribution Profile)
- AVRCP (V1.6) (Audio/Video Remote Control Profile)
- PBAP (Phonebook Access Profile)

## DSP section

### Graphics equalizer

Band: 13 Band  
Frequency (BAND1 – 13)  
: 62.5/100/160/250/400/630/1k/1.6k/2.5k/4k/6.3k/  
10k/16k Hz

### Gain

: -9/-8/-7/-6/-5/-4/-3/-2/-1/0/1/2/3/4/5/6/7/8/9 dB

### 2-way X'Over

#### High pass filter

Frequency: Through, 30/40/50/60/70/80/90/100/  
120/150/180/220/250 Hz  
Slope: -6/-12/-18/-24 dB/Oct.

#### Low pass filter

Frequency: 30/40/50/60/70/80/90/100/120/150/  
180/220/250 Hz, Through  
Slope: -6/-12/-18/-24 dB/Oct.

### 3-way X'Over

Except DMX8019S

#### High pass filter

Frequency: 250/300/1k/1.6k/2.5k/4k/5k/6.3k/8k/  
10k/12.5k Hz  
Slope: -12/-18/-24 dB/Oct.

#### Band pass filter

Frequency: Through, 50/60/70/80/90/100/120/150/  
180/220/250/300 Hz  
250/300/1k/1.6k/2.5k/4k/5k/6.3k/8k Hz,  
Through

Slope: -12/-18/-24 dB/Oct.

#### Low pass filter

Frequency: 30/40/50/60/70/80/90/100/120/150 Hz,  
Through  
Slope: -12/-18/-24 dB/Oct.

### Position

#### Front / Rear /Subwoofer Delay

: 0 – 6.1 m (0.01 m Step)

#### Gain

: -8 – 0 dB

### Subwoofer level

: -50 – +10 dB

## HDMI section (Except DMX8019S)

### HDMI

: Type-A

### Input Resolution

- VGA (640x480p @59.94Hz/60Hz)
- 480p (720x480p @59.94Hz/60Hz)
- 720p (1280x720p @59.94Hz/60Hz)

### Input Audio Type

: 32K/44.1K/48K/88.2K/96K/176.2K/192K Hz  
16 bit/20 bit/24 bit Linear PCM

## Digital Radio section

### (DDX9019DABS / DMX8019DABS)

### Frequency Range

BAND III: 174.928 – 239.200 (MHz)

**Sensitivity**  
: -100 dBm

**S/N Ratio (dB)**  
: 90 dB

## ■ Digital Antenna Connector section (DDX9019DABS / DMX8019DABS)

**Connector type**  
: SMB

**Output Voltage (11 – 16V)**  
: 14.4 V

**Maximum Current**  
: < 100 mA

## ■ FM tuner section

**Frequency Range (step)**  
: 87.5 MHz – 108.0 MHz (50 kHz)

**Usable Sensitivity (S/N : 30 dB)**  
: 9.3 dBf (0.8  $\mu$ V/75  $\Omega$ )

**Quieting Sensitivity (S/N : 46 dB)**  
: 15.2 dBf (1.6  $\mu$ V/ 75  $\Omega$ )

**Frequency Response**  
: 30 Hz – 15 kHz

**S/N Ratio (dB)**  
: 65 dB (MONO)

**Selectivity ( $\pm$  400 kHz)**  
: Over 80 dB

**Stereo Separation**  
: 45 dB (1 kHz)

## ■ AM tuner section

**Frequency Range (step)**  
DDX919WS / DDX9019S / DMX8019S  
(for asia sales area)  
: 531 kHz – 1611 kHz (9 kHz)  
DDX919WS / DDX9019DABS / DMX8019DABS  
(for oceania sales area)  
: 531 kHz – 1701 kHz (9 kHz)  
DDX919WSM / DDX9019SM  
: 531 kHz – 1602 kHz (9 kHz)

**Usable Sensitivity**  
DDX919WS / DDX9019S / DMX8019S  
(for asia sales area)  
: 25 $\mu$ V  
DDX919WS / DDX9019DABS / DMX8019DABS  
(for oceania sales area)  
: 28dB $\mu$   
DDX919WSM / DDX9019SM  
: 25 $\mu$ V

## ■ Video section

**Color System of External Video Input**  
: NTSC/PAL

**External Video Input Level (mini jack)**  
: 1 Vp-p/75  $\Omega$

**External Audio Max Input Level (mini jack)**  
: 2 V/25 k $\Omega$

**Video Input Level (RCA jacks)**  
: 1 Vp-p/75  $\Omega$

**Video Output Level (RCA jacks)**  
: 1 Vp-p/75  $\Omega$

**Audio Output Level (mini jack)**  
: 0.9 V/10 k $\Omega$

## ■ Audio section

**Maximum Power (Front & Rear)**  
: 50 W  $\times$  4

**Typical Power Output (Front & Rear)**  
Full Bandwidth Power (at less than 1% THD)  
: 22 W  $\times$  4

**Output frequency band**  
: 20 – 88,000 Hz

**Preout Level (V)**  
Except DMX8019S  
: 5 V/10 k $\Omega$   
DMX8019S  
: 4 V/10 k $\Omega$

**Preout Impedance**  
:  $\leq$  300  $\Omega$

**Speaker Impedance**  
: 4 – 8  $\Omega$

## ■ General

**Operating Voltage**  
: 12 V DC car battery

**Installation Dimensions (W  $\times$  H  $\times$  D)**  
DDX919WS / DDX919WSM / DDX9019DABS /  
DDX9019S / DDX9019SM  
: 178  $\times$  100  $\times$  160 mm  
DMX8019DABS / DMX8019S  
: 178  $\times$  100  $\times$  155 mm

**Weight**  
DDX919WS / DDX919WSM / DDX9019DABS /  
DDX9019S / DDX9019SM  
: 2.4 kg  
DMX8019DABS / DMX8019S  
: 1.7 kg

### NOTE

- Although the effective pixels for the liquid crystal panel is given as 99.99% or more, 0.01% of pixels may not light or may light incorrectly.

**Specifications are subject to change without prior notice.**

## About this Unit

### ■ Copyrights

- The Bluetooth® word mark and logos are registered trademarks owned by the Bluetooth SIG, Inc. and any use of such marks by JVC KENWOOD Corporation is under license. Other trademarks and trade names are those of their respective owners.
- Manufactured under license from Dolby Laboratories. Dolby, Dolby Audio and the double-D symbol are trademarks of Dolby Laboratories.



-  is a trademark of DVD Format/Logo Licensing Corporation registered in the U.S., Japan and other countries.
- This item incorporates copy protection technology that is protected by U.S. patents and other intellectual property rights of Rovi Corporation. Reverse engineering and disassembly are prohibited.
- Microsoft and Windows Media are either registered trademarks or trademarks of Microsoft Corporation in the United States and/or other countries.
- This software is based in part on the work of the independent JPEG Group.
- The "AAC" logo is a trademark of Dolby Laboratories.
- Use of the Made for Apple badge means that an accessory has been designed to connect specifically to the Apple product(s) identified in the badge, and has been certified by the developer to meet Apple performance standards. Apple is not responsible for the operation of this device or its compliance with safety and regulatory standards. Please note that the use of this accessory with an Apple product may affect wireless performance.
- Apple, iPhone, iPod, iPod touch, and Lightning are trademarks of Apple Inc., registered in the U.S. and other countries.
- Apple, Siri, Apple CarPlay and Apple CarPlay logo are trademarks of Apple Inc., registered in the U.S. and other countries.
- SPOTIFY and the Spotify logo are among the registered trademarks of Spotify AB.
- Android, Android Auto, Google Play and other marks are trademarks of Google LLC.
- Wi-Fi® is a registered trademark of Wi-Fi Alliance®.
- The Wi-Fi CERTIFIED™ Logo is a certification mark of Wi-Fi Alliance®.
- This product includes FontAvenue® fonts licenced by NEC Corporation. FontAvenue is a registered trademark of NEC Corporation.



**FontAvenue**

- This product includes "Ubiquitous QuickBoot™" technology developed by Ubiquitous Corp. Ubiquitous QuickBoot™ is a trademark of Ubiquitous Corp. Copyright© 2017 Ubiquitous Corp. All rights reserved.



Ubiquitous

- THIS PRODUCT IS LICENSED UNDER THE AVC PATENT PORTFOLIO LICENSE FOR THE PERSONAL USE OF A CONSUMER OR OTHER USES IN WHICH IT DOES NOT RECEIVE REMUNERATION TO (i) ENCODE VIDEO IN COMPLIANCE WITH THE AVC STANDARD ("AVC VIDEO") AND/OR (ii) DECODE AVC VIDEO THAT WAS ENCODED BY A CONSUMER ENGAGED IN A PERSONAL ACTIVITY AND/OR WAS OBTAINED FROM A VIDEO PROVIDER LICENSED TO PROVIDE AVC VIDEO. NO LICENSE IS GRANTED OR SHALL BE IMPLIED FOR ANY OTHER USE. ADDITIONAL INFORMATION MAY BE OBTAINED FROM MPEG LA, L.L.C. SEE [HTTP://WWW.MPEGLA.COM](http://www.mpegla.com)
- THIS PRODUCT IS LICENSED UNDER THE MPEG-4 VISUAL PATENT PORTFOLIO LICENSE FOR THE PERSONAL AND NON-COMMERCIAL USE OF A CONSUMER FOR (i) ENCODING VIDEO IN COMPLIANCE WITH THE MPEG-4 VISUAL STANDARD ("MPEG-4 VIDEO") AND/OR (ii) DECODING MPEG-4 VIDEO THAT WAS ENCODED BY A CONSUMER ENGAGED IN A PERSONAL AND NON-COMMERCIAL ACTIVITY AND/OR WAS OBTAINED FROM A VIDEO PROVIDER LICENSED BY MPEG LA TO PROVIDE MPEG-4 VIDEO. NO LICENSE IS GRANTED OR SHALL BE IMPLIED FOR ANY OTHER USE. ADDITIONAL INFORMATION INCLUDING THAT RELATING TO PROMOTIONAL, INTERNAL AND COMMERCIAL USES AND LICENSING MAY BE OBTAINED FROM MPEG LA, LLC. SEE [HTTP://WWW.MPEGLA.COM](http://www.mpegla.com).
- THIS PRODUCT IS LICENSED UNDER THE VC-1 PATENT PORTFOLIO LICENSE FOR THE PERSONAL AND NON-COMMERCIAL USE OF A CONSUMER TO (i) ENCODE VIDEO IN COMPLIANCE WITH THE VC-1 STANDARD ("VC-1 VIDEO") AND/OR (ii) DECODE VC-1 VIDEO THAT WAS ENCODED BY A CONSUMER ENGAGED IN A PERSONAL AND NON-COMMERCIAL ACTIVITY AND/OR WAS OBTAINED FROM A VIDEO PROVIDER LICENSED TO PROVIDE VC-1 VIDEO. NO LICENSE IS GRANTED OR SHALL BE IMPLIED FOR ANY OTHER USE. ADDITIONAL INFORMATION MAY BE OBTAINED FROM MPEG LA, L.L.C. SEE [HTTP://WWW.MPEGLA.COM](http://www.mpegla.com)
- libFLAC  
Copyright (C) 2000-2009 Josh Coalson  
Copyright (C) 2011-2013 Xiph.Org Foundation  
Redistribution and use in source and binary forms, with or without modification, are permitted provided that the following conditions are met:
  - Redistributions of source code must retain the above copyright notice, this list of conditions and the following disclaimer.
  - Redistributions in binary form must reproduce the above copyright notice, this list of conditions and the following disclaimer in the documentation and/or other materials provided with the distribution.
  - Neither the name of the Xiph.org Foundation nor the names of its contributors may be used to endorse or promote products derived from this software without specific prior written permission.

THIS SOFTWARE IS PROVIDED BY THE COPYRIGHT HOLDERS AND CONTRIBUTORS "AS IS" AND ANY EXPRESS OR IMPLIED WARRANTIES, INCLUDING, BUT NOT LIMITED TO, THE IMPLIED WARRANTIES OF MERCHANTABILITY AND FITNESS FOR A PARTICULAR PURPOSE ARE DISCLAIMED. IN NO EVENT SHALL THE FOUNDATION OR CONTRIBUTORS BE LIABLE FOR ANY DIRECT, INDIRECT, INCIDENTAL, SPECIAL, EXEMPLARY, OR CONSEQUENTIAL DAMAGES (INCLUDING, BUT NOT LIMITED TO, PROCUREMENT OF SUBSTITUTE GOODS OR SERVICES; LOSS OF USE, DATA, OR PROFITS; OR BUSINESS INTERRUPTION) HOWEVER CAUSED AND ON ANY THEORY OF LIABILITY, WHETHER IN CONTRACT, STRICT LIABILITY, OR TORT (INCLUDING NEGLIGENCE OR OTHERWISE) ARISING IN ANY WAY OUT OF THE USE OF THIS SOFTWARE, EVEN IF ADVISED OF THE POSSIBILITY OF SUCH DAMAGE.

- libvorbis

Copyright (c) 2002-2008 Xiph.org Foundation  
Redistribution and use in source and binary forms, with or without modification, are permitted provided that the following conditions are met:

- Redistributions of source code must retain the above copyright notice, this list of conditions and the following disclaimer.
- Redistributions in binary form must reproduce the above copyright notice, this list of conditions and the following disclaimer in the documentation and/or other materials provided with the distribution.
- Neither the name of the Xiph.org Foundation nor the names of its contributors may be used to endorse or promote products derived from this software without specific prior written permission.

THIS SOFTWARE IS PROVIDED BY THE COPYRIGHT HOLDERS AND CONTRIBUTORS "AS IS" AND ANY EXPRESS OR IMPLIED WARRANTIES, INCLUDING, BUT NOT LIMITED TO, THE IMPLIED WARRANTIES OF MERCHANTABILITY AND FITNESS FOR A PARTICULAR PURPOSE ARE DISCLAIMED. IN NO EVENT SHALL THE FOUNDATION OR CONTRIBUTORS BE LIABLE FOR ANY DIRECT, INDIRECT, INCIDENTAL, SPECIAL, EXEMPLARY, OR CONSEQUENTIAL DAMAGES (INCLUDING, BUT NOT LIMITED TO, PROCUREMENT OF SUBSTITUTE GOODS OR SERVICES; LOSS OF USE, DATA, OR PROFITS; OR BUSINESS INTERRUPTION) HOWEVER CAUSED AND ON ANY THEORY OF LIABILITY, WHETHER IN CONTRACT, STRICT LIABILITY, OR TORT (INCLUDING NEGLIGENCE OR OTHERWISE) ARISING IN ANY WAY OUT OF THE USE OF THIS SOFTWARE, EVEN IF ADVISED OF THE POSSIBILITY OF SUCH DAMAGE.

- libogg

Copyright (c) 2002, Xiph.org Foundation  
Redistribution and use in source and binary forms, with or without modification, are permitted provided that the following conditions are met:

- Redistributions of source code must retain the above copyright notice, this list of conditions and

the following disclaimer.

- Redistributions in binary form must reproduce the above copyright notice, this list of conditions and the following disclaimer in the documentation and/or other materials provided with the distribution.
  - Neither the name of the Xiph.org Foundation nor the names of its contributors may be used to endorse or promote products derived from this software without specific prior written permission.
- THIS SOFTWARE IS PROVIDED BY THE COPYRIGHT HOLDERS AND CONTRIBUTORS "AS IS" AND ANY EXPRESS OR IMPLIED WARRANTIES, INCLUDING, BUT NOT LIMITED TO, THE IMPLIED WARRANTIES OF MERCHANTABILITY AND FITNESS FOR A PARTICULAR PURPOSE ARE DISCLAIMED. IN NO EVENT SHALL THE FOUNDATION OR CONTRIBUTORS BE LIABLE FOR ANY DIRECT, INDIRECT, INCIDENTAL, SPECIAL, EXEMPLARY, OR CONSEQUENTIAL DAMAGES (INCLUDING, BUT NOT LIMITED TO, PROCUREMENT OF SUBSTITUTE GOODS OR SERVICES; LOSS OF USE, DATA, OR PROFITS; OR BUSINESS INTERRUPTION) HOWEVER CAUSED AND ON ANY THEORY OF LIABILITY, WHETHER IN CONTRACT, STRICT LIABILITY, OR TORT (INCLUDING NEGLIGENCE OR OTHERWISE) ARISING IN ANY WAY OUT OF THE USE OF THIS SOFTWARE, EVEN IF ADVISED OF THE POSSIBILITY OF SUCH DAMAGE.

- The marking of products using lasers  
(DDX919WS / DDX919WSM /  
DDX9019DABS / DDX9019S /  
DDX9019SM)

**CLASS 1  
LASER PRODUCT**

The label is attached to the chassis/case and says that the component uses laser beams that have been classified as Class 1. It means that the unit is utilizing laser beams that are of a weaker class. There is no danger of hazardous radiation outside the unit.

- For DDX919WSM / DDX9019SM



**Declaration of Conformity with regard to the RE Directive 2014/53/EU**

**Declaration of Conformity with regard to the RoHS Directive 2011/65/EU**

**Manufacturer:**

JVC KENWOOD Corporation  
3-12, Moriyacho, Kanagawa-ku, Yokohama-shi,  
Kanagawa 221-0022, JAPAN

**EU Representative:**

JVKENWOOD Europe B.V.  
Amsterdamseweg 37, 1422 AC UITHOORN, THE  
NETHERLANDS

**English**

Hereby, JVC KENWOOD declares that the radio equipment DDX919WSM / DDX9019SM is in compliance with Directive 2014/53/EU. The full text of the EU declaration of conformity is available at the following internet address:

**Türkçe**

Burada, JVC KENWOOD DDX919WSM / DDX9019SM radyo ekipmanının 2014/53/AB Direktifine uygun olduğunu bildirir. AB uyumluluk deklarasyonunun tam metni aşağıdaki internet adresinde mevcuttur.

**URL:** <http://www.kenwood.com/cs/ce/eudoc/>

- For Turkey

Bu ürün 28300 sayılı Resmî Gazete'de yayımlanan Atık Elektrikli ve Elektronik Eşyaların Kontrolü Yönetmeliğe uygun olarak üretilmiştir.

- Eski Elektrik ve Elektronik Ekipmanların İmha Edilmesi Hakkında Bilgi (ayrı atık toplama sistemlerini kullanan ülkeleri için uygulanabilir)



Sembollü (üzerinde çarpı işareti olan çöp kutusu) ürünler ev atıkları olarak atılamaz.

Eski elektrik ve elektronik ekipmanlar, bu ürünleri ve ürün atıklarını geri dönüştürebilecek bir tesiste değerlendirilmelidir. Yaşadığınız bölgeye en yakın geri dönüşüm tesisinin yerini öğrenmek için yerel makamlara müracaat edin. Uygun geri dönüşüm ve atık imha yöntemi sağlığımız ve çevremiz üzerindeki zararlı etkileri önlerken kaynakların korunmasına da yardımcı olacaktır.

- מידע בדבר השלכה לאשפה של ציוד חשמלי ואלקטרוני ישן וכן סוללות (רלוונטי למדינות

שמשמשות במתחנת איסוף אשפה מורדת).

לא ניתן להשליך מוצרים וסוללות עם הסימון (פח אשפה עם X עליו) כאשפה ביתית רגילה.

יש למחזר ציוד חשמלי ואלקטרוני ישן וכן סוללות במתקן המסוגל לטפל בפריטים כאלה ובתוצרי הלואי שלהם.

צרו קשר עם הרשות המקומית לקבלת פריטים אודות מתקן המיחזור הקרוב אליכם. מיחזור והשלכה לאשפה נאותים יעזרו לשמר משאבים ולמנוע השפעות שליליות על בריאותנו ועל הסביבה.

שימו לב: הסימון Pb שמתחת לסימון עבור סוללות מציינ שהסוללה מכילה עופרת.



**Pb**

# KENWOOD