

INSTRUCTION MANUAL

JVC KENWOOD Corporation

MONITOR WITH DVD RECEIVER

DDX795 (Region 1 – DVD Region Code 1 Area)

DDX775BH (Region 1 – DVD Region Code 1 Area)

DDX6018BT (Region 4 – DVD Region Code 4 Area)

DDX5018BT (Region 4 – DVD Region Code 4 Area)

DDX595 (Region 1 – DVD Region Code 1 Area)

DDX575BT (Region 1 – DVD Region Code 1 Area)

DDX718WBTL (Region 4 – DVD Region Code 4 Area)

MONITOR WITH RECEIVER

DMX6018BT

DMX718WBTL

This instruction manual is used to describe the models listed above. Model availability and features (functions) may differ depending on the country and sales area.

Take the time to read through this instruction manual.

Familiarity with installation and operation procedures will help you obtain the best performance from your new receiver.

For your records

Record the serial number, found on the back of the unit, in the spaces designated on the warranty card, and in the space provided below. Refer to the model and serial numbers whenever you call upon your Kenwood dealer for information or service on the product.

Model DDX795/DDX775BH/DDX6018BT/DMX6018BT/DDX5018BT/DDX595/DDX575BT/DDX718WBTL/DMX718WBTL Serial number _____

US Residents Only

Register Online

Register your Kenwood product at www.kenwood.com/usa/

Important Notice

To ensure proper use, please read through this manual before using this product. It is especially important that you read and observe WARNINGS and CAUTIONS in this manual.

Please keep the manual in a safe and accessible place for future reference.

⚠ WARNINGS

To prevent accidents and damages

- DO NOT install any unit or wire any cable in a location where;
 - it may obstruct the steering wheel and gearshift lever operations.
 - it may obstruct the operation of safety devices such as air bags.
 - it may obstruct visibility.
- DO NOT raise the volume level too much, as this will make driving dangerous by blocking outside sounds, and may cause hearing loss.
- DO NOT operate the unit while driving. If you need to operate the unit while driving, be sure to look around carefully.
- Stop the car before performing any complicated operations.
- The driver must not watch the monitor while driving.

⚠ CAUTIONS

To care for the unit

- If you have parked the car for a long time in hot or cold weather, wait until the temperature in the car becomes normal before operating the unit.

To care for the monitor

- The monitor built into this unit has been produced with high precision, but it may have some ineffective dots. This is inevitable and is not considered defective.
- Do not expose the monitor to direct sunlight.
- Do not operate the touch panel using a ball-point pen or similar tool with a sharp tip. Touch the keys on the touch panel with your finger directly (if you are wearing a glove, take it off).
- When the temperature is very cold or very hot...
 - Chemical changes occur inside, causing malfunction.
 - Pictures may not appear clearly or may move slowly. Pictures may not be synchronized with the sound or picture quality may decline in such environments.

On the volume setting

- Digital devices produce very little noise compared with other sources. Lower the volume before playing these digital sources to avoid damaging the speakers by sudden increase of the output level.

For DDX6018BT/DDX5018BT/DDX718WBTL:



The marking of products using lasers

The label is attached to the chassis/case and says that the component uses laser beams that have been classified as Class 1. It means that the unit is utilizing laser beams that are of a weaker class. There is no danger of hazardous radiation outside the unit.

For DDX795/DDX775BH/DDX595/DDX575BT:

⚠ CAUTION

Use of controls or adjustments or performance of procedures other than those specified herein may result in hazardous radiation exposure. In compliance with Federal Regulations, the following are reproductions of labels on, or inside the product relating to laser product safety.

JVC KENWOOD Corporation
2967-3, ISHIKAWA-MACHI, HACHIOJI-SHI, TOKYO, JAPAN

THIS PRODUCT COMPLIES WITH DHHS RULES 21CFR
SUBCHAPTER J IN EFFECT AT DATE OF MANUFACTURE.

Location : Top plate

Important Notice

For DDX795/DDX775BH/DDX595/DDX575BT:

⚠ CAUTION

This equipment complies with FCC/IC radiation exposure limits set forth for an uncontrolled environment and meets the FCC radio frequency (RF) Exposure Guidelines and RSS-102 of the IC radio frequency (RF) Exposure rules. This equipment has very low levels of RF energy that is deemed to comply without maximum permissive exposure evaluation (MPE). But it is desirable that it should be installed and operated keeping the radiator at least 20 cm or more away from person's body.

- Contains Transmitter Module
FCC ID: 2ALS3-3901
- Contains Transmitter Module
IC: 22661-3901

For DDX795/DDX775BH/DDX595/DDX575BT:

FCC WARNING

This equipment may generate or use radio frequency energy. Changes or modifications to this equipment may cause harmful interference unless the modifications are expressly approved in the instruction manual. The user could lose the authority to operate this equipment if an unauthorized change or modification is made.

FCC NOTE

This equipment has been tested and found to comply with the limits for a Class B digital device, pursuant to Part 15 of the FCC Rules. These limits are designed to provide reasonable protection against harmful interference in a residential installation.

This equipment may cause harmful interference to radio communications, if it is not installed and used in accordance with the instructions. However, there is no guarantee that interference will not occur in a particular installation. If this equipment does cause harmful interference to radio or television reception, which can be determined by turning the equipment off and on, the user is encouraged to try to correct the interference by one or more of the following measures:

- Reorient or relocate the receiving antenna.
- Increase the separation between the equipment and receiver.
- Connect the equipment into an outlet on a circuit different from that to which the receiver is connected.
- Consult the dealer or an experienced radio/TV technician for help.

This transmitter must not be co-located or operated in conjunction with any other antenna or transmitter.

For DDX795/DDX775BH/DDX595/DDX575BT:

IC (Industry Canada) Notice

This device complies with Industry Canada's licence-exempt RSSs. Operation is subject to the following two conditions:

- (1) This device may not cause interference; and
 - (2) This device must accept any interference, including interference that may cause undesired operation of the device.
-

About this manual

The displays and panels shown in this manual are examples used to provide clear explanations of the operations. For this reason, they may be different from the actual displays or panels.

Illustrations of **DDX795** are mainly used for explanation.

This manual mainly explains operations using the buttons on the monitor panel and keys on the touch panel. For operations using the remote controller, see page 56.

< > indicates the various screens/menus/operations/settings that appear on the touch panel.

[] indicates the keys on the touch panel.

Indication language: English indications are used for the purpose of explanation. You can select the indication language from the <SETUP> menu. (Page 53)

Contents

Component Names and Operations	3	Using the external navigation unit.....	38
Basic Operations	5	Using an external component via ADS adapter—	
Turning on the power.....	5	OEM Features.....	39
Turning off the power/turning off the AV source.....	5	Bluetooth®	40
Putting the unit in standby.....	5	Information	40
Turning off the screen.....	5	Preparation	40
Adjusting the volume.....	6	Connection.....	40
Attenuating the sound.....	6	Bluetooth mobile phone.....	42
Monitor panel operations.....	6	Bluetooth audio player.....	45
Getting Started	7	Bluetooth mobile phone settings.....	46
Initial settings.....	7	Settings	46
Setting the security function.....	7	Audio settings.....	46
Calendar/clock settings.....	8	AV settings.....	50
Various Screens and Operations	8	Display settings.....	51
Touch screen operations.....	8	User interface settings.....	52
Home screen.....	9	Camera settings.....	53
Source control screen.....	10	Special system settings.....	54
List/setting screen.....	12	Bluetooth settings.....	55
Disc.....	13	Security settings.....	55
Video.....	14	Navigation settings.....	55
USB.....	16	Remote Controller.....	56
iPod/iPhone.....	17	Preparation.....	56
Apps—WebLink™.....	18	Basic operations for RC-DV340 (supplied).....	56
HD Radio™ tuner.....	19	Basic operations for KNA-RCDV331 (optionally purchased).....	58
Radio.....	22	KENWOOD Remote APP.....	60
SiriusXM® Satellite Radio.....	24	Installation and Connection.....	60
Pandora®.....	33	References.....	66
Spotify.....	35	Maintenance.....	66
Other External Components.....	36	More information.....	66
View camera.....	36	Troubleshooting.....	70
AV-IN.....	37	Specifications.....	73
Watching TV.....	38	Trademarks and licenses.....	77

Component Names and Operations

DDX795/DDX775BH/DDX6018BT

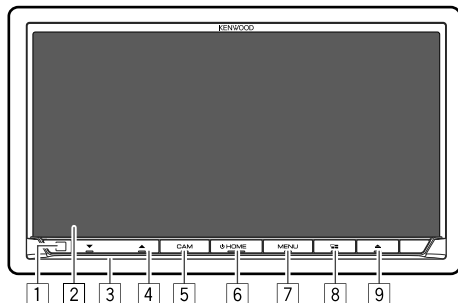

DMX6018BT

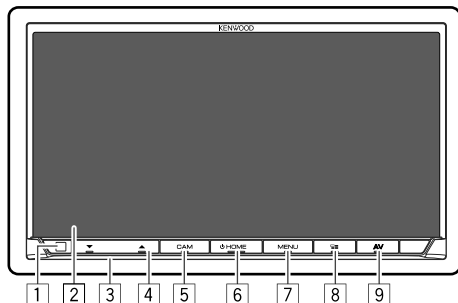

- 1 Remote sensor*1
- 2 Screen (touch panel)
- 3 Monitor panel
- 4 **VOLUME ▼/▲** button
- 5 **CAM/DISP OFF** button
 - **CAM** (Press): Displays the picture from the connected rear view camera.
 - **DISP OFF** (Hold): Turns off the screen.

- 6 **HOME** button
 - **HOME** (Press): Turns on the power.
 - **HOME** (Hold): Turns off the power or AV source.*2
 - **HOME** (Press): Displays the Home screen while the power is on.
- 7 **MENU/ATT** button
 - **MENU** (Press): Pops up the short-cut menu.
 - **ATT** (Hold): Attenuates the sound.
- 8 **App/VOICE** button
 - **App** (Press): Displays the App screen. (Page 19)
 - **VOICE** (Hold): Activates the voice dialing.
- 9 DDX795/DDX775BH/DDX6018BT: **▲** button
Displays the **<Angle Adjust>** screen. (Page 6)

DMX6018BT: **AV** button
Switches the screen between the navigation and the current source.

DDX5018BT

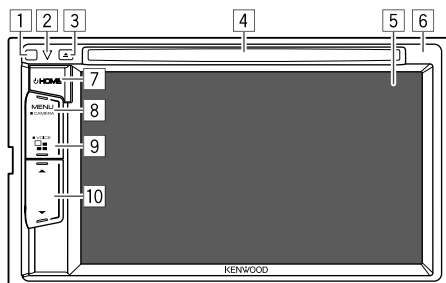

- 1 Remote sensor*1
- 2 Power indicator/Security indicator
 - Lights up while the unit is turned on.
 - Flashes when the security function is activated.
- 3 **▲** button
- 4 Loading slot
- 5 Screen (touch panel)
- 6 Monitor panel
- 7 **HOME** button
 - **HOME** (Press): Turns on the power.
 - **HOME** (Hold): Turns off the power or AV source.*2
 - **HOME** (Press): Displays the Home screen while the power is on.
- 8 **MENU/CAMERA** button
 - **MENU** (Press): Pops up the short-cut menu.
 - **CAMERA** (Hold): Displays the picture from the connected rear view camera.
- 9 **App/VOICE** button
 - **App** (Press): Displays the App screen. (Page 19)
 - **VOICE** (Hold): Activates voice dialing.
- 10 Volume **▲/▼** buttons

*1 **DO NOT** expose the remote sensor to bright light (direct sunlight or artificial lighting).

*2 The function of the button when held varies depending on the **<Manual Power OFF>** setting on the **<Special>** screen. (Page 54)

Component Names and Operations

DDX595/DDX575BT

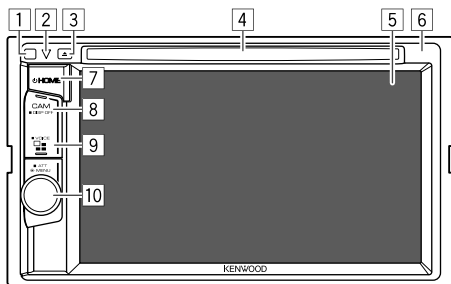

- 1 Remote sensor*1
- 2 Power indicator/Security indicator
 - Lights up while the unit is turned on.
 - Flashes when the security function is activated.
- 3 ▲ button
- 4 Loading slot
- 5 Screen (touch panel)
- 6 Monitor panel
- 7 ⏪ HOME button
 - ⏪ (Press): Turns on the power.
 - ⏪ (Hold): Turns off the power or AV source.*2
 - HOME (Press): Displays the Home screen while the power is on.
- 8 CAM/DISP OFF button
 - CAM (Press): Displays the picture from the connected rear view camera.
 - DISP OFF (Hold): Turns off the screen.
- 9 📱/VOICE button
 - 📱 (Press): Displays the App screen. (Page 19)
 - VOICE (Hold): Activates voice dialing.

10 Volume/MENU/ATT knob

- **Volume** (Turn): Adjusts the audio volume.
- **MENU** (Press): Pops up the short-cut menu.
- **ATT** (Hold): Attenuates the sound.

DDX718WBTL

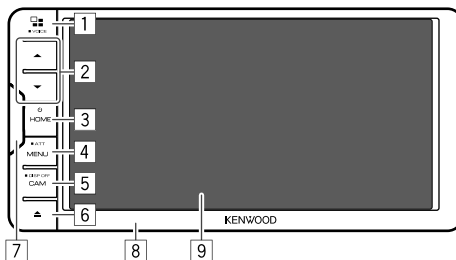

DMX718WBTL



- 1 📱/VOICE button
 - 📱 (Press): Displays the App screen. (Page 19)
 - VOICE (Hold): Activates voice dialing.
- 2 Volume ▲/▼ buttons

- 3 ⏪ HOME button
 - ⏪ (Press): Turns on the power.
 - ⏪ (Hold): Turns off the power or AV source.*2
 - HOME (Press): Displays the Home screen while the power is on.

- 4 MENU/ATT button
 - MENU (Press): Pops up the short-cut menu.
 - ATT (Hold): Attenuates the sound.
- 5 CAM/DISP OFF button
 - CAM (Press): Displays the picture from the connected rear view camera.
 - DISP OFF (Hold): Turns off the screen.

- 6 DDX718WBTL: ▲ button
Displays the <Angle Adjust> screen. (Page 6)

DMX718WBTL: AV button

Switches the screen between the navigation and the current source.

- 7 Remote sensor*1
- 8 Monitor panel
- 9 Screen (touch panel)

*1 DO NOT expose the remote sensor to bright light (direct sunlight or artificial lighting).

*2 The function of the button when held varies depending on the <Manual Power Off> setting on the <Special> screen. (Page 54)

Basic Operations

Turning on the power

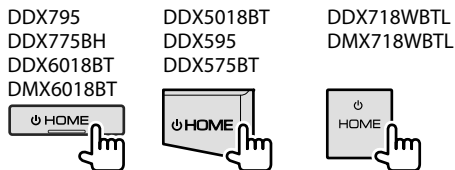

Turning off the power/turning off the AV source

- This function varies depending on the <Manual Power OFF> setting. (Page 54)

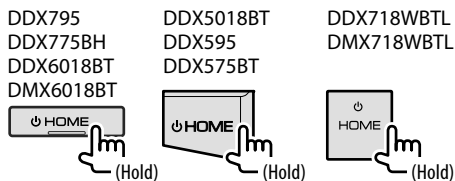

Putting the unit in standby

1 Display the source/option selection screen.

On the Home screen, touch as follows:



2 Put the unit in standby.

On the source/option selection screen, touch as follows:



Turning off the screen

On the pop-up short-cut menu

1 Display the pop-up short-cut menu.

DDX795
DDX775BH
DDX6018BT
DMX6018BT

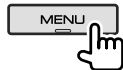

DDX595
DDX575BT



DDX5018BT



DDX718WBTL
DMX718WBTL

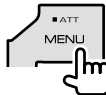

2 On the pop-up short-cut menu, touch as follows:

[Display OFF]

To turn on the screen: Touch the screen.

On the monitor panel

(Only for DDX795/DDX775BH/DDX6018BT/DMX6018BT/DDX595/DDX575BT/DDX718WBTL/DMX718WBTL)

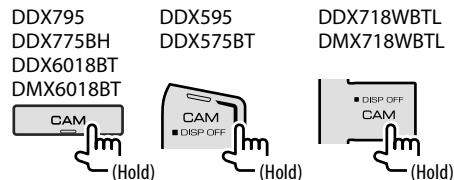

To turn on the screen: Press **DISP OFF** on the monitor panel or touch the screen.

Basic Operations

Adjusting the volume

DDX795
DDX775BH
DDX6018BT
DMX6018BT



DDX5018BT

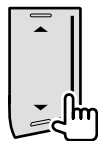

DDX718WBTL
DMX718WBTL

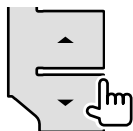

You can adjust the volume (00 to 40) by pressing ▲ to increase and pressing ▼ to decrease.

- Holding ▲ increases the volume continuously to level 15.

DDX595/DDX575BT

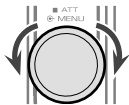

You can adjust the volume (00 to 40) by turning the knob to the right to increase and to the left to decrease.

Attenuating the sound

(Only for DDX795/DDX775BH/DDX595/DDX575BT/
DDX6018BT/DMX6018BT/DDX718WBTL/
DMX718WBTL)

DDX795
DDX775BH
DDX6018BT
DMX6018BT



DDX595
DDX575BT

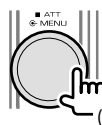

DDX718WBTL
DMX718WBTL

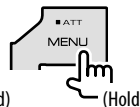

The ATT indicator lights up.

To cancel attenuation: Press and hold the same button again.

Monitor panel operations

(Only for DDX795/DDX775BH/DDX6018BT/
DMX6018BT/DDX718WBTL/DMX718WBTL)

1 Display the <Angle Adjust> screen.

DDX795
DDX775BH
DDX6018BT

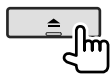

DDX718WBTL

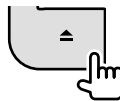

DMX6018BT/DMX718WBTL

Press **MENU** on the monitor panel to display the pop-up short-cut menu, then touch **[Angle]**.

2 Perform the adjustment or operation.

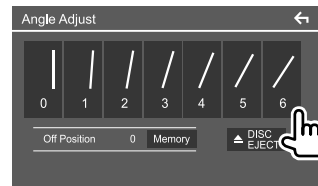

E.g. Angle adjust screen for DDX795

[0] - [6]

Selects a monitor angle.
(The monitor panel will stay in this angle when you turn on the unit.)

<Off Position>

Sets the angle of the monitor panel you want when you turn off the unit or the ignition switch of the vehicle.

- Select the monitor angle, then touch **[Memory]**.

[▲ DISC EJECT]

(Only for DDX795/DDX775BH/
DDX6018BT/DDX718WBTL)
(Touch) Ejects the disc.

To return the monitor panel to the selected angle:
Press ▲ on the monitor panel.

- To return to the previous screen, touch **[←]** on the setting screen.

Getting Started

Initial settings

When you power on the unit for the first time, the **<Initial SETUP>** screen appears.

Perform the initial settings.



E.g. Initial settings screen for DDX795

Once completed, a warning message appears. Touch **[Agree]** to display the Home screen.

[Language]*1

Select the text language used for on-screen information.

Touch **[Language Select]**, then select the language.

- **American English (en)** (Initial)/**British English (en)**/**Nederlands (nl)**/**Français (fr)**/**Deutsch (de)**/**Italiano (it)**/**Español (es)**/**(ar)** العربية/Ελληνικά **(el)**/**Português (pt)**/**Čeština (cs)**/**Polski (pl)**/**Magyar (hu)**/**Русский (ru)** נותור צורה **(th)**/**Türkçe (tr)**/中文 **(zh)**/**(he)** עברית **(fa)** فارسی/**Bahasa Melayu (ms)**/**Bahasa Indonesia (id)**

[Clock] (Page 8)

Set the calendar and clock time.

Make the settings for **[Clock]**, **[Time Zone]** or **[Clock Adjust]**.

[Display] (Page 51)

Make the settings to adjust the display.

[Camera] (Page 53)

Make the settings to display the picture from the connected view camera.

[OEM SETUP]*2 (Page 50)

Confirm the information about/change the settings for using the ADS adapter.

[DEMO]

- **ON** (Initial): Activates the display demonstration.
- **OFF**: Deactivates the display demonstration.

*1 Only for DDX795/DDX775BH/DDX6018BT/DDX5018BT/DDX595/DDX575BT/DDX718WBTL: "Please Power Off" appears when the setting is changed. To enable the change:

- When **<Manual Power Off>** is set to **[AV OFF]**, turn off the ignition switch, then turn on the ignition switch.
- When **<Manual Power Off>** is set to **[Complete OFF]**, turn off the power of the unit, then turn on the power of the unit.

*2 Only for DDX795/DDX775BH/DDX595/DDX575BT.

Setting the security function

■ Registering a security code

(Only for DDX6018BT/DMX6018BT/DDX5018BT/DDX718WBTL/DMX718WBTL)

You can set a security code (four-digit number of your choice) to protect your receiver system against theft. Once you set the security code, you are required to input the security code when the power is on to reconnect the battery.

1 Display the Home screen.

DDX6018BT
DMX6018BT

DDX5018BT

DDX718WBTL
DMX718WBTL



2 Display the **<Security Code Set>** screen.

On the Home screen, touch as follows:



Then, on the **<SETUP>** screen, touch as follows:

[Security] → **[Security Code Set]**

3 Enter a four-digit number (1), then confirm the entry (2).



- To clear the last entry, touch **[BS]**.
- To cancel the setting, touch **[←]**.

4 Enter the four-digit number entered in step 3 and touch **[Enter]** again to confirm your security code.

To change the security code: Touch **[Security Code Change]** on the **<Security>** screen on step 2, then repeat steps 3 and 4.

To clear the security code: Touch **[Security Code Cancellation]** on the **<Security>** screen on step 2, then repeat step 3.

Getting Started

■ Activating the security function

(Only for DDX5018BT/DDX595/DDX575BT)

You can activate the security function to protect your receiver system against theft.

1 Display the <Security> screen.

On the Home screen, touch as follows:



Then, on the <SETUP> screen, touch [Security].

2 Activate the security function.

On the <Security> screen, touch [SI] to select [ON].

The security indicator on the monitor panel flashes when the vehicle ignition is off.

To deactivate the security function: Touch [SI] to select [OFF] in step 2.

Calendar/clock settings

1 Display the Home screen.

DDX795
DDX775BH
DDX6018BT
DMX6018BT



DDX5018BT
DDX595
DDX575BT



DDX718WBTL
DMX718WBTL



2 Display the <User Interface> screen.

On the Home screen, touch as follows:



Then, on the <SETUP> screen, touch [User Interface].

3 Set the date and clock.

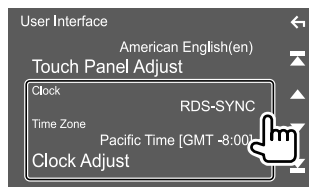

[Clock]

Select the method to set the date and clock.

- **RDS-SYNC** (Initial): Synchronizes the clock with the FM RBDS.
- **Manual**: Sets the date and clock manually.

[Time Zone]*

Select the time zone for your area.

[Clock Adjust]*

Set the date and clock manually when [Clock] is set to [Manual].

Touch [▲]/[▼] to adjust the date (year/month/date), then clock (hour/minute). To finish setting, touch [Set].

* Available when [Clock] is set to [Manual].

Various Screens and Operations

You can display or change to other screens at any time to show information, change the AV source, change the settings, etc.

Touch screen operations

To perform operations on the screen, you need to touch, touch and hold, flick or swipe to select an item, display setting menu screen or to change the page, etc.

Touch

Touch the screen gently to select an item on the screen.



Touch and hold

Touch the screen and keep your finger in place until the display changes or a message is displayed.



Flick

Slide your finger to the left or right on the screen to change the page.



Swipe

Slide your finger up or down on the screen to scroll the screen.



Various Screens and Operations

Home screen

When you turn on the power for the first time, the Home screen appears.

- You can customize the Home screen.
- To display the Home screen from other screens, press **HOME** on the monitor panel.

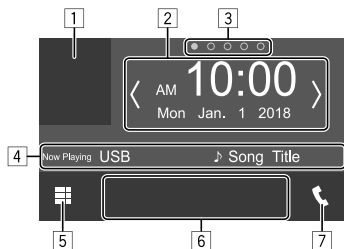

E.g. Home screen for DDX795

Touching the operation keys performs the following actions:

- Displays the current playing source control screen
- For DDX795/DDX775BH/DDX595/DDX575BT: Widget
 - You can change the widget by touching [<]/[>] or flicking left or right on the widget area.
 - Touch the widget to display the detailed screen.
 For DDX6018BT/DMX6018BT/DDX5018BT/DDX718WBTL/DMX718WBTL: Clock/date
- Page indication for widgets*
- Current source information
- Displays all playback sources and options
- Short-cut playback source keys
- Displays the phone control screen

* Only for DDX795/DDX775BH/DDX595/DDX575BT.

Available playback sources and options

- For sources and information displayed when an ADS adapter is connected, see page 39.*1

Touch [5] to display the source/option selection screen.

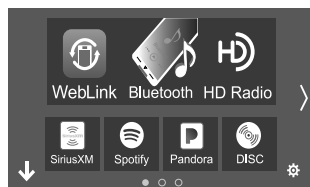

E.g. Source/option selection screen for DDX795

Touching the operation keys performs the following actions:

[WebLink]	Switches to the WebLink™ application.
[Bluetooth]	Plays a Bluetooth audio player.
[HD Radio]*2	Switches to the HD Radio or the conventional radio broadcast.
[Radio]*3	Switches to the conventional radio broadcast.
[SiriusXM]*1	Switches to the SiriusXM® radio broadcast.
[Spotify]	Switches to the Spotify application.
[Pandora]*1	Switches to the Pandora broadcast.

[DISC]*4	Plays a disc.
[iPod]	Plays an iPod/iPhone.
[USB]	Plays files on a USB device.
[AV-IN]*5	Switches to an external component connected to the AV-IN input terminal.
[Audio]	Displays the sound adjustment screen.
[STANDBY]	Puts the unit in standby.
[NAV]*5	Displays the navigation screen when a navigation unit is connected.
[⚙️]	Displays the <SETUP> screen.

To change the page: Touch [<]/[>]. Current page is shown by the page indication on the bottom of the screen.

To return to the Home screen: Touch [↓] on the source/option selection screen.

- *1 Only for DDX795/DDX775BH/DDX595/DDX575BT.
- *2 Only for DDX795/DDX775BH.
- *3 Only for DDX6018BT/DMX6018BT/DDX5018BT/DDX595/DDX575BT/DDX718WBTL/DMX718WBTL.
- *4 Only for DDX795/DDX775BH/DDX6018BT/DDX5018BT/DDX595/DDX575BT/DDX718WBTL.
- *5 Only for DDX6018BT/DMX6018BT/DDX5018BT/DDX718WBTL/DMX718WBTL.

Various Screens and Operations

■ Customizing the source/option selection screen

You can arrange the items to display on the source/option selection screen.

1 Select an item to move.

Touch and hold the item you want to move until boxes appear around the icons.

2 Drag the selected item to the position you want to move it to.

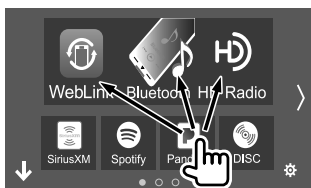

E.g. Source/option selection screen for DDX795

About short-cut playback source keys on the Home screen

The three items displayed on the top of the source/option selection screen with large icons are also shown on the Home screen as the short-cut playback source keys. You can set the source keys which you use frequently and access quickly from the Home screen.

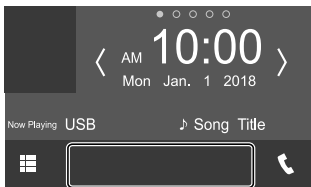

Source control screen

You can perform the playback operation from the source control screen during playback.

- The operation keys and information displayed vary depending on the selected source/disc type/file type being played.
- If the operation keys are not displayed on the screen, touch the screen to show them.

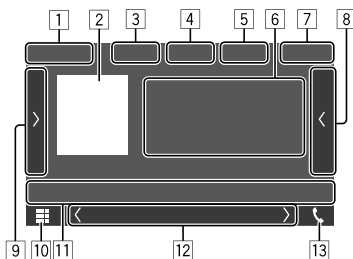

E.g. Common audio playback source screen for DDX795

- 1 Playback source or media type
- 2 Picture data/artwork (shown if the file contains artwork except for disc playback)
- 3 For video: Hides the operation buttons on the screen while video is played
 - Touch the screen to restore the operation buttons.
- 4 Repeat/random playback mode keys*1
- 5 Information about connected device
 - For Bluetooth device: Signal strength and battery level (only when the information is acquired from the device)

- 6 Track/file/song/video information
 - Touching [←] scrolls the text if not all of the text is shown.
- 7 Clock display
- 8 Displays the track/file/station/channel list
- 9 Displays/hides other available operation keys*1
- 10 Displays the source/option selection screen
- 11 Operation keys*1
- 12 Secondary screen

Each time you touch [⏪/⏩], the items shown on the secondary screen change as follows:

- Indicators: Displays the current source conditions, etc.

The followings are the common indicators:

- **ATT**: The sound is attenuated.
- **LOUD**: The loudness is active.
- **IN**: A disc is inserted.
- **MUSIC/VIDEO**: Music/video file is played back.

- Short-cut buttons: Changes the source from those you have located on the Home screen.
- Current source information while the navigation screen is displayed: Touching the information area displays the source control screen.*2

- 13 Displays the phone control screen

*1 See “Common operation keys on source control screen” on page 11.

*2 Only for DDX6018BT/DMX6018BT/DDX5018BT/DDX718WBTL/DMX718WBTL.

Various Screens and Operations

Common operation keys on source control screen

- The appearance of the operation keys may differ, however the similar operation keys have the same operations.
- Available operation keys differ depending on the selected source or connected device.

Touching the operation keys performs the following actions:

[4]

[⏮]*

Selects repeat playback mode.

- : Repeat one
- : Repeat folder
- ALL: Repeat all
- CAP: Repeat chapter
- TIT: Repeat title
- (gray): Off

[X]*

Selects random playback mode.

- : Random folder
- ALL: Random all
- (gray): Off

[9]

[>]

Displays other available operation keys besides those shown on [11].

- To hide the window, touch [◀].

[◀◀][▶▶]

Reverses/forwards search during playback.

[◀|▶]

Plays in slow-motion.

[■]

Stops playback.

[SETUP]

Displays the setting screen of the current playback source.

[MENU CTRL]

Displays the video menu control screen. (Page 15)

[▶][+]

Selects a folder.

[Audio]

Changes the audio output channel of VCD.

[11]

[📊]

Displays the <Graphic Equalizer> screen.

[Q]

Displays the folder list/track list/audio menu/video menu.

[◀◀|▶▶]

- (Touch) Selects an item (chapter/folder/track/audio file/video file).
- (Hold) Reverses/forwards search.
- (Hold) Plays in slow-motion while paused for video playback.

[▶||]

Starts/pauses playback.

* About playback mode:

- Available playback mode differs depending on the source, disc/file type, connected device, etc.
- You cannot activate repeat playback mode and random playback mode at the same time.

Using the pop-up short-cut menu

While displaying the source control screen, you can jump to another screen by touching the operation keys on the pop-up short-cut menu.

1 Display the pop-up short-cut menu.

DDX795
DDX775BH
DDX6018BT
DMX6018BT

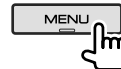

DDX5018BT



DDX595
DDX575BT

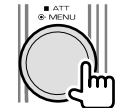

DDX718WBTL
DMX718WBTL

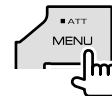

Various Screens and Operations

2 Select an item to jump.

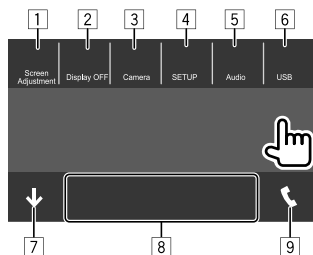

E.g. Pop-up short-cut menu screen for DDX795

- 1 Displays the picture adjustment screen. (Page 15)
- 2 Turns off the screen.
- 3 **Camera** (for DDX795/DDX775BH/DDX6018BT/DDX718WBTL/DDX5018BT/DDX595/DDX575BT): Displays the picture from the connected rear view camera. (Page 36)
Angle (for DMX6018BT/DMX718WBTL): Displays the <Angle Adjust> screen. (Page 6)
- 4 Displays the <SETUP> screen. (Page 50)
- 5 Displays the sound adjustment screen.
- 6 Displays the current source control screen.
- 7 Closes the pop-up short-cut menu.
- 8 Changes the playback source.
 - The three short-cut playback source keys displayed on the Home screen are displayed on the short-cut menu.
- 9 Displays the phone control screen. (Page 43)

■ Using touch screen operation during playback

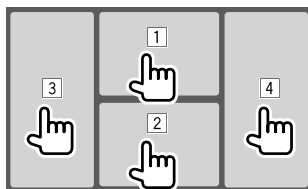

Touching the areas performs the following actions:

- 1 Displays the video control menu while playing a video.
- 2 Displays the source control screen.
- 3 Goes to the previous chapter/track.*
- 4 Goes to the next chapter/track.*

* Not available for video from an external component (AV-IN) (for DDX6018BT/DMX6018BT/DDX5018BT/DDX718WBTL/DMX718WBTL).

List/setting screen

The followings are the common operation keys which appear on the list/settings screen.

- The appearance of the operation keys may differ, however the similar operation keys have the same operations.
- Available operation keys differ depending on the setting screens. Not all the following operation keys are shown on every screen.

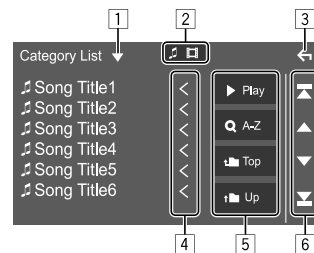

Touching the operation keys performs the following actions:

- 1 Displays list type selection window.
- 2 Selects the file type ([🎵]: audio/[📺]: video).
- 3 Exits from the current screen or returns to the previous screen.
- 4 Scrolls the text if not all of the text is shown.
- 5 Play/search keys
 - [▶ **Play**]: Plays all tracks in the folder containing the current track.
 - [**Q** **A-Z**]: Enters alphabet search to list the items in alphabetical order. When a keypad appears, touch the first letter you want to search for.
 - [**🏠** **Top**]: Returns to the root folder.
 - [**⬆️** **Up**]: Returns to the upper layer.
- 6 Changes the page to display more items.
 - [**⬆️**]/[**⬇️**]: Scrolls the page.
 - [**⬆️**]/[**⬇️**]: Jumps to the top or bottom page.

Disc (Only for DDX795/DDX775BH/DDX6018BT/DDX5018BT/DDX595/DDX575BT/DDX718WBTL)

- If a disc does not have a disc menu, all tracks on it will be played repeatedly until you change the source or eject the disc.
- For playable disc types, file types and other information, see pages 66 and 67.
- If “⊘” appears on the screen, the unit cannot accept the operation you have tried to do.
 - In some cases, without showing “⊘”, operations will not be accepted.
- When playing back a multi-channel encoded disc, the multi-channel signals are downmixed.

Inserting a disc

DDX795/DDX775BH/DDX6018BT/DDX718WBTL:
Press ▲ on the monitor panel to display the <Angle Adjust> screen, touch [▲ DISC EJECT] to open the monitor panel, then insert a disc.

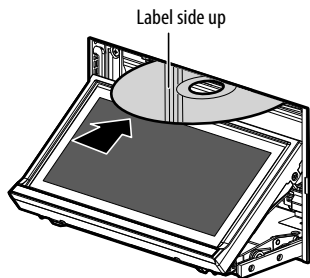

E.g. Inserting a disc for DDX795

- After the disc is loaded, the monitor panel closes automatically.

DDX5018BT/DDX595/DDX575BT:

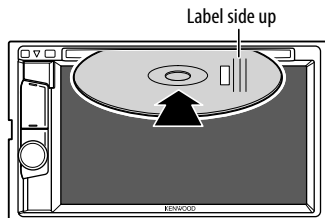

E.g. Inserting a disc for DDX595

The source changes to “DISC” and playback starts.

- The IN indicator lights up while a disc is inserted.

Ejecting a disc

DDX795/DDX775BH/DDX6018BT/DDX718WBTL:
Press ▲ on the monitor panel.

On the <Angle Adjust> screen, then touch as follows:



DDX5018BT/DDX595/DDX575BT:



- When removing a disc, pull it out horizontally.
- You can eject a disc while playing another AV source.
- If the ejected disc is not removed within 15 seconds, the disc is automatically inserted again into the loading slot to protect it from dust.

To close the monitor panel (only for DDX795/DDX775BH/DDX6018BT/DDX718WBTL):

After removing the disc, press ▲ on the monitor panel.

Playback operations

Audio playback information and key operation

- For playback information, see “Source control screen” on page 10.
- For key operations on the touch panel, see “Common operation keys on source control screen” on page 11.

Selecting a folder/track on the list

1 Display the folder/track list.

On the source control screen, touch as follows:



2 Select the item in the selected folder.

- For details about the list operation, see page 12.

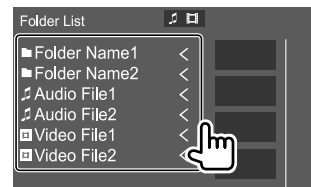

Select an item in each layer until you reach and select the desired file.

Settings for disc playback

- Available items shown on the <DVD SETUP> screen differ depending on the type of disc/file being played back.

1 Display the <DVD SETUP> screen.

On the source control screen, touch as follows:



2 Make the settings.



[Menu Language]*

Select the initial disc menu language. (Initial:

English)

[Subtitle Language]*

Select the initial subtitle language or turn subtitles off (**OFF**). (Initial: **English**)

[Audio Language]*

Select the initial audio language. (Initial: **English**)

<Dynamic Range Control>

You can change the dynamic range while playing Dolby Audio encoded discs.

- Wide:** Reproduces powerful sound at a low volume level with its full dynamic range.
- Normal:** Reduces the dynamic range a little.
- Dialog** (Initial): Reproduces movie dialog more clearly.

<Screen Ratio>

Select the monitor type to watch a wide screen picture on the external monitor.

16:9 (Initial)

4:3 LB

4:3 PS



* You can change these settings only while DVD is inserted. Select the language on the window, then touch [Close] to finish.

Playback operations

Video playback information on the source control screen

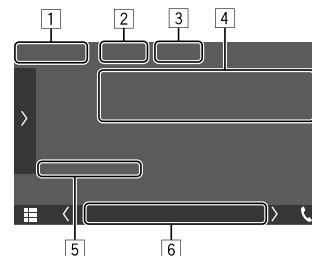

E.g. Video playback source control screen for DDX795

- Media type
- Hides the operation buttons on the screen.
 - Touch the screen to restore the operation buttons.
- Repeat/random playback mode keys
- Current playback item information/audio format
- Playback status/playing time
- Indicators
 - IN:** Lights up when a disc is inserted.
 - VIDEO:** Lights up when video is played.

Video

Video menu control operations

(Only for DDX795/DDX775BH/DDX6018BT/
DDX5018BT/DDX595/DDX575BT/DDX718WBTL)

You can display the video menu control during video playback.

- Available operation keys differ depending on the selected disc type and file type.

1 Display the video menu control screen.

On the source control screen, touch as follows:



2 Perform the video operations.

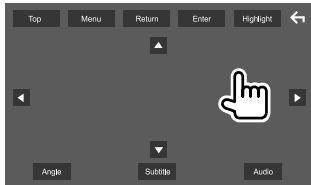

E.g. Video menu control screen for DDX795

Touching the operation keys performs the following actions:

[Top]	Displays the top menu (DVD).
[Menu]	Displays the disc menu (DVD).
[Return]	Returns to the previous screen.
[Enter]	Confirms the selection.
[Highlight]	Switches to the direct disc menu selection mode. Touch the target item to select. <ul style="list-style-type: none">• The menu screen disappears when no operation is done for 5 seconds.
[←]	Returns to the playback screen.
[Angle]	Selects the view angle.
[Subtitle]	Selects the subtitle type.
[Audio]	Selects the audio type.
[▲] [▼] [◀] [▶]	Selects an item.

Adjusting the picture

1 Display the pop-up short-cut menu.

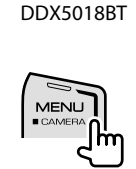

2 Display the picture adjustment screen.

On the pop-up short-cut menu, touch as follows:

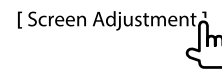

3 Adjust the picture.

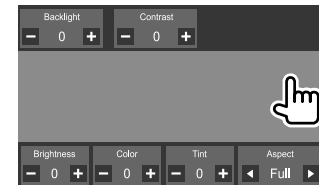

Video

<Backlight>	Adjusts the brightness of the backlight. (-4 to +4)
<Contrast>	Adjusts the contrast. (-4 to +4)
<Brightness>	Adjusts the brightness. (-4 to +4)
<Color>*1	Adjusts the color. (-4 to +4)
<Tint>*2	Adjusts the tint. (-4 to +4)
<Aspect>	Selects the aspect ratio. <ul style="list-style-type: none">• Full: Changes the aspect ratio of video and displays fully on the screen.• Normal: Displays the video in the aspect ratio of 4:3.• Auto*3:<ul style="list-style-type: none">– For discs: Video of 16:9 ratio is displayed in the aspect ratio of <Full> setting. Video of 4:3 ratio is displayed in the aspect ratio of <Normal> setting.– For USB: Displays the video fully on vertical or horizontal with no ratio change.

- Adjustable items are different depending on the current source.
- You can perform this function only when you have applied the parking brake.

- *1 Adjustable only during playback.
*2 Available only when the "AV-IN" or camera screen is displayed.
*3 Selectable only when video from a disc or USB device is played back.

USB

You can connect a USB mass storage class device such as a USB memory, digital audio player, etc. to the unit.

- For playable file types and other information, see pages 66 and 69.
- You cannot connect a PC or portable HDD to the USB input terminal.
- You cannot connect a USB device via a USB hub.

Connecting a USB device

- Use CA-U1EX for extending the cable if necessary. (Max 500 mA, 5V)

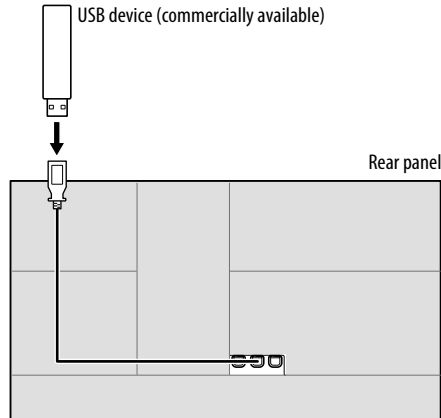

- Only for DMX718WBTL: The unit is equipped with two USB input terminals. You can connect two USB devices.

Playback operations

Playback information and key operation

- For playback information, see "Source control screen" on page 10.
- For key operations on the touch panel, see "Common operation keys on source control screen" on page 11.
- All tracks in the USB device will be played repeatedly until you change the source or disconnect the USB device.

Additional keys operations: Touching the operation keys performs the following actions.

[USB DEVICE CHANGE]* Switches to another USB device when two USB devices are connected.

* Only for DMX718WBTL.

■ Selecting a folder/track on the list

1 Display the folder/track list.

On the source control screen, touch as follows:



2 Select the list type.



3 Select the desired track.

- Repeat the procedure until you select the desired track.
- For details about the list operation, see page 12.

From <Category List>:

- ① Select the file type ([🎵]: audio/[📺]: video).
- ② Select a category, then the item in the selected category.

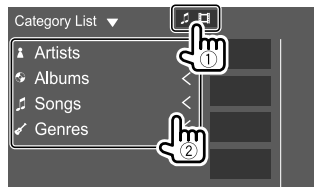

From <Link Search>:

- ① Select the file type ([🎵]: audio/[📺]: video).
- ② Select the tag type to display a list of contents that contains the same tag as the track/file currently being played, then select the item.

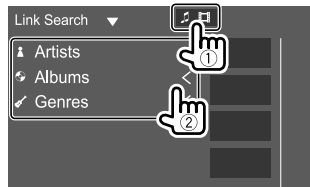

From <Folder List>:

Select the folder, then the item in the selected folder.

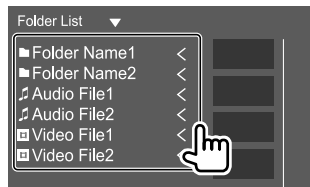

iPod/iPhone

Connecting an iPod/iPhone

- For playable iPod/iPhone types and other information, see page 69.
- You cannot watch video.

Wired connection

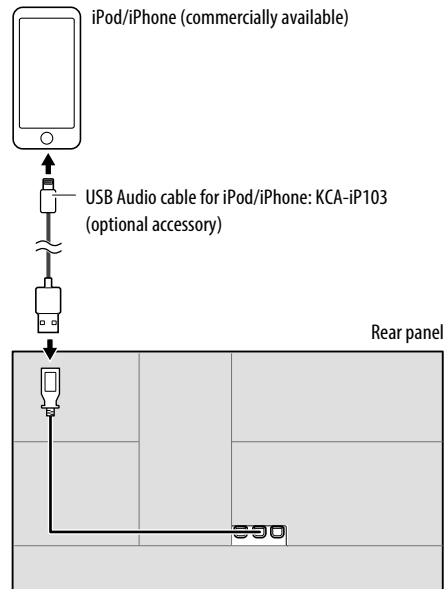

- For DMX718WBTL: You cannot connect two iPod/iPhone at the same time.

Bluetooth connection

Pair the iPod/iPhone with this unit via Bluetooth. (Page 40)

Playback operations

■ Playback information and key operation

- For playback information, see “Source control screen” on page 10.
- For key operations on the touch panel, see “Common operation keys on source control screen” on page 11.

■ Selecting an audio file from the menu

1 Display the list.

On the source control screen, touch as follows:



2 Select the list type.



3 Select the desired track.

- Repeat the procedure until you select the desired track.
- For details about the list operation, see page 12.

From <Category List>:

Select a category, then the item in the selected category.

- Available categories differ depending on the type of iPod/iPhone.

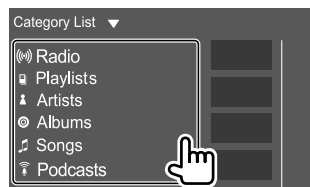

From <Link Search>:

Select the tag type to display a list of contents that contain the same tag as the track/file currently being played, then select the item.

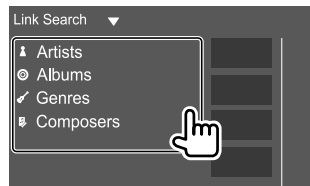

Apps—WebLink™

You can display and control the App on the unit while your smartphone is connected to the USB input terminal.

Preparation: Be sure to ground the PRK SW lead. (Pages 63 – 65)

Available Apps

You can use the following Apps on this unit. Install the WebLink™ App on your smartphone beforehand.

WebLink™

WebLink™ enables you to use the following Apps with the unit.

- Media Player
- Yelp
- YouTube
- OpenWeatherMap

For DMX718WBTL

To use WebLink™ App on iPhone, connect the iPhone to USB1 input terminal.

- WebLink™ App does not work on iPhone connected to USB2 input terminal.

Connecting a smartphone

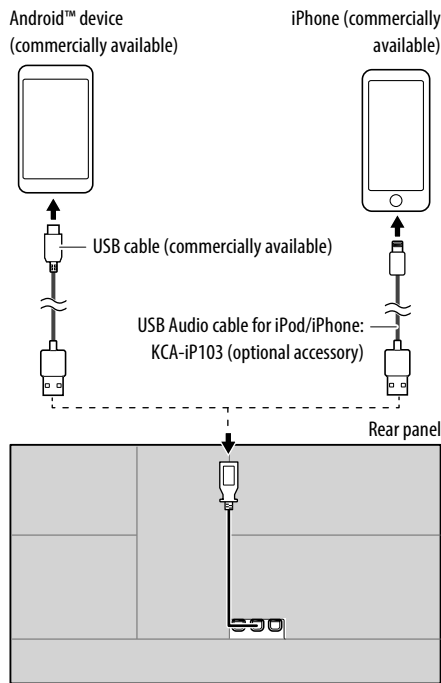

- When the smartphone is connected to the unit and “WebLink” is selected as the source, a confirmation message to communicate with each other appears on the smartphone. Touch **[Allow]** to establish connection, or **[Ignore]** to cancel the connection.
- You can check the connection status on the WebLink™ screen on your smartphone.

Start playback

1 Select “WebLink” as the source.

2 Operate on the unit to select App.

- On the “WebLink” source screen, you can also operate on the touch panel as follows:



- Displays the main menu of the “WebLink” source screen.
- Exits the current App.



- Returns to the previous screen.
- Exits the current App.

3 Operate on your smartphone.

- When you are asked to communicate between your smartphone and the unit, touch **[Allow]** to proceed.
- If App does not start while using “WebLink”, start the App on your smartphone.

Switching to the App screen while listening to the another source

You can display the App screen while listening to the other source.

DDX795
DDX775BH
DDX6018BT
DMX6018BT



DDX5018BT
DDX595
DDX575BT



DDX718WBTL
DMX718WBTL



HD Radio™ tuner

(Only for DDX795/DDX775BH)

About HD Radio™ Technology

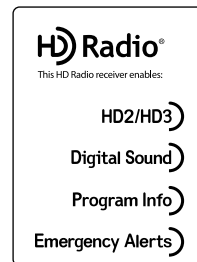

HD2/HD3

Adjacent to traditional main stations are HD2/HD3 Channels, providing new original formats on the FM dial

Digital Sound

HD Radio broadcasts deliver crystal-clear, CD-like digital audio quality to consumers

Program Info

Provides song name, artist, station ID, and other relevant data to enrich the listening experience

Emergency Alerts

Delivers critical and life-saving messages to the public during emergency situations

Listening to the HD Radio™ broadcast

Playback information on the source control screen

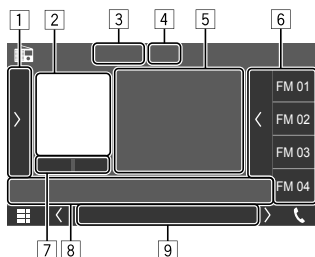

E.g. HD Radio source control screen for DDX795

- 1 Displays/hides other available operation keys*
- 2 Picture or station logo if available
- 3 Changes the seek mode for [◀◀]/[▶▶]
 - **AUTO1** (Initial): Auto search
 - **AUTO2**: Tunes in preset stations one after another
 - **MANUAL**: Manual search
- 4 HD indicator
 - When receiving a digital HD radio broadcast, the HD indicator lights up in orange.
 - When receiving an analog HD radio broadcast, the HD indicator lights up in gray.
 - When receiving a conventional radio broadcast, the HD indicator is turned off.

- 5 Text information
 - Touching [◀] scrolls the text if not all of the text is shown.
 - Touching [⊙] switches the information (e.g. frequency, channel no., station name, artist, etc.).
 - The availability of the information vary depending on the reception, selected station or channel.
- 6 Preset list
- 7 Selects the band (AM/FM)
- 8 Operation keys*
- 9 Indicators
 - **MC**: Lights up when receiving an HD Radio multicast channel.
 - **DIGITAL**: Lights up when receiving digital signals.
 - **ANALOG**: Lights up when receiving analog signals.
 - **EA**: Indicates the status of the emergency alert as follows:
 - Lights in white: The current station supports the emergency alert.
 - Lights in orange: Receives the emergency alert or snoozes/ignores the reception.
 - Turns off : Emergency alert is deactivated.
 - **ST**: Lights up when receiving stereo broadcast.

* See the following "Operation keys on source control screen".

Operation keys on source control screen

- The appearance of the operation keys may differ, however the similar operation keys have the same operations.
- See also "Common operation keys on source control screen" on page 11.

Touching the operation keys performs the following actions:

1	
[10Key Direct]	Displays the direct station/channel search screen.
[PTY]	(For FM RBDS features) Enters PTY search mode. <ol style="list-style-type: none"> ① Touch a PTY code to search for. ② Touch [Search]. If there is a station broadcasting a program of the same PTY code as you have selected, that station is tuned in.
[AME]	Presets stations automatically.
[RCV]	Changes the HD Radio reception mode. <ul style="list-style-type: none"> • AUTO: Switch between digital and analog audio automatically. • Digital: Select this to tune into digital audio only. • Analog: Select this to tune into analog audio only.
[Emergency Alerts]	Activates/deactivates the reception of the emergency alert message.
[Alert Message Log]	Displays the received emergency alert message list.

8

[<<<|/|>>>] Searches for a station.
 • The search method differs according to the selected seek mode (see page 20).

[CH▼]/
[CH▲] Selects a sub-channel when receiving an HD Radio multicast channel.

■ Selecting a station/channel by specifying frequency/channel number—Direct Search

You can search for a station by entering the desired frequency or channel number.

1 Display the <10Key Direct> screen.

On the source control screen, touch as follows:

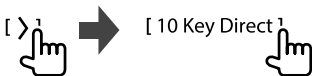

2 Select a search method ([FREQ]: by frequency/[CH]: by channel) (①), enter the frequency or channel number (②), then start searching (③).

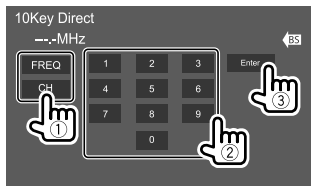

• Touch [BS] to delete the last entry.

Storing preset stations in the memory

You can preset 15 stations for FM and 5 stations for AM.

■ Automatic presetting — AME (Auto Memory)

1 Select the band.

On the source control screen, touch as follows:

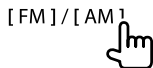

2 Start automatic presetting.



A confirmation message appears. Touch [Yes]. The local stations with the strongest signals are found and stored automatically.

■ Manual presetting

1 Select the band, then tune in to a station you want to store.

• See “Playback information on the source control screen” on page 20 for details.

2 Display the preset list.

On the source control screen, touch as follows:



3 Select a preset number to store into.

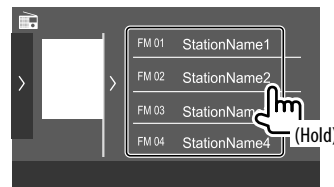

The station selected in step 1 is stored into the preset number you have selected.

To hide the preset list: Touch [>] on the preset list.

Selecting a preset station

1 Select the band, then display the preset station list.

On the source control screen, touch as follows:



2 Select a preset station.

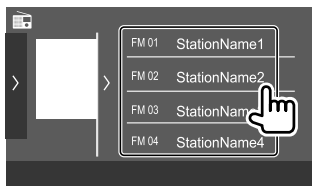

To hide the preset list: Touch [>] on the preset list.

Receiving emergency alert

You can receive an emergency alert message while listening to another source.

Activating emergency alert reception

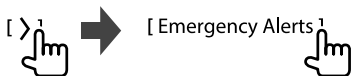

Receiving emergency alert

When you receive an emergency alert message, the following screen is displayed.

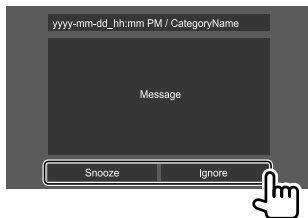

[Snooze] The same emergency alert message will not interrupt again for 10 minutes.

[Ignore] The same emergency alert message will not interrupt again for 12 hours.

Displaying the received emergency alert messages

You can check the emergency alert messages up to 10.

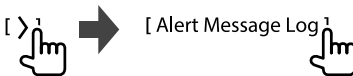

Radio

(Only for DDX6018BT/DMX6018BT/DDX5018BT/DDX595/DDX575BT/DDX718WBTL/DMX718WBTL)

Listening to the radio

Playback information on the source control screen

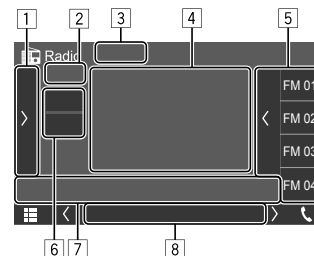

E.g. Radio source control screen for DDX6018BT

- 1 Displays/hides other available operation keys*
- 2 Preset no.
- 3 Changes the seek mode for [◀◀]/[▶▶]
 - **AUTO1** (Initial): Auto search
 - **AUTO2**: Tunes in preset stations one after another
 - **MANUAL**: Manual search

* See the "Operation keys on source control screen" on page 23.

Radio

4 Text information

- Touching [◀] scrolls the text if not all of the text is shown.
- Touching [⊕] switches the information (e.g. frequency, PS name, Radio Text, title, artist, etc.).
 - The availability of the information vary depending on the reception, selected station.

5 Preset list

6 Selects the band (AM/FM)

7 Operation keys*

8 Indicators

- **TI**: Lights up in white when receiving the traffic information, and lights in orange when being standby for Traffic Information Reception.
- **ST**: Lights up when receiving stereo broadcast.
- **MONO**: Lights up when receiving stations in monaural forcibly.

* See the following “Operation keys on source control screen”.

Operation keys on source control screen

- The appearance of the operation keys may differ, however the similar operation keys have the same operations.
- See also “Common operation keys on source control screen” on page 11.

Touching the operation keys performs the following actions:

1

[TI]*

(For FM RBDS features)

- Activates TI standby reception mode.
- When TI is activated, the unit is ready to switch to traffic information if available. The TI indicator lights up in white.
 - If the TI indicator lights up in orange, tune into a station providing Radio Broadcast Data System signals.
 - The volume adjustment for traffic information is automatically memorized. The next time the unit switches to traffic information, the volume is set to the memorized level.
 - To deactivate, touch [TI] again.

[MONO]*

Activates monaural mode for better FM reception (stereo effect will be lost).

- The MONO indicator lights up while monaural mode is activated.
- To deactivate, touch [MONO] again.

[PTY]*

(For FM RBDS features)

Enters PTY search mode.

- ① Touch a PTY code.
- ② Touch [Search] to search for.

If there is a station broadcasting a program of the same PTY code as you have selected, that station is tuned in.

[AME]

Presets stations automatically.

7

[◀▶]/[▶▶]

Searches for a station.

- The search method differs according to the selected seek mode.

* Appears only when FM is selected as the source.

Storing preset stations in the memory

You can preset 15 stations for FM and 5 stations for AM.

Automatic presetting — AME (Auto Memory)

On the source control screen, touch as follows:



A confirmation message appears. Touch [Yes]. The local stations with the strongest signals are found and stored automatically.

Manual presetting

1 Select the band, then tune in to a station you want to store.

- See “Playback information on the source control screen” on page 22 for details.

2 Display the preset list.

On the source control screen, touch as follows:



3 Select a preset number to store into.

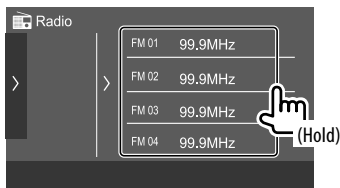

The station selected in step 1 is stored into the preset number you have selected.

To hide the preset list: Touch [>] on the preset list.

Selecting a preset station

1 Select the band, then display the preset station list.

On the source control screen, touch as follows:



2 Select a preset station.

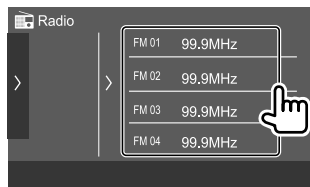

To hide the preset list: Touch [>] on the preset list.

SiriusXM® Satellite Radio

(Only for DDX795/DDX775BH/DDX595/DDX575BT)

Only SiriusXM® brings you more of what you love to listen to, all in one place. Get over 140 channels, including commercial-free music plus the best sports, news, talk, comedy and entertainment. Welcome to the world of satellite radio. A SiriusXM Connect Vehicle Tuner and subscription are required.

For more information, visit <www.siriusxm.com>.

Preparation

Connecting the SiriusXM Connect Vehicle Tuner

Perform this installation when you install the unit for the first time.

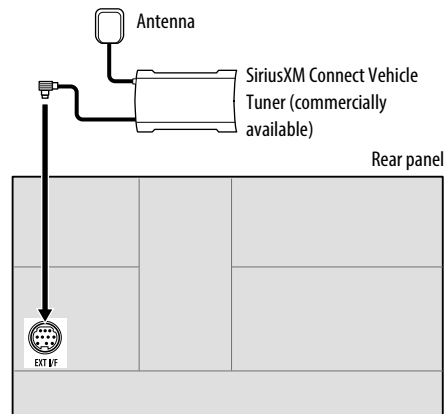

- For more information to install the SiriusXM Connect Vehicle Tuner, refer to the installation manual supplied with the tuner.

■ Activating subscription

1 Check your Radio ID.

The SiriusXM Satellite Radio ID is required for activation and can be found by tuning to Channel 0 as well as on the label found on the SiriusXM Connect Vehicle Tuner and its packaging.

- The Radio ID does not include the letters I, O, S or F.

2 Activate the subscription.

For users in the U.S.A:

- Online: Visit <www.siriusxm.com/activatenow>
- Phone: Call SiriusXM Listener Care at 1-866-635-2349

For users in Canada:

- Online: Visit <www.siriusxm.ca/subscribe-now>
- Phone: Call XM Customer Care at 1-877-438-9677

3 Confirm the activation.

A confirmation message appears. Touch **[Return]**.

■ Listening to the SiriusXM® Satellite Radio

■ Playback information on the source control screen

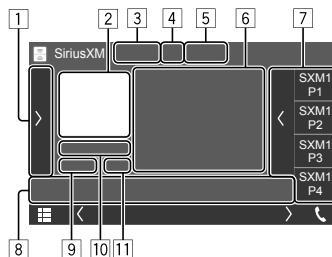

E.g. SiriusXM Satellite Radio source control screen for DDX795

- 1 Displays/hides other available operation keys*1
- 2 Album art
- 3 Changes the seek mode for **[CH▲]**/**[CH▼]**
 - **SEEK1** (Initial): Skips to another available channel.
 - **SEEK2**: Skips to another preset channel.
- 4 Signal strength indicator
- 5 SiriusXM® Satellite Radio indicators
 - **Scan**: Lights up when TuneScan™ is activated. (Page 28)
 - : Indicates the status of traffic and weather information standby reception. (Page 30)

- 6 Text information
 - Touching **[<]** scrolls the text if not all of the text is shown.
 - Touching **[⊞]** switches the information (e.g. channel name, artist name, song title, content information, etc.).
 - The availability of the information vary depending on the reception, selected channel.
 - Touching **[♪+]**/**[♪+]** registers the artist/song for content alert. (Page 28)
- 7 Preset list
- 8 Operation keys*1
- 9 Replay timer bar for replay mode*2
 - Gray: The remaining capacity
 - Blue: The amount of buffered content
- 10 Current channel information (band/preset no./channel no.)
- 11 Playback status and time code for the buffered data and replay mode*2
 - The time code shows you the point in the Replay buffer you are listening to. (E.g. “-5:00” means that you are listening to audio that is 5 minutes behind the current broadcast.)

*1 See “Operation keys on source control screen” on page 26.

*2 Appears while playing a buffered content.

SiriusXM® Satellite Radio

Operation keys on source control screen

- See also “Common operation keys on source control screen” on page 11.

Touching the operation keys performs the following actions:

[1]	
[Direct Channel]	Displays the <Direct Channel> screen.
[SETUP]	Displays the <SiriusXM SETUP> screen.
[Band]	Selects the band (SXM1/SXM2/SXM3/SXM4).
[Replay]/[Live]	Switches between replay mode screen and live mode screen.
[Traffic & Weather]	Activates or deactivates the traffic & weather alert.
[Tune Scan]	Starts TuneScan™.

[8]	
[Q]	Displays the category/channel search screen.
[▶▶]	Starts/pauses the content replay.
[◀◀]/[▶▶]	(Touch) Skips to the previous or next track while playing buffered content.*1*2
[◀◀]/[▶▶]	(Hold) Rewinds or fast forwards.*1

[CH▲]/[CH▼] Selects the channel.

- To select a channel, make sure “SEEK1” is selected as the seek mode.
- To select only preset channels, make sure “SEEK2” is selected as the seek mode.

*1 Appears while playing a buffered content.

*2 Appears during TuneScan™.

Selecting a channel

To select a channel by specifying a channel number

1 Display the <Direct Channel> screen.

On the source control screen, touch as follows:

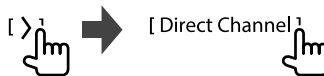

2 Enter the channel number (①), then touch [Enter] (②) to search.

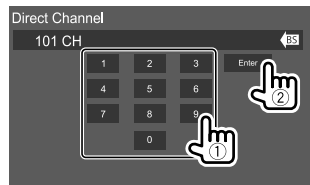

- To clear the last entry, touch [BS].

To select a channel on the category/channel list

You can obtain information on channels or select a channel to listen to.

1 Display the <Category List> screen.

On the live mode screen, touch as follows:



2 Select a category.

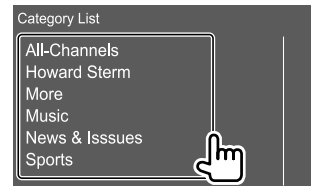

3 Select a channel.



- To switch the information on the list (channel name/artist name/song title/content information), touch [Info Change].

Storing preset channels in the memory

You can preset six channels for each band.

1 Tune in to a channel you want to store.

- See “Playback information on the source control screen” on page 25 for details.

2 Display the preset list.

On the source control screen, touch as follows:



3 Select a preset number to store into.

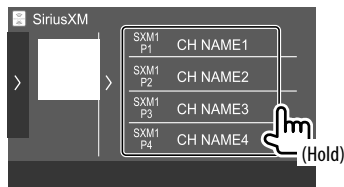

The channel selected in step 1 is stored into the preset number you have selected.

To hide the preset list: Touch [>] on the preset list.

Selecting a preset channel

1 Select the band.

On the source control screen, touch as follows:



2 Display the preset list.

On the source control screen, touch as follows:



3 Select a preset channel.

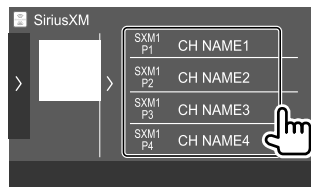

To hide the preset list: Touch [>] on the preset list.

Replay

You can pause, rewind and replay the content from the currently tuned channel.

- The SiriusXM Connect Vehicle Tuner continually buffers up to 60 minutes of audio.
- If you change to another channel during playback, the buffered contents will be lost.
- The time code is updated every second.

1 Display the replay mode screen.

On the source control screen, touch as follows:



- You can also display the replay mode screen by touching [▶||].

2 Perform the replay operations.

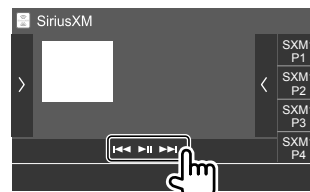

[▶||] Starts/pauses playback.

[|◀◀|/▶▶|] (Touch) Skips the current track/segment.

- Touching [|◀◀|] within 2 seconds of the beginning of the current track/segment returns to the previous track.
- Touching [|◀◀|] after 2 seconds or more of the current track returns to the beginning of the track.

[|◀◀|/▶▶|] (Hold) Rewinds or fast forwards.

To return to the live position: Touch [>], then touch [Live].

SiriusXM Satellite Radio features

SmartFavorites

User stored channels (P1 to P6) of the current band are recognized as SmartFavorites channels. SiriusXM Connect Vehicle Tuner automatically buffers their broadcast content in the background. When you select a SmartFavorite channel, you can rewind and replay up to 30 minutes of any of the missed news, talk, sports or music content.

- SmartFavorites is available only when you connect an SXV200 or later SiriusXM Connect Vehicle Tuner.
- If you change to another band, the buffered content is cleared and new channels/stored preset channels in the current band will start buffering.

TuneStart™

When you select a SmartFavorites channel, you can listen to the current song from the beginning.

1 Display the <SiriusXM SETUP> screen.

On the source control screen, touch as follows:



2 Activate TuneStart™.

On the <SiriusXM SETUP> screen, touch [TuneStart] to select [ON].

To deactivate TuneStart™: Touch [TuneStart] to select [OFF] in step 2.

TuneScan™

You can get a short preview of the songs you have missed on each of your SmartFavorites music channels and the currently tuned music channel.

Activate TuneScan™ to start scanning the first 6 seconds of the recorded music content.

- TuneScan™ is available only when you connect an SXV200 or later SiriusXM Connect Vehicle Tuner.

On the source control screen, touch as follows:



The unit starts scanning.

- To select the previous/next content, touch [◀◀] or [▶▶].
- To end scanning and continue listening to the current song/content, touch [Tune Scan] again.
- To exit scanning, touch and hold [Tune Scan].

Content Alert

The unit informs you when receiving the content you are interested in such as music and information about a sports team.

Activating Content Alert

1 Display the <SiriusXM SETUP> screen.

On the source control screen, touch as follows:



2 Activate Content Alert.

On <SiriusXM SETUP> screen, touch [Content Alerts] to select [ON].

To deactivate Content Alert: Touch [Content Alerts] to select [OFF] in step 2.

Registering artists/songs for Content Alert

You can register your favorite artists or songs. Up to 60 contents can be registered.

On the source control screen, touch as follows while listening to your favorite artist/song:

[👤+] (Hold) Registers the artist of the current song.

[🎵+] (Hold) Registers the current song.

Once you have registered the artist/song, the icons appear as [👤]/[🎵].

■ Selecting items for Content Alert

You can select items (artists/songs/teams) from the registered items on the list to inform you once the unit receives the information.

- Activate Content Alert by selecting **[ON]** for **[Content Alerts]** on the **<SiriusXM SETUP>** screen beforehand.

1 Display the **<Alert Contents Select>** screen.

On the source control screen, touch as follows:



Then, on the **<SiriusXM SETUP>** screen, touch **[Content Alerts Contents Set]**.

2 Select the desired category.

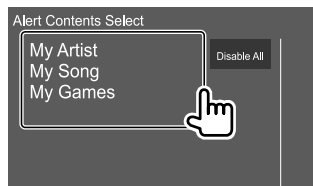

[My Artist] Displays the list of registered artists.

[My Song] Displays the list of registered songs.

[My Games] Displays the list of leagues.

3 Select **[ON]** for content you want to receive alerts for.

For artists/songs:

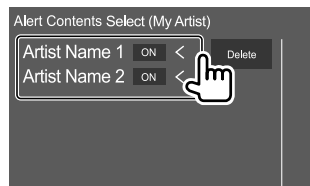

E.g. When selecting **[My Artist]** in step 2

For teams:

- ① Select a league.

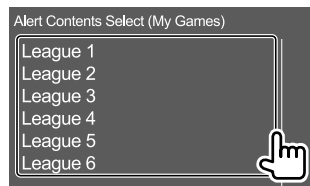

- ② Select **[ON]** for teams you want to receive alerts for.



- Repeat steps ① and ② to select other leagues/teams.

- Select **[OFF]** for the content you want to deactivate the content alert for.
- For artist/songs: you can delete currently registered content from the list by touching **[Delete]**. A confirmation message appears. Touch **[Yes]**.
- For sports teams: you can select up to 30 teams.
- Repeat steps 2 and 3 if you want to set the content alert for other categories.

To deactivate the all selected content: Touch **[Disable All]** in the **<Alert Contents Select>** screen in step 2.

- A confirmation message appears. Touch **[Yes]**.

Switching to registered content

When receiving the content registered for content alerts, an alert appears on the screen. Touch **[Jump]**, then select the item to jump to on the **<Alert Contents List>** screen.

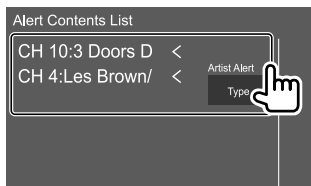

- To cancel the content alerts, touch **[Ignore]**.
- To switch the alert content list (Artist Alert, Song Alert, and Game Alert™), touch **[Type]**.

Traffic & Weather Jump

You can standby for receiving traffic and weather information.

Activating Traffic & Weather Jump

1 Display the **<City Select>** window.

On the source control screen, touch as follows:



Then, on the **<SiriusXM SETUP>** screen, touch **[Traffic Weather City Select]**.

2 Touch **[<]/[>]** to select the city for which you want to receive traffic & weather broadcasts.

3 Activate Traffic & Weather Jump.

On the source control screen, touch as follows:

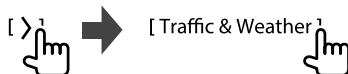

When traffic or weather broadcasts for selected city are detected, the channel is automatically switched.

- Each time you touch **[Traffic & Weather]**, the Traffic & Weather Jump is activated and deactivated. The  indicator color indicates the status of the Traffic & Weather Jump as follows:
 - Lights in white: Traffic & Weather Jump is activated.
 - Lights in purple: Playing.
 - Grays out: Traffic & Weather Jump is deactivated.

Setting reception restrictions

You can limit access to SiriusXM channels, such as those with mature content.

Setting or changing the parental code

- The initial setting is "0000".
- Changing the code does not change the **[Parental Control]/[Parental Lock Channel Selection]** settings.

1 Display the **<Parental Code Set>** screen.

On the source control screen, touch as follows:



Then, on the **<SiriusXM SETUP>** screen, touch **[Parental Code]**.

2 Enter the initial four-digit code (0000) (1), and then touch **[Enter]** (2) to confirm.

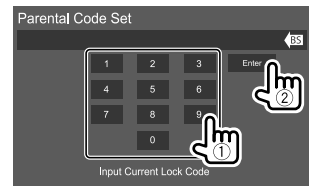

- To clear the last entry, touch **[BS]**.

3 Enter a new four-digit code, then touch **[Enter]** to confirm.

4 Repeat step 3 above to confirm the new code.

■ Activating parental control

You can set the parental control feature to lock any SiriusXM channels or automatically lock all channels classified as “mature” by SiriusXM®.

1 Display the <SiriusXM SETUP> screen.

On the source control screen, touch as follows:



2 Touch [Parental Control] to select the desired mode.

[OFF]	Deactivates parental control.
[Mature]	Locks channels classified as “mature” by SiriusXM®.
[User]	Locks selected channels. (See also the following “Parental Lock channel selection”).

3 Enter the parental code to confirm your selection.

■ Parental Lock channel selection

This option allows you to manually select the channels to be locked by the parental control feature.

- You can only change the setting if [Parental Control] is set to [User].

1 Display the <Parental Lock Channel Selection> screen.

On the source control screen, touch as follows:

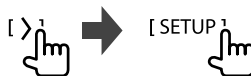

Then, on the <SiriusXM SETUP> screen, touch [Parental Lock Channel Selection].

2 Enter the parental code.

The <Parental Lock Category Select> screen appears.

3 Select a category.

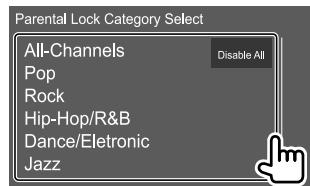

4 Select [ON] for channels you want to activate parental lock for.

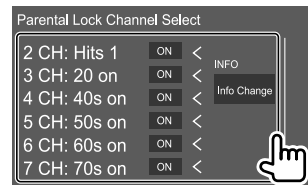

- Select [OFF] for the channels you want to deactivate the parental lock for.
- To switch the information on the list (channel name/artist name/song title/category name/content information), touch [Info Change].

5 Repeat steps 3 and 4 to set the parental lock on multiple channels.

To deactivate the parental lock for all locked channels: Touch [Disable All] in the <Parental Lock Category Select> screen in step 3.

- A confirmation message appears. Touch [Yes].

■ Skipping unwanted channels

If you do not want to receive some channels, you can skip them.

1 Display the <Skip Category Select> screen.

On the source control screen, touch as follows:



Then, on the <SiriusXM SETUP> screen, touch [Skip Channel Select].

2 Select a category.

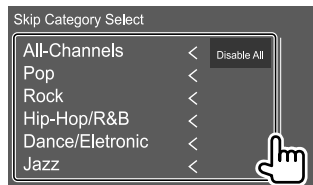

3 Select [ON] for channels you want to skip.

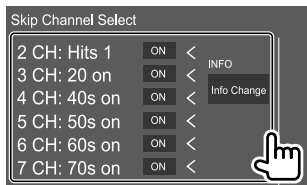

- Select [OFF] for the channels you do not want to skip.
- To switch the information on the list (channel name/artist name/song title/category name/content information), touch [Info Change].

4 Repeat steps 2 and 3 to skip multiple channels.

To clear the channel skipping for all skipped channels: Touch [Disable All] in the <Skip Category Select> screen in step 2.

- A confirmation message appears. Touch [Yes].

Resetting the SiriusXM® Satellite Radio settings

You can reset all the SiriusXM® settings you made and restore the initial settings.

1 Display the <SiriusXM SETUP> screen.

On the source control screen, touch as follows:



2 Reset the setting.

On the <SiriusXM SETUP> screen, touch [SiriusXM Reset].

- A confirmation message appears. Touch [Yes].

You can stream Pandora from iPhone/iPod touch or Android devices.

- Pandora is only available in certain countries. For more information, visit <www.pandora.com/legal>.
- Because Pandora is a third-party service, the specifications are subject to change without prior notice. Accordingly, compatibility may be impaired or some or all of the services may become unavailable.
- Some functions of Pandora cannot be operated from this unit.
- For issues using the application, contact Pandora at <pandora-support@pandora.com>.

Preparation

■ Installing the application

Your smartphone must have built-in Bluetooth and the following profiles must be supported:

- SPP (Serial Port Profile)
- A2DP (Advanced Audio Distribution Profile)

Establish an Internet connection using LTE, 3G, EDGE, or Wi-Fi.

Ensure you are logged in to your smartphone application. If you do not have a Pandora account, you can create one for free from your smartphone or at <www.pandora.com>.

Install the latest version of the Pandora application on your smartphone.

- For Android devices: Search for "Pandora" in Google Play to find and install the most recent version.
- For iPhone/iPod touch: Search for "Pandora" in the Apple iTunes App Store to find and install the most recent version.

■ Connecting the device

For Android devices

Pair the Android device with this unit via Bluetooth. (Page 40)

For iPhone/iPod touch

- Via USB input terminal: Connect iPhone/iPod touch with the cable KCA-iP103 (optional accessory). (Page 17)
- Via Bluetooth: Pair the iPhone/iPod touch with this unit. (Page 40)

Playback operations

■ Playback information and key operation

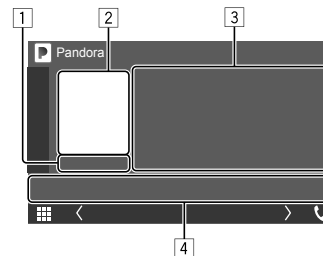

E.g. Pandora source control screen for DDX795

You can also operate Pandora with optional remote controller, KNA-RCDV331.

You can only control play, pause and skip with the remote controller.









- 1 Playing time
- 2 Picture data
- 3 Track information
 - Touching [◀] scrolls the text if not all of the text is shown.
- 4 Operation keys*

* See "Operation keys on source control screen" on page 34.

Operation keys on source control screen

- The appearance of the operation keys may differ, however the similar operation keys have the same operations.
- See also “Common operation keys on source control screen” on page 11.

Touching the operation keys performs the following actions:

	
	Displays the <Station List> screen.
	Thumbs down to the current track and skips to the next track. <ul style="list-style-type: none"> • The track is not skipped if the Pandora skip reaches its limit.
	Registers the current track as a favorite.
	Starts (▶)/pauses (⏸) playback.
	Skips the current track. <ul style="list-style-type: none"> • Not available when the Pandora skip reaches its limit.
	Bookmarks the current track.
	Creates a new station.

Selecting a station from the list

1 Display the <Station List> screen.

On the source control screen, touch as follows:



2 Select a station from the list.

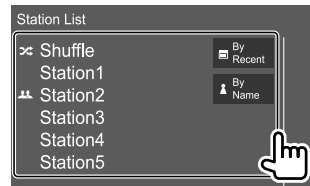

- To play all the songs in the registered stations randomly, touch **[Shuffle]**.
- To sort the list in reverse chronological order, touch **[By Recent]**.
- To sort the list in alphabetical order, touch **[By Name]**.
- The  indicator appears on the left of the item when the station is shared.

Create a new station

1 Display the station creating window.

On the source control screen, touch as follows:



2 Select a method to create a station.

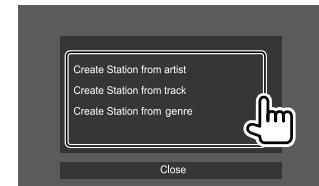

[Create Station from artist]	Creates a new station based on an artist currently played.
[Create Station from track]	Creates a new station based on a song currently played.
[Create Station from genre]	Displays the <Genre List> screen. Select a genre to create a new station.

To close the window: Touch **[Close]**.

Spotify

With Spotify, your music is everywhere. Working out, partying or relaxing, the right music is always at your fingertips. There are millions of songs on Spotify—from old favorites to the latest hits. Just choose the music you love, or let Spotify surprise you.

You can stream Spotify from iPhone/iPod touch or Android devices.

- Because Spotify is a third-party service, the specifications are subject to change without prior notice. Accordingly, compatibility may be impaired or some or all of the services may become unavailable.
- Some functions of Spotify cannot be operated from this unit.
- For issues using the application, contact Spotify at <www.spotify.com>.

Preparation

■ Installing the application

Your smartphone must have built-in Bluetooth and the following profiles must be supported:

- SPP (Serial Port Profile)
- A2DP (Advanced Audio Distribution Profile)

Establish an Internet connection using LTE, 3G, EDGE, or Wi-Fi.

Ensure you are logged in to your smartphone application. If you do not have a Spotify account, you can create one for free from your smartphone or at <www.spotify.com>.

Install the latest version of the Spotify application on your smartphone.

- For Android devices: Search for “Spotify” in Google Play to find and install the most recent version.
- For iPhone/iPod touch: Search for “Spotify” in the Apple iTunes App Store to find and install the most recent version.

■ Connecting the device

For Android devices

Pair the Android device with this unit via Bluetooth. (Page 40)

For iPhone/iPod touch

- Via USB input terminal: Connect iPhone/iPod touch with the cable KCA-iP103 (optional accessory). (Page 17)
- Via Bluetooth: Pair the iPhone/iPod touch with this unit. (Page 40)

Playback operations

■ Playback information and key operation

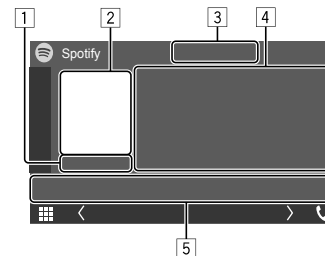

E.g. Spotify source control screen for DDX795

You can also operate Spotify with a remote controller, RC-DV340*1.

You can only control play, pause and skip with the remote controller.

- 1 Playing time
- 2 Picture data
- 3 Thumb up/down and repeat/shuffle playback mode keys*2
- 4 Track information
 - Touching [◀] scrolls the text if not all of the text is shown.
- 5 Operation keys*2

*1 For DDX795/DDX775BH/DDX595/DDX575BT: Purchase optional remote controller, KNA-RCDV331.

*2 See “Operation keys on source control screen” on page 36.

Operation keys on source control screen

- The appearance of the operation keys may differ, however the similar operation keys have the same operations.
- See also “Common operation keys on source control screen” on page 11.

Touching the operation keys performs the following actions:

[3]	
[👍]*1	Thumbs down to the current track and skips to the next track.
[👍]*1	Registers the current track as a favorite.
[🔀]*2 *3	Activates (🔀)/deactivates (🔀) shuffle playback mode.
[🔁]*2	Selects repeat playback mode (🔁: repeat one*3/🔁ALL: repeat all/🔁: repeat off).
[5]	
[☰]	Displays the Spotify menu screen.
[🎵]	Creates a new station (Start Radio).
[⏮]*2 *3 [⏭]	Selects a track.
[▶][⏸]	Starts (▶)/pauses (⏸) playback.
[+]	Saves the current track/artist/album to <Your Music> or <Your Library>.

*1 Not available for tracks in a playlist.

*2 Not available for tracks in the Radio.

*3 Available only for premium account users.

Creating your station (Start Radio)

Start Radio is to start a radio channel based on the currently played track.

Create your station.

On the source control screen, touch as follows:



Station is created and playback starts automatically.

- You can personalize your station using thumb up (👍) or thumb down (👎).
- Personalizing stations may not be available depending on the track.

Selecting a track

1 Display the Spotify menu screen.

On the source control screen, touch as follows:



2 Select the list type, then select a desired item.

- The list types displayed differ depending on the information sent from Spotify.

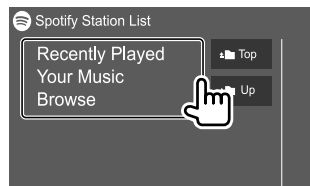

Other External Components

View camera

Install the view camera (separately purchased) in the appropriate position according to the instructions supplied with the view camera.

- For DDX795/DDX775BH/DDX595/DDX575BT/DDX718WBTL/DMX718WBTL: You can use both rear view camera and front view camera.
- For DDX6018BT/DMX6018BT/DDX5018BT: You can use rear view camera.

Connecting a view camera

See page 66 for more information for connection terminals.

- To use the rear view camera, a reverse lead (REVERSE) connection is required. (Pages 63 – 65)

Using the view camera

- For view camera settings, see “Camera settings” on page 53.

To display the rear view camera screen

The rear view camera screen is displayed by shifting the gear to the reverse (R) position when [R-CAM Interruption] is set to [ON] on the <Camera> screen. (Page 53)

- A caution message appears on the screen. To remove the caution message, touch the screen.

Other External Components

You can also display the picture from the rear view camera manually without shifting the gear to the reverse (R) position.

On the monitor panel:

DDX795
DDX775BH
DDX6018BT
DMX6018BT



DDX5018BT

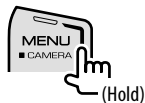

DDX595
DDX575BT



DDX718WBTL
DMX718WBTL

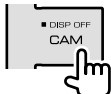

On the pop-up short-cut menu: Touch as follows (only for DDX795/DDX775BH/DDX6018BT/DDX5018BT/DDX595/DDX575BT/DDX718WBTL):



To display the front view camera screen

(Only for DDX795/DDX775BH/DDX595/DDX575BT/DDX718WBTL/DMX718WBTL)

- Set [**Front Camera**] to [**ON**] on the <Camera> screen beforehand. (Page 54)

While the rear camera screen is displayed, touch the area shown below.



- Each time you touch the area, the screen is switched between rear view camera and front view camera.

To exit the camera screen

Press **HOME** on the monitor panel or touch the area shown below.



AV-IN

(Only for DDX6018BT/DMX6018BT/DDX5018BT/DDX718WBTL/DMX718WBTL)

Connecting an external component

See page 66 for connection terminals.

Starting playback

1 Select "AV-IN" as the source.

On the Home screen, touch as follows:

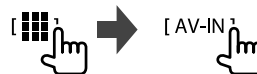

2 Turn on the connected component and start playing the source.

- For playback information, see "Source control screen" on page 10.

Other External Components

Watching TV

(Only for DDX6018BT/DMX6018BT/DDX5018BT/DDX718WBTL/DMX718WBTL)

Connecting a TV tuner box

Connect TV tuner box to the audio/video input (AV-IN) terminal and TV tuner remote control output (REMO OUT) terminal. (Page 66)

Displaying the TV screen

- Set [TV Tuner Control] to [ON] on the <AV> screen beforehand. (Page 50)

1 Select "TV" as the source.

On the Home screen, touch as follows:



2 Turn on the TV.

Playback information and key operation

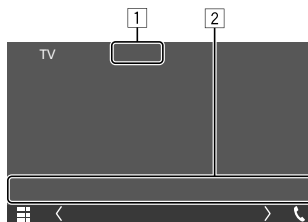

E.g. TV screen for DDX6018BT

- Hides the operation buttons on the screen while video is played.
- Operation keys*

* See the following "Operation keys on source control screen".

Operation keys on source control screen

- The appearance of the operation keys may differ, however the similar operation keys have the same operations.
- See also "Common operation keys on source control screen" on page 11.

Touching the operation keys performs the following actions:

- [CH▲]/[CH▼] Selects the channel.

Using the external navigation unit

(Only for DDX6018BT/DMX6018BT/DDX5018BT/DDX718WBTL/DMX718WBTL)

You can connect a navigation unit (KNA-G630: optional accessory) to the navigation input terminal so that you can view the navigation screen. (Page 66)

- The navigation guidance comes out of the front speakers even when you are listening to an audio source.

Viewing the navigation screen

- For navigation settings, see "Navigation settings" on page 55.

Select "NAV" as the source.

On the Home screen, touch as follows:



- While the navigation screen is displayed, the touch panel operations are available only for navigation.
- You can check navigation information on the secondary screen while listening to the other source. (Page 10)

Other External Components

To exit the navigation screen

DDX6018BT
DMX6018BT

DDX5018BT

DDX718WBTL
DMX718WBTL



Switching the screen between the navigation and current source

(Only for DMX6018BT/DMX718WBTL)

DMX6018BT

DMX718WBTL

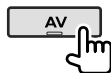

Using an external component via ADS adapter—OEM Features

(Only for DDX795/DDX775BH/DDX595/DDX575BT)

By connecting this unit to the bus system of the vehicle using iDataLink (commercially available), this unit can access the satellite radio source provided for the vehicle and vehicle information can be displayed on this unit.

- Displayable screens, button names, and screen names vary depending on the type of the connected iDataLink and the model of the vehicle.
- For details, visit <www.idatalink.com/>.

Connecting an ADS adapter

See page 66 for connection terminals.

Using an external component via an ADS adapter

- For settings to use an ADS adapter, see <OEM SETUP> on page 50.

1 Display the source/option selection screen.

On the Home screen, touch as follows:



2 Select an item.

- Displayable screens, button names, and screen names vary depending on the type of the connected iDataLink and the model of the car. For details, visit <www.idatalink.com/>.

[Satellite Radio]	Displays the control screen of the satellite radio source provided for the vehicle.
[Media Player]	Displays the control screen of the media player source provided for the vehicle.
[TEL]	Displays the control screen of the Bluetooth Hands Free function provided for the vehicle.

[BT Streaming]	Displays the control screen of the Bluetooth streaming function provided for the vehicle.
[Gauges]	Displays the information about the instruments such as a speedometer.
[Climate]*	Displays the information about the air conditioner of the vehicle.
[Parking Assist]	Displays the information about the Parking Distance Sensor of the vehicle.
[Vehicle Info]*	Displays the information about the tire pressures of the vehicle.
[Radar Detector]*	Displays the information about the Radar Detector.

* These ADS adapter features are displayed as the widget on the Home screen. You can display these screens by touching the widget.

Information

Bluetooth is a short-range wireless radio communication technology for mobile devices such as mobile phones, portable PCs and other devices. Bluetooth devices can be connected without cables and communicate with each other.

Note

- While driving, do not perform complicated operations such as dialing numbers, using the phonebook, etc. When you perform these operations, stop your car in a safe place.
- Some Bluetooth devices may not connect to this unit depending on the Bluetooth version of the device.
- This unit may not work for some Bluetooth devices.
- Connecting conditions may vary depending on your environment.
- For some Bluetooth devices, the device is disconnected when the unit is turned off.
- If your mobile phone supports PBAP (Phone Book Access Profile), you can display the following items on the touch panel when the mobile phone is connected.
 - Phonebook: up to 1 000 entries
 - Dialed calls, received calls, and missed calls (up to 50 entries in total)

Preparation

- Connect and install the microphone beforehand. For details, see pages 63 – 65.
- Set **[Bluetooth]** to **[ON]** on the **<Bluetooth>** screen. (Page 55)

Connection

When you connect a Bluetooth device to the unit for the first time:

- ① Register the device by pairing the unit and the device.
- ② Connect the device to the unit. (Page 41)

■ Registering a new Bluetooth device

Pairing allows Bluetooth devices to communicate with each other.

- The pairing method differs depending on the Bluetooth version of the device.
 - For devices with Bluetooth 2.1:
You can pair the device and the unit using SSP (Secure Simple Pairing) which only requires confirmation.
 - For devices with Bluetooth 2.0:
You need to enter a PIN code both on the device and the unit for pairing.
- Once connection is established, it is registered in the unit even if you reset the unit. Up to 10 devices can be registered in total.
- Two Bluetooth devices for Bluetooth phone and one for Bluetooth audio can be connected at a time.
- To use the Bluetooth function, you need to turn on the Bluetooth function of the device.

Auto pairing

When **<Auto Pairing>** is set to **[ON]** on the **<TEL SETUP>** screen, iOS (such as iPhone) devices are automatically paired when connected via USB. (Page 46)

Registering a Bluetooth device

- 1 Search for the unit (“DDX****” or “DMX****”) from your Bluetooth device and operate the device to register.

For a Bluetooth device compatible with SSP (Bluetooth 2.1):

Confirm the request both on the device and the unit.

On the device:

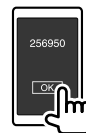

On the unit:

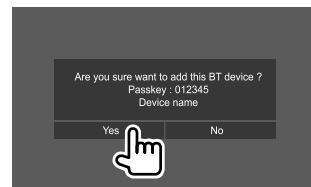

- Touch **[No]** to reject the request.

For a Bluetooth device compatible with Bluetooth 2.0:

Select the unit ("DDX****" or "DMX****") on your Bluetooth device.

- If a PIN code is required, enter the PIN code shown on the screen (initial: "0000").
To change PIN code, see page 42.

2 Determine usage as a hands free device (1), then touch [Close] (2).

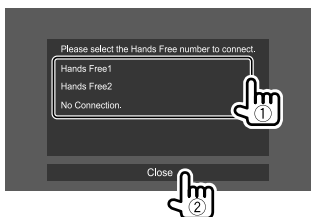

**[Hands Free1]/
[Hands Free2]** Select hands free number to use as the hands free device.

[No Connection.] Select this when you do not want to use as the hands free device.

3 When your Bluetooth device is compatible with A2DP or SPP: Determine usage as an audio player or a device with Apps installed.

[Yes] Select to use the device as an audio player.

[No] Select this when you do not want to use the Bluetooth device as an audio player.

4 When your Bluetooth device is compatible with PBAP: Select whether to transfer the phonebook of your Bluetooth device to the unit or not.

[Yes] Select to transfer the phonebook from your Bluetooth device.

[No] Select this when you do not want to transfer the phonebook.

■ Connecting/disconnecting a registered Bluetooth device

1 Display the <Select Device> screen.

On the Home screen, touch as follows:



Then, on the <SETUP> screen, touch **[Bluetooth]**.

On the <Bluetooth Setup> screen, touch **[Select Device]**.

2 Select the device you want to connect/disconnect.

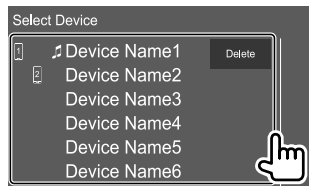

The icons beside the registered device indicate the following:

- : Connected as a mobile phone.
- : Connected as an audio player.

3 Select the usage of the device (1), then touch [Close] (2).

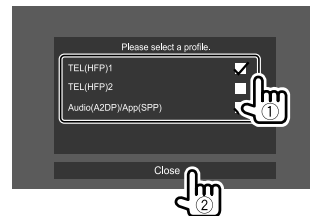

Each time you touch the selection, the usage is selected ("✓" appears) or deselected ("✓" disappears). Select to connect and deselect to disconnect the device.

**[TEL (HFP)1]/
[TEL (HFP)2]** Select to use as the hands free device.

**[Audio (A2DP)/
App (SPP)]** Select to use as the audio player or device with Apps installed.

To delete the registered Bluetooth device: Touch **[Delete]** in step 2, select devices to delete, then touch **[Delete]**. A confirmation message appears. Touch **[Yes]**.

- To select all devices, touch **All**.
- To deselect all selected devices, touch **All**.

■ Changing the PIN code

1 Display the <Change PIN Code> screen.

On the Home screen, touch as follows:



Then, on the <SETUP> screen, touch [Bluetooth].

On the <Bluetooth Setup> screen, touch [PIN Code].

2 Enter the PIN code (①), then confirm the entry (②).

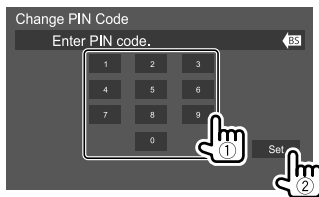

- To clear the last entry, touch [BS].

■ Changing the device name of the unit displayed on the paired device

1 Display the <Change Device Name> screen.

On the Home screen, touch as follows:



Then, on the <SETUP> screen, touch [Bluetooth].

On the <Bluetooth Setup> screen, touch [Device Name].

2 Enter the device name (①), then confirm the entry (②).



- To clear the last entry, touch [BS].
- To move the entry position, touch [◀/▶].

Bluetooth mobile phone

■ When a call comes in...

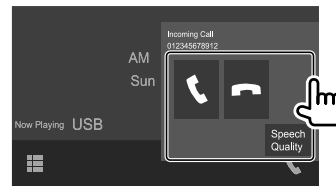

Touching the operation keys performs the following actions:

[☎]	Answers a call.
[📞]	Rejects a call.
[Speech Quality]	Displays the <Speech Quality adjust> screen. <ul style="list-style-type: none"> • Microphone Level: Adjusts the microphone volume level. (-10 to 10, initial: 0) • Echo Cancel Level: Adjusts the echo volume level. (OFF, -5 to 5, Initial: 0) • Noise Reduction Level: Adjusts the noise reduction volume. (OFF, -5 to 5, Initial: 0)

- Call information is displayed if acquired.
- Phone operation is not available while the picture from the view camera is displayed.

■ During a call...

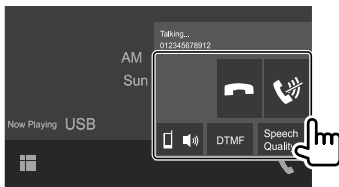

Touching the operation keys performs the following actions:

[📞]	Ends a call.
[🔇]	Mutes the volume of the microphone.
[📞/🔊]	Switches between hands free mode and phone mode.
[DTMF]	Enters DTMF (Dual Tone Multi Frequency), then sends text using the keypad.
[Speech Quality]	Displays the <Speech Quality adjust> screen. • See page 42 for details.

■ Making a call

1 Display the phone control screen.

On the Home screen, touch as follows:



2 Select a method to make a call.

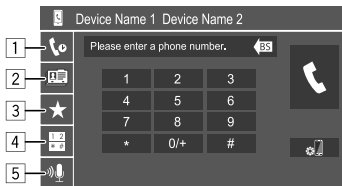

- 1 From the call history* (missed calls/received calls/dialed calls)
- 2 From the phonebook*
- 3 From the preset list (Page 44)
- 4 Use direct number entry
- 5 Use voice dialing

3 Select a contact to make a call.

Ⓐ When item 1, 2 or 3 is selected in step 2:

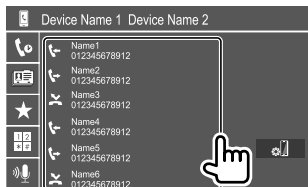

- If the selected contact has several phone numbers, the phone number list is displayed. Select a phone number to make a call.

To use alphabet search in the phonebook

- ① Touch [Q A-Z].
 - ② Touch the first letter you want to search for on the keypad.
To search for a number, touch [1].
 - ③ Select a contact you want to call from the list.
- You can select a first name or last name to use when sorting the list in alphabetical order on the <TEL SETUP> screen. (Page 46)

Ⓑ When item 4 is selected in step 2:

Enter the phone number (①), then make a call (②).

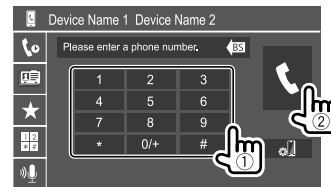

- To enter "+", touch and hold [0/+].
- To clear the last entry, touch [BS].

* Applicable only for mobile phone compatible with PBAP (Phone Book Access Profile).

© When item 5 is selected in step 2:

Say the name of the person you want to call.

- You can also make voice dialing by pressing and holding the **VOICE** on the monitor panel.
- Available only when the connected mobile phone has a voice recognition system.
- If the unit cannot find the target, "Press [Restart] to restart the voice recognition process." appears. Touch **[Restart]**, then say the name again.
- To cancel voice dialing, touch **[Stop]**.

■ Switching between two connected devices

You can change the device to use when two devices are connected.

On the phone control screen:

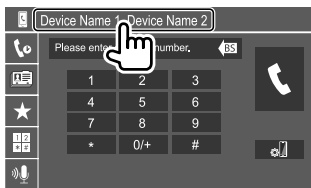

The active device is highlighted.

■ Presetting phone numbers

You can preset up to eight phone numbers.

1 Display the <Edit Preset Dial> screen.

On the Home screen, touch as follows:



Then, on the phone control screen, touch as follows:

[★] → [Edit]

2 Select a position to store into.



3 Select a method to add a phone number to preset list and register the number to the preset list (1), then touch [Close] (2).

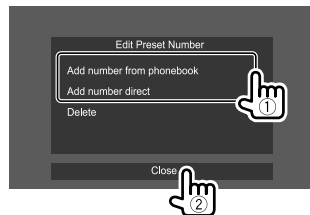

[Add number from phonebook]	Select a phone number from the phonebook.
[Add number direct]	Enter a phone number on the direct number entry screen, then touch [Set] to add to the preset list.

- To display the preset list, touch [★] on the phone control screen.

To delete a phone number from the preset list:
Select the phone number to delete on the <Edit Preset Dial> screen, then touch **[Delete]** in step 3.

To delete all phone numbers from the preset list:
Touch **[Delete all]** on the <Edit Preset Dial> screen in step 2.

■ Editing phonebook

To transfer the phonebook

If the connected Bluetooth mobile phone is compatible with Phone Book Access Profile (PBAP), you can transfer the phonebook of the mobile phone to the unit.

1 Display the phone control screen.

On the Home screen, touch as follows:



2 Start phonebook data transmission.

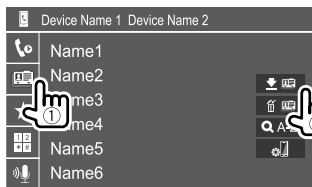

To delete contact from the phonebook: Touch [🗑️] in step 2 (2), select devices to delete, then touch [Delete]. A confirmation message appears. Touch [Yes].

- To select all devices, touch [☑️ All].
- To deselect all selected devices, touch [☐ All].
- Touch [Q A-Z] to search the contact by initial.

Bluetooth audio player

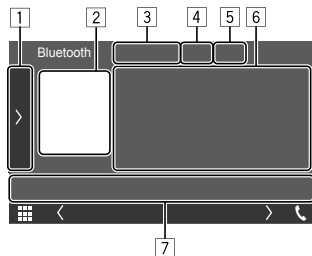

E.g. Bluetooth source control screen for DDX795

- 1 Displays/hides other available operation keys*1
- 2 Artwork (Shown if the track contains artwork)
- 3 Connected device name
- 4 Repeat/random playback mode keys*1
- 5 Signal strength and battery level (Appears only when the information is acquired from the device.)
- 6 Tag data*2 (current track title/artist name/album title)
 - Pressing [←] scrolls the text if not all of the text is shown.
- 7 Operation keys*1

*1 See “Common operation keys on source control screen” on page 11.

*2 Available only for devices compatible with AVRCP 1.3.

■ Playback information and key operation

- For playback information, see “Source control screen” on page 10.
- For key operations on the touch panel, see “Common operation keys on source control screen” on page 11.

Additional keys operations: Touching the operation keys performs the following actions.

[BT DEVICE CHANGE] Switches to another Bluetooth audio player.

■ Selecting a track from the list

1 Display the music list.

On the source control screen, touch as follows:



2 Select the folder, then the item in the selected folder.

- For details about the list operation, see page 12.

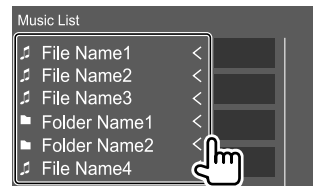

Bluetooth mobile phone settings

You can change various settings for using Bluetooth mobile phones on the <TEL SETUP> screen.

1 Display the <TEL SETUP> screen.

On the Home screen, touch as follows:



Then, on the <SETUP> screen, touch [**Bluetooth**].

On the <Bluetooth Setup> screen, touch [TEL SETUP].

2 Make the settings.



<Bluetooth HF/Audio>

Select the speakers used for Bluetooth mobile phones.

- **Front:** Front speakers only.
- **All (Initial):** All speakers.

<Auto Response>

- **1 – 30** (in 5 second steps): The unit answers the incoming calls automatically. Set the calling ring time (seconds).
- **OFF (Initial):** The unit does not answer the calls automatically. Answer the calls manually.

<Auto Pairing>

- **ON (Initial):** Establishes pairing automatically with the iOS device (such as iPhone) connected via USB. (Auto pairing may not work for some devices depending on the iOS version.)
- **OFF:** Cancels.

<Sort Order>

Select a first name or last name to use when sorting the list in alphabetical order.

- **First:** Sorts the list in the order of first name.
- **Last (Initial):** Sorts the list in the order of last name.

Settings

Audio settings

1 Display the <Audio> screen.

On the Home screen, touch as follows:

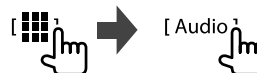

2 Select a setting to change.

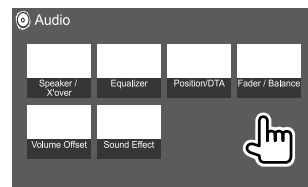

E.g. Audio settings screen for DDX795

You cannot change the <Audio> screen in the following situations:

- When the AV source is turned off.
- When the Bluetooth phone is used (making or receiving a call, during a call, or while voice dialing).
- During navigation guidance*

* Only for DDX6018BT/DMX6018BT/DDX5018BT/DDX718WBTL/DMX718WBTL.

Settings

<Speaker/X'over>

■ Setting the speakers and crossover frequency

- 1 Select a car type (①), select a speaker (②) (front speakers, rear speakers, or subwoofer) to set, then location and speaker/tweeter size (③) of the selected speaker.

A selection window appears for each setting. Select an item, then touch [Close] to close the window.

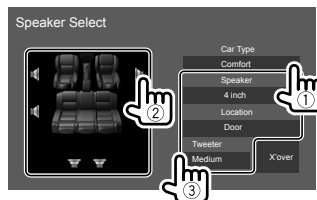

- Repeat steps ② and ③ to set all speakers.
- Adjustable items vary depending on the selected speaker type.
- When a speaker is not connected, select [None].
- When setting the front speakers, also select the speaker size for <Tweeter>.

- 2 Touch [X'over] to display the <X'over> screen.

- 3 Select the speaker type (①), then adjust the crossover frequency (②) of the selected speaker.

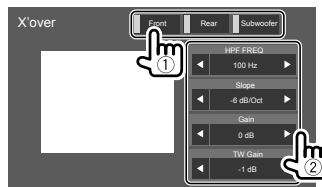

- Adjustable items vary depending on the selected speaker type/speaker size/crossover settings.

<HPF FREQ>

Adjusts the crossover frequency for the front or rear speakers (high pass filter).

<LPF FREQ>

Adjusts the crossover frequency for the speaker (low pass filter).

<Slope>

Adjusts the crossover slope.

<Gain>

Adjusts the output volume of the selected speaker.

<TW Gain>

Adjusts the output volume of the tweeter.

<Phase Inversion>

Selects the phase for the speaker.

<Equalizer>

The following adjustments are memorized for each source until you adjust the sound again. If the source is a disc, the adjustments are stored for each of the following categories.

- DVD/VCD
- CD
- Audio/video files (Page 66)

You cannot adjust the sound when the unit is in standby.

■ Selecting a preset sound mode

- 1 Display the preset sound modes.

[Preset Select]

- 2 Select a preset sound mode.

- Pops/Easy/Top40/Jazz/Powerful/Rock/Flat (Initial)/iPod/User1/User2/User3/User4

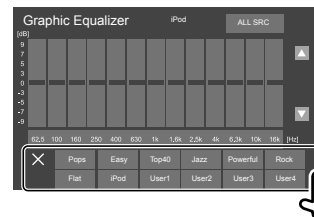

To hide the preset sound modes: Touch [X].

■ Store your own sound adjustments

- 1 Select a preset sound mode.
- 2 Select a band (①) and adjust the level (②), then adjust the sound (③).

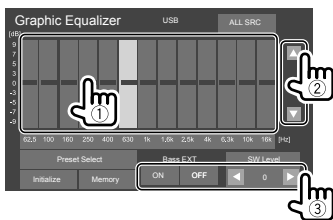

Adjust the sound as follows:

<Bass EXT>

Activates/deactivates bass.

- ON/OFF (Initial)

<SW LEVEL>

Adjusts the subwoofer level.*

- -50 to +10 (Initial: 0)

- 3 Repeat step 2 to adjust the level of other bands.

- 4 Touch [Memory] to store adjustment.

A user selection window appears. Select from [User1] to [User4] to store your adjustment, then touch [Close] to close the window.

- To apply the adjusted equalizer to all playback source, touch [ALL SRC], then touch [OK] to confirm.
- To clear the adjustment, touch [Initialize].

* Not adjustable when <None> is selected for subwoofer on the <Speaker Select> screen. (Page 47)

<Position/DTA>

You can adjust the sound effects according to your listening position. You can also localize the sound image in front of the selected seat.

■ Setting the listening position

Touch [Listening Position] (①), then select the listening position ([Front L], [Front R], [Front All], or [All]) (②).

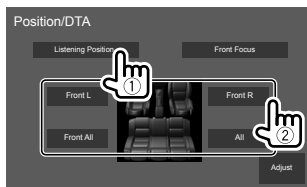

■ Adjusting the Digital Time Alignment (DTA)

Make fine adjustments to the delay time of the speaker output to create a more suitable environment for your car.

- 1 Touch [Adjust] on the <Position/DTA> screen to display the DTA adjustment screen.

- 2 Touch [Delay] (①), then adjust the Digital Time Alignment (DTA) value (②) for each speaker.

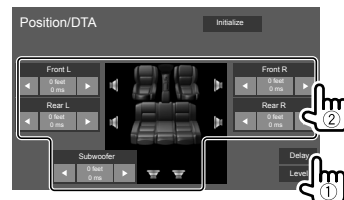

- To determine the adjustment value, see “Determining the value for <Position/DTA> adjustment” on page 49.

- 3 Touch [Level] (①), then adjust the output volume (②) for each speaker.

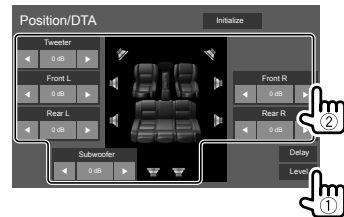

To initialize the setting value: Touch [Initialize].

Localizing the sound image—Front Focus

- 1 Touch **[Front Focus]** (1), select the listening position (2) to set as the front position, then touch **[Adjust]** (3).

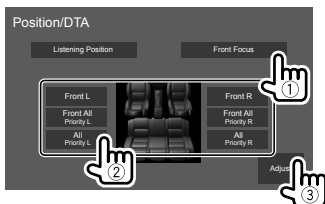

- When you are sitting on the **[Front All]** (front seats) or **[All]** (front and rear seats) position, select left (“Priority L”) or right (“Priority R”) to specify the position to localize the sound image.

- 2 Touch **[Delay]** (1), then adjust the sound image (2) precisely.



[Sound Image LR (Front)]

Adjusts the sound image to be localized set on the front position.

[Sound Image LR (Rear)]

Adjusts the sound image to be localized set on the rear position.

[Size of the Virtual Sound Field]

Adjusts the virtual sound field to the desired field size.

- If the sound image moves out of the front position, adjust **[Sound Image LR (Front)]**/**[Sound Image LR (Rear)]**.

[Subwoofer Delay]

Adjusts the delay time of the subwoofer sound.

- 3 Touch **[Level]** (1), then adjust the output volume (2) for each speaker.

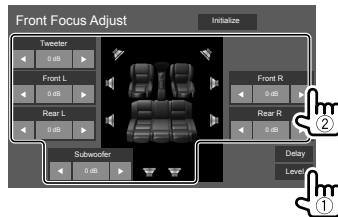

To initialize the setting value: Touch **[Initialize]**.

Determining the value for <Position/DTA> adjustment

If you specify the distance from the center of the currently set listening position to every speaker, the delay time will be automatically computed and set.

- 1 Determine the center of the currently set listening position as the reference point.
- 2 Measure the distances from the reference point to the speakers.
- 3 Calculate the differences between the distance of the furthest speaker and other speakers.
- 4 Set the DTA value calculated in step 3 for individual speakers.
- 5 Adjust gain for individual speakers.

E.g. When **[Front All]** is selected as the listening position

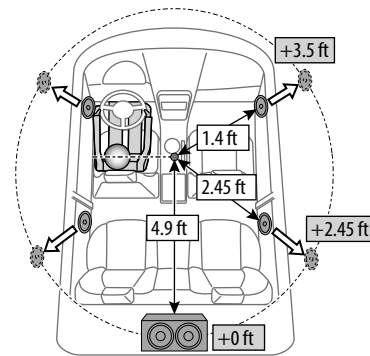

Settings

<Fader/Balance>

Touch [▲]/[▼]/[◀]/[▶] or drag the  mark to adjust.

<Fader>

Adjusts the front and rear speaker output balance.

When using a two-speaker system, set the fader to the center (0).

- **F15 to R15** (Initial: 0)

<Balance>

Adjusts the left and right speaker output balance.

- **L15 to R15** (Initial: 0)

To clear the adjustment: Touch [Center].

<Volume Offset>

Adjust and store the auto-adjustment volume level for each source. The volume level will automatically increase or decrease when you change the source.

If you have increased the volume first, then reduced the volume using the Volume Offset, the sound generated if you suddenly switch to another source may be extremely loud.

- **-5 to +5** (Initial: 0)

To initialize the setting value: Touch [Initialize].

<Sound Effect>

Adjust the sound effect.

<Bass Boost>

Selects the bass boost level.

- **OFF** (Initial)/1/2/3

<Loudness>

Adjusts loudness. (The LOUD indicator lights up when the loudness is adjusted.)

- **OFF** (Initial)/Low/High

<Drive Equalizer>

Reduces the driving noise by raising the bandwidth.

- **OFF** (Initial)/ON

<Space Enhancer>*

Virtually enhances the sound space using the Digital Signal Processor (DSP) system. Select the enhance level.

- **OFF** (Initial)/Small/Medium/Large

<Supreme>

Restores the sound lost due to audio compression to a realistic sound.

- **OFF/ON** (Initial)

<Realizer>

Virtually makes the sound more realistic using the Digital Signal Processor (DSP) system. Select the sound level.

- **OFF** (Initial)/1/2/3

<Stage EQ>

Moves the localization of the sound image to the lower or higher point. Select the height.

- **OFF** (Initial)/Low/Middle/High

* You cannot change the setting when "HD Radio" or "Radio" is selected as the source.

AV settings

Display the <AV> screen.

On the Home screen, touch as follows:



Then, on the <SETUP> screen, touch [AV].

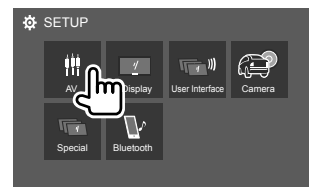

E.g. Setup screen for DDX795

<TV Tuner Control>

(Only for DDX6018BT/DMX6018BT/DDX5018BT/DDX718WBTL/DMX718WBTL)

- **ON:** Enables control of TV operation on "AV-IN".
- **OFF** (Initial): Select this to use "AV-IN" with components other than TV Tuner.

<OEM SETUP>*

(Only for DDX795/DDX775BH/DDX595/DDX575BT)
Confirm the information or change the settings for using the ADS adapter.

* Appears only when an ADS adapter is connected to the iDataLink input terminal. (Page 66)

Settings

Display settings

Display the <Display> screen.

On the Home screen, touch as follows:



Then, on the <SETUP> screen, touch [Display].

<Dimmer>

- **ON:** Activates dimmer.
- **OFF:** Deactivates dimmer.
- **SYNC** (Initial): Dims the screen and button illumination when you turn on the headlights.
 - The ILLUMI lead connection is required. (Page 63)*1
- **NAV-SYNC***2: Activates or deactivates dimmer according to the day/night display setting of the external navigation unit.

<OSD Clock>

- **ON** (Initial): Displays the clock while a video source is playing.
- **OFF:** Cancels.

*1 Only for DDX795/DDX775BH/DDX6018BT/DMX6018BT/DDX5018BT/DDX595/DDX575BT.

*2 Only for DDX6018BT/DMX6018BT/DDX5018BT/DDX718WBTL/DMX718WBTL.

<Key Color>

You can change the illumination color of the buttons on the monitor panel.

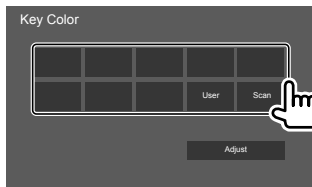

- You can also adjust the illumination color yourself. Touch [Adjust] to display the illumination color adjustment screen, then adjust the color. The adjustment is saved in [User].
- Selecting [Scan] changes the illumination color gradually.

<Background>

You can change the background design or color.

To change the background design:

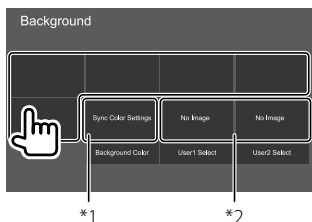

To change the background color: Touch [Background Color], then select the color on the <Background Color> screen.

- You can select same color selected in <Key Color> as the background color by touching [Sync Color Settings].
- If [Scan] is selected in <Key Color>, user cannot select [Sync Color Settings].

*1 Selects background color in advance.

*2 Selects a loaded favorite image in advance.

Storing your favorite image for the background

You can use your favorite image stored on the connected USB device for the background.

- Connect the USB device on which the image is stored beforehand.
- Use a JPEG/PNG/BMP file with a resolution of 800 x 480 pixels.

- 1 Touch [User1 Select] or [User2 Select] to store the image for the <Background> screen.
- 2 Select the folder, then the file for the background image in the selected folder.

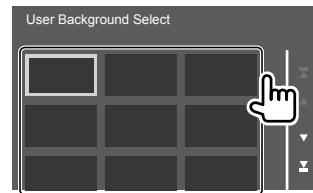

- 3 Rotate the image (①) if necessary, then confirm the selection (②).

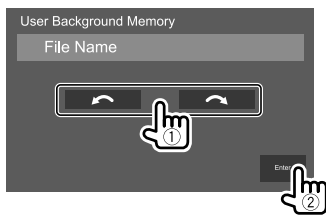

A confirmation message appears. Touch **[Enter]** to store the new image. (The existing image is replaced with the new one.)

<Viewing Angle>

Select the viewing angle in relation to the monitor to make the image on the screen easier to see.

- 0 (Initial)/-1/-2/-3

User interface settings

Display the <User Interface> screen.

On the Home screen, touch as follows:



Then, on the <SETUP> screen, touch **[User Interface]**.

<Steering Remote Controller>

(Only for DDX6018BT/DMX6018BT/DDX5018BT/DDX718WBTL/DMX718WBTL)

Assign functions to the keys on the remote controller of the steering wheel.

- This function is available only when your car is equipped with the electrical steering remote controller.
- You can only register/change the functions while you are parked.
- If your steering remote controller is not compatible, learning may not be completed and an error message may appear.

- 1 When the unit is ready for learning, press and hold a steering remote controller button for about 2 seconds to register/change.

- Refer to the message displayed to confirm whether the unit is ready before proceeding.

- 2 Select a function to assign to the selected button.

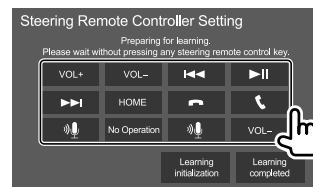

- 3 Repeat steps 1 and 2 to register other functions to other buttons.

- 4 Touch **[Learning completed]** to finish procedure.

A confirmation message appears. Touch **[Yes]**.

- The unit can register/change all of the buttons' functions at the same time. To do this, press all buttons in turn and after pressing all of them, touch **[Learning completed]** in step 2. However, new functions cannot be learned after this operation.
- When changing the functions already learned, touch the assigned function you want to change in step 2 and then touch to select the new function from the function list.
- Confirm the contents of the settable functions in the function list. You cannot edit the function list.

To initialize the setting: Touch **[Learning initialization]** in step 2.

- A confirmation message appears. Touch **[Yes]**.
– To cancel the initialization, touch **[No]**.

Settings

<Beep>

- **ON** (Initial): Activates the key-touch tone.
- **OFF**: Deactivates the key-touch tone.

<Parking Assist Display>

(Only for DDX795/DDX775BH/DDX595/DDX575BT)

When an ADS adapter is connected, you can display information about obstacles around the car.

- **ON**: Always displays information while the parking guidelines are displayed.
- **Dyn.** (Initial): Displays information when the sensor detects obstacles.
- **OFF**: Cancels.

<Parking Assist Position>

(Only for DDX795/DDX775BH/DDX595/DDX575BT)

Select where information about obstacles is displayed on the screen.

- **Left/Right** (Initial)

<Language Select>

Select the text language used for on-screen information. For details, see "Initial settings" on page 7.

<Touch Panel Adjust>

Adjust the touch positions of the buttons on the screen.

Touch and hold the center of the marks at the lower left (①), then the upper right (②) as instructed.

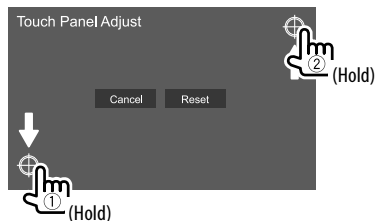

- To reset the touch position, touch **[Reset]**.
- To cancel the current operation, touch **[Cancel]**.

<Clock>

Select the method to set the date and clock. For details, see "Calendar/clock settings" on page 8.

<Time Zone>*

Select the time zone for your area. For details, see "Calendar/clock settings" on page 8.

<Clock Adjust>*

Adjust the date and clock manually. For details, see "Calendar/clock settings" on page 8.

* Available when **[Clock]** is set to **[Manual]**.

Camera settings

Display the <Camera> screen.

On the Home screen, touch as follows:



Then, on the **<SETUP>** screen, touch **[Camera]**.

<R-CAM Interruption>

- **ON**: Displays the picture from the rear view camera when you shift the gear to the reverse (R) position.
- **OFF** (Initial): Select this when no camera is connected.

<Parking Guidelines>

- **ON** (Initial): Displays the parking guidelines.
- **OFF**: Hides the parking guidelines.

Settings

<Guidelines Setup>

Adjust the parking guidelines according to the size of the car, parking space and so on.

When adjusting the parking guidelines, make sure to use the parking brake to prevent the car from moving.

Touch one of the  marks (①), then adjust the position of the selected  mark (②).

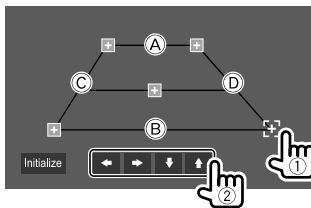

Make sure that (A) and (B) are horizontally parallel, and that (C) and (D) are the same length.

- Touch **[Initialize]** to set all the marks to the initial default position. A confirmation message appears. Touch **[Yes]**.

<Front Camera>

(Only for DDX795/DDX775BH/DDX595/DDX575BT/DDX718WBTL/DMX718WBTL)

- **ON**: Select this when a front view camera is connected.
- **OFF** (Initial): Select this when no camera is connected.

<Front Camera Mirror Image>

(Only for DDX795/DDX775BH/DDX595/DDX575BT/DDX718WBTL/DMX718WBTL)

- **ON**: Displays the picture from the front view camera horizontally reversed.
- **OFF** (Initial): Displays the picture from the front view camera as it is.

Special system settings

Display the <Special> screen.

On the Home screen, touch as follows:



Then, on the <SETUP> screen, touch **[Special]**.

<DEMO>

- **ON** (Initial): Activates the display demonstration.
- **OFF**: Deactivates the display demonstration.

<Manual Power OFF>

Assign the function of the **HOME** on the monitor panel when pressed and held.

- **AV OFF**: Turns off the screen and audio.
The screen and audio restores when receiving call, inputs video signal from the rear view camera, etc.
- **Complete OFF** (Initial): Turns off the power.

<SETUP Memory>

- **Lock**: Locks the <Audio SETUP Memory>/<Audio SETUP Recall>/<Audio SETUP Clear> settings.
 - The items in the <Speaker/X'over> settings cannot be adjusted when **[Lock]** is selected.
- **Unlock**: Unlocks the settings.

<Audio SETUP Memory>*

Memorizes the following audio settings:

- Fader/Balance
- Speaker/X'over
- Equalizer (Adjustment on user preset ([User1] – [User4])/Subwoofer level adjustment)
- Position/DTA
- Sound Effect

A confirmation message appears. Touch **[Yes]**.

<Audio SETUP Recall>*

Recall the settings memorized by <Audio SETUP Memory>. A confirmation message appears. Touch **[Yes]**.

<Audio SETUP Clear>*

Clear the settings made on the <Audio> screen. A confirmation message appears. Touch **[Yes]**.

<Software Information>

Display the information of the software (such as serial number, application version, system version, etc.). You can update the software.

* Available only when <SETUP Memory> is set to **[Unlock]**.

Settings

<Open Source Licenses>

Show the Open Source Licenses.

<Initialize>

Initialize all settings made on the unit. A confirmation message appears. Touch **[Yes]**.

- The settings memorized on the **<Audio SETUP Memory>** are not initialized.

Bluetooth settings

Display the <Bluetooth> screen.

On the Home screen, touch as follows:



Then, on the **<SETUP>** screen, touch **[Bluetooth]**.

<Bluetooth>

- **ON** (Initial): Activates the Bluetooth function of the unit.
- **OFF**: Deactivates the Bluetooth function of the unit.

<Select Device>

Connect or disconnect the paired device. (Page 41)

<Device Name>

Display/change the device name to be shown on the Bluetooth device. (Page 42)

<PIN Code>

Change the PIN code of the unit. (Page 42)

<Device Address>

Display the device address of the unit.

<TEL SETUP>

Configure the setting for using a Bluetooth mobile phone. (Page 46)

Security settings

(Only for DDX6018BT/DMX6018BT/DDX5018BT/DDX595/DDX575BT/DDX718WBTL/DMX718WBTL)

Display the <Security> screen.

On the Home screen, touch as follows:



Then, on the **<SETUP>** screen, touch **[Security]**.

<SI>

(Only for DDX5018BT/DDX595/DDX575BT)

Activate or deactivate the security function. (Page 8)

<Security Code Set>

(Only for DDX6018BT/DMX6018BT/DDX5018BT/DDX718WBTL/DMX718WBTL)

Register the security code for the unit. (Page 7)

<Security Code Cancellation>

(Only for DDX6018BT/DMX6018BT/DDX5018BT/DDX718WBTL/DMX718WBTL)

Clear the security code. (Page 7)

<Security Code Change>

(Only for DDX6018BT/DMX6018BT/DDX5018BT/DDX718WBTL/DMX718WBTL)

Change the security code. (Page 7)

Navigation settings

(Only for DDX6018BT/DMX6018BT/DDX5018BT/DDX718WBTL/DMX718WBTL)

Display the <Navigation> screen.

On the Home screen, touch as follows:



Then, on the **<SETUP>** screen, touch **[Navigation]**.

<NAV Voice Volume>

Adjust the volume of the navigation guidance. (**0** to **40**, Initial: **24**)

Remote Controller

- For DDX6018BT/DMX6018BT/DDX5018BT/DDX718WBTL/DMX718WBTL: This unit can be operated using the remote controller (RC-DV340) supplied with this unit.
- For DDX795/DDX775BH/DDX595/DDX575BT: Optional remote controller KNA-RCDV331 is designed for controlling this unit. Refer to the instruction manual that comes with the remote controller.

⚠ CAUTION

- Put the remote controller in a place where it will not move during braking or other operations. A dangerous situation could result if the remote controller falls down and gets wedged under the pedals while driving.
- Do not leave the battery near fire or under direct sunlight. A fire, explosion or excessive heat generation may result.
- Do not recharge, short, break up or heat the battery, or place it in an open fire. Such actions may cause the battery to leak fluid. If spilled fluid comes in contact with your eyes or clothing, immediately rinse with water and consult a physician.
- Place the battery out of reach of children. In the unlikely event that a child swallows the battery, immediately consult a physician.

Preparation

■ Battery installation

Use two "AAA"/"R03"-size batteries. Insert the batteries with the + and – poles aligned properly, following the illustration inside the case.

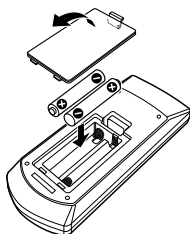

- Always insert batteries from – poles to avoid bending the springs.
- If the remote controller operates only over shorter distances or does not operate at all, it is possible that the batteries are depleted. In such instances, replace both batteries with new ones.

■ Remote controller mode switch

The functions operated from the remote controller differ depending on the position of the mode switch.

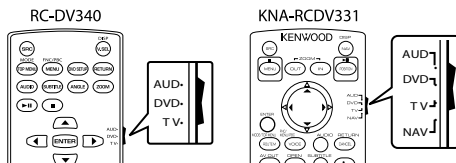

- **AUD mode:** Switch to this mode when controlling a selected source or tuner source, etc.
 - When controlling a player that is not integrated in the unit, select "AUD" mode.
- **DVD mode:** Switch to this mode when playing DVDs or CDs etc. with the player integrated in this unit.
- **TV mode:** Not used.
- **NAV mode:** Not used.
- The position of the remote control mode switch is indicated in the title of each mode, e.g., "AUD mode".

Basic operations for RC-DV340 (supplied)

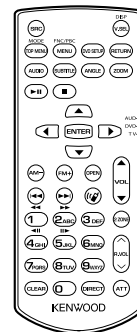

Remote Controller

■ Common operations (AUD mode)

SRC	<ul style="list-style-type: none">• Selects the source.• Hangs up the incoming/current call.
▲/▼ VOL	Adjusts the volume level.
ATT	Attenuates/restores the sound.
DISP/V.SEL	<ul style="list-style-type: none">• For DDX795/DDX775BH/DDX595 DDX575BT: Switches to the current source control screen.• For DDX6018BT/DMX6018BT/DDX5018BT/DDX718WBTL/DMX718WBTL: Switches to the navigation screen.
ENTER	Enters options.
(📞)	Answers incoming calls.
FNC/PBC/MENU	Switches the control screen.
MODE/TOP MENU	Changes the aspect ratio. <ul style="list-style-type: none">• The aspect ratio changes each time you press this key.
OPEN	Adjusts the panel angle. <ul style="list-style-type: none">• The panel angle changes each time you press this key.

■ DVD/VCD (DVD mode)*

▲/▼/◀/▶	Moves the cursor when displaying a menu.
◀◀/▶▶	Selects a track.

▶/ 	Starts/pauses playback.
■	Stops and memorizes the point where the disc stops.
0 - 9	<ul style="list-style-type: none">• Specifies the number to search for in direct search.• 1/2: Fast forwards/backwards.<ul style="list-style-type: none">– Fast forward/backward speed changes each time you press this key.• 4/5: Slow forwards/backwards during pause.
MODE/TOP MENU	Shows the disc top menu.
FNC/PBC/MENU	Shows the disc menu.
SUBTITLE	Changes the subtitle language.
ZOOM	Changes the zoom ratio. <ul style="list-style-type: none">• The zoom ratio changes each time you press this key.
ANGLE	Changes the picture angle. <ul style="list-style-type: none">• The picture angle changes each time you press this key.
AUDIO	Changes the voice language. <ul style="list-style-type: none">• The voice language changes each time you press this key.
DIRECT	Enters direct search mode.
CLEAR	Deletes a character while in direct search mode.

* Only for DDX6018BT/DDX5018BT/DDX718WBTL.

■ Music Disc/Audio file/Video file (AUD mode)

AM -/FM +	Selects a folder.
◀◀/▶▶	Selects a track/file.
▶/ 	Starts/pauses playback.
0 - 9	Specifies the number to search for in direct search.
DIRECT	Enters direct search mode.
■ Radio (AUD mode)	
AM -/FM +	Selects the band.
◀◀/▶▶	Searches for stations.*
▶/ 	Changes the seek mode (AUTO1, AUTO2, MANUAL).
0 - 9	Specifies the frequency of the station to receive to search for in direct search.
DIRECT	Enters direct search mode.

* The search method differs according to the selected seek mode.

Remote Controller

■ iPod/Android (AUD mode)

◀◀/▶▶ Selects music/videos.

▶/|| Starts/pauses playback.

■ USB (AUD mode)

AM -/FM + Selects a folder.

◀◀/▶▶ Selects a file.

▶/|| Starts/pauses playback.

■ Searching for an item directly

While listening to the radio or during disc playback, you can search for a station frequency/chapter/title/folder/file/track directly using the number buttons.

- To search for a track from the VCD menu, perform during PBC playback.

1 Press **DIRECT** to enter the search mode.

- Each time you press **DIRECT**, the item to search for changes.

2 Press a number button to select a desired item (station frequency/chapter/title/folder/file/track).

- To erase a misentry, press **CLEAR**.

3 Confirm the selection.

- For station frequency: Press ◀◀/▶▶.
- For others: Press **ENTER**.

To exit the search mode: Press **DIRECT**.

Basic operations for KNA-RCDV331 (optionally purchased)

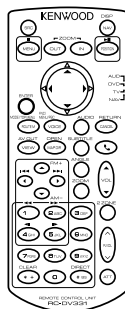

■ Common operations (AUD/DVD mode)

SRC*¹

- Selects the source.
- Hangs up the incoming/current call.

VOL ▲/▼ Adjusts the volume level.

ATT Attenuates/restores the sound.

VOICE/FNC/MENU/PBC*¹ For discs/USB/iPod: Switches to the current source control screen.

ENTER Enters options.

 Answers incoming calls.

ROUTE M/MODE/TOP MENU*¹ Changes the aspect ratio.

- The aspect ratio changes each time you press this key.

VIEW/AV OUT Switches the AV source to be output.

MAP DIR/OPEN Adjusts the panel angle.*²

- The panel angle changes each time you press this key.

NAV/DISP Switches to the current source control screen.

ZOOM OUT/IN Not used for this unit.

2 ZONE Not used for this unit.

R.VOL  Not used for this unit.

*¹ Available only when the AUD mode is selected.

*² Only for DDX795/DDX775BH.

■ DVD/VCD (DVD mode)

▲/▼/◀/▶ Moves the cursor when displaying a menu.

◀/|◀◀ / ▶▶/▶ Selects a track.

▲/FM+ / ▼/AM- Selects a folder.

POSITION/▶/|| Starts/pauses playback.

MENU/■ Stops and memorizes the point where the disc stops.

0 - 9

- Specifies the number to search for in direct search.
- **1/2**: Fast forwards/backwards.
- **4/5**: Slow forwards/backwards.
- Slow forward/backward speed changes each time you press this key. (For DVD only)

Remote Controller

* +/CLEAR	Deletes a character while in direct search mode.
# BS/DIRECT	Enters direct search mode.
ROUTE M/ MODE/ TOP MENU	Shows the disc top menu.
VOICE/FNC/ MENU/PBC	<ul style="list-style-type: none">• Shows the disc menu.• Turns the playback control on or off while playing VCD.
CANCEL/ RETURN	Displays previous screen.
AUDIO	<p>Changes the voice language.</p> <ul style="list-style-type: none">• The voice language changes each time you press this key.
SUBTITLE	Changes the subtitle language.
ANGLE	<p>Changes the picture angle.</p> <ul style="list-style-type: none">• The picture angle changes each time you press this key.
ZOOM	<p>Changes the zoom ratio.</p> <ul style="list-style-type: none">• The zoom ratio changes each time you press this key.

■ Music Disc/Audio file/Video file (AUD mode)

▲/FM+ / ▼/AM-	Selects a folder.
◀/◀◀ / ▶▶/▶	Selects a track/file.
POSITION/▶ 	Starts/pauses playback.
0 - 9	Specifies the number to search for in direct search.
# BS/DIRECT	Enters direct search mode.

■ HD Radio*1/Radio/SiriusXM (AUD mode)

▲/FM+ / ▼/AM-	Selects the band.
◀/◀◀ / ▶▶/▶	Searches for stations.*2
POSITION/▶ 	Changes the seek mode (AUTO1, AUTO2, MANUAL).
0 - 9	Specifies the frequency of the station to receive to search for in direct search.
# BS/DIRECT	Enters direct search mode.

*1 Only for DDX795/DDX775BH

*2 The search method differs according to the selected seek mode.

■ iPod (AUD mode)

◀/◀◀ / ▶▶/▶	Selects music/videos.
POSITION/▶ 	Starts/pauses playback.

■ USB (AUD mode)

▲/FM+ / ▼/AM-	Selects a folder.
◀/◀◀ / ▶▶/▶	Selects a file.
POSITION/▶ 	Starts/pauses playback.

■ Searching for an item directly

While listening to the radio or during disc playback, you can search for a station frequency/chapter/title/folder/file/track directly using the number buttons.

- To search for a track from the VCD menu, perform during PBC playback.

1 Press # BS/DIRECT to enter the search mode.

- Each time you press # BS/DIRECT, the item to search for changes.

2 Press a number button to select a desired item (station frequency/chapter/title/folder/file/track).

- To erase a misentry, press * +/CLEAR.

3 Confirm the selection.

- For station frequency: Press ◀/◀◀ / ▶▶/▶.
- For others: Press ENTER.

To exit the search mode: Press # BS/DIRECT.

KENWOOD Remote APP

KENWOOD Remote is an application that connects and controls compatible KENWOOD car receivers via Bluetooth® like a wireless remote control.

You can also operate this unit from a smartphone using KENWOOD Remote APP.

This application can display the source information of this unit on the smartphone's screen, and enables the user to make an audio setting using the graphic user interface of this application.

This application also works as a free standalone music player application, when your smartphone is not connected to this unit.

- For details, visit <www.kenwood.com/car/app/kenwood_remote/eng/>.

WARNINGS

- DO NOT connect the ignition wire (red) and the battery wire (yellow) to the car chassis (ground), you may cause a short circuit, that in turn may start a fire.
- DO NOT cut out the fuse from the ignition wire (red) and the battery wire (yellow). The power supply must be connected to the wires via the fuse.
- Always connect the ignition wire (red) and the battery wire (yellow) to the power source running through the fuse box.

CAUTIONS

- Install this unit in the console of your car.
- Do not touch the metal parts of this unit during and shortly after the use of the unit. Metal parts such as the heat sink and enclosure become hot.
- When parking at a low ceiling area, turn off the unit to store the antenna. As when the unit is installed in the car with the function of auto antenna; the radio antenna extends automatically when you turn on the unit with the antenna control wire (ANT. CONT) connected. (Pages 63 – 65)

Before installation

Precautions on installation and connection

- Mounting and wiring this product requires skills and experience. For best safety, leave the mounting and wiring work to professionals.
- Mount the unit so that the mounting angle is 30° or less.
- Make sure to ground the unit to a negative 12 V DC power supply.
- Do not install the unit in a location exposed to direct sunlight or excessive heat or humidity. Also avoid places with too much dust or the possibility of water splashing.
- Do not use your own screws. Use only the screws provided. If you use the wrong screws, you could damage the unit.
- After the unit is installed, check whether the brake lamps, blinkers, wipers, etc. on the car are working properly.
- Do not press hard on the panel surface when installing the unit to the car. Otherwise scratches, damage, or failure may result.
- If the power is not turned on ("Miswiring DC Offset Error", "Warning DC Offset Error" is displayed), the speaker wire may have a short circuit or have touched the chassis of the car and the protection function may have been activated. In this case, the speaker wire should be checked.
- Keep all cables away from heat dissipating metal parts.

Installation and Connection

- If your car's ignition does not have an ACC position, connect the ignition wires to a power source that can be turned on and off with the ignition key. If you connect the ignition wire to a power source with a constant voltage supply, such as with battery wires, the battery may be drained.
- Only for DDX795/DDX775BH/DDX6018BT/DDX718WBTL: If the console has a lid, make sure to install the unit so that the monitor panel will not hit the lid when closing and opening.
- If the fuse blows, first make sure the wires are not touching to cause a short circuit, then replace the old fuse with one with the same rating.
- Insulate unconnected wires with vinyl tape or other similar material. To prevent a short circuit, do not remove the caps and do not let the cable out at the ends of the unconnected wires or the terminals.
- Secure the wires with cable clamps and wrap vinyl tape around the wires that comes into contact with metal parts to protect the wires and to prevent short circuit.
- Connect the speaker wires correctly to the terminals to which they correspond. The unit may be damaged or fail to work if you share the ⊖ wires or ground them to any metal part in the car.
- When only two speakers are being connected to the system, connect both connectors either to the front output terminals or to the rear output terminals (do not mix front and rear). For example, if you connect the ⊕ connector of the left speaker to a front output terminal, do not connect the ⊖ connector to a rear output terminal.

■ Parts list for installation

Note: This parts list does not include all the package contents.

- 1 Wiring harness (× 1)
- 2 Extension parking cable, 2 m (× 1)
- 3 Round head screws, M5 × 8 mm (× 6)
- 4 Microphone, 3 m (× 1)

Only for DDX795/DDX775BH/DDX6018BT/
DMX6018BT/DDX5018BT/DDX595/DDX575BT

- 5 Flat head screws, M5 × 8 mm (× 6)

Only for DDX795/DDX6018BT/DMX6018BT/
DDX5018BT/DDX595

- 6 Trim plate (× 1)

Only for DDX795/DDX595

- 7 Mounting sleeve (× 1)
- 8 Extraction keys (× 2)

Only for DDX6018BT/DMX6018BT/DDX5018BT/
DDX718WBTL/DMX718WBTL

- 9 Steering wheel remote input cable (× 1)

Only for DDX718WBTL/DMX718WBTL

- 10 Antenna extension cable (× 1)

■ Installation procedure

- 1 **Remove the key from the ignition and disconnect the ⊖ battery.**
- 2 **Make the proper input and output wire connections for each unit.**
- 3 **Connect the speaker wires of the wiring harness.**
- 4 **Connect the wires of the wiring harness in the following order: ground, battery, ignition.**
- 5 **Connect the wiring harness to the unit.**
- 6 **Install the unit in your car.**
Make sure that the unit is installed securely in place. If the unit is unstable, it may malfunction (e.g., the sound may skip).
- 7 **Reconnect the ⊖ battery.**
- 8 **Configure <Initial Settings>. (Page 7)**

Installation and Connection

Installing the unit

■ Installing the unit using the mounting bracket removed from the car

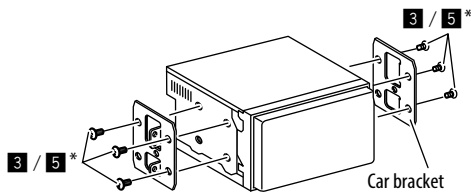

Note: Select the appropriate screws (supplied) for the mounting bracket.

* Only for DDX795/DDX775BH/DDX6018BT/DMX6018BT/
DDX5018BT/DDX595/DDX575BT.

■ Installing the unit using the mounting sleeve

(Only for DDX795/DDX595)

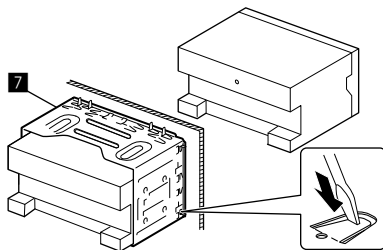

Bend the tabs of the mounting sleeve with a screwdriver or similar utensil and attach it in place.

■ Installing the trim plate

(Only for DDX795/DDX6018BT/DMX6018BT/
DDX5018BT/DDX595)

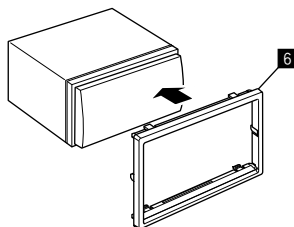

Removing the unit

(Only for DDX795/DDX595)

1 Engage the catch pins on the extraction keys (8) and remove the two locks on the lower part of the trim plate (6).

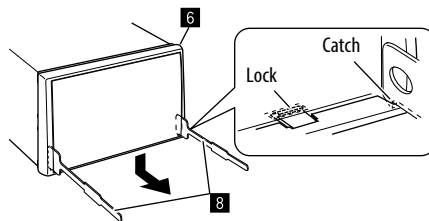

2 Remove from the upper two catches of the trim plate (6).

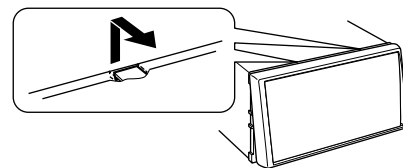

The frame can be removed from the top side in the same manner.

3 Remove the unit by inserting the two extraction keys (8), then pulling them as illustrated.

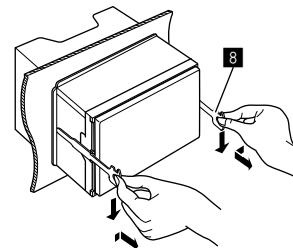

Be careful to avoid injury from the catch pins on the extraction key.

Installation and Connection

Wiring connection

For DDX795/DDX775BH/DDX6018BT/DMX6018BT/DDX5018BT/DDX595/DDX575BT

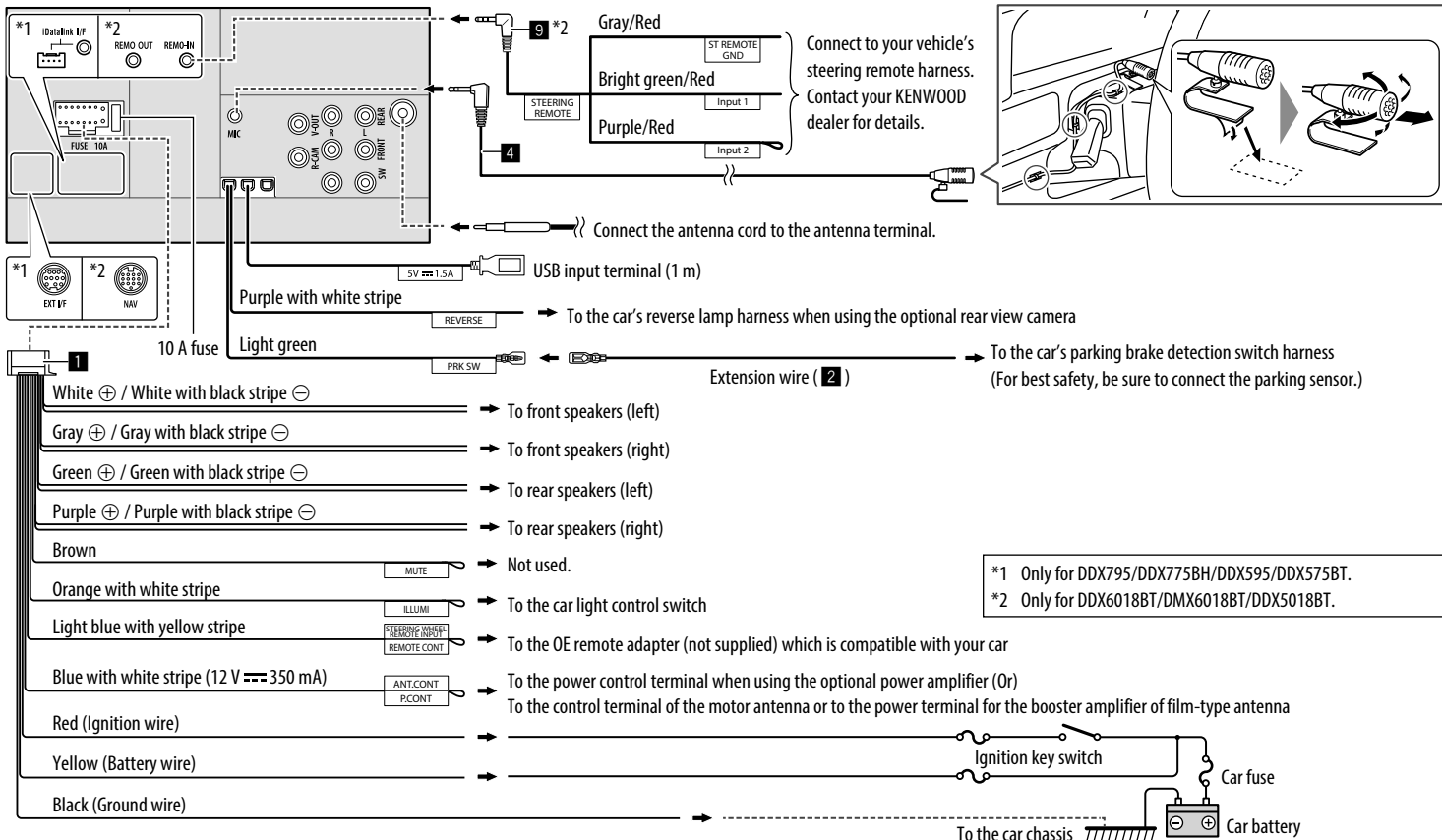

Installation and Connection

For DDX718WBTL

* When using Antenna Control, connect the ANT CONT lead (blue) to A5 (blue) on the wiring harness.

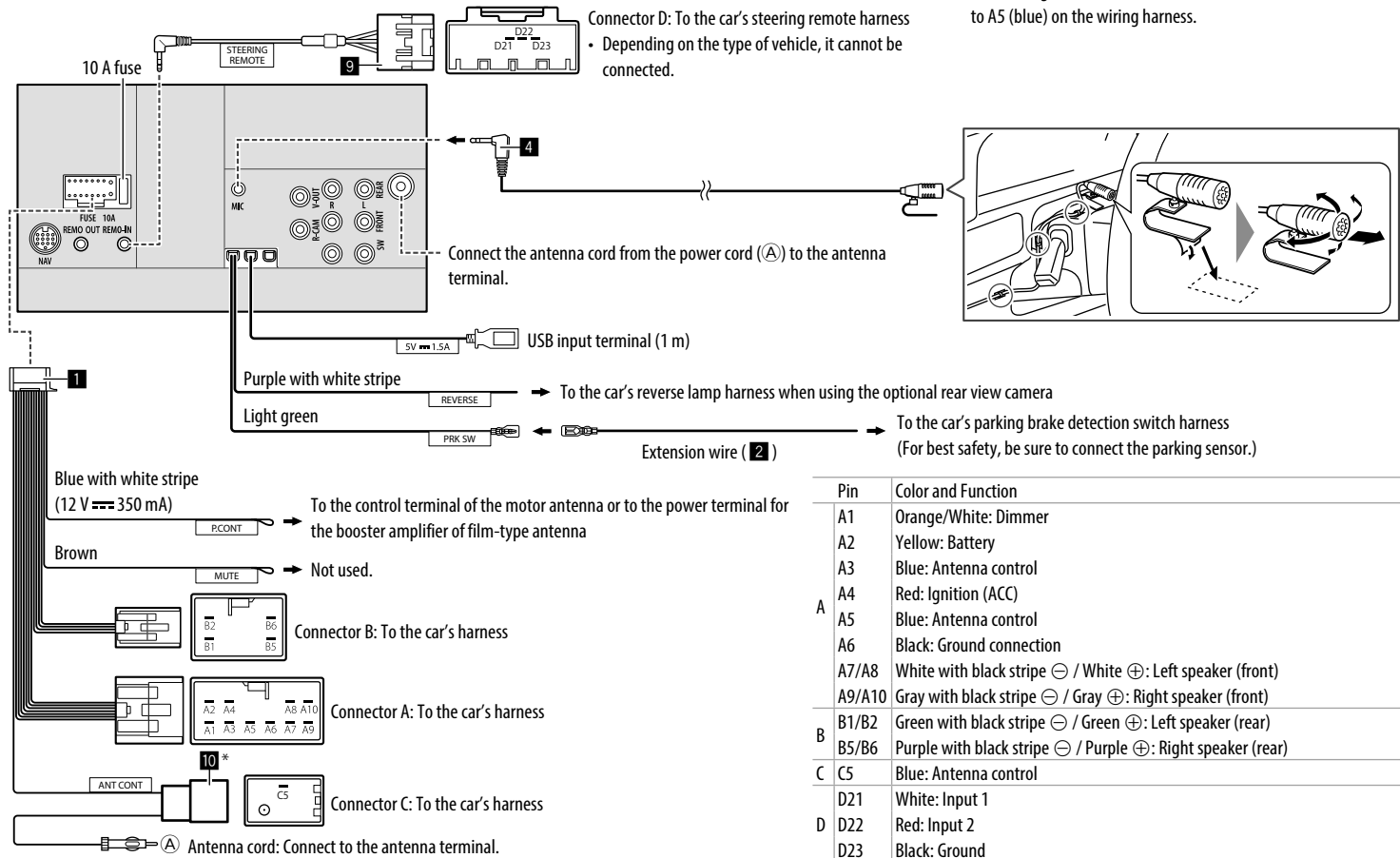

Installation and Connection

For DMX718WBTL

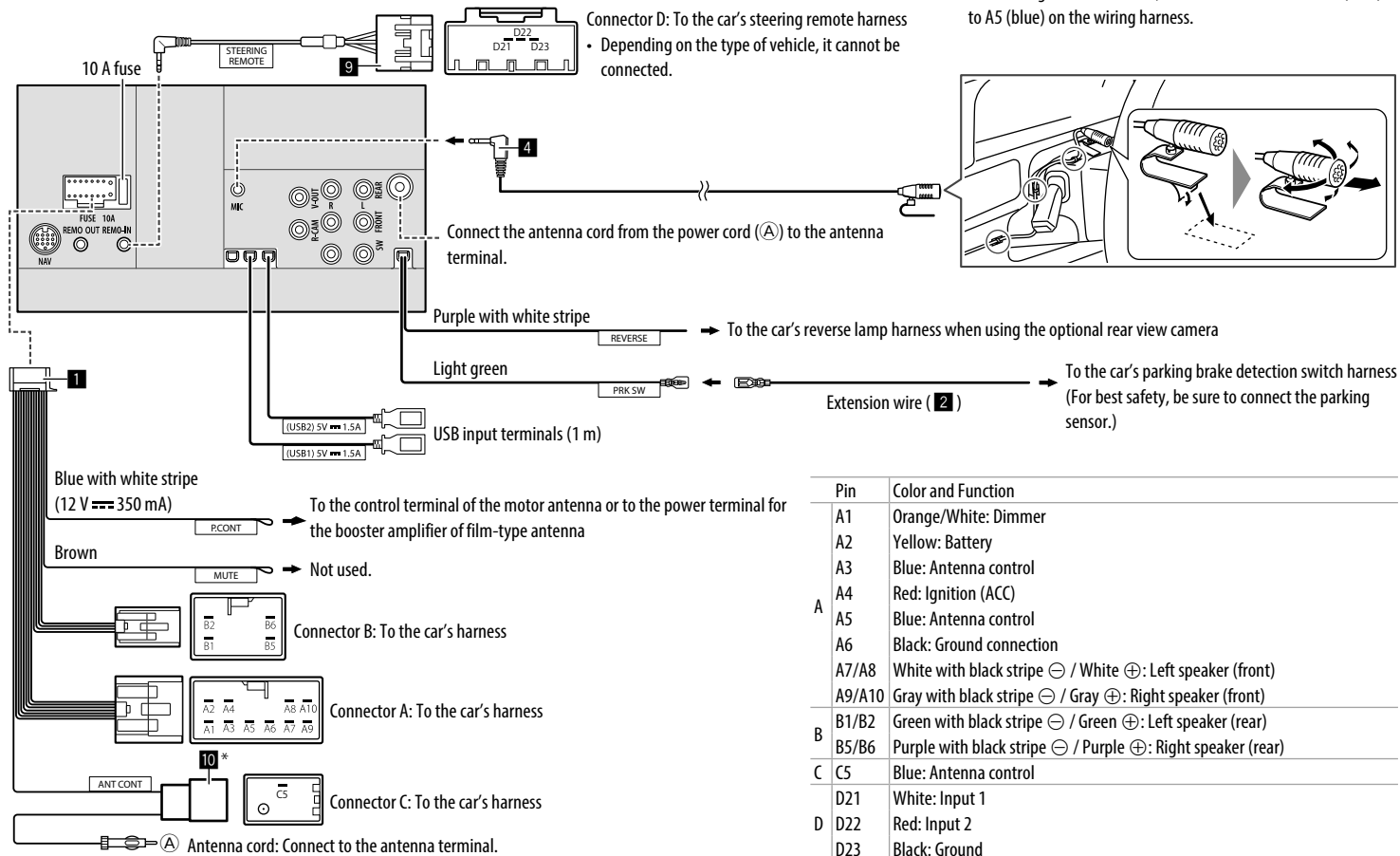

Pin	Color and Function
A1	Orange/White: Dimmer
A2	Yellow: Battery
A3	Blue: Antenna control
A4	Red: Ignition (ACC)
A5	Blue: Antenna control
A6	Black: Ground connection
A7/A8	White with black stripe ⊖ / White ⊕: Left speaker (front)
A9/A10	Gray with black stripe ⊖ / Gray ⊕: Right speaker (front)
B1/B2	Green with black stripe ⊖ / Green ⊕: Left speaker (rear)
B5/B6	Purple with black stripe ⊖ / Purple ⊕: Right speaker (rear)
C5	Blue: Antenna control
D21	White: Input 1
D22	Red: Input 2
D23	Black: Ground

Installation and Connection

Connecting external components

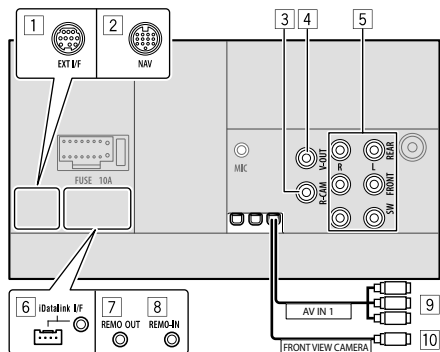

- 1 Expansion port for connecting SiriusXM Connect Vehicle Tuner (EXT I/F) (commercially available)*1
- 2 Navigation input (NAV)*2
- 3 Rear view camera input (R-CAM)
- 4 Video output (V-OUT)
- 5 Output terminals*3
 - Left output (White)
 - Right output (Red)REAR: Rear speaker preouts
FRONT: Front speaker preouts
SW: Subwoofer preouts
- 6 iDataLink input (iDataLink I/F) for connecting an ADS adapter (commercially available)*1

- 7 TV tuner remote control output (REMO OUT)*2
- 8 Steering wheel remote controller input (REMO-IN)*2
 - Connect to the car's steering remote harness using the steering wheel remote input cable (9).
 - Contact your KENWOOD dealer for details.
- 9 Audio video input (AV-IN)*4*5
- 10 Front view camera input (FRONT VIEW CAMERA)*5*6

*1 Only for DDX795/DDX775BH/DDX595/DDX575BT.

*2 Only for DDX6018BT/DMX6018BT/DDX5018BT/DDX718WBTL/DMX718WBTL.

*3 When connecting an external amplifier, connect its ground wire to the chassis of the car; otherwise the unit may be damaged.

*4 Only for DDX6018BT/DMX6018BT/DDX5018BT/DDX718WBTL/DMX718WBTL.

*5 Cable position differs according to the models.

*6 Only for DDX795/DDX775BH/DDX595/DDX575BT/DDX718WBTL/DMX718WBTL.

References

Maintenance

Cleaning the unit

- Do not use any solvent (for example, thinner, benzene, etc.), detergent, or insecticide. This may damage the monitor or the unit.
- Gently wipe the panel with a soft, dry cloth.

Handling discs

- Do not touch the recording surface of the disc.
- Do not stick tape etc. on the disc, or use a disc with tape stuck on it.
- Do not use any accessories for the disc.
- Clean from the center of the disc and move outward.
- Clean the disc with a dry silicone or soft cloth. Do not use any solvents.
- When removing discs from this unit, pull them out horizontally.
- Remove burrs from the center hole and disc edge before inserting a disc.

More information

About playable files

Audio files

- This unit can play back the following files with following codec and extension code:
 - For disc: MP3 (.mp3), WMA (.wma), WAV (.wav), AAC (.m4a)
 - For USB mass storage class device: MP3 (.mp3), WMA (.wma), WAV (.wav), AAC (.m4a), FLAC (.flac)

References

- This unit can play back files that meet the conditions below:
 - Bit Rate:
 - For disc:
 - MP3: 8 kbps – 320 kbps
 - WMA: 5 kbps – 320 kbps
 - AAC: 16 kbps – 320 kbps
 - For USB:
 - MP3/WMA/AAC: 8 kbps – 320 kbps
 - Sampling Frequency:
 - For disc:
 - MP3/AAC: 32 kHz, 44.1 kHz, 48 kHz
 - WMA: 8 kHz, 11.025 kHz, 16 kHz, 22.05 kHz, 32 kHz, 44.1 kHz, 48 kHz
 - WAV: 44.1 kHz
 - For USB:
 - MP3/WMA/AAC: 16 kHz – 48 kHz
 - WAV/FLAC: 16 kHz – 96 kHz
 - Files recorded in VBR (variable bit rate), and have a discrepancy in elapsed time indication
 - This unit can show or display the following:
 - Tag:
 - MP3: ID3 Tag (version 1.0/1.1/2.2/2.3/2.4)
 - WMA Tag
 - WAV Tag
 - AAC Tag
 - FLAC Tag
 - Jacket picture:
 - Picture size: 32 × 32 to 1 232 × 672 resolution
 - Data size: less than 500 KB
 - File type: JPEG/PNG/BMP
 - This unit cannot play back the following files:
 - MP3 files encoded with MP3i and MP3 PRO format.

- MP3 files encoded with Layer 1/2.
- WMA files encoded with lossless, professional, and voice format.
- WMA files which are not based upon Windows Media® Audio.
- WMA/AAC files copy-protected with DRM.
- AAC files copy-protected with FairPlay (except those stored on an iPod/iPhone).
- Files which have data such as AIFF, ATRAC3, etc.

Video files

- This unit can play back the following files with following codec and extension code:
 - For disc: MPEG1/MPEG2 (.mpg, .mpeg)
 - For USB mass storage class device: MPEG1/MPEG2 (.mpg, .mpeg), MPEG4 (.mp4, .m4v), H.264 (.mp4, .m4v, .avi, flv, f4v), WMV (.wmv), MKV (.mkv)
- Streams that conform to:
 - Audio: MP3 or Dolby Audio
 - MPEG1/MPEG2:
 - Audio: MPEG1 Audio Layer-2 or Dolby Audio
 - Video: MPEG system/program stream
- Other playable conditions:
 - MPEG1/MPEG2: File format: MP@ML (Main Profile at Main Level)/SP@ML (Simple Profile at Main Level)/MP@LL (Main Profile at Low Level)
 - Video output format: NTSC (by default)
- This unit can playback a file with the size less than 4 GB.

About disc playback

Playable disc types

- CD-DA: Audio CD
- DVD Video: Region code: 1 or 4 (depending on the country and sales area)
- Dual Disc: DVD side
- VCD: Video CD (PBC compatible)
- DVD Recordable/Rewritable (DVD-R/-RW, +R/+RW)
 - DVD Video: UDF bridge
 - ISO 9660 level 1, level 2, Romeo, Joliet
 - Other playable formats:
 - DVD-R recorded in multi-border format (except for dual layer discs)
 - Finalized +R/+RW (Video format only)
- CD Recordable/Rewritable (CD-R/-RW):
 - ISO 9660 level 1, level 2, Romeo, Joliet
- Other informations:
 - While playing a DVD Video, DTS sound cannot be reproduced or emitted from this unit.
 - This unit can recognize a total of 5 000 files and 250 folders (a maximum of 999 files per folder) in a recordable/rewritable disc.
 - Use only “finalized” recordable/rewritable discs.
 - This unit can play back multi-session recordable/rewritable discs; however, unclosed sessions will be skipped while playing.

References

Unplayable disc types and formats

- DVD-Audio/DVD-ROM discs
- SVCD (Super Video CD), CD Text, CD-ROM, CD-I (CD-I Ready), DTS-CD
- JPEG/PNG/BMP/MPEG4/DivX/FLAC/MKV/H.264/WMV/DVD-VR/DVD+VR/DVD-RAM recorded on DVD-R/-RW or +R/+RW
- JPEG/PNG/BMP/MPEG4/DivX/FLAC/MKV/H.264/WMV recorded on CD-R/-RW
- DVD-RW dual layer discs
- +RW double layer discs
- Non-DVD side of a “DualDisc” which does not comply with the “Compact Disc Digital Audio” standard
- Discs that are not round.
- Discs with coloring on the recording surface or discs that are dirty.
- Recordable/Rewritable discs that have not been finalized.
- 3 inch discs. Attempting to insert these discs using an adapter may cause a malfunction.
- Some recordable/rewritable discs or files may not be played back due to their characteristics or recording conditions.

Language codes (for DVD language selection)

AA	Afar	GD	Scots Gaelic
AB	Abkhazian	GL	Galician
AF	Afrikaans	GN	Guarani
AM	Ameharic	GU	Gujarati
AR	Arabic	HA	Hausa
AS	Assamese	HI	Hindi
AY	Aymara	HR	Croatian
AZ	Azerbaijani	HU	Hungarian
BA	Bashkir	HY	Armenian
BE	Byelorussian	IA	Interlingua
BG	Bulgarian	IE	Interlingue
BH	Bihari	IK	Inupiak
BI	Bislama	IN	Indonesian
BN	Bengali, Bangla	IS	Icelandic
BO	Tibetan	IW	Hebrew
BR	Breton	JA	Japanese
CA	Catalan	JI	Yiddish
CO	Corsican	JW	Javanese
CS	Czech	KA	Georgian
CY	Welsh	KK	Kazakh
DZ	Bhutani	KL	Greenlandic
EL	Greek	KM	Cambodian
EO	Esperanto	KN	Kannada
ET	Estonian	KO	Korean (KOR)
EU	Basque	KS	Kashmiri
FA	Persian	KU	Kurdish
FI	Finnish	KY	Kirghiz
FJ	Fiji	LA	Latin
FO	Faroese	LN	Lingala
FY	Frisian	LO	Laothian
GA	Irish	LT	Lithuanian

LV	Latvian, Lettish	SM	Samoan
MG	Malagasy	SN	Shona
MI	Maori	SO	Somali
MK	Macedonian	SQ	Albanian
ML	Malayalam	SR	Serbian
MN	Mongolian	SS	Siswati
MO	Moldavian	ST	Sesotho
MR	Marathi	SU	Sundanese
MS	Malay (MAY)	SW	Swahili
MT	Maltese	TA	Tamil
MY	Burmese	TE	Telugu
NA	Nauru	TG	Tajik
NE	Nepali	TH	Thai
NO	Norwegian	TI	Tigrinya
OC	Occitan	TK	Turkmen
OM	(Afan) Oromo	TL	Tagalog
OR	Oriya	TN	Setswana
PA	Panjabi	TO	Tonga
PL	Polish	TR	Turkish
PS	Pashto, Pushto	TS	Tsonga
QU	Quechua	TT	Tatar
RM	Rhaeto-Romance	TW	Twi
RN	Kirundi	UK	Ukrainian
RO	Rumanian	UR	Urdu
RW	Kinyarwanda	UZ	Uzbek
SA	Sanskrit	VI	Vietnamese
SD	Sindhi	VO	Volapuk
SG	Sangho	WO	Wolof
SH	Serbo-Croatian	XH	Xhosa
SI	Singhalese	YO	Yoruba
SK	Slovak	ZU	Zulu
SL	Slovenian		

References

About USB playback

Important

Make sure all important data has been backed up to avoid losing the data.

We bear no responsibility for any loss of data stored in the devices while using this unit.

Playable files on a USB device

- This unit can play the following types of files stored in a USB mass storage class device.
 - MPEG1/MPEG2/MPEG4/H.264/WMV/MKV/MP3/WMA/WAV/AAC (.m4a)/FLAC
- This unit can recognize:
 - A total of 5 000 files
 - 250 folders for video files and a maximum of 9 999 files per folder
 - 250 folders for photo files and a maximum of 9 999 files per folder
 - 9 999 folders for audio files and a maximum of 1 000 files per folder
- The maximum number of characters (when the characters are 1 byte):
 - Folder names: 50 characters
 - File names: 50 characters

Notes on using a USB device

- Avoid using the USB device if it might affect driving safety.
- When connecting with a USB cable, use a USB 2.0 cable.

- Electrostatic shock at connecting a USB device may cause abnormal playback of the device. In this case, disconnect the USB device then reset this unit and the USB device.
- Do not pull out and connect the USB device repeatedly while “Reading” is shown on the screen.
- Operation and power supply may not work as intended for some USB devices.
- Do not leave a USB device in the car, or expose to direct sunlight or high temperatures to prevent deformation or damage to the device.

Unplayable USB device

- This unit may not play back files in a USB device properly when using a USB extension cable.
- USB devices equipped with special functions such as data security functions cannot be used with the unit.
- Do not use a USB device with 2 or more partitions.
- Depending on the shape of the USB devices and connection ports, some USB devices may not be attached properly or the connection might be loose.
- This unit may not recognize a memory card inserted into a USB card reader.

About iPod/iPhone

Important

Make sure all important data has been backed up to avoid losing the data.

We bear no responsibility for any loss of data stored in the devices while using this unit.

iPod/iPhone that can be connected

- Made for
 - iPod nano (7th Generation)*
 - iPod touch (6th Generation)
 - iPod touch (5th Generation)
 - iPhone 7 Plus
 - iPhone 7
 - iPhone SE
 - iPhone 6S Plus
 - iPhone 6S
 - iPhone 6 Plus
 - iPhone 6
 - iPhone 5S
 - iPhone 5C
 - iPhone 5

* Available only when connecting via USB input terminal.

Notes on using an iPod/iPhone

- When operating an iPod/iPhone, some operations may not be performed correctly or as intended. In this case, visit the following KENWOOD web site: <www.kenwood.com/cs/ce/>
- When you turn on this unit, the iPod/iPhone is charged through the unit.
- The text information may not be displayed correctly.
- For some iPod/iPhone models, the performance may be abnormal or unstable during operation. In this case, disconnect the iPod/iPhone device, then check its condition.
If the performance is not improved or slow, reset your iPod/iPhone.

Troubleshooting

What appears to be trouble is not always serious. Check the following points before calling a service center.

- For operations with external components, refer also to the instructions supplied with the adapters used for connection (as well as the instructions supplied with the external components).

General

No sound comes out of the speakers.

- Adjust the volume to the optimum level.
- Check the cords and connections.

No picture is displayed on the screen.

- Turn on the screen. (Page 5)

The remote controller* does not work.

- Replace the battery.

* For DDX795/DDX775BH/DDX595/DDX575BT: Purchase optional remote controller, KNA-RCDV331.

“No Signal”/“No Video Signal” appears.

- Start playback on the external component connected to the AV-IN input terminal.
- Check the cords and connections.
- Signal input is too weak.

“Miswiring DC Offset Error”/“Warning DC Offset Error” appears.

- A speaker cord has shorted or it has come into contact with the car chassis. Wire or insulate the speaker cord as appropriate, then reset the unit.

“Parking off” appears.

- No playback picture is shown when the parking brake is not engaged.

“Learning Process Failed” appears.

- Your steering remote controller is not compatible, learning may not be completed. Consult your car audio dealer for details.

“Panel Mecha Error” appears:

- The panel does not work properly. Turn off and on the unit.

Discs

(Only for DDX795/DDX775BH/DDX6018BT/DDX5018BT/DDX595/DDX575BT/DDX718WBTL)

Recordable/Rewritable discs cannot be played back.

- Insert a finalized disc.
- Finalize the discs with the component which you used for recording.

Tracks on the Recordable/Rewritable discs cannot be skipped.

- Insert a finalized disc.
- Finalize the discs with the component which you used for recording.

Playback does not start.

- The format of files is not supported by the unit.

No picture appears on the external monitor.

- Connect the video cord correctly.
- Select the correct input on the external monitor.

MPEG1/MPEG2/MP3/WMA/WAV/AAC discs cannot be played back.

- Record the tracks using a compatible application on the appropriate discs. (Page 67)
- Add appropriate extension codes to the file names.

Tracks on the recordable/rewritable discs are not played back as you have intended them to play.

- Playback order may differ from the one played back using other players.

“Region Code Error” appears.

- You have inserted a DVD Video disc of an incorrect region code. Insert a correct region code disc.

USB

“Reading” does not disappear from the screen.

- Turn the power off and on again.

While playing a track, sound is sometimes interrupted.

- The tracks are not properly copied into the USB device. Copy the tracks again, and try again.

Tracks are not played back as you have intended them to play.

- Playback order may differ from the one played back using other players.

The source does not change to “USB” when you connect a USB device while listening to another source or “USB Device Error” appears when you connect a USB device.

- The USB port is drawing more power than the design limit.
- Turn the power off and unplug the USB device. Then, turn on the power and reattach the USB device.
- If the above does not solve the problem, turn the power off and on (or reset the unit) before replacing with another USB device.

Troubleshooting

iPod/iPhone

No sound comes out of the speakers.

- Disconnect the iPod/iPhone, then connect it again.
- Select another source, then reselect "iPod".

The iPod/iPhone does not turn on or does not work.

- Check the connection.
- Update the firmware version.
- Charge the battery.
- Reset the iPod/iPhone.

Sound is distorted.

- Deactivate the equalizer either on this unit or the iPod/iPhone.

A lot of noise is generated.

- Turn off (uncheck) "VoiceOver" on the iPod/iPhone.
For details, visit <<http://www.apple.com>>.

No operations are available when playing back a track containing artwork.

- Operate the unit after the artwork has loaded.

"Authorization Error" appears.

- Check whether the connected iPod/iPhone is compatible with this unit. (Page 69)

WebLink™

WebLink™ cannot be started.

- Check whether the latest version of WebLink™ App is installed on the connected smartphone.
- Check the connection.
- Charge the battery.
- Reset the smartphone.
- Reconnect your smartphone.

HD Radio

(Only for DDX795/DDX775BH)

AME automatic presetting does not work.

- Store stations manually. (Page 21)

Static noise while listening to the radio.

- Connect the antenna firmly.

Sound quality changes when receiving HD Radio stations.

- Fix the reception mode either to **[Digital]** or **[Analog]**. (Page 20)

No sound can be heard.

- The HD Radio reception mode is not appropriate.
Select the appropriate mode from **[Digital]**, **[Analog]** or **[AUTO]**. (Page 20)

Radio

AME automatic presetting does not work.

- Store stations manually. (Page 24)

Static noise while listening to the radio.

- Connect the antenna firmly.

AV-IN

(Only for DDX6018BT/DMX6018BT/DDX5018BT/DDX718WBTL/DMX718WBTL)

No picture appears on the screen.

- Turn on the video component if it is not on.
- Connect the video component correctly.

Navigation

(Only for DDX6018BT/DMX6018BT/DDX5018BT/DDX718WBTL/DMX718WBTL)

"No Navigation" appears.

- No navigation unit is connected.

Pandora

(Only for DDX795/DDX775BH/DDX595/DDX575BT)

"Check App" appears.

- The Pandora application is not installed on the connected device.

"Our content licenses limit the number of tracks you may skip." appears.

- No more songs can be skipped.

"The maximum number of stations has been created. To create more, please delete one or more previously created stations." appears.

- The station list is full and no more stations can be registered.

"Failed to save your thumb rating" appears.

- Thumb-up/down is prohibited.

Troubleshooting

“Cannot create a Station” appears.

- You cannot create a station during the read-only mode or when network connection is not established.

“Unable to save your bookmark” appears.

- The unit has failed to save a bookmark. Try the operation again.

“Pandora is undergoing maintenance. Please try again later” appears.

- An error has occurred on the Pandora application.

“Station does not exist” appears.

- The selected station has been deleted by another device or has expired.

“Please update Pandora App” appears.

- The Pandora application on the connected device is not the latest version. Update the application.

“Limited Connectivity” appears.

- The connection with the Pandora application cannot be established.

“Pandora not available” appears.

- You cannot use the Pandora application from the area where you are currently trying to access Pandora.

“Unable to play Pandora. When stopped, log-in to Pandora.” appears.

- Pandora application credentials failed to authenticate. Log-out from Pandora, then log-in again.

“No stations. Create some on mobile device when parked.” appears.

- No station is available.

“No Active Station” appears.

- No station is being played.

Spotify

“Check App” appears.

- The Spotify application on the connected device has not started up.
- The Spotify application is not installed on the connected device.
- Reconnect your smartphone.
- Restart Spotify application.

“Please login or sign up.” appears.

- You have not been signed into Spotify.

“Please check internet connection.” appears.

- Check the internet connection.

“Unable to start Spotify.” appears.

- Restart Spotify application.
- Spotify application cannot be started or played in current condition.

“Please update the Spotify app on the phone.” appears.

- The Spotify application on the connected device is not the latest version. Update the application.

SiriusXM Satellite Radio

(Only for DDX795/DDX775BH/DDX595/DDX575BT)

“SXM No Signal” appears.

- Make sure the SiriusXM Satellite Radio antenna is mounted outside the car. Move the car to an area with a clear view of the sky.

“SXM Check Antenna” appears.

- Check the SiriusXM Satellite Radio antenna connection, and make sure the antenna is firmly attached to the tuner.
- Check whether the SiriusXM Satellite Radio antenna cable is bent or broken. If it is damaged, replace the whole antenna unit.

“SXM Check Tuner” appears.

- Make sure the SiriusXM Connect Vehicle Tuner is connected to the unit.

“SXM Chan Unavailable” appears.

- (Appears on the screen for about 5 seconds, then returns to the previous channel)
- The selected channel is no longer available. Select another channel or continue listening to the previous channel.

“SXM Ch Unsubscribed” appears.

- (Appears on the screen for about 5 seconds, then returns to the previous channel)
- The selected channel is not part of your current subscription plan. Call 1-866-635-2349 to subscribe.

“SXM Subscription Updated – Press Return to Continue” appears.

- Your subscription has been updated. Press the appropriate button to continue.

“SXM Channel Locked” appears.

- The selected channel has been locked by the parental controls. Enter the unlock code when you are asked.

“SXM Incorrect Lock Code” appears.

- The selected channel is a mature or parental lock channel, and locked by the parental lock or user lock code. Enter the correct lock code.

Troubleshooting

Bluetooth

Phone sound quality is poor.

- Reduce the distance between the unit and the Bluetooth mobile phone.
- Move the car to a place where you can get a better signal reception.

The sound is interrupted or skipped while using a Bluetooth audio player.

- Reduce the distance between the unit and the Bluetooth audio player. Disconnect the device connected for Bluetooth phone.
- Turn off, then turn on the unit.
(When the sound is not yet restored) connect the player again.

The connected audio player cannot be controlled.

- Check whether the connected audio player supports AVRCP (Audio/Video Remote Control Profile).

The Bluetooth device does not detect the unit.

- Search from the Bluetooth device again.

The unit does not pair with the Bluetooth device.

- For devices compatible with Bluetooth 2.1: Register the device using a PIN code. (Page 40)
- For devices compatible with Bluetooth 2.0: Enter the same PIN code for both the unit and target device. If the PIN code of the device is not indicated in its instructions, try "0000" or "1234."
- Turn off, then turn on the Bluetooth device.

Echo or noise occurs.

- Adjust the microphone unit position.
- Adjust the echo volume or noise reduction volume. (Page 42)

The unit does not respond when you try to copy the phonebook to the unit.

- You may have tried to copy the same entries (as stored) to the unit.

"Connection Error" appears.

- The device is registered but the connection has failed. Connect the registered device. (Page 41)

"Please Wait..." appears.

- The unit is preparing to use the Bluetooth function. If the message does not disappear, turn off and turn on the unit, then connect the device again (or reset the unit).

"No Voice Device" appears.

- The connected mobile phone does not have a voice recognition system.

"No Data" appears.

- No phonebook data is contained in the connected Bluetooth phone.

"Initialize Error" appears.

- The unit has failed to initialize the Bluetooth module. Try the operation again.

"Dial Error" appears.

- Dialing has failed. Try the operation again.

"Hung Up Error" appears.

- The call has not ended yet. Park your car, and use the connected mobile phone to end the call.

"Pick Up Error" appears.

- The unit has failed to receive a call.

Specifications

■ Monitor section

Picture Size (W × H)	DDX795/DDX775BH/ DDX6018BT/DMX6018BT/ DDX718WBTL/DMX718WBTL: 6.95 inches (diagonal) wide 156.6 mm × 81.6 mm (6-3/16" × 3-3/16") DDX5018BT/DDX595/ DDX575BT: 6.2 inches (diagonal) wide 137.5 mm × 77.2 mm (5-7/16" × 3-1/16")
Display System	Transparent TN LCD panel
Drive System	TFT active matrix system
Number of Pixels	1 152 000 (800H × 480V × RGB)
Effective Pixels	99.99%
Pixel Arrangement	RGB striped arrangement
Back Lighting	LED

Specifications

DVD player section

(Only for DDX795/DDX775BH/DDX6018BT/
DDX5018BT/DDX595/DDX575BT/DDX718WBTL)

D/A Converter	24 bit
Audio Decoder	Linear PCM/Dolby Audio/MP3/ WMA/WAV/AAC (.m4a)
Video Decoder	MPEG1/MPEG2
Wow & Flutter	Below Measurable Limit
Frequency Response	96 kHz Sampling: 20 Hz to 20 000 Hz 48 kHz Sampling: 20 Hz to 20 000 Hz 44.1 kHz Sampling: 20 Hz to 20 000 Hz
Total Harmonic Distortion	0.010% (1 kHz)
Signal to Noise Ratio	82 dB (DVD-Video 96 kHz)
Dynamic Range	81 dB (DVD-Video 96 kHz)
Disc Format	DVD-Video/VIDEO-CD/CD-DA
Sampling Frequency	44.1 kHz/48 kHz/96 kHz
Quantifying Bit Number	16 bit/20 bit/24 bit

USB interface section

USB Standard	USB 2.0 Full Speed/High Speed
Compatible Device	Mass Storage Class
File System	FAT 16/FAT 32/NTFS
Maximum Power Supply Current	DDX795/DDX775BH/ DDX6018BT/DMX6018BT/ DDX5018BT/DDX595/ DDX575BT/DDX718WBTL: DC 5 V $\overline{\text{V}}$ 1.5 A (x 1) DMX718WBTL: DC 5 V $\overline{\text{V}}$ 1.5 A (x 2)
D/A Converter	24 bit
Audio Decoder	MP3/WMA/AAC (.m4a)/WAV/ FLAC
Video Decoder	MPEG1/MPEG2/MPEG4/ H.264/WMV/MKV
Frequency Response	96 kHz Sampling: 20 Hz to 20 000 Hz 48 kHz Sampling: 20 Hz to 20 000 Hz 44.1 kHz Sampling: 20 Hz to 20 000 Hz
Total Harmonic Distortion	0.020% (1 kHz)
Signal to Noise Ratio	104 dB
Dynamic Range	90 dB

Bluetooth section

Technology	Bluetooth 3.0
Frequency	2.402 GHz to 2.480 GHz
Output Power	+4 dBm (MAX), 0 dBm (AVE), Power Class 2
Maximum Communication Range	Line of sight approx. 10 m (32.8 ft)
Audio Codec	SBC/AAC
Profile	HFP (Hands Free Profile) 1.6 A2DP (Advanced Audio Distribution Profile) 1.3 AVRCP (Audio/Video Remote Control Profile) 1.5 GAP (Generic Access Profile) PBAP (PhoneBook Access Profile) 1.2 SDP (Service Discovery Profile) SPP (Serial Port Profile) 1.2

Specifications

FM tuner section

Frequency Range	DDX795/DDX775BH/DDX595/ DDX575BT: 87.9 MHz to 107.9 MHz (200 kHz) DDX6018BT/DMX6018BT/ DDX5018BT/DDX718WBTL/ DMX718WBTL: 87.5 MHz to 108.0 MHz (50 kHz)
Usable Sensitivity (S/N: 30 dB, Dev. 22.5 kHz)	7.2 dBf (0.63 μ V/75 Ω)
Quieting Sensitivity (DIN S/N: 46 dB, Dev. 40 kHz)	15.2 dBf (1.58 μ V/75 Ω)
Frequency Response (\pm 3.0 dB)	Digital: 20 Hz to 20 kHz* Analog: 30 Hz to 15 kHz
Signal to Noise Ratio	Digital: 75 dB (STEREO)* Analog: 68 dB (MONO)
Selectivity (\pm 400 kHz)	> 80 dB
Stereo Separation	40 dB (1 kHz)

* Only for DDX795/DDX775BH.

AM tuner section

Frequency Range	530 kHz to 1 700 kHz (10 kHz)
Usable Sensitivity	29 dB μ
Frequency Response (\pm 3.0 dB)	Digital: 40 Hz to 15 kHz*
Signal to Noise Ratio	Digital: 75 dB (STEREO)*

* Only for DDX795/DDX775BH.

Video section

Color System of External Video Input	NTSC/PAL
External Video Input Level (RCA jack)*	1 Vp-p/75 Ω
External Audio Max Input Level (RCA jack)*	2 V/25 k Ω
Video Input Level for Rear Camera (RCA jack)	1 Vp-p/75 Ω
Video Output Level (RCA jack)	1 Vp-p/75 Ω
Analog RGB Input*	0.7 Vp-p/75 Ω

* Only for DDX6018BT/DMX6018BT/DDX5018BT/DDX718WBTL/
DMX718WBTL.

Audio section

Maximum Power (Front & Rear)	50 W \times 4
Full Bandwidth Power (Front & Rear)	22 W \times 4 (at less than 1% THD)
Preout Level	DDX795/DDX595: 5 V/10 k Ω DDX775BH/DDX6018BT/ DMX6018BT/DDX5018BT/ DDX575BT/DDX718WBTL/ DMX718WBTL: 4 V/10 k Ω
Preout Impedance	\leq 600 Ω
Speaker Impedance	4 Ω to 8 Ω
Equalizer	Band: 13 Band Frequency (Hz): 62.5/100/160/250/400/630/ 1k/1.6k/2.5k/4k/6.3k/10k/ 16k Gain (dB): -9/-8/-7/-6/-5/-4/-3/-2/ -1/0/1/2/3/4/5/6/7/8/9

Specifications

2 Way X'Over

Tweeter:	Gain (dB): -8/-7/-6/-5/-4/-3/-2/-1/0
Front/Rear (HPF):	Frequency (Hz): Through/30/40/50/60/70/ 80/90/100/120/150/180/ 220/250 Slope (dB/Oct): -6/-12/-18/-24 Gain (dB): -8/-7/-6/-5/-4/-3/-2/-1/0
Subwoofer (LPF):	Frequency (Hz): 30/40/50/60/70/80/90/100/ 120/150/180/220/250/ Through Slope (dB/Oct): -6/-12/-18/-24 Phase: Phase Inversion: Off/On Gain (dB): -8/-7/-6/-5/-4/-3/-2/-1/0

Position	Front/Rear/Subwoofer Delay: DDX795/DDX775BH/DDX595/ DDX575BT: 0 ft to 20.01 ft (0.03 ft Step) DDX6018BT/DMX6018BT/ DDX5018BT/DDX718WBTL/ DMX718WBTL: 0 cm to 610 cm (1.0 cm Step) Gain: -8 dB to 0 dB
----------	--

Subwoofer Level	-50 dB to +10 dB
-----------------	------------------

General

Operating Voltage	14.4 V (10.5 V to 16 V allowable)
Maximum Current Consumption	10 A
Installation Dimensions (W × H × D)	DDX795/DDX595: With sleeve: 182 mm × 111 mm × 160 mm (7-3/16" × 4-3/8" × 6-5/16") Without sleeve: 178 mm × 100 mm × 162 mm (7" × 3-15/16" × 6-3/8") DDX775BH/DDX6018BT/ DMX6018BT/DDX5018BT/ DDX575BT: 178 mm × 100 mm × 162 mm (7" × 3-15/16" × 6-3/8") DDX718WBTL/DMX718WBTL: 178 mm × 100 mm × 162 mm (7" × 3-15/16" × 6-3/8") 206 mm × 104 mm × 162 mm (8-1/8" × 4-1/8" × 6-3/8") (including the sub panel part)

Operational Temperature Range	-10°C to +60°C
Weight (Main Unit)	DDX795: 2.7 kg (6.0 lbs) (including trim plate and sleeve) DDX775BH/DDX718WBTL: 2.4 kg (5.3 lbs) DDX6018BT: 2.4 kg (5.3 lbs) (including trim plate) DMX6018BT 2.0 kg (4.5 lbs) (including trim plate) DDX5018BT: 1.9 kg (4.2 lbs) (including trim plate) DDX595: 2.1 kg (4.7 lbs) (including trim plate and sleeve) DDX575BT: 1.8 kg (4.0 lbs) DMX718WBTL: 2.0 kg (4.5 lbs)

Design and specifications are subject to change without notice.

Specifications

Trademarks and licenses

- Dolby, Dolby Audio and the double-D symbol are trademarks of Dolby Laboratories.
- “DVD Logo” is a trademark of DVD Format/Logo Licensing Corporation registered in the US, Japan and other countries.
- The “AAC” logo is a trademark of Dolby Laboratories.
- Microsoft and Windows Media are either registered trademarks or trademarks of Microsoft Corporation in the United States and/or other countries.
- “Made for iPod,” and “Made for iPhone” mean that an electronic accessory has been designed to connect specifically to iPod, or iPhone, respectively, and has been certified by the developer to meet Apple performance standards.
Apple is not responsible for the operation of this device or its compliance with safety and regulatory standards. Please note that the use of this accessory with iPod, or iPhone may affect wireless performance. iTunes, iPhone, iPod, iPod classic, iPod nano, and iPod touch are trademarks of Apple Inc., registered in the U.S. and other countries.
- Lightning is a trademark of Apple Inc.
- This item incorporates copy protection technology that is protected by U.S. patents and other intellectual property rights of Rovi Corporation. Reverse engineering and disassembly are prohibited.
- Android is a trademark of Google Inc.
- The Bluetooth® word mark and logos are registered trademarks owned by Bluetooth SIG, Inc. and any use of such marks by JVC KENWOOD Corporation is under license. Other trademarks and trade names are those of their respective owners.

- THIS PRODUCT IS LICENSED UNDER THE AVC PATENT PORTFOLIO LICENSE FOR THE PERSONAL USE OF A CONSUMER OR OTHER USES IN WHICH IT DOES NOT RECEIVE REMUNERATION TO
(i) ENCODE VIDEO IN COMPLIANCE WITH THE AVC STANDARD (“AVC VIDEO”) AND/OR (ii) DECODE AVC VIDEO THAT WAS ENCODED BY A CONSUMER ENGAGED IN A PERSONAL ACTIVITY AND/OR WAS OBTAINED FROM A VIDEO PROVIDER LICENSED TO PROVIDE AVC VIDEO. NO LICENSE IS GRANTED OR SHALL BE IMPLIED FOR ANY OTHER USE. ADDITIONAL INFORMATION MAY BE OBTAINED FROM MPEG LA, L.L.C. SEE [HTTP://WWW.MPEGLA.COM](http://www.mpegla.com)
- Sirius, XM and all related marks and logos are trademarks of Sirius XM Radio Inc. All rights reserved.
- HD Radio Technology manufactured under license from iBiquity Digital Corporation. U.S. and Foreign Patents. For patents see <http://dts.com/patents>. HD Radio and the HD, HD Radio, and “ARC” logos are registered trademarks or trademarks of iBiquity Digital Corporation in the United States and/or other countries.
- Pandora, the Pandora logo, and the Pandora trade dress are trademarks or registered trademarks of Pandora Media, Inc., used with permission.
- SPOTIFY and the Spotify logo are among the registered trademarks of Spotify AB.
- WebLink™ is a trademark of Abalta Technologies, Inc.
- YouTube and the YouTube logo are registered trademarks of Google Inc.

- libFLAC
Copyright (C) 2000-2009 Josh Coalson
Copyright (C) 2011-2013 Xiph.Org Foundation
Redistribution and use in source and binary forms, with or without modification, are permitted provided that the following conditions are met:
 - Redistributions of source code must retain the above copyright notice, this list of conditions and the following disclaimer.
 - Redistributions in binary form must reproduce the above copyright notice, this list of conditions and the following disclaimer in the documentation and/or other materials provided with the distribution.
 - Neither the name of the Xiph.org Foundation nor the names of its contributors may be used to endorse or promote products derived from this software without specific prior written permission.
- THIS SOFTWARE IS PROVIDED BY THE COPYRIGHT HOLDERS AND CONTRIBUTORS “AS IS” AND ANY EXPRESS OR IMPLIED WARRANTIES, INCLUDING, BUT NOT LIMITED TO, THE IMPLIED WARRANTIES OF MERCHANTABILITY AND FITNESS FOR A PARTICULAR PURPOSE ARE DISCLAIMED. IN NO EVENT SHALL THE FOUNDATION OR CONTRIBUTORS BE LIABLE FOR ANY DIRECT, INDIRECT, INCIDENTAL, SPECIAL, EXEMPLARY, OR CONSEQUENTIAL DAMAGES (INCLUDING, BUT NOT LIMITED TO, PROCUREMENT OF SUBSTITUTE GOODS OR SERVICES; LOSS OF USE, DATA, OR PROFITS; OR BUSINESS INTERRUPTION) HOWEVER CAUSED AND ON ANY THEORY OF LIABILITY, WHETHER IN CONTRACT, STRICT LIABILITY, OR TORT (INCLUDING NEGLIGENCE OR OTHERWISE) ARISING IN ANY WAY OUT OF THE USE OF THIS SOFTWARE, EVEN IF ADVISED OF THE POSSIBILITY OF SUCH DAMAGE.

For updated information (the latest Instruction Manual, system updates, new functions, etc.),
please visit the following website:

www.kenwood.com/cs/ce/



HD Radio®

This HD Radio receiver enables:

HD2/HD3)

Digital Sound)

Program Info)

Emergency Alerts)

Made for
 iPod iPhone

DOLBY AUDIO™

Bluetooth®