

KENWOOD

NX-5000 series

USER MANUAL

The picture shows the model with an operation panel attached.



JVCKENWOOD Corporation

B5A-0395-40/05 (K)

CONTENTS

| | |
|--|-----------|
| SCREEN DISPLAY | 3 |
| BASIC OPERATIONS | 4 |
| SWITCHING POWER ON/ OFF | 4 |
| ADJUSTING THE VOLUME | 5 |
| SELECTING A ZONE AND CHANNEL | 5 |
| TRANSMITTING | 6 |
| RECEIVING | 13 |
| PROGRAMMABLE FUNCTIONS | 15 |
| FUNCTIONS OVERVIEW | 27 |
| FUNCTION DETAILS | 40 |
| SCAN | 40 |
| DTMF (DUAL TONE MULTI FREQUENCY) CALLS | 43 |
| TRUNKING CALLS | 44 |
| EMERGENCY CALLS | 46 |
| SCRAMBLER (ANALOG/ LTR)/ ENCRYPTION (P25/ NXDN/ DMR) | 47 |
| SIGNALING | 49 |
| CLOCK | 51 |
| COLOR SCHEME | 52 |
| MULTI RF DECK VIEW | 53 |
| MULTI LANGUAGE | 55 |
| FleetSync: ALPHANUMERIC 2-WAY PAGING FUNCTION | 56 |
| VOICE OPERATED TRANSMISSION (VOX) | 59 |
| BACKGROUND OPERATIONS | 60 |
| Bluetooth | 63 |
| microSD CARD & BUILT-IN MEMORY | 75 |
| INDICATOR LIST | 82 |

This manual has been prepared based on basic settings. Depending on the setting, the descriptions provided may be different from the actual operations.

SCREEN DISPLAY

The display on the screen differs as follows depending on the type of panel used.

■ When the attached panel or KCH-19 (Basic Panel) is used

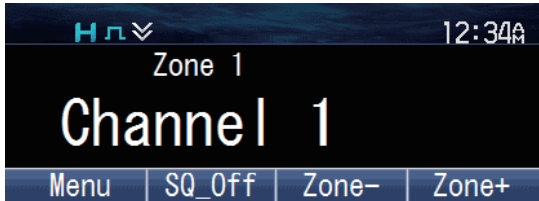

■ When KCH-20R (Featured Panel) is used

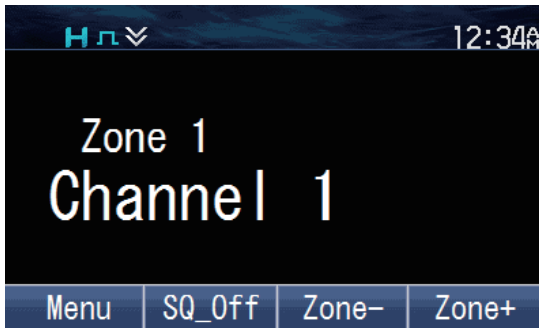

■ When KCH-21R (Handheld Control Head) is used



BASIC OPERATIONS

SWITCHING POWER ON/ OFF

Press [⏻] to switch the transceiver ON.

- The following screen appears if the Custom Start-up Screen has not been set.

Press [⏻] again to switch the transceiver OFF.



■ Transceiver Password

If the transceiver is password protected, “**Input Password**” will appear on the display when the power is turned on. To unlock the transceiver, enter the correct password.

- 1 Press the key programmed as [**Transceiver Password**] to enter Transceiver Password Mode.

Alternatively, press the key programmed as [**Menu**] to enter Transceiver Password Mode using the Menu Mode.

- If a password has been registered and the [**Transceiver Password**] function has not been programmed to a key or configured to the menu, the transceiver enters Transceiver Password Mode when the power is turned on.

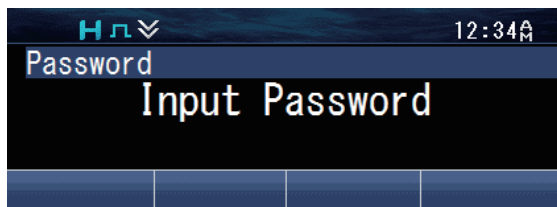

- 2 Enter a number using the [▲] and [▼] keys.

- On an optional microphone with keypad, you can enter the password directly by pressing the keypad.

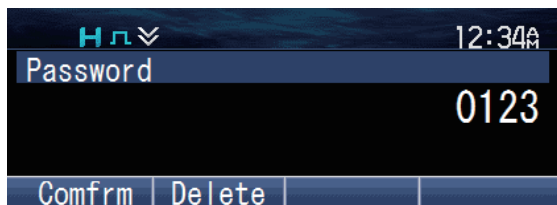

- 3 Press the [OK] key to accept the number.
- 4 Repeat steps 2 and 3 to enter the entire password.
 - Press the [DEL] key to delete an incorrectly entered number. Press and hold the [DEL] key to delete all numbers.
- 5 Press the [OK] key to confirm the entry.
 - If you enter an incorrect password, an error tone sounds and the transceiver remains locked.
 - The password can contain a maximum of 6 digits.

ADJUSTING THE VOLUME

Press the key programmed as **[Volume Up]** to increase the volume. Press the key programmed as **[Volume Down]** to decrease the volume.

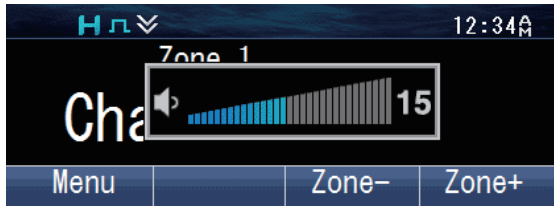

SELECTING A ZONE AND CHANNEL

- 1 Select the desired zone using the keys programmed as **[Zone Up]**/ **[Zone Down]**. Each zone contains a group of channels.



- 2 Select the desired channel using the keys programmed as **[Channel Up]**/ **[Channel Down]**. Each channel is programmed with settings for transmitting and receiving.
 - The transceiver may have names programmed for zones and channels. The zone name and channel name can contain up to 16 and 14 characters respectively.

TRANSMITTING

- 1 Select the desired zone and channel using the keys programmed as **[Zone Up]**/**[Zone Down]** and **[Channel Up]**/**[Channel Down]**.

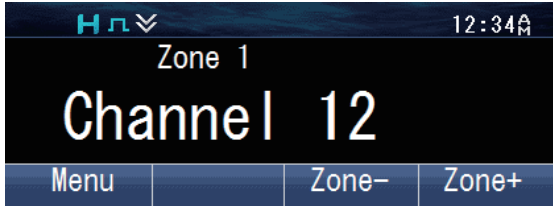

- 2 Press the **PTT** switch and speak into the microphone. Release the **PTT** switch to receive.
 - The LED indicator lights red while transmitting and green while receiving a signal. This indicator can also be disabled by your dealer.
 - For best sound quality at the receiving station, hold the microphone approximately 1.5 inches (3 cm to 4 cm) from your mouth.

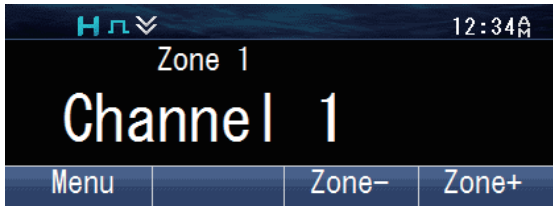

■ Making Group Calls (P25 Conventional)

You can select a Talkgroup ID from the list to make a call to those parties on a Conventional channel.

- 1 Press the key programmed as **[Group]**, **[Group + Status]** or **[Group + Short Message]** to enter Talkgroup ID Select Mode.

Alternatively, press the key programmed as **[Menu]** to enter Talkgroup ID Select Mode using the Menu Mode.

- The Talkgroup ID List appears on the display.

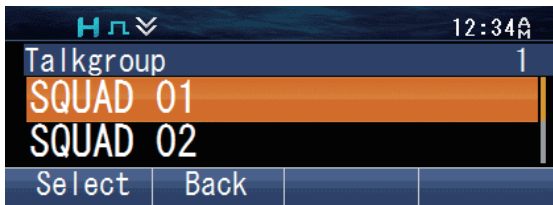

- 2 Press the [▲] and [▼] keys to select a Talkgroup ID from the list that has been pre-entered into your transceiver.

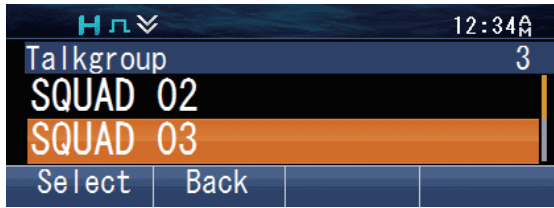

- 3 Press the [□] key to confirm the Talkgroup ID.
- 4 Press and hold the **PTT** switch to make the call.
 - Speak into the transceiver as you would during a normal call.

■ Making Individual Calls (P25 Conventional)

You can make calls to specific persons on a Conventional channel.

- 1 Press the key programmed as [**Individual**], [**Individual + Status**] or [**Individual + Short Message**] to enter Individual Call Mode. Alternatively, press the key programmed as [**Menu**] to enter Individual Call Mode using the Menu Mode.
 - The Individual ID List appears on the display.



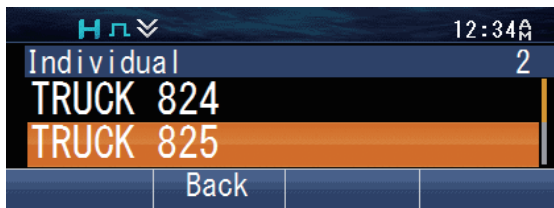

- 2 Press the [▲] and [▼] keys to select a unit ID from the list that has been pre-entered into your transceiver.

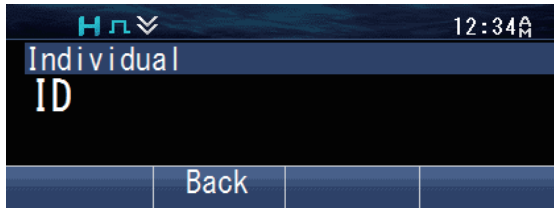

Alternatively, you can enter a unit ID manually.

- Press the [○] key to enter the manual input mode. Press the [▲] and [▼] keys to enter the code. Press the [□] key to confirm each entered digit. On an optional microphone with keypad, you can enter the code directly. To delete the code entered, press the [↵] key to delete one digit, or press and hold the [↵] key to delete all digits.



- 3 Press and hold the **PTT** switch to make the call.
 - The “” icon blinks. “**Individual**” and the ID name of the target transceiver are displayed.

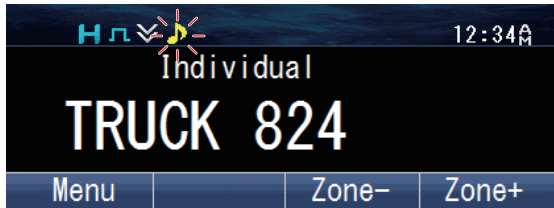

- Speak into the transceiver as you would during a normal call.

■ Making Group Calls (P25 Trunking)

You can select a channel with the Talkgroup ID you wanted to call to make a call to those parties on a Trunking channel.

- If the traffic channel is busy, a busy message appears and the busy tone sounds. Release the **PTT** switch and wait for the channel to become free. When the traffic channel becomes free, a proceed tone sounds.

- 1 Select the configured Talkgroup channel using the keys programmed as **[Channel Up]**/ **[Channel Down]**.

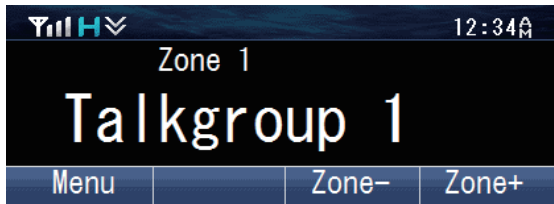

- 2 Press and hold the **PTT** switch to make the call.
 - “**Calling**” appears on the display while the call is being made, and disappears once the call is established.

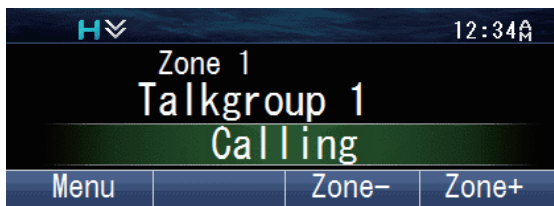

- Speak into the transceiver as you would during a normal call.

■ Making Individual Calls (P25 Trunking)

You can make calls to specific persons on a Trunking channel.

- 1 Press the key programmed as [**Individual**], [**Individual + Status**] or [**Individual + Short Message**] to enter Individual Call Mode.

Alternatively, press the key programmed as [**Menu**] to enter Individual Call Mode using the Menu Mode.

- 2 Press the [**▲**] and [**▼**] keys to select a unit ID from the list that has been pre-entered into your transceiver.
 - The target unit ID/ name appears on the display.

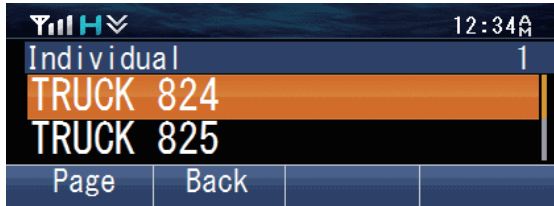

Alternatively, you can enter a unit ID manually.

- Press the [**O**] key to enter the manual input mode. Press the [**▲**] and [**▼**] keys to enter the code. Press the [**□**] key to confirm each entered digit. On an optional microphone with keypad, you can enter the code directly. To delete the code entered, press the [**↵**] key to delete one digit, or press and hold the [**↵**] key to delete all digits.

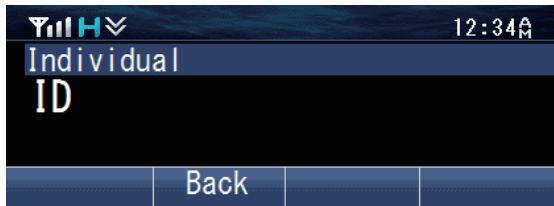

- 3 Press and hold the **PTT** switch to make the call.
 - The called ID and "**Calling**" appear on the display. "**Calling**" disappears once the call is established.
 - Speak into the transceiver as you would during a normal call.
- 4 To end the call, press the key programmed as [**Clear**].
 - The LCD display will return to the zone and channel screen after call ends.

■ Making Group Calls (NXDN Conventional/ DMR Conventional)

You can select a group ID from the list to make a call to those parties on a Conventional channel.

- 1 Press the key programmed as **[Group]**, **[Group + Short Message]** or **[Group + Status]** to enter Group Call Mode.

Alternatively, press the key programmed as **[Menu]** to enter Group Call Mode using the Menu Mode.

- The group ID list appears on the display.

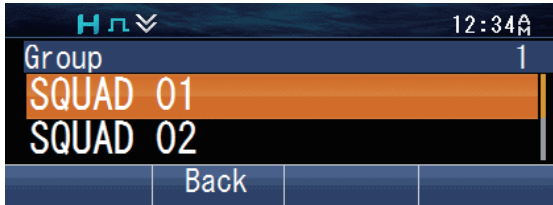

- 2 Press the **[▲]** and **[▼]** keys to select a Group ID/ name from the list that has been pre-entered into your transceiver.

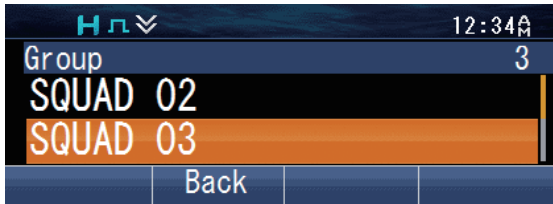

- 3 Press and hold the **PTT** switch to make the call.

- The “” icon blinks. “**Group**” and the Group name of the target transceiver are displayed.



- Speak into the transceiver as you would during a normal call.

■ Making Individual Calls (NXDN Conventional/ DMR Conventional)

You can make calls to specific persons.

- 1 Press the key programmed as **[Individual]**, **[Individual + Short Message]** or **[Individual + Status]** to enter Individual Call Mode.

Alternatively, press the key programmed as **[Menu]** to enter Individual Call Mode using the Menu Mode.

- The ID list appears on the display.

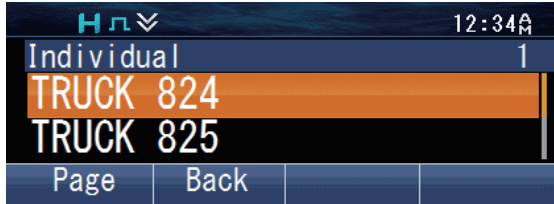

- 2 Press the **[▲]** and **[▼]** keys to select a unit ID from the list that has been pre-entered into your transceiver.

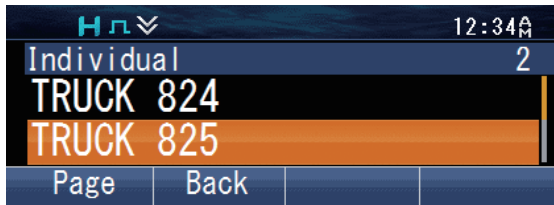

Alternatively, you can enter a unit ID manually.

- Press the **[O]** key to enter the manual input mode. Press the **[▲]** and **[▼]** keys to enter the code. Press the **[□]** key to confirm each entered digit.

On an optional microphone with keypad, you can enter the code directly.

To delete the code entered, press the **[↵]** key to delete one digit, or press and hold the **[↵]** key to delete all digits.

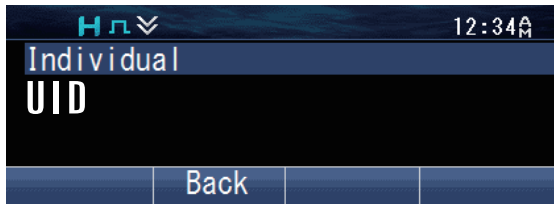

- 3 Press and hold the **PTT** switch to make the call.

- The “” icon blinks. “Individual” and the ID name of the target transceiver are displayed.

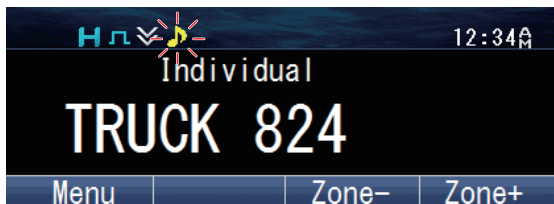

- Speak into the transceiver as you would during a normal call.

■ Making Group Calls (NXDN Trunking)

You can select a channel with the Group ID you wanted to call to make a call to those parties on a Trunking channel.

- If the traffic channel is busy, a busy message appears and the busy tone sounds. Release the **PTT** switch and wait for the channel to become free. When the traffic channel becomes free, a proceed tone sounds.
- 1 Select the configured Group channel using the keys programmed as [**Channel Up**]/[**Channel Down**].

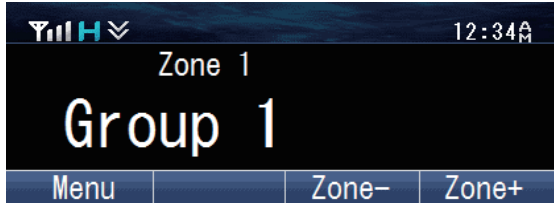

- 2 Press and hold the **PTT** switch to make the call.
 - “**Calling**” appears on the display while the call is being made, and disappears once the call is established.

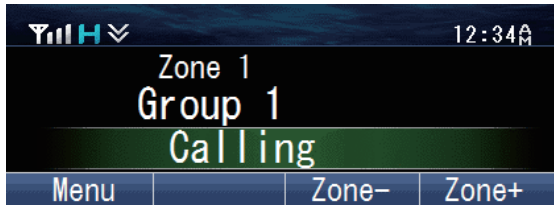

- Speak into the transceiver as you would during a normal call.

■ Making Individual Calls (NXDN Trunking)

You can make calls to specific persons on a Trunking channel.

- 1 Press the key programmed as [**Individual**], [**Individual + Short Message**] or [**Individual + Status**] to enter Individual Call Mode.
Alternatively, press the key programmed as [**Menu**] to enter Individual Call Mode using the Menu Mode.
 - The ID list appears on the display.

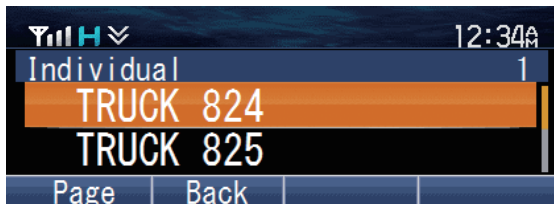

- 2 Press the [▲] and [▼] keys to select a unit ID from the list that has been pre-entered into your transceiver.



Alternatively, you can enter a unit ID manually.

- Press the [O] key to enter the manual input mode. Press the [▲] and [▼] keys to enter the code. Press the [□] key to confirm each entered digit.

On an optional microphone with keypad, you can enter the code directly.

To delete the code entered, press the [↵] key to delete one digit, or press and hold the [↵] key to delete all digits.

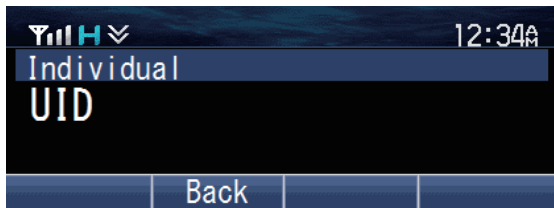

- 3 Press and hold the **PTT** switch to make the call.
 - “**Individual**” and the ID name of the target transceiver are displayed. “**Calling**” appears on the display while the call is being made, and disappears once the call is established.
 - Speak into the transceiver as you would during a normal call.

RECEIVING

- 1 Select the desired zone and channel using the keys programmed as [Zone Up]/ [Zone Down] or [Channel Up]/ [Channel Down]. (If the Scan function has been programmed, you can switch it on or off as desired.)
- 2 When you hear the caller’s voice, readjust the volume as necessary.
 - If signaling has been programmed on the selected channel, you will hear a call only if the signal tone matches the tone set up on your transceiver.

Note:

- Signaling allows your transceiver to code your calls. This will prevent you from listening to unwanted calls. It does not make calls private, it only prevents them from being heard by transceivers set with a different signaling code. Refer to “SIGNALING” {p. 49} for details.
 - A ringing tone will sound when receiving a call if the alert tone has been enabled in the Alert Tone setting. For details, consult your dealer.
-

■ Receiving Group Calls (P25)

When you receive a group call on a Conventional channel and the received group ID matches the ID set up on your transceiver, you can hear the caller's voice.

When you receive a group call on a Trunking channel, the transceiver automatically switches to the traffic channel to receive the call.

■ Receiving Individual Calls (P25)

When you receive an individual call on a Conventional channel, a ringing tone will sound and the display will show the caller's ID. To respond to the call, press and hold the **PTT** switch and speak into the transceiver as you would during a normal call.

When you receive an individual call on a Trunking channel, a ringing tone will sound and the caller's ID appears on the display. To receive the call, press the **PTT** switch. To deny the call, press the key programmed as **[Clear]**. After receiving the call, you can respond to the call by pressing and holding the **PTT** switch and speaking into the transceiver as you would during a normal call. After the call is finished, press the key programmed as **[Clear]** to end the call.

■ Receiving Group Calls (NXDN)

When you receive a group call on a Conventional channel and the received group ID matches the ID set up on your transceiver, you can hear the caller's voice.

When on a Trunking channel, if the Group ID of a received call matches your Group ID, you will hear the call.

■ Receiving Individual Calls (NXDN)

When you receive an individual call on a Conventional channel, a ringing tone will sound and the display will show the caller's ID. To respond to the call, press and hold the **PTT** switch and speak into the transceiver as you would during a normal call.

When you receive an individual call on a Trunking channel, a ringing tone will sound and the caller's ID and "Individual" appear on the display. After receiving the call, you can respond to the call by pressing and holding the **PTT** switch and speaking into the transceiver as you would during a normal call.

■ Receiving Group Calls (DMR)

When you receive a group call on a Conventional channel and the received group ID matches the ID set up on your transceiver, you can hear the caller's voice.

■ Receiving Individual Calls (DMR)

When you receive an individual call on a Conventional channel, a ringing tone will sound and the display will show the caller's ID. To respond to the call, press and hold the **PTT** switch and speak into the transceiver as you would during a normal call.

PROGRAMMABLE FUNCTIONS

Refer to the tables in this section to determine which functions are available for appropriate channels. Function descriptions start on page 27. Please contact your dealer for further details on these functions.

MENU MODE

Many functions on this transceiver are selected or configured through the Menu instead of physical controls. Once you become familiar with the Menu system, you will appreciate the versatility it offers.

Some transceiver keys may already be programmed with functions listed in the Menu. Those functions can be accessed directly by pressing the key. All other functions can still be accessed using the transceiver Menu. Refer to “FUNCTION LIST” {p. 17} for the available Menu items.

■ MENU ACCESS

- 1 Press the key programmed as **[Menu]**.
 - The category list is shown.
 - When there is only one category, the function list is shown (proceed to step 4).



- 2 Press **[▲]/[▼]/[◀]/[▶]** to select a category item.
 - On an optional microphone with keypad, you can enter a category number directly.

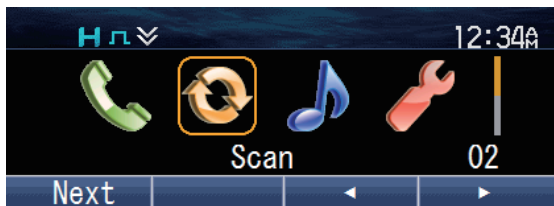
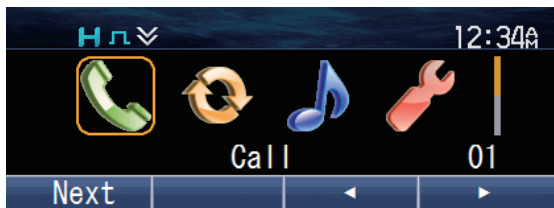

- 3 Press the [] key to view the function list.

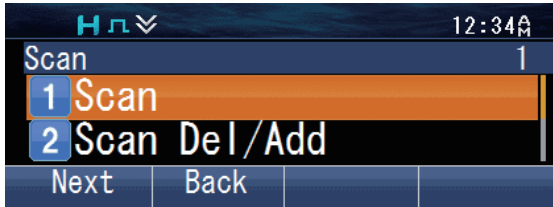

- 4 Press [▲]/[▼] to select a function item.
- On an optional microphone with keypad, you can enter a function number directly.

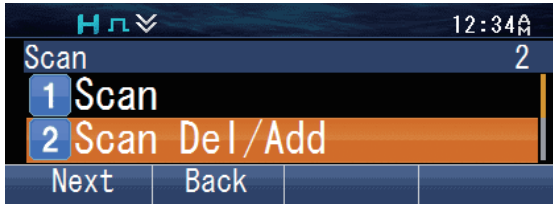

- 5 Press the [] key to set up the selected function item.
- Press the [] key to return to the category list.
- 6 Press [▲]/[▼] to select your desired setting.
- For settings with more than one level, repeat steps 5 and 6.
- 7 Press the [] key to set the selected setting and exit Menu mode.
- Press the [] key at any time to return to the previous display.
 - Press the [] key at any time to exit Menu mode.

KEY MODE

Your transceiver operations vary according to the functions that your dealer has programmed onto the transceiver keys. Refer to “FUNCTION LIST” {p. 17} for the available programmable functions.

FUNCTION LIST

PF Key: Functions that can be programmed to the transceiver keys

Menu: Functions that can be accessed using the transceiver Menu

Analog Conv.: Channels set up for Analog Conventional Operation

NXDN Conv.: Channels set up for NXDN Conventional Operation

P25 Conv.: Channels set up for P25 Conventional Operation

DMR Conv.: Channels set up for DMR Conventional Operation

LTR Trunking: Channels set up for LTR Trunking Operation

NXDN Trunking: Channels set up for NXDN Trunking Operation

P25 Trunking: Channels set up for P25 Trunking Operation

✓: Available

N/A: Not Available

■ Conventional Operation

| Function | Menu Display | PF Key | Menu | Analog Conv. | NXDN Conv. | P25 Conv. | DMR Conv. |
|-----------------------------------|----------------|--------|------|--------------|------------|-----------|-----------|
| None | - | ✓ | N/A | ✓ | ✓ | ✓ | ✓ |
| 2-tone | 2-tone | ✓ | ✓ | ✓ | ✓ | ✓ | N/A |
| ANR Preset | ANR Preset | N/A | ✓ | ✓ | ✓ | ✓ | ✓ |
| Audio Profile | Audio Profile | N/A | ✓ | ✓ | ✓ | ✓ | ✓ |
| Auto Dimmer *1 | Auto Dimmer | N/A | ✓ | ✓ | ✓ | ✓ | ✓ |
| Auto Telephone | Auto Telephone | ✓ | ✓ | N/A | N/A | N/A | N/A |
| Autodial | Auto Dial | ✓ | ✓ | ✓ | ✓ | N/A | N/A |
| Autodial Programming | Auto Dial Prog | ✓ | ✓ | ✓ | ✓ | ✓ | ✓ |
| AUX A | AUX A | ✓ | ✓ | ✓ | ✓ | ✓ | ✓ |
| AUX B | AUX B | ✓ | ✓ | ✓ | ✓ | ✓ | ✓ |
| AUX C | AUX C | ✓ | ✓ | ✓ | ✓ | ✓ | ✓ |
| AUX Output ID 1 | - | ✓ | N/A | ✓ | ✓ | ✓ | ✓ |
| AUX Output ID 2 | - | ✓ | N/A | ✓ | ✓ | ✓ | ✓ |
| AUX Output ID 3 | - | ✓ | N/A | ✓ | ✓ | ✓ | ✓ |
| Bluetooth | Bluetooth | ✓ | ✓ | ✓ | ✓ | ✓ | ✓ |
| Bluetooth Connect/ Disconnect | - | ✓ | N/A | ✓ | ✓ | ✓ | ✓ |
| Bluetooth Device | BT Device | N/A | ✓ | ✓ | ✓ | ✓ | ✓ |
| Bluetooth Discoverable | Discoverable | N/A | ✓ | ✓ | ✓ | ✓ | ✓ |
| Bluetooth Headset Connection Type | BT Headset Typ | N/A | ✓ | ✓ | ✓ | ✓ | ✓ |
| Bluetooth Information | Bluetooth Info | N/A | ✓ | ✓ | ✓ | ✓ | ✓ |
| Bluetooth Speaker | BT Speaker | ✓ | ✓ | ✓ | ✓ | ✓ | ✓ |
| Broadcast | Broadcast | ✓ | ✓ | N/A | N/A | N/A | ✓ |
| Call 1 ~ 6 | - | ✓ | N/A | ✓ | ✓ | ✓ | ✓ |
| Call Interruption | - | ✓ | N/A | N/A | N/A | N/A | ✓ |
| Call Response | - | ✓ | N/A | ✓ | ✓ | N/A | N/A |

| Function | Menu Display | PF Key | Menu | Analog Conv. | NXDN Conv. | P25 Conv. | DMR Conv. |
|-------------------------------|--------------------------------------|--------|------|--------------|------------|-----------|-----------|
| Channel Down | - | ✓ | N/A | ✓ | ✓ | ✓ | ✓ |
| Channel Entry | - | ✓ | N/A | ✓ | ✓ | ✓ | ✓ |
| Channel Information | - | ✓ | N/A | ✓ | ✓ | N/A | N/A |
| Channel Recall | - | ✓ | N/A | ✓ | ✓ | ✓ | ✓ |
| Channel Up | - | ✓ | N/A | ✓ | ✓ | ✓ | ✓ |
| Clear | - | ✓ | N/A | ✓ | ✓ | ✓ | ✓ |
| Clock | Clock | ✓ | ✓ | ✓ | ✓ | ✓ | ✓ |
| Clock Adjustment | Clock Adjust | ✓ | ✓ | ✓ | ✓ | ✓ | ✓ |
| Color Scheme | Color Scheme | N/A | ✓ | ✓ | ✓ | ✓ | ✓ |
| CW Message | - | ✓ | N/A | N/A | ✓ | N/A | N/A |
| Direct Channel 1 ~ 5 | - | ✓ | N/A | ✓ | ✓ | ✓ | ✓ |
| Direct Channel 1 ~ 5 Select | Direct Ch 1 Sel ~ Direct Ch 5 Sel | ✓ | ✓ | ✓ | ✓ | ✓ | ✓ |
| Display Format | Display Format | ✓ | ✓ | ✓ | ✓ | ✓ | ✓ |
| Eject SD Card | Eject Card | ✓ | ✓ | ✓ | ✓ | ✓ | ✓ |
| Emergency *2 | - | ✓ | N/A | ✓ | ✓ | ✓ | ✓ |
| External Mic Sense | Ext Mic Sense | N/A | ✓ | ✓ | ✓ | ✓ | ✓ |
| External Speaker | External SP | ✓ | ✓ | ✓ | ✓ | ✓ | ✓ |
| Fixed Volume | Fixed Volume | ✓ | ✓ | ✓ | ✓ | ✓ | ✓ |
| Format SD Card | Format Card | ✓ | ✓ | ✓ | ✓ | ✓ | ✓ |
| Front Panel Programming | Panel Program | ✓ | ✓ | ✓ | ✓ | ✓ | ✓ |
| Function | - | ✓ | N/A | ✓ | ✓ | ✓ | ✓ |
| GPS | GPS | ✓ | ✓ | ✓ | ✓ | ✓ | ✓ |
| GPS/ Bluetooth Reset | GPS/BT Reset | N/A | ✓ | ✓ | ✓ | ✓ | ✓ |
| GPS Position Display | GPS Pos Disp | ✓ | ✓ | ✓ | ✓ | ✓ | ✓ |
| Group *3 | Group | ✓ | ✓ | ✓ | ✓ | ✓ | ✓ |
| Group + Short Message *3 | Group+SDM | ✓ | ✓ | ✓ | ✓ | ✓ | ✓ |
| Group + Status *3 | Group+Status | ✓ | ✓ | ✓ | ✓ | ✓ | ✓ |
| Group ID/ Channel Entry | - | ✓ | N/A | ✓ | ✓ | ✓ | ✓ |
| High Transmit Power | High TX Power | ✓ | ✓ | ✓ | ✓ | ✓ | ✓ |
| Home Channel | - | ✓ | N/A | ✓ | ✓ | ✓ | ✓ |
| Home Channel Select | Home Ch Sel | ✓ | ✓ | ✓ | ✓ | ✓ | ✓ |
| Horn Alert | Horn Alert | ✓ | ✓ | ✓ | ✓ | ✓ | ✓ |
| Individual *3 | Individual | ✓ | ✓ | ✓ | ✓ | ✓ | ✓ |
| Individual + Short Message *3 | Indiv+SDM | ✓ | ✓ | ✓ | ✓ | ✓ | ✓ |
| Individual + Status *3 | Indiv+Status | ✓ | ✓ | ✓ | ✓ | ✓ | ✓ |
| Intercom | Intercom | ✓ | ✓ | ✓ | ✓ | ✓ | ✓ |
| IP Address | IP Address | N/A | ✓ | N/A | N/A | N/A | N/A |

| Function | Menu Display | PF Key | Menu | Analog Conv. | NXDN Conv. | P25 Conv. | DMR Conv. |
|---------------------------|----------------|--------|------|--------------|------------|-----------|-----------|
| Key Delete | Key Delete | ✓ | ✓ | ✓ | ✓ | ✓ | ✓ |
| Key Lock | - | ✓ | N/A | ✓ | ✓ | ✓ | ✓ |
| Keypad *4 | Keypad | ✓ | ✓ | N/A | N/A | ✓ | N/A |
| Language | Language | N/A | ✓ | ✓ | ✓ | ✓ | ✓ |
| LCD Brightness | LCD Brightness | ✓ | ✓ | ✓ | ✓ | ✓ | ✓ |
| Lone Worker | Lone Worker | ✓ | ✓ | ✓ | ✓ | ✓ | ✓ |
| Low Transmit Power | Low TX Power | ✓ | ✓ | ✓ | ✓ | ✓ | ✓ |
| Maintenance | Maintenance | ✓ | ✓ | ✓ | ✓ | ✓ | ✓ |
| Manual Site Hunt | Manual Hunt | ✓ | ✓ | N/A | N/A | N/A | ✓ |
| Master Volume Control | Master Volume | ✓ | ✓ | ✓ | ✓ | ✓ | ✓ |
| Medium Transmit Power | Med TX Power | N/A | ✓ | ✓ | ✓ | ✓ | ✓ |
| Menu | - | ✓ | N/A | ✓ | ✓ | ✓ | ✓ |
| Mobile Relay Station | - | ✓ | N/A | ✓ | ✓ | ✓ | N/A |
| Mic Sense | Mic Sense | N/A | ✓ | ✓ | ✓ | ✓ | ✓ |
| Microphone Type | Mic Type | N/A | ✓ | ✓ | ✓ | ✓ | ✓ |
| Monitor | Monitor | ✓ | ✓ | ✓ | ✓ | ✓ | ✓ |
| Monitor Momentary | - | ✓ | N/A | ✓ | ✓ | ✓ | ✓ |
| Multi RF Deck View | Multi View | ✓ | ✓ | ✓ | ✓ | ✓ | ✓ |
| Operator Selectable Tone | OST | ✓ | ✓ | ✓ | N/A | N/A | N/A |
| OST Down | - | ✓ | N/A | ✓ | N/A | N/A | N/A |
| OST List | OST List | ✓ | ✓ | ✓ | N/A | N/A | N/A |
| OST Up | - | ✓ | N/A | ✓ | N/A | N/A | N/A |
| OVCN | OVCN | ✓ | ✓ | N/A | N/A | N/A | ✓ |
| Playback | Playback | ✓ | ✓ | ✓ | ✓ | ✓ | ✓ |
| Playback (Last Recording) | - | ✓ | N/A | ✓ | ✓ | ✓ | ✓ |
| Priority-channel Select | Pri Ch Select | ✓ | ✓ | ✓ | ✓ | ✓ | ✓ |
| Public Address | Public Address | ✓ | ✓ | ✓ | ✓ | ✓ | ✓ |
| Radio Check | Radio Check | N/A | ✓ | ✓ | N/A | N/A | N/A |
| Radio Inhibit | Inhibit | N/A | ✓ | ✓ | N/A | N/A | N/A |
| Radio Uninhibit | Uninhibit | N/A | ✓ | ✓ | N/A | N/A | N/A |
| Regroup Request | Regroup Req | ✓ | ✓ | N/A | N/A | N/A | N/A |
| Rekey Request *4 | Rekey Request | ✓ | ✓ | N/A | N/A | ✓ | N/A |
| Remote Control | Remote Control | ✓ | ✓ | N/A | ✓ | N/A | ✓ |
| RF Deck 1 | - | ✓ | N/A | ✓ | ✓ | ✓ | ✓ |
| RF Deck 2 | - | ✓ | N/A | ✓ | ✓ | ✓ | ✓ |
| RF Deck 3 | - | ✓ | N/A | ✓ | ✓ | ✓ | ✓ |
| RF Deck Down | - | ✓ | N/A | ✓ | ✓ | ✓ | ✓ |
| RF Deck Select | RF Deck Select | ✓ | ✓ | ✓ | ✓ | ✓ | ✓ |
| RF Deck Up | - | ✓ | N/A | ✓ | ✓ | ✓ | ✓ |

| Function | Menu Display | PF Key | Menu | Analog Conv. | NXDN Conv. | P25 Conv. | DMR Conv. |
|------------------------------------|----------------|--------|------|--------------|------------|-----------|-----------|
| RX Audio Equalizer (High) | RX EQ High | N/A | ✓ | ✓ | ✓ | ✓ | ✓ |
| RX Audio Equalizer (High Midrange) | RX EQ High Mid | N/A | ✓ | ✓ | ✓ | ✓ | ✓ |
| RX Audio Equalizer (Midrange) | RX EQ Midrange | N/A | ✓ | ✓ | ✓ | ✓ | ✓ |
| RX Audio Equalizer (Low Midrange) | RX EQ Low Mid | N/A | ✓ | ✓ | ✓ | ✓ | ✓ |
| RX Audio Equalizer (Low) | RX EQ Low | N/A | ✓ | ✓ | ✓ | ✓ | ✓ |
| RX Auto Gain Control | RX AGC | N/A | ✓ | ✓ | ✓ | ✓ | ✓ |
| Save GPS Data | Save GPS Data | ✓ | ✓ | ✓ | ✓ | ✓ | ✓ |
| Save Log Data | Save Log Data | ✓ | ✓ | ✓ | ✓ | ✓ | ✓ |
| Scan | Scan | ✓ | ✓ | ✓ | ✓ | ✓ | ✓ |
| Scan Delete/ Add | Scan Del/Add | ✓ | ✓ | ✓ | ✓ | ✓ | ✓ |
| Scan Normal | Scan Normal | ✓ | ✓ | ✓ | ✓ | ✓ | ✓ |
| Scan Program | Scan Program | ✓ | ✓ | ✓ | ✓ | ✓ | ✓ |
| Scrambler/ Encryption | Scram/Encryp | ✓ | ✓ | ✓ | ✓ | ✓ | ✓ |
| Scrambler/ Encryption Code | Scram/Enc Code | ✓ | ✓ | ✓ | ✓ | ✓ | ✓ |
| Send the GPS Data | Send GPS Data | ✓ | ✓ | ✓ | ✓ | ✓ | ✓ |
| Short Message | Short Message | ✓ | ✓ | ✓ | ✓ | N/A | ✓ |
| Site Down | - | ✓ | N/A | N/A | N/A | N/A | N/A |
| Site Lock | Site Lock | ✓ | ✓ | N/A | N/A | N/A | N/A |
| Site Number | Site No. | N/A | ✓ | N/A | N/A | N/A | N/A |
| Site Select | Site | ✓ | ✓ | N/A | N/A | N/A | N/A |
| Site Up | - | ✓ | N/A | N/A | N/A | N/A | N/A |
| Speaker 1-2 Mute | Speaker1-2Mute | ✓ | ✓ | ✓ | ✓ | ✓ | ✓ |
| Speaker Attenuation | - | ✓ | N/A | ✓ | ✓ | ✓ | ✓ |
| Speaker Type | Speaker Type | N/A | ✓ | ✓ | ✓ | ✓ | ✓ |
| Squelch Level | Squelch Level | ✓ | ✓ | ✓ | N/A | N/A | N/A |
| Squelch Off | Squelch Off | ✓ | ✓ | ✓ | ✓ | ✓ | ✓ |
| Squelch Off Momentary | - | ✓ | N/A | ✓ | ✓ | ✓ | ✓ |
| Stack | Stack | ✓ | ✓ | ✓ | ✓ | ✓ | ✓ |
| Status | Status | ✓ | ✓ | ✓ | ✓ | N/A | ✓ |
| Surveillance | Surveillance | ✓ | ✓ | ✓ | ✓ | ✓ | ✓ |
| System Down | - | ✓ | N/A | N/A | N/A | N/A | N/A |
| System Lock | System Lock | ✓ | ✓ | N/A | N/A | N/A | N/A |
| System Search | System Search | ✓ | ✓ | N/A | N/A | N/A | N/A |
| System Select | System | ✓ | ✓ | N/A | N/A | N/A | N/A |
| System Up | - | ✓ | N/A | N/A | N/A | N/A | N/A |

| Function | Menu Display | PF Key | Menu | Analog Conv. | NXDN Conv. | P25 Conv. | DMR Conv. |
|------------------------------------|----------------|--------|------|--------------|------------|-----------|-----------|
| Tactical Zone | - | ✓ | N/A | ✓ | N/A | ✓ | N/A |
| Talk Around | Talk Around | ✓ | ✓ | ✓ | ✓ | ✓ | ✓ |
| Talkgroup Reset | Talkgroup Rst | ✓ | ✓ | N/A | N/A | ✓ | N/A |
| Task Request Confirmation | Task | ✓ | ✓ | N/A | ✓ | N/A | ✓ |
| Telephone Disconnect | - | ✓ | N/A | N/A | N/A | N/A | N/A |
| Transceiver Password | Password | ✓ | ✓ | ✓ | ✓ | ✓ | ✓ |
| TX Audio Equalizer (High) | TX EQ High | N/A | ✓ | ✓ | ✓ | ✓ | ✓ |
| TX Audio Equalizer (High Midrange) | TX EQ High Mid | N/A | ✓ | ✓ | ✓ | ✓ | ✓ |
| TX Audio Equalizer (Midrange) | TX EQ Midrange | N/A | ✓ | ✓ | ✓ | ✓ | ✓ |
| TX Audio Equalizer (Low Midrange) | TX EQ Low Mid | N/A | ✓ | ✓ | ✓ | ✓ | ✓ |
| TX Audio Equalizer (Low) | TX EQ Low | N/A | ✓ | ✓ | ✓ | ✓ | ✓ |
| TX Auto Gain Control | TX AGC | N/A | ✓ | ✓ | ✓ | ✓ | ✓ |
| Unselected RF Deck Speaker | Unsel Deck SP | ✓ | ✓ | ✓ | ✓ | ✓ | ✓ |
| Unselected Speaker Offset | Unsel Deck Vol | N/A | ✓ | ✓ | ✓ | ✓ | ✓ |
| Voice Memo | Voice Memo | ✓ | ✓ | ✓ | ✓ | ✓ | ✓ |
| Volume Down | - | ✓ | N/A | ✓ | ✓ | ✓ | ✓ |
| Volume Up | - | ✓ | N/A | ✓ | ✓ | ✓ | ✓ |
| VOX | VOX Level | ✓ | ✓ | ✓ | ✓ | ✓ | ✓ |
| VOX Function | VOX | ✓ | ✓ | ✓ | ✓ | ✓ | ✓ |
| Zeroize | Zeroize | ✓ | ✓ | ✓ | ✓ | ✓ | ✓ |
| Zone Delete/ Add | Zone Del/ Add | ✓ | ✓ | ✓ | ✓ | ✓ | ✓ |
| Zone Down | - | ✓ | N/A | ✓ | ✓ | ✓ | ✓ |
| Zone Up | - | ✓ | N/A | ✓ | ✓ | ✓ | ✓ |

■ Trunking Operation

| Function | Menu Display | PF Key | Menu | LTR Trunking | NXDN Trunking | P25 Trunking |
|----------------------|----------------|--------|------|--------------|---------------|--------------|
| None | - | ✓ | N/A | ✓ | ✓ | ✓ |
| 2-tone | 2-tone | ✓ | ✓ | N/A | ✓ | ✓ |
| ANR Preset | ANR Preset | N/A | ✓ | ✓ | ✓ | ✓ |
| Audio Profile | Audio Profile | N/A | ✓ | ✓ | ✓ | ✓ |
| Auto Dimmer *1 | Auto Dimmer | N/A | ✓ | ✓ | ✓ | ✓ |
| Auto Telephone | Auto Telephone | ✓ | ✓ | ✓ | N/A | N/A |
| Autodial | Auto Dial | ✓ | ✓ | ✓ | ✓ | ✓ |
| Autodial Programming | Auto Dial Prog | ✓ | ✓ | ✓ | ✓ | ✓ |

| Function | Menu Display | PF Key | Menu | LTR Trunking | NXDN Trunking | P25 Trunking |
|-----------------------------------|--------------------------------------|--------|------|--------------|---------------|--------------|
| AUX A | AUX A | ✓ | ✓ | ✓ | ✓ | ✓ |
| AUX B | AUX B | ✓ | ✓ | ✓ | ✓ | ✓ |
| AUX C | AUX C | ✓ | ✓ | ✓ | ✓ | ✓ |
| AUX Output ID 1 | - | ✓ | N/A | ✓ | ✓ | ✓ |
| AUX Output ID 2 | - | ✓ | N/A | ✓ | ✓ | ✓ |
| AUX Output ID 3 | - | ✓ | N/A | ✓ | ✓ | ✓ |
| Bluetooth | Bluetooth | ✓ | ✓ | ✓ | ✓ | ✓ |
| Bluetooth Connect/ Disconnect | - | ✓ | N/A | ✓ | ✓ | ✓ |
| Bluetooth Device | BT Device | N/A | ✓ | ✓ | ✓ | ✓ |
| Bluetooth Discoverable | Discoverable | N/A | ✓ | ✓ | ✓ | ✓ |
| Bluetooth Headset Connection Type | BT Headset Typ | N/A | ✓ | ✓ | ✓ | ✓ |
| Bluetooth Information | Bluetooth Info | N/A | ✓ | ✓ | ✓ | ✓ |
| Bluetooth Speaker | BT Speaker | ✓ | ✓ | ✓ | ✓ | ✓ |
| Broadcast | Broadcast | ✓ | ✓ | N/A | ✓ | N/A |
| Call 1 ~ 6 | - | ✓ | N/A | ✓ | ✓ | N/A |
| Call Interruption | - | ✓ | N/A | N/A | N/A | N/A |
| Call Response | - | ✓ | N/A | N/A | ✓ | ✓ |
| Channel Down | - | ✓ | N/A | ✓ | ✓ | ✓ |
| Channel Entry | - | ✓ | N/A | ✓ | ✓ | ✓ |
| Channel Information | - | ✓ | N/A | N/A | N/A | N/A |
| Channel Recall | - | ✓ | N/A | ✓ | ✓ | ✓ |
| Channel Up | - | ✓ | N/A | ✓ | ✓ | ✓ |
| Clear | - | ✓ | N/A | ✓ | ✓ | ✓ |
| Clock | Clock | ✓ | ✓ | ✓ | ✓ | ✓ |
| Clock Adjustment | Clock Adjust | ✓ | ✓ | ✓ | ✓ | ✓ |
| Color Scheme | Color Scheme | N/A | ✓ | ✓ | ✓ | ✓ |
| CW Message | - | ✓ | N/A | N/A | N/A | N/A |
| Direct Channel 1 ~ 5 | - | ✓ | N/A | ✓ | ✓ | ✓ |
| Direct Channel 1 ~ 5 Select | Direct Ch 1 Sel ~ Direct Ch 5 Sel | ✓ | ✓ | ✓ | ✓ | ✓ |
| Display Format | Display Format | ✓ | ✓ | ✓ | ✓ | ✓ |
| Eject SD Card | Eject Card | ✓ | ✓ | ✓ | ✓ | ✓ |
| Emergency *2 | - | ✓ | N/A | ✓ | ✓ | ✓ |
| External Mic Sense | Ext Mic Sense | N/A | ✓ | ✓ | ✓ | ✓ |
| External Speaker | External SP | ✓ | ✓ | ✓ | ✓ | ✓ |
| Fixed Volume | Fixed Volume | ✓ | ✓ | ✓ | ✓ | ✓ |
| Format SD Card | Format Card | ✓ | ✓ | ✓ | ✓ | ✓ |
| Front Panel Programming | Panel Program | ✓ | ✓ | N/A | N/A | N/A |

| Function | Menu Display | PF Key | Menu | LTR Trunking | NXDN Trunking | P25 Trunking |
|-------------------------------|----------------|--------|------|--------------|---------------|--------------|
| Function | - | ✓ | N/A | ✓ | ✓ | ✓ |
| GPS | GPS | ✓ | ✓ | ✓ | ✓ | ✓ |
| GPS/ Bluetooth Reset | GPS/BT Reset | N/A | ✓ | ✓ | ✓ | ✓ |
| GPS Position Display | GPS Pos Disp | ✓ | ✓ | ✓ | ✓ | ✓ |
| Group *3 | Group | ✓ | ✓ | ✓ | ✓ | N/A |
| Group + Short Message *3 | Group+SDM | ✓ | ✓ | ✓ | ✓ | N/A |
| Group + Status *3 | Group+Status | ✓ | ✓ | ✓ | ✓ | N/A |
| Group ID/ Channel Entry | - | ✓ | N/A | ✓ | ✓ | ✓ |
| High Transmit Power | High TX Power | ✓ | ✓ | ✓ | ✓ | ✓ |
| Home Channel | - | ✓ | N/A | ✓ | ✓ | ✓ |
| Home Channel Select | Home Ch Sel | ✓ | ✓ | ✓ | ✓ | ✓ |
| Horn Alert | Horn Alert | ✓ | ✓ | ✓ | ✓ | ✓ |
| Individual *3 | Individual | ✓ | ✓ | ✓ | ✓ | ✓ |
| Individual + Short Message *3 | Indiv+SDM | ✓ | ✓ | ✓ | ✓ | ✓ |
| Individual + Status *3 | Indiv+Status | ✓ | ✓ | ✓ | ✓ | ✓ |
| Intercom | Intercom | ✓ | ✓ | ✓ | ✓ | ✓ |
| IP Address | IP Address | N/A | ✓ | N/A | N/A | ✓ |
| Key Delete | Key Delete | ✓ | ✓ | ✓ | ✓ | ✓ |
| Key Lock | - | ✓ | N/A | ✓ | ✓ | ✓ |
| Keypad *4 | Keypad | ✓ | ✓ | N/A | N/A | ✓ |
| Language | Language | N/A | ✓ | ✓ | ✓ | ✓ |
| LCD Brightness | LCD Brightness | ✓ | ✓ | ✓ | ✓ | ✓ |
| Lone Worker | Lone Worker | ✓ | ✓ | ✓ | ✓ | ✓ |
| Low Transmit Power | Low TX Power | ✓ | ✓ | ✓ | ✓ | ✓ |
| Maintenance | Maintenance | ✓ | ✓ | ✓ | ✓ | ✓ |
| Manual Site Hunt | Manual Hunt | ✓ | ✓ | N/A | N/A | N/A |
| Master Volume Control | Master Volume | ✓ | ✓ | ✓ | ✓ | ✓ |
| Medium Transmit Power | Med TX Power | N/A | ✓ | ✓ | ✓ | ✓ |
| Menu | - | ✓ | N/A | ✓ | ✓ | ✓ |
| Mobile Relay Station | - | ✓ | N/A | N/A | N/A | N/A |
| Mic Sense | Mic Sense | N/A | ✓ | ✓ | ✓ | ✓ |
| Microphone Type | Mic Type | N/A | ✓ | ✓ | ✓ | ✓ |
| Monitor | Monitor | ✓ | ✓ | ✓ | ✓ | ✓ |
| Monitor Momentary | - | ✓ | N/A | ✓ | ✓ | ✓ |
| Multi RF Deck View | Multi View | ✓ | ✓ | ✓ | ✓ | ✓ |
| Operator Selectable Tone | OST | ✓ | ✓ | N/A | N/A | N/A |
| OST Down | - | ✓ | N/A | N/A | N/A | N/A |
| OST List | OST List | ✓ | ✓ | N/A | N/A | N/A |

| Function | Menu Display | PF Key | Menu | LTR Trunking | NXDN Trunking | P25 Trunking |
|------------------------------------|----------------|--------|------|--------------|---------------|--------------|
| OST Up | - | ✓ | N/A | N/A | N/A | N/A |
| OVCN | OVCN | ✓ | ✓ | N/A | N/A | N/A |
| Playback | Playback | ✓ | ✓ | ✓ | ✓ | ✓ |
| Playback (Last Recording) | - | ✓ | N/A | ✓ | ✓ | ✓ |
| Priority-channel Select | Pri Ch Select | ✓ | ✓ | ✓ | N/A | ✓ |
| Public Address | Public Address | ✓ | ✓ | ✓ | ✓ | ✓ |
| Radio Check | Radio Check | N/A | ✓ | ✓ | N/A | N/A |
| Radio Inhibit | Inhibit | N/A | ✓ | ✓ | N/A | N/A |
| Radio Uninhibit | Uninhibit | N/A | ✓ | ✓ | N/A | N/A |
| Regroup Request | Regroup Req | ✓ | ✓ | N/A | N/A | ✓ |
| Rekey Request *4 | Rekey Request | ✓ | ✓ | N/A | N/A | ✓ |
| Remote Control | Remote Control | ✓ | ✓ | N/A | ✓ | N/A |
| RF Deck 1 | - | ✓ | N/A | ✓ | ✓ | ✓ |
| RF Deck 2 | - | ✓ | N/A | ✓ | ✓ | ✓ |
| RF Deck 3 | - | ✓ | N/A | ✓ | ✓ | ✓ |
| RF Deck Down | - | ✓ | N/A | ✓ | ✓ | ✓ |
| RF Deck Select | RF Deck Select | ✓ | ✓ | ✓ | ✓ | ✓ |
| RF Deck Up | - | ✓ | N/A | ✓ | ✓ | ✓ |
| RX Audio Equalizer (High) | RX EQ High | N/A | ✓ | ✓ | ✓ | ✓ |
| RX Audio Equalizer (High Midrange) | RX EQ High Mid | N/A | ✓ | ✓ | ✓ | ✓ |
| RX Audio Equalizer (Midrange) | RX EQ Midrange | N/A | ✓ | ✓ | ✓ | ✓ |
| RX Audio Equalizer (Low Midrange) | RX EQ Low Mid | N/A | ✓ | ✓ | ✓ | ✓ |
| RX Audio Equalizer (Low) | RX EQ Low | N/A | ✓ | ✓ | ✓ | ✓ |
| RX Auto Gain Control | RX AGC | N/A | ✓ | ✓ | ✓ | ✓ |
| Save GPS Data | Save GPS Data | ✓ | ✓ | ✓ | ✓ | ✓ |
| Save Log Data | Save Log Data | ✓ | ✓ | ✓ | ✓ | ✓ |
| Scan | Scan | ✓ | ✓ | ✓ | ✓ | ✓ |
| Scan Delete/ Add | Scan Del/Add | ✓ | ✓ | ✓ | ✓ | ✓ |
| Scan Normal | Scan Normal | ✓ | ✓ | ✓ | ✓ | ✓ |
| Scan Program | Scan Program | ✓ | ✓ | ✓ | ✓ | ✓ |
| Scrambler/ Encryption | Scram/Encryp | ✓ | ✓ | ✓ | ✓ | ✓ |
| Scrambler/ Encryption Code | Scram/Enc Code | ✓ | ✓ | ✓ | ✓ | ✓ |
| Send the GPS Data | Send GPS Data | ✓ | ✓ | ✓ | ✓ | ✓ |
| Short Message | Short Message | ✓ | ✓ | ✓ | ✓ | N/A |
| Site Down | - | ✓ | N/A | N/A | ✓ | N/A |
| Site Lock | Site Lock | ✓ | ✓ | N/A | ✓ | ✓ |

| Function | Menu Display | PF Key | Menu | LTR Trunking | NXDN Trunking | P25 Trunking |
|------------------------------------|----------------|--------|------|--------------|---------------|--------------|
| Site Number | Site No. | N/A | ✓ | N/A | ✓ | ✓ |
| Site Select | Site | ✓ | ✓ | N/A | ✓ | N/A |
| Site Up | - | ✓ | N/A | N/A | ✓ | N/A |
| Speaker 1-2 Mute | Speaker1-2Mute | ✓ | ✓ | ✓ | ✓ | ✓ |
| Speaker Attenuation | - | ✓ | N/A | ✓ | ✓ | ✓ |
| Speaker Type | Speaker Type | N/A | ✓ | ✓ | ✓ | ✓ |
| Squelch Level | Squelch Level | ✓ | ✓ | N/A | N/A | N/A |
| Squelch Off | Squelch Off | ✓ | ✓ | ✓ | ✓ | ✓ |
| Squelch Off Momentary | - | ✓ | N/A | ✓ | ✓ | ✓ |
| Stack | Stack | ✓ | ✓ | ✓ | ✓ | ✓ |
| Status | Status | ✓ | ✓ | ✓ | ✓ | ✓ |
| Surveillance | Surveillance | ✓ | ✓ | ✓ | ✓ | ✓ |
| System Down | - | ✓ | N/A | N/A | ✓ | N/A |
| System Lock | System Lock | ✓ | ✓ | N/A | ✓ | N/A |
| System Search | System Search | ✓ | ✓ | N/A | ✓ | ✓ |
| System Select | System | ✓ | ✓ | N/A | ✓ | N/A |
| System Up | - | ✓ | N/A | N/A | ✓ | N/A |
| Tactical Zone | - | ✓ | N/A | N/A | N/A | N/A |
| Talk Around | Talk Around | ✓ | ✓ | ✓ | N/A | N/A |
| Talkgroup Reset | Talkgroup Rst | ✓ | ✓ | N/A | N/A | N/A |
| Task Request Confirmation | Task | ✓ | ✓ | N/A | ✓ | N/A |
| Telephone Disconnect | - | ✓ | N/A | ✓ | N/A | N/A |
| Transceiver Password | Password | ✓ | ✓ | ✓ | ✓ | ✓ |
| TX Audio Equalizer (High) | TX EQ High | N/A | ✓ | ✓ | ✓ | ✓ |
| TX Audio Equalizer (High Midrange) | TX EQ High Mid | N/A | ✓ | ✓ | ✓ | ✓ |
| TX Audio Equalizer (Midrange) | TX EQ Midrange | N/A | ✓ | ✓ | ✓ | ✓ |
| TX Audio Equalizer (Low Midrange) | TX EQ Low Mid | N/A | ✓ | ✓ | ✓ | ✓ |
| TX Audio Equalizer (Low) | TX EQ Low | N/A | ✓ | ✓ | ✓ | ✓ |
| TX Auto Gain Control | TX AGC | N/A | ✓ | ✓ | ✓ | ✓ |
| Unselected RF Deck Speaker | Unsel Deck SP | ✓ | ✓ | ✓ | ✓ | ✓ |
| Unselected Speaker Offset | Unsel Deck Vol | N/A | ✓ | ✓ | ✓ | ✓ |
| Voice Memo | Voice Memo | ✓ | ✓ | ✓ | ✓ | ✓ |
| Volume Down | - | ✓ | N/A | ✓ | ✓ | ✓ |
| Volume Up | - | ✓ | N/A | ✓ | ✓ | ✓ |
| VOX | VOX Level | ✓ | ✓ | ✓ | ✓ | ✓ |
| VOX Function | VOX | ✓ | ✓ | ✓ | ✓ | ✓ |

| Function | Menu Display | PF Key | Menu | LTR Trunking | NXDN Trunking | P25 Trunking |
|------------------|---------------|--------|------|--------------|---------------|--------------|
| Zeroize | Zeroize | ✓ | ✓ | ✓ | ✓ | ✓ |
| Zone Delete/ Add | Zone Del/ Add | ✓ | ✓ | ✓ | N/A | N/A |
| Zone Down | - | ✓ | N/A | ✓ | ✓ | ✓ |
| Zone Up | - | ✓ | N/A | ✓ | ✓ | ✓ |

- *1 Auto Dimmer is not available on the KCH-21R Handheld Control Head.
- *2 Emergency can be programmed only on the Auxiliary (orange) key.
- *3 Group, Group + Short Message, Group + Status, Individual, Individual + Short Message and Individual + Status function as Selcall in FleetSync systems.
- *4 Keyset and Rekey Request can be used when set as P25 OTAR.

CHARACTER ENTRY

While in the character entry screen, you can use the following two methods to enter the characters:

■ Pressing the [▲]/[▼] keys

Press [▲]/[▼] to cycle the characters from A ~ Z, a ~ z, 0 ~ 9, and a space (default settings).

You can also assign a character to an optional key and later press that key to recall the assigned character: A ~ Z, a ~ z, 0 ~ 9, or a space and characters.

- You can enter characters using the [▲]/[▼] keys when the keys function as character input keys. When the keys function as line up/ down keys, it is not possible to enter a character.

■ Using the keypad (Optional microphone with keypad only)

Press the keypad keys to enter characters as shown in the table below.

You can press the [○] key repeatedly to switch the input mode (upper case → lower case → numbers → back to beginning).

| Keypad | Character Cycle (Upper Case) | Character Cycle (Lower Case) |
|--------|------------------------------|------------------------------|
| 1 | @ # " () ! \$ _ | @ # " () ! \$ _ |
| 2 | A B C | a b c |
| 3 | D E F | d e f |
| 4 | G H I | g h i |
| 5 | J K L | j k l |
| 6 | M N O | m n o |
| 7 | P Q R S | p q r s |
| 8 | T U V | t u v |
| 9 | W X Y Z | w x y z |
| 0 | (space) . , ? / ' & | (space) . , ? / ' & |

FUNCTIONS OVERVIEW

Following is a brief overview of the functions available on the transceiver accessible using the Menu and/or programmable to the transceiver keys.

For details on functions that are not included in “FUNCTION DETAILS” {p. 40} , please contact your dealer.

- Texts in the < > brackets are the displays for the key guides.

■ None

No function has been programmed.

■ 2-tone <2-tone>

Allows you to quickly call the 2-tone list that have been programmed onto your transceiver.

■ ANR Preset

Cancels the background noise to improve the audio quality during transmission.

■ Audio Profile

Allows you to select a preferred preset profile that suits the operating environment and operating condition of the transceiver.

■ Auto Dimmer

Adjusts the display brightness automatically depending on the surrounding lighting conditions.

■ Auto Telephone <AtTel>

Automatically searches and connects to a telephone repeater that can be connected in LTR Trunking system.

■ Autodial <AtDial>

Allows you to quickly call telephone numbers that have been programmed onto your transceiver. Refer to “Autodial” {p. 44} .

■ Autodial Programming <DialPg>

Allows you to edit the Autodial list.

■ AUX A <AUX_A>

Toggles the auxiliary port A ON and OFF. When toggled on, the optional feature connected to the auxiliary port A will be activated and the  indicator will appear on the display.

■ AUX B <AUX_B>

Toggles the auxiliary port B ON and OFF. When toggled on, the optional feature connected to the auxiliary port B will be activated and the  indicator will appear on the display.

■ **AUX C <AUX_C>**

Toggles the auxiliary port C ON and OFF. When toggled on, the optional feature connected to the auxiliary port C will be activated and the  indicator will appear on the display.

■ **AUX Output ID 1 ~ 3 <AUX 1 ~ AUX 3>**

Toggles the auxiliary output ID port ON and OFF. When toggled on, the optional feature connected to the auxiliary port will be activated and the ID name will appear on the display.

■ **Bluetooth <Btooth>**

Enables or disables the Bluetooth function. Refer to “Bluetooth” {p. 63} .

■ **Bluetooth Connect/ Disconnect <BtConn/ BtDisc>**

Press this key to pair with the selected Bluetooth device when a Bluetooth device is not connected. When a Bluetooth device is connected, press this key to disconnect the Bluetooth device.

■ **Bluetooth Device**

Activates Bluetooth Device mode.

■ **Bluetooth Discoverable**

Allows the transceiver to respond to the search for Bluetooth-enabled devices.

■ **Bluetooth Headset Connection Type**

Allows you to select the type of Bluetooth headset to be connected to the transceiver via HSP connection.

■ **Bluetooth Information**

Allows you to display the Bluetooth device name of the transceiver.

■ **Bluetooth Speaker <BtSpkr>**

Allows you to switch the speaker from the transceiver’s built-in speaker to the speaker of a connected Bluetooth device.

■ **Broadcast <B.Cast>**

Allows you to make a Broadcast Group Call. Switches between Broadcast Group Call and Conference Group Call when Broadcast Group Call is enabled.

■ **Call 1 ~ 6 <Call1 ~ Call6>**

Press this key to send a message or initiate a call.

■ **Call Interruption <Intrpt>**

Allows a transceiver other than the transmitting transceiver to terminate voice communications by sending and receiving a Call Interruption request message. If a transceiver receives a Call Interruption request message on the channel where the transceiver is performing voice communications, the transceiver terminates the voice communications.

■ Call Response <CalRes>

Press this key to respond to an Individual Call. When an Individual Call is received, the Alert tone stops.

■ Channel Down <CH->

Press this key to decrease the channel number. {p. 5}

■ Channel Entry <CH_Ent>

Press this key to enter Channel Entry Mode, to select a channel.

■ Channel Information <ChInfo>

Allows you to cycle through the display information as follows: Channel name > Zone-channel number > Frequency > QT/DQT > RAN

■ Channel Recall <CH_Rcl>

Press this key during Scan to return to the last called zone and channel.

■ Channel Up <CH+>

Press this key to increase the channel number. {p. 5}

■ Clear <Clear>

Press this key to end a call or cancel a data transmission.

■ Clock <Clock>

Refer to "CLOCK" {p. 51} .

■ Clock Adjustment <ClkAdj>

Allows you to set the clock. Refer to "CLOCK" {p. 51} .

■ Color Scheme

Allows you to change the color scheme of the LCD. Refer to "COLOR SCHEME" {p. 52} .

■ CW Message <CW_Msg>

Press this key to send the CW message.

■ Direct Channel 1 ~ 5 <DR1 ~ DR5>

Press one of these keys to jump to a frequently used zone and channel (pre-programmed by your dealer). If activated by your dealer, you can set your own Direct Channels by selecting your desired zone and channel using Direct Channel 1 ~ 5 Select.

■ Direct Channel 1 ~ 5 Select

Allows you to set the currently selected zone and channel as the Direct Channel 1 ~ 5.

■ Display Format <Disp>

Allows you to switch the display between the zone-channel number and the channel name.

■ Eject SD Card <Eject>

Allows you to eject the microSD card.

■ Emergency

Refer to “EMERGENCY CALLS” {p. 46}.

■ External Mic Sense

Activates External Mic Sense mode.

■ External Speaker <Spkr>

Switches the speaker from the transceiver’s built-in speaker to an optional external speaker.

■ Fixed Volume <FixVol>

Allows you to change the volume level of the tone.

■ Format SD Card <Format>

Allows you to format the microSD card.

■ Front Panel Programming <FPP>

Activates Front Panel Programming mode. This mode allows you to change the frequency and other data of a Conventional channel and to add new Conventional channels using your transceiver even when the FPU (Field Programming Unit) software or a computer is not available.

■ Function <Func>

Press this key, then press a programmable key to activate its secondary function.

■ GPS <GPS>

Enables or disables the GPS function.

■ GPS/ Bluetooth Reset

Activates GPS/ Bluetooth Reset mode.

■ GPS Position Display <GPS_P>

Allows you to display your location data. Location data that is saved on the microSD card using the Save GPS Data function or in GPS Position Display mode can be displayed.

■ Group <Group>

Activates Group Call Mode.

■ Group + Short Message <Grp+SD>

Allows you to specify a Group ID to send short messages.

■ **Group + Status <Grp+ST>**

Allows you to specify a Group ID to send status messages.

■ **Group ID/ Channel Entry <GrpEnt>**

In NXDN Trunking systems, press this key to enter a Group ID. In other operating systems, this key functions the same as Channel Entry.

■ **High Transmit Power <High>**

Turns High Transmit Power on or off. When using a channel programmed with low or medium power, this allows you to change the output power to high.

■ **Home Channel <Home>**

Press this key to jump to your home zone and channel (pre-programmed by your dealer). If activated by your dealer, you can set your own Home Channel by selecting your desired zone and channel using Home Channel Select.

■ **Home Channel Select**

Allows you to set the currently selected channel to Home Channel.

■ **Horn Alert <HA>**

Enables the Horn Alert terminal when a call is received. It activates the car headlights and horn to alert you of the incoming call when you are away from the transceiver.

■ **Individual <Indcal>**

Refer to “Making Individual Calls” {p. 7} {p. 9} {p. 11} {p. 12} .

■ **Individual + Short Message <Ind+SD>**

Allows you to specify a Unit ID to send short messages.

■ **Individual + Status <Ind+ST>**

Allows you to specify a Unit ID to send status messages.

■ **Intercom <Intcom>**

Allows communication between Control Head 1 and Control Head 2 in the dual head configuration without transmitting over the air.

■ **IP Address**

Displays the IP address.

■ **Key Delete <KeyDel>**

Allows you to delete the Encryption key. Refer to “DELETING THE ENCRYPTION KEY (AES (SCM*)/ DES (Built-in-DES or SCM*) and Enhanced Encryption only)” {p. 48} .

■ Key Lock <KeyLck>

Press this key to lock the transceiver keys. Press the key again to unlock the keys. The Power switch, as well as the PTT key on an external microphone or a Bluetooth device still function normally, and the following functions can still be operated: Auxiliary Input, Call Response, Clear, Emergency, Function, Hook, Key Lock, LCD Brightness, Monitor, Monitor Momentary, Squelch Off, Squelch Off Momentary and Zeroize.

■ Keypset <Keypset>

Allows you to change the active Keypset stored in a Secure Cryptographic Module (SCM).

■ Language

Allows you to change the language of the text display on the LCD screen and the language of the voice announcement. Refer to “MULTI LANGUAGE” {p. 55} .

■ LCD Brightness <Bright>

Allows you to adjust the brightness of the LCD backlight depending on the surrounding lighting conditions.

■ Lone Worker <LoneWk>

Enables or disables Lone Worker function.

■ Low Transmit Power <Low>

Turns Low Transmit Power on or off. When using a channel programmed with medium or high power, this allows you to change the output power to low.

■ Maintenance <Maint>

Allows you to display the signal strength, site information and Bit Error Rate (BER) on the LCD when constructing the system or during maintenance.

■ Manual Site Hunt <M.Hunt>

Enables or disables Manual Site Hunt function. Applicable to DMR Site Roaming only.

■ Master Volume Control <M_Vol.>

Allows you to switch the Control Head for controlling the volume of all the RF Decks.

■ Medium Transmit Power

Turns Medium Transmit Power on or off. When using a channel programmed with low or high power, this allows you to change the output power to medium.

■ Menu <Menu>

Press this key to select and perform functions using the transceiver Menu.

■ Mobile Relay Station <Relay>

Allows audio data received on one RF deck to be sent to the other RF deck and vice versa when two RF decks are used in the multi-RF deck configuration.

■ **Mic Sense**

Allows you to change the microphone sensitivity.

■ **Microphone Type**

Allows you to select a microphone type that suits the optional external microphone connected.

■ **Monitor <Moni>**

Allows you to turn the transceiver signaling off, to listen to all calls that are received on the channel.

■ **Monitor Momentary <Moni>**

Press and hold this key to momentarily turn the transceiver signaling off. Releasing this key turns the transceiver signaling back on. While signaling is off, you can listen to all calls that are received on the channel.

■ **Multi RF Deck View <View>**

Allows you to select whether to display the channel name of all the RF decks or only the channel name of the selected RF deck on the display of the Control Head. Refer to “MULTI RF DECK VIEW” {p. 53} .

■ **Operator Selectable Tone <OST>**

Refer to “Operator Selectable Tone (OST)” {p. 49} .

■ **OST Down <OST->**

Press this key to decrease the Operator Selectable Tone number of your selected channel.

■ **OST List**

Allows you to enter OST List mode.

■ **OST Up <OST+>**

Press this key to increase the Operator Selectable Tone number of your selected channel.

■ **OVCN <OVCN> (Open Voice Channel Mode)**

Allows the conversation of a received call to be heard even when the received ID does not match.

■ **Playback <Play>**

Refer to “Playback” {p. 80} .

■ **Playback (Last Recording) <Play_L>**

Refer to “Playback” {p. 80} .

■ **Priority-channel Select <OSP>**

Allows you to set a channel as a priority channel.

■ **Public Address <PA>**

Allows you to use the transceiver as a loudspeaker.

■ **Radio Check**

Allows you to check whether the transceiver can be communicated or not.

■ **Radio Inhibit**

Allows you to inhibit the transceiver operation by remote control.

■ **Radio Uninhibit**

Allows you to uninhibit the transceiver operation by remote control.

■ **Regroup Request <Regrp>**

Allows you to send a request to the dispatcher to join the talkgroup set up by the dispatcher. The channel name for the dynamic regroup channel appears on the display when the transceiver joins the talkgroup.

■ **Rekey Request <Rekey>**

Allows you to make a request to update the Encryption key.

■ **Remote Control <Remote>**

Allows you to remotely control a specified transceiver from this transceiver.

In the NXDN and DMR systems, it allows you to operate the transceiver directly, send a remote control message and control the target transceiver.

■ **RF Deck 1 ~ 3 <Deck 1 ~ Deck 3>**

In the multi-RF deck configuration, press this key to select the RF deck to be operated by the Control Head.

■ **RF Deck Down <DeckDn>**

In the multi-RF deck configuration, press this key to switch the Selected RF Deck in the Deck 1 → Deck 2 → Deck 3 order.

■ **RF Deck Select <Deck>**

Allows you to select the RF deck to be operated by the Control Head in the multi-RF deck configuration.

■ **RF Deck Up <DeckUp>**

In the multi-RF deck configuration, press this key to switch the Selected RF Deck in the Deck 3 → Deck 2 → Deck 1 order.

■ **RX Audio Equalizer (High)**

Allows you to set the audio response for high frequencies.

■ **RX Audio Equalizer (High Midrange)**

Allows you to set the audio response for high midrange frequencies.

■ RX Audio Equalizer (Midrange)

Allows you to set the audio response for midrange frequencies.

■ RX Audio Equalizer (Low Midrange)

Allows you to set the audio response for low midrange frequencies.

■ RX Audio Equalizer (Low)

Allows you to set the audio response for low frequencies.

■ RX Auto Gain Control

Allows you to set the transceiver to automatically adjust the volume of the receiving sound to a specific level for easy listening.

■ Save GPS Data <GPS_S>

Allows you to save the current date, time and location information on the microSD card.

■ Save Log Data <Log>

Allows you to save the operation and communication logs of this transceiver.

■ Scan <Scan>

Refer to “SCAN” {p. 40} .

■ Scan Delete/ Add <D/A>

Allows you to include or omit each channel in the scan sequence.

■ Scan Normal <ScnNrm>

Allows you to forcibly perform a non-priority scan even when priority scan has been set.

■ Scan Program <ScnPrg>

Allows you to reprogram the Scan List and Priority channels using your transceiver. Refer to “SCAN PROGRAMMING” {p. 41} .

■ Scrambler/ Encryption <Scr/ Encryp>

Allows you to prevent a third party from listening in on your call. Refer to “SCRAMBLER (ANALOG/ LTR)/ ENCRYPTION (P25/ NXDN/ DMR)” {p. 47} .

■ Scrambler/ Encryption Code

Allows you to change the scrambler code used in the transmission. Refer to “SCRAMBLER (ANALOG/ LTR)/ ENCRYPTION (P25/ NXDN/ DMR)” {p. 47} .

■ Send the GPS Data <GPS_TX>

Allows you to send your positioning data to the base station.

- You need to connect the KRA-40 GPS antenna.
- When the power is turned ON and/or the reception condition of the GPS satellite is poor, positioning may take longer to complete.
- When using the built-in GPS Receiver, “GPS Ant Fail” appears on the display if the GPS antenna is not connected or the connection is abnormal (e.g. short circuit).

■ **Short Message <SDM>**

Allows you to send short messages such as an address, telephone number, etc.

■ **Site Down <Site->**

Press this key to decrease the site number.

■ **Site Lock <SiteLk>**

Allows you to lock the current site. The transceiver will not be able to search for alternate sites, and “Site Lock” appears on the display.

■ **Site Number**

This displays the site number.

■ **Site Select**

Allows you to select the site to lock.

■ **Site Up <Site+>**

Press this key to increase the site number.

■ **Speaker 1-2 Mute <Mute>**

Allows you to mute the speaker audio from Control Head 1 via key operation on Control Head 2, and vice versa, in the dual head configuration.

■ **Speaker Attenuation <SP Atn>**

Press this key to attenuate received voice signals. This reduces the strength of the speaker output to cut back any noise and distortion present in the signal.

■ **Speaker Type**

Allows you to select a speaker type that suits the optional external speaker connected.

■ **Squelch Level <SQL>**

Allows you to adjust the transceiver squelch level.

When adjusting the squelch level, use the [▲] and [▼] keys to increase and decrease the squelch level from 0 (open) to 9 (tight). The default setting is 5.

■ **Squelch Off <SQ_Off>**

Allows you to turn the transceiver squelch off, to better hear weak signals on the channel.

■ **Squelch Off Momentary <SQ_Off>**

Press and hold this key to momentarily turn the transceiver squelch off. Releasing this key turns the transceiver squelch back on. While squelch is off, you can better hear weak signals on the channel.

■ **Stack <Stack>**

Allows you to check the records of received calls and messages received.

■ **Status <Status>**

Allows you to send status messages selected from the Status List.

■ **Surveillance <SrvInc>**

Allows you to disable the alert, tone, backlight and LED functions.

■ **System Down <Sys->**

Press this key to select a previous system name and enable System Lock to the system selected.

■ **System Lock <Sys Lk>**

Allows you to lock the current system via key operation so that it does not roam to other systems in Multi-System Roaming.

■ **System Search <Search>**

Allows you to view the current Trunking site. With the site displayed, press and hold the key programmed as [**System Search**] to enter Search mode. The transceiver begins searching for a new site and "Search" appears on the display. When a site is found, searching ends and the transceiver switches to the new site.

■ **System Select**

Allows you to select the system to lock.

■ **System Up <Sys+>**

Press this key to select a succeeding system name and enable System Lock to the system selected.

■ **Tactical Zone <Tac>**

Allows you to register the selected channel to form a new group (Tactical Zone).

■ **Talk Around <TA>**

Allows you to toggle Talk Around ON and OFF. Talk Around redirects the transceiver signals directly to other party members rather than relaying the signals through a repeater.

■ **Talkgroup Reset <TG_Rst>**

Allows you to reset the Talkgroup ID of a channel.

■ **Task Request Confirmation <Task>**

Allows you to check a received Task Request message (up to 290 characters) and respond to the message in the Task Request function.

The Task Request function manages tasks by using the Short Message function. The task administrator sends the operator a Task Request message of which the operator will check the instructions in the message and return a response message such as task started, task ended or rejected to the task administrator. This allows the task administrator to keep track of the progress of the operator. For details, consult your dealer.

■ Telephone Disconnect <Disc>

Allows you to disconnect the public telephone line connected through a repeater in LTR Trunking system.

■ Transceiver Password <Passwd>

Allows you to set a password to lock the transceiver.

■ TX Audio Equalizer (High)

Allows you to set the audio response for high frequencies.

■ TX Audio Equalizer (High Midrange)

Allows you to set the audio response for high midrange frequencies.

■ TX Audio Equalizer (Midrange)

Allows you to set the audio response for midrange frequencies.

■ TX Audio Equalizer (Low Midrange)

Allows you to set the audio response for low midrange frequencies.

■ TX Audio Equalizer (Low)

Allows you to set the audio response for low frequencies.

■ TX Auto Gain Control

Allows you to set the transceiver to automatically adjust the microphone sensitivity for easy listening.

■ Unselected RF Deck Speaker <SpMute>

Allows you to mute or unmute the external speaker connected to the RF deck that is not selected.

■ Unselected Speaker Offset

Allows you to reduce the output level of the external speaker connected to the RF deck that is not selected.

■ Voice Memo <Memo>

Allows you to record audio near the transceiver manually.

■ Volume Down <Vol->

Press this key to decrease the volume level.

■ Volume Up <Vol+>

Press this key to increase the volume level.

■ VOX <VOX>

Allows you to adjust the VOX Gain level.

■ VOX Function

Activates the VOX function. Refer to “VOICE OPERATED TRANSMISSION (VOX)” {p. 59} .

■ Zeroize <Zero>

Allows you to delete the Encryption keys stored in a Secure Cryptographic Module (SCM), configured in the built-in DES or configured with Enhanced Encryption.

■ Zone Delete/ Add <Zn_D/A>

Allows you to include or omit each Zone in the Multi-Zone scan sequence.

■ Zone Down <Zone->

Press this key to decrease the zone number. {p. 5}

■ Zone Up <Zone+>

Press this key to increase the zone number. {p. 5}

FUNCTION DETAILS

SCAN

Scan is useful for monitoring signals on the transceiver channels. While scanning, the transceiver checks for a signal on each channel and only stops on a channel if a signal is present.

To begin scanning, press the key programmed as **[Scan]**.

- The  indicator appears on the display.
- The channels are scanned.
- When a signal is detected on a channel, Scan pauses on that channel. The transceiver will remain on the busy channel until the signal is no longer present. When the signal “drops out”, the transceiver will remain on the channel momentarily before Scan resumes. This delay time is programmed by your dealer. If a signal is received during the delay time, the transceiver will remain on the same channel.

To stop scanning, press the **[Scan]** key again.

Note:

- In order for Scan to operate, there must be at least 2 channels added to the scanning sequence. If there are less channels than this, Scan will not operate.
-

TEMPORARY CHANNEL LOCKOUT

During scan, you can temporarily remove specific channels from the scanning sequence by selecting them and pressing the key programmed as **[Scan Delete/Add]**.



- The  indicator no longer appears on the display for that channel.
- The channel is no longer scanned. However, when scanning is ended and restarted, the channels will reset and the channel will again be in the scanning sequence.

PRIORITY SCAN

A Priority channel must be programmed in order for Priority Scan to function.

When using a single Priority channel, the transceiver will automatically change to the Priority channel when a call is received on it, even if a call is being received on a normal channel.

When using dual Priority channels, Priority channel 1 is given precedence over Priority channel 2. So, if a call is received on Priority channel 1 while a call is already on Priority channel 2, the transceiver will automatically change to Priority channel 1.

- “” or “” appears on the display when the channel is Priority channel 1 or 2 respectively.
- The  indicator (red) appears on the display during Priority Scan.

SCAN REVERT

The Scan Revert channel is the channel selected when you press the **PTT** switch to transmit during scan. Your dealer can program one of the following Scan Revert channels:

- **Selected:** The last channel selected is assigned as the new revert channel.
- **Selected + Talkback:** If the channel has been changed, the newly selected channel is assigned as the new revert channel. The transceiver “talks back” on the current channel.
- **Priority 1/ Priority 2:** If your dealer has programmed a Priority channel (either Priority 1 or Priority 2), this channel is the revert zone and channel.
- **Priority 1 + Talkback/ Priority 2 + Talkback:** If your dealer has programmed a Priority channel (either Priority 1 or Priority 2), this channel is the revert zone and channel. The transceiver “talks back” on the current receive channel.
- **Last Called + Selected:** The last channel on which you received a call is assigned as the new revert channel. The transceiver “talks back” on the current channel. If the channel has been changed, the newly selected channel is assigned as the new revert channel.



SCAN PROGRAMMING

Note:

- Scan programming is only available when Scan Type has been set to “List”.
-

■ Scan List Editing

You can reprogram your scan list to add or delete any zones or channels.

- 1 Select the channel where the scan list to be edited has been set, press the key programmed as [**Scan Program**] to enter Scan Program Mode.
Alternatively, press the key programmed as [**Menu**] to enter Scan Program Mode using the Menu Mode.
 - 2 Press the [**◀**] and [**▶**] keys to select the zone or the [**▲**] and [**▼**] keys to select the channel you will add to or remove from the scan list.
 - 3 Press the [**□**] key to confirm your selection.
 - The  indicator appears on the display when a zone is added to the scan list, and disappears when a zone is removed from the scan list.
 - The  indicator appears on the display when a channel is added to the scan list, and disappears when a channel is removed from the scan list.
 - 4 Press the [**⏏**] key to exit scan programming.
-

Note:

- A zone/ channel cannot be added to the scan list in the following cases.
 - When it has already been added to the scan list.
 - When a channel that is not compatible with the Scan Type in the Scan List setting has been selected. (E.g., a P25 Trunking channel is selected when Scan Type in the Scan List setting has been set to “Conventional”.)
 - A zone/ channel cannot be deleted from the scan list in the following cases.
 - When the channel to be deleted is a Priority channel.
 - When there is no added channel in the scan list.
-

■ Priority Channel Editing

If the Priority channel (Priority 1/ Priority 2) has been set as Operator Selectable by your dealer, you can reprogram the Priority channels.

Note:

- A zone/ channel must be added to the scan list before the channel can be set as a Priority channel.
 - The Priority channel cannot be reprogrammed on the NXDN Trunking scan list and when Scan Type has been set to "Limited Talkgroup".
-
- 1 Select the channel where the scan list to be edited has been set, press the key programmed as [**Scan Program**] to enter Scan Program Mode.
Alternatively, press the key programmed as [**Menu**] to enter Scan Program Mode using the Menu Mode.
 - 2 Press the [O] key to edit the Priority channel.
 - 3 Press the [▲] and [▼] keys to select the desired priority.
 - 4 Press the [□] key to confirm your selection.
 - 5 Press the [⬆] key to exit scan programming.

DTMF (DUAL TONE MULTI FREQUENCY) CALLS

Note:

- DTMF calls can be made only in Analog Conventional and NXDN Conventional Operation.

MAKING A DTMF CALL

■ Manual Dialing (Microphone keypad only)

- 1 Press and hold the **PTT** switch.
- 2 Enter the desired digits using the microphone keypad.
 - The corresponding DTMF tones sound each time you press a key.
 - If you release the **PTT** switch, transmit mode will end even if the complete number has not been sent.

■ Keypad Auto PTT (Microphone keypad only)

If your dealer has activated the Keypad Auto PTT function, simply press the microphone keys to make the call.

- The DTMF code will be sent automatically when you press a key.

■ Store & Send

- 1 Enter the desired digits using the microphone keypad.
 - The digits appear on the display as you enter them.
 - You can enter digits by using the [▲] and [▼] keys. Press these keys to cycle through the DTMF digits.
 - You can enter up to 34 digits before transmitting.
- 2 After entering the complete number, press the **PTT** switch to transmit.

■ Stun Code

This function is used when a transceiver is stolen or lost.

When the transceiver receives a call containing a stun code, either the transmit mode or both the receive and transmit mode will be disabled. The stun code is canceled when the transceiver receives a call with a revive code.

MAKING A TELEPHONE CALL (P25 AND NXDN TRUNKING)

■ Autodial

Autodial allows you to quickly call numbers that have been programmed onto your transceiver.

- 1 Press the key programmed as **[Autodial]** to enter Autodial Mode.
Alternatively, press the key programmed as **[Menu]** to enter Autodial Mode using the Menu Mode.
 - The first entry in the Autodial list appears on the display.
- 2 Press the **[▲]** and **[▼]** keys to select your desired Autodial list number.
- 3 Press the **PTT** switch to make the call.

■ Autodial Programming

You can reprogram your Autodial list to add or delete any DTMF Codes.

- 1 Press the key programmed as **[Autodial Programming]** to enter Autodial Programming Mode. Alternatively, press the key programmed as **[Menu]** to enter Autodial Programming Mode using the Menu Mode.
 - The first entry in the Autodial list appears on the display.
- 2 Press the **[▲]** and **[▼]** keys to select your desired list.
- 3 Press the **[↵]** key to delete the Autodial list.
- 4 Press the **[□]** key to edit the Autodial list.
- 5 Press the **[□]** key to confirm your selection.
- 6 Press the **[⏏]** key to exit Autodial Programming Mode.

■ Manual Dialing

- 1 Press the key programmed as **[Autodial]** to enter Autodial Mode.
Alternatively, press the key programmed as **[Menu]** to enter Autodial Mode using the Menu Mode.
 - The last called unit appears on the display.
- 2 Press the **[O]** key to enter manual input mode.
- 3 Enter your desired number.
 - You can select a digit by using the **[▲]** and **[▼]** keys, and then set the selected digit by pressing the **[□]** key. Repeat this process to enter the entire number.
Alternatively, on an optional microphone with keypad, you can enter the number directly.
- 4 Press the **PTT** switch to make the call.
- 5 To end the call, press the key programmed as **[Clear]**.

■ Selecting a Number from the List

- 1 Press the key programmed as **[Autodial]** to enter Autodial Mode.
Alternatively, press the key programmed as **[Menu]** to enter Autodial Mode using the Menu Mode.
 - The last called unit appears on the display.
- 2 Press the **[▲]** and **[▼]** keys to select your desired list number.
- 3 Press the **PTT** switch to make the call.

MAKING A TELEPHONE CALL (LTR TRUNKING)

■ Manual Dialing

- 1 Select the desired zone and telephone group ID.
- 2 Press the **PTT** switch to start the call.
- 3 Enter the desired number using the DTMF keypad.

■ Selecting a Number from the List

- 1 Select the desired zone and telephone group ID.
- 2 Press the key programmed as **[Autodial]** to enter Autodial Mode.
Alternatively, press the key programmed as **[Menu]** to enter Autodial Mode using the Menu Mode.
 - The last called unit appears on the display.
- 3 Press the **[▲]** and **[▼]** keys to select your desired list number.
- 4 Press the **PTT** switch to make the call.

RECEIVING A TELEPHONE CALL

- 1 When a call is received, "Phone Call" will appear on the display.
- 2 Press and hold the **PTT** switch to speak, and release it to receive.
 - Only one person can speak at a time.
- 3 To end the call, press the key programmed as **[Clear]**.

MAKING A STATUS CALL

- 1 Select your desired zone and channel.
- 2 Press the key programmed as **[Status]** to enter Status mode.
Alternatively, press the key programmed as **[Menu]** to enter Status mode using the Menu Mode.
- 3 Press the **[▲]** and **[▼]** keys to select the status ID you want to transmit.
- 4 Press the **PTT** switch or the **[□]** key to initiate the Status call.
 - After the status call has been successfully received by the called unit, "Complete" appears on the display.

EMERGENCY CALLS

If your transceiver has been programmed with the Emergency function, you can make emergency calls.

Note:

- Only the Auxiliary (orange) key can be programmed with the Emergency function.
-

- 1 Press and hold the key programmed as **[Emergency]**.
 - Depending on the delay time programmed into your transceiver, the length of time you must hold the Emergency key will vary.
 - When the transceiver enters Emergency mode, the transceiver will change to the Emergency channel and begin transmitting based on how the transceiver is set up by your dealer. Transmit periods are also set by your dealer.
 - 2 To exit Emergency mode, press and hold the **[Emergency]** key again.
 - If the Emergency mode completes a preset number of cycles, Emergency mode will automatically end and the transceiver will return to the zone and channel that was in use before Emergency mode was entered.
-

Note:

- Your dealer can set the transceiver to emit a tone when Emergency mode starts and stops.
 - Your dealer can set the transceiver to emit tones and received signals as normal or mute the speaker during Emergency operation.
-

SCRAMBLER (ANALOG/ LTR)/ ENCRYPTION (P25/ NXDN/ DMR)



Note:

- The Scrambler function can be used only in Analog Conventional and LTR Trunking Operation.
- The following types of encryption are available depending on the system used.
NXDN : Bit scrambling (built-in encryption function), AES (SCM*) and DES (built-in-DES or SCM*)
P25 : AES (SCM*) and DES (built-in-DES or SCM*)
DMR : Bit scrambling (built-in encryption function), AES (SCM*), DES (built-in-DES or SCM*) and Enhanced Encryption
- * SCM (Secure Cryptographic Module) is a hardware cryptographic module developed by JVC KENWOOD to provide cryptographic securities for digital two way radios.
- The transceiver includes a built-in DES that allows you to set up to four Encryption keys.
- SCM and the built-in DES cannot be operated simultaneously.
- Ask your dealer for details concerning the Encryption DES/ AES and Enhanced Encryption settings.

SECURE (ENCRYPTED) TRANSMISSION

Press the key programmed as [**Scrambler/ Encryption**] to switch the transceiver to secure (encrypted) transmission.

Alternatively, press the key programmed as [**Menu**] to enter Scrambler/ Encryption Mode using the Menu Mode.

- The Scrambler indicator () or Encryption indicator ()* appears when the respective function is turned ON.
- Pressing the **PTT** switch after the Scrambler or Encryption function has been turned ON encrypts the transmitted signal.
- Each group member must activate their respective Scrambler/ Encryption functions to descramble/ decrypt the received signals.

* The indicator displayed varies depending on the type of Encryption function activated. Refer to "INDICATOR LIST" {p. 82} .

SELECTING THE SCRAMBLER CODE

- 1 Press the key programmed as [**Scrambler/ Encryption Code**] to enter Scrambler/ Encryption Code Mode.
Alternatively, press the key programmed as [**Menu**] to enter Scrambler/ Encryption Code Mode using the Menu Mode.
- 2 Press the [**▲**] and [**▼**] keys to increase or decrease the Scrambler code.
 - Up to 16 Scrambler codes can be used.
 - Each group member must use the same code in order for the transceivers to descramble the received signals.
- 3 Press the [**□**] key to set the new Scrambler code.

SELECTING THE ENCRYPTION KEY

- 1 Press the key programmed as [**Scrambler/ Encryption Code**] to enter Scrambler/ Encryption Code Mode.
Alternatively, press the key programmed as [**Menu**] to enter Scrambler/ Encryption Code Mode using the Menu Mode.

- 2 Select the new Encryption key using the [▲] and [▼] keys.
 - Up to 32 Encryption keys can be used. One of these keys will be used during transmission.
 - 3 Press the [□] key to set the new Encryption key.
-

Note:

- The selecting of encryption key is not available in P25 Trunking systems.
 - To restore to the default Encryption key, select "Preset". However, if you delete the Encryption key, it will not be recovered.
-

DELETING THE ENCRYPTION KEY (AES (SCM*)/ DES (Built-in-DES or SCM*) and Enhanced Encryption only)

- 1 Press the key programmed as [**Key Delete**] to enter Key Delete Mode. Alternatively, press the key programmed as [**Menu**] to enter Key Delete Mode using the Menu Mode.
 - 2 Select the current Encryption key using the [▲] and [▼] keys.
 - 3 Press the [↵] key to delete the Encryption key.
 - 4 Press the [□] key to confirm and exit Key Delete Mode.
-

Note:

- To delete all Encryption keys (when more than one key has been set up), press and hold the [↵] key for 1 second.
-

PASSWORD PROTECTION

If the transceiver is password protected, entering an incorrect password successively 15 times will automatically delete all the Encryption keys.

- Turning the transceiver power OFF and the ON again will not reset the number of attempts for entering an incorrect password.

QUIET TALK (QT)/ DIGITAL QUIET TALK (DQT)

Your dealer may have programmed QT or DQT signaling on your transceiver channels. A QT tone/ DQT code is a sub-audible tone/ code which allows you to ignore (not hear) calls from other parties who are using the same channel.

When a channel is set up with a QT tone or DQT code, squelch will only open when a call containing a matching tone or code is received. Likewise, signals that you transmit will only be heard by parties whose QT/ DQT signaling matches your transceiver.

If a call containing a different tone or code is made on the same channel you are using, squelch will not open and you will not hear the call. This allows you to ignore (not hear) these calls. Although it may seem like you have your own private channel while using QT/ DQT, other parties can still hear your calls if they set up their transceiver with the same tone or code.

■ Operator Selectable Tone (OST)

If a key has been programmed with [**Operator Selectable Tone**], you can reprogram the QT tone or DQT code on each of your channels.

- 1 Select your desired channel.
- 2 Press and hold the key programmed as [**Operator Selectable Tone**].
 - Alternatively, you can press the key programmed as [**Menu**] to enter OST Mode using the Menu Mode.
 - The  indicator appears on the display.
- 3 Press the [**▲**] and [**▼**] keys to select your desired tone or code from 1 to 40.
- 4 Press the [**□**] key to save your new setting.

After selecting and setting up your desired tone or code, press the [**Operator Selectable Tone**] key to activate the OST function. Press this key again to turn the OST function off.

NETWORK ACCESS CODE (NAC)

Your dealer may have programmed a Network Access Code on your transceiver channels. NAC is a feature of P25 transceivers that functions similarly to QT/DQT; squelch will open when the correct NAC is received.

RADIO ACCESS NUMBER (RAN)

RAN is a signaling system designed for digital radio communications.

When a channel is set up with a RAN, squelch will only open when a call containing a matching RAN is received. If a call containing a different RAN is made on the same channel you are using, you will not hear the call. This allows you to ignore (not hear) calls from other parties who are using the same channel.

COLOR CODE (CC)

Color Code is a digital signaling for DMR system to enable smooth communication among groups using the same channel.

OPTIONAL SIGNALING

Your dealer may also program several types of optional signaling for your transceiver channels.

■ 2-tone Signaling

2-tone Signaling opens the squelch only when your transceiver receives a call containing a matching 2-tone signal.

- 1 Press the key programmed as **[2-tone]**.
 - Alternatively, you can press the key programmed as **[Menu]** to enter 2-tone Mode using the Menu Mode.
- 2 Press the **[▲]** and **[▼]** keys to select your desired list of 2-tone codes.
- 3 Press the **PTT** switch to make the call.

■ DTMF Signaling

DTMF Signaling opens the squelch only when the transceiver receives a call containing a matching DTMF code.

■ MDC-1200 Signaling

MDC-1200 is a data system using Audio Frequency Shift Keying (AFSK).

■ FleetSync Signaling

FleetSync Signaling opens the squelch only when the transceiver receives a call that matches the FleetSync ID in FleetSync Signaling.

■ NXDN ID Signaling

NXDN ID is an optional signaling system available only for digital communications.

CLOCK

Your transceiver can track the time with its built-in clock. If activated by your dealer, the time will be displayed when the transceiver power is turned ON.

Note:

- Removing or leaving the battery pack uncharged for extended periods will cause the clock time to clear.
-

CLOCK ADJUSTMENT

To set the time:

- 1 Press the key programmed as [**Clock Adjustment**] to enter Clock Adjustment Mode.
Alternatively, press the key programmed as [**Menu**] to enter Clock Adjustment Mode using the Menu Mode.
 - The current time setting appears.
- 2 Press the [▲]/[▼] keys to increase or decrease the month setting.
- 3 Press the [▶] key to set the month and cycle to the day setting.
- 4 Repeat steps 2 and 3 to set the day, year, hour, and minute.
- 5 Press the [□] key to exit Clock Adjustment mode.
 - You can press the [⏏] key at any time to exit Clock Adjustment mode.

COLOR SCHEME

There are four available color schemes as follows.

Full Color



Full Color White

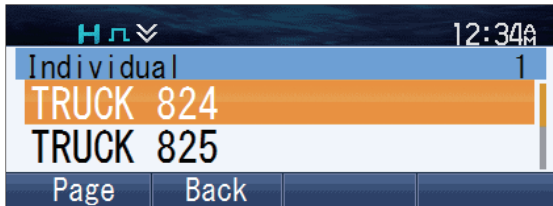

Monochrome Black

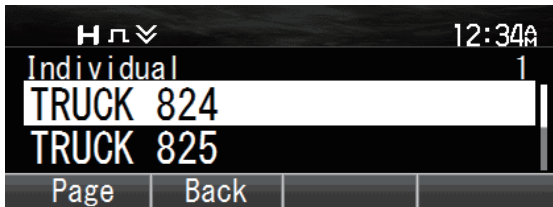

Monochrome White

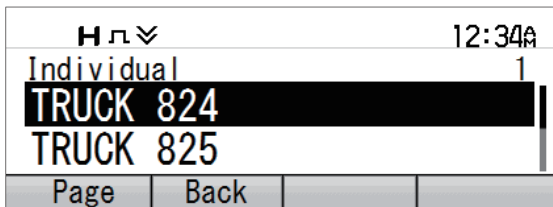

To select a Color Scheme:

- 1 Press the key programmed as **[Menu]** to enter Color Scheme Mode using the Menu Mode.
- 2 Press the **[▲]** and **[▼]** keys to select your desired color scheme.
- 3 Press the **[□]** key to confirm your selection.

Note:

- The Color Scheme setting is reflected in the color of the logo display during startup {p. 4}. However, this setting does not affect the display color of the Custom Start-up Screen.

MULTI RF DECK VIEW

Note:

- This function is only available when the optional KCH-20R featured panel or optional KCH-21R handheld control head is used.

This transceiver is equipped with Multi RF Deck and Multi Control Head functions, where up to three RF Decks (transceiver) and up to two Control Heads (attached panel, optional KCH-20R featured panel and/or optional KCH-21R handheld control head) can be connected to operate as a system. For details, consult your dealer. In the Multi RF Deck system, only one RF Deck (known as Selected RF Deck) can be controlled by the Control Head. The information, such as channel name, of the Selected RF Deck is displayed on the LCD display of the Control Head. The information of the other unselected RF decks in the Multi RF Deck system can also be displayed simultaneously on the LCD display.

The following are display examples of the system configured with three RF Decks when the optional KCH-20R featured panel or optional KCH-21R handheld control head is used and your dealer has enabled the Multi RF Deck View function:

KCH-20R Featured Panel



KCH-21R Handheld Control Head

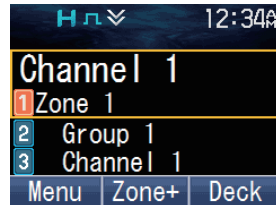

The following icons are the respective RF deck numbers.

- 1**: Selected RF Deck 1, **2**: Unselected RF Deck 2 and **3**: Unselected RF Deck 3

In the case of a system configured with two RF Decks, the displays are as follows:

KCH-20R Featured Panel

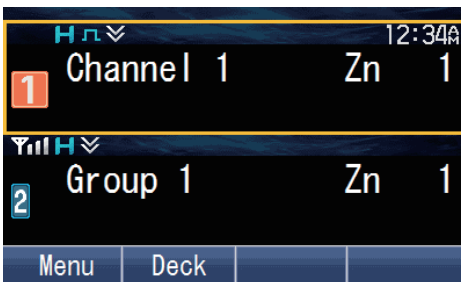

KCH-21R Handheld Control Head

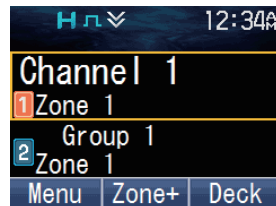

Note:

- In the Dual Control Head configuration, the display for both Control Head 1 and Control Head 2 is the same.

Pressing the key programmed as **[RF Deck Select]** or **[RF Deck 2]** for example switches the Selected RF Deck to RF Deck 2 as follows:

Alternatively, press the key programmed as **[RF Deck Down]** or **[RF Deck Up]** to switch the Selected RF Deck.

KCH-20R Featured Panel

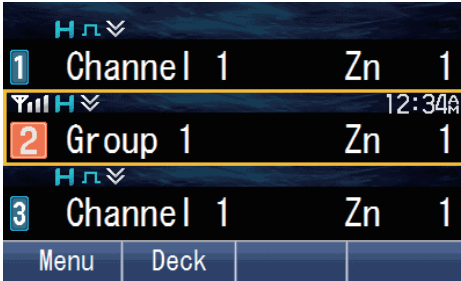

KCH-21R Handheld Control Head

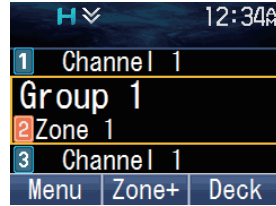

To turn off Multi RF Deck View, press the key programmed as **[Multi RF Deck View]**. Only the information of the Selected RF Deck is displayed.

Alternatively, press the key programmed as **[Menu]** to enter Multi RF Deck View Mode using the Menu Mode. Press **[▲]/[▼]** to select "Off", then press the **[□]** key to disable Multi RF Deck View.

KCH-20R Featured Panel

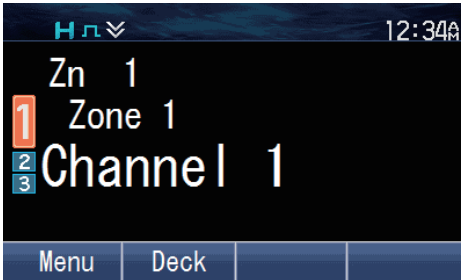

KCH-21R Handheld Control Head



MULTI LANGUAGE

Your transceiver is equipped with multiple language support feature. You can change the language of the text display on the LCD screen and the language of the voice announcement. There are three languages available for selection; however, the languages selectable are dependent on the dealer setting. For details, consult your dealer.

- 1 Press the key programmed as **[Menu]** to enter Language Mode using the Menu Mode.
- 2 Press the **[▲]/[▼]** keys to select the desired language.
- 3 Press the **[□]** key to confirm and exit Language Mode.
 - The language of the LCD screen display and the voice announcement changes to the language selected.

Note:

- The language of the voice announcement may not change depending on the dealer setting. For details, consult your dealer.
-

FleetSync: ALPHANUMERIC 2-WAY PAGING FUNCTION

FleetSync is an Alphanumeric 2-way Paging Function, and is a protocol owned by JVC KENWOOD Corporation. FleetSync enables a variety of paging functions on your transceiver, some of which depend on dealer programming.

Note:

- This function is available only in analog operation.

SELCALL (SELECTIVE CALLING)

A Selcall is a voice call to a station or group of stations.

■ Transmitting

- 1 Select your desired zone and channel.
- 2 Press the key programmed as **[Individual]/ [Individual + Status]/ [Individual + Short Message]/ [Group]/ [Group + Status]** or **[Group + Short Message]** to enter Selcall Mode.
Alternatively, press the key programmed as **[Menu]** to enter Selcall Mode using Individual/ Individual + Status/ Individual + Short Message/ Group/ Group + Status or Group + Short Message in the Menu Mode.
- 3 Press the **[▲]** and **[▼]** keys to select the station you want to call.
 - If Manual Dialing is enabled, you can enter a station ID using the microphone keypad or the **[▲]/[▼]** key. When using the **[▲]** and **[▼]** keys, cycle through the digits to select a digit, then press the **[□]** key to set the digit and move the cursor to the right. Repeat this process until the entire ID is entered.
- 4 Press the **PTT** switch and begin your conversation.

■ Receiving

An alert tone will sound and the transceiver will enter Selcall mode. The calling station's ID will appear when a Selcall is received. You can respond to the call by pressing the **PTT** switch and speaking into the microphone.

■ Identification Codes

An ID code is a combination of a 3-digit Fleet ID number and a 4-digit ID number. Each transceiver has its own ID.

- Enter a Fleet number (100 ~ 349) to make a fleet call.
- Enter an ID number (1000 ~ 4999) to make an individual call in your fleet.
- Enter a Group ID (which is programmed in the FPU) to make a group call.
- Enter a Fleet number followed by an ID number to make an individual call in your desired fleet (Inter-fleet call).
- Select "ALL" Fleet and "ALL" ID to make a call to all units (Broadcast call).
- Select "ALL" Fleet and enter an ID number to make a call to the selected ID in all fleets (Supervisor call).

STATUS MESSAGE

You can send and receive 2-digit Status messages which may be decided in your talk group. Messages can contain up to 16 alphanumeric characters. Status messages range from 10 to 99 (80 ~ 99 are reserved for special messages). A maximum of 250 received messages can be stored in the stack memory of your transceiver. These saved messages can be reviewed after reception. Depending on your dealer settings, when the stack memory is full, either the oldest message will be erased when a new message is received or the new message will not be stored in the stack memory. The  indicator appears when a message is stored in the stack memory.



■ Transmitting

- 1 Select your desired zone and channel.
- 2 Press the key programmed as **[Status]** to enter Status mode (proceed to step 5), or **[Individual + Status]/ [Group + Status]** to enter Selcall mode (proceed to step 3).
- 3 Press the **[▲]** and **[▼]** keys to select the station you want to call.
 - If Manual Dialing is enabled, you can enter a station ID using the microphone keypad or the **[▲]/[▼]** key. When using the **[▲]** and **[▼]** keys, cycle through the digits to select a digit, then press the **[□]** key to set the digit and move the cursor to the right. Repeat this process until the entire ID is entered.
- 4 Press the **[▶]** key to enter Status mode.
- 5 Press the **[▲]** and **[▼]** keys to select the status you want to transmit.
 - If Manual Dialing is enabled, you can enter a status ID using the microphone keypad or the **[▲]/[▼]** key (refer to step 3, above).
- 6 Press the **PTT** switch to initiate the call.
 - “Complete” appears on the display when the status has been successfully transmitted.

■ Receiving

The  indicator will flash and a calling ID and status message will appear when a Status call is received. Press any key to return to normal operation.

■ Reviewing Messages in the Stack Memory

- 1 Press the key programmed as **[Stack]**, or press and hold the key programmed as **[Individual]**, **[Group]**, **[Status]**, **[Individual + Status]**, or **[Group + Status]** to enter Stack mode.
 - The category list is displayed.
However, depending on the stack settings programmed by your dealer, the individual list (Caller ID, Status Message or Short Message) may be displayed instead of the category list. For details on the stack settings, consult your dealer.
 - The categories are identified as follows:
 : Caller ID,  : Status Message,  : Short Message
- 2 Press the **[▲]** and **[▼]** keys to select the desired category, then press the **[□]** key.
 - The Caller ID list, Status Message list or Short Message list is displayed according to the category selected. Pressing the **[◀]/[▶]** keys allows you to cycle the display information as follows.

- While Caller ID list is displayed:
[◀]: Caller ID > CH > Time Stamp
[▶]: Caller ID > Time Stamp > CH
- While Status Message list or Short Message list is displayed:
[◀]: Message > Caller ID > CH > Time Stamp
[▶]: Message > Time Stamp > CH > Caller ID
- To delete the selected message, press the [↵] key. To delete all messages, press and hold the [↵] key for one second.

3 Press [⏪] to return to normal operation.

SHORT MESSAGES

This transceiver can receive short data messages which contain a maximum of 48 characters.

- Short messages received are displayed the same as Status messages and are stored in the same stack memory. A maximum of 32, 64 or 128 short messages can be stored in the stack memory depending on the Short Message Stack setting of each system.

LONG MESSAGES

To send and receive long messages, you must connect the transceiver to a PC. Ask your dealer for details.

- Long messages can contain a maximum of 4096 characters.

GPS REPORT

GPS data can be manually transmitted by pressing the key programmed as **[Send the GPS Data]**, or by accessing the Menu {p. 15} . If set up by your dealer, GPS data may be automatically transmitted at a preset time interval.

- When using the GPS function, you must first connect the VHF/ GPS antenna or UHF/ GPS antenna.

VOICE OPERATED TRANSMISSION (VOX)

VOX can be activated or deactivated by your dealer. VOX operation allows you to transmit hands-free.

Note:

- ◆ To operate VOX, you must use an optional headset connected via the Bluetooth Headset Profile. Refer to “Bluetooth” {p. 63}.
 - ◆ Microphones such as KMC-28 cannot be used to operate VOX.
-

■ VOX Gain Level

Sets the Mic input sensitivity of the VOX operation.

- 1 Connect a headset to the transceiver.
- 2 Press the key programmed as **[VOX]**.
 - The current VOX Gain level appears on the display.
- 3 Press the **[▲]** or **[▼]** key to increase or decrease the VOX Gain level.
 - The VOX Gain can be adjusted from levels 1 to 10.
- 4 While adjusting the level, speak into the headset microphone to test the sensitivity level. (Your voice is not transmitted during this test procedure.)
 - When sound is recognized, the LED lights yellow.
- 5 Press the **[□]** key to save your new setting.

■ VOX Operation

- 1 Connect a headset to the transceiver.
 - The VOX function does not activate when a headset is not connected to the accessory terminal of the transceiver.
 - 2 Press and hold the key programmed as **[VOX]**.
 - Alternatively, you can press the key programmed as **[Menu]** to enter VOX Mode using the Menu Mode.
 - A beep will sound and the  indicator appears on the display.
 - 3 When you finish speaking, transmission ends.

To turn the VOX function OFF, press and hold the key programmed as **[VOX]** key again.

 - A beep will sound and the  indicator will disappear from the display.
-

Note:

- If a speaker/ microphone is connected to the transceiver while VOX is ON, and the VOX Gain Level is set to a sensitive level, louder received signals may cause the transceiver to transmit.
-

BACKGROUND OPERATIONS

TIME-OUT TIMER (TOT)

The Time-out Timer can be activated only on Conventional channels and in NXDN Trunking system. It is used to prevent any caller from using a channel for an extended period of time.

If you continuously transmit for a period of time that exceeds the programmed time, the transceiver will stop transmitting and an alert tone will sound. To stop the tone, release the **PTT** switch. Your dealer can program the TOT time in the range of 15 seconds to 20 minutes.

If programmed by your dealer, a pre-alert tone will sound before the timer expires. Also, if programmed by your dealer, you may have to wait for a short duration before you can continue to transmit. If you press the **PTT** switch before the timer has been reset, an alert tone will sound and the transceiver will not enter transmit mode.

BATTERY SAVER

The Battery Saver function can be activated only on Conventional channels. When activated, this function decreases the amount of power used when a signal is not being received and no operations are being performed (no keys are being pressed). While the channel is not busy and no operation is performed for 5 seconds, Battery Saver activates. When a signal is received or an operation is performed, Battery Saver is disabled.

LOW BATTERY WARNING

Low Battery Warning notifies you that transmission is not allowed due to a voltage drop in the vehicle battery.

Your dealer can set an alert tone to sound and the LED indicator to blink red when the voltage drops below the acceptable level.

SIGNAL STRENGTH INDICATOR

The signal strength indicator displays the strength of received calls.



Strong signal



Sufficient signal



Weak signal



Very weak signal



Out of service range
(Appears on NXDN Trunking and P25 Trunking channels only)

COMPANDER

The compander can be programmed only for specific analog channels. If it has been programmed by your dealer, transmitted signals are compressed before being sent and received signals are expanded when they arrive.

- Your dealer must set the compander for both the transmit side and the receive side in order for the compander to operate.
- The **IC** indicator appears on the display when the compander activates.

This background feature allows higher clarity of signals, avoiding excessive noise and interference. This feature is not used on digital channels, as they are not susceptible to noise and interference.

BUSY CHANNEL LOCKOUT (BCL)

On Conventional channels, if BCL is set up by your dealer, you will be unable to transmit on the channel if it is already in use. Under these circumstances, use a different channel or wait until the channel becomes free.

However, if BCL Override has also been programmed, you can transmit over the current signal:

- 1 Press and hold the **PTT** switch.
 - If the channel is already in use, a warning tone will sound.
- 2 Release the **PTT** switch, then press and hold the **PTT** switch again within half a second.
- 3 Speak into the transceiver as you would during a normal call.

OUT OF RANGE

On P25 Trunking and NXDN Trunking channels, if set up by your dealer, the transceiver will indicate when it is out of range. When it can no longer communicate with any site, an out of range tone sounds and “Out of Range” appears on the display. If enabled by your dealer, an In-service Tone will sound when an available control channel is detected after the out of range tone has sounded. For details on the in-service tone, consult your dealer.

SITE TRUNKING (P25 Trunking)/ NETWORK FAILURE (NXDN Trunking)

On Trunking channels, if set up by your dealer, the transceiver will indicate a network condition on the registered site. “Site Trunk” (P25)/ “Network Fail” (NXDN) appears on the display when the transceiver receives a network disabled message.

CONTROL CHANNEL HUNT

On P25 Trunking and NXDN Trunking channels, the transceiver must search for a control channel. While searching for a control channel, no signals can be received. The search begins automatically when you change to a Trunking channel.

- While hunting for a channel, the antenna indicator will flash. When a control channel has been found, the antenna indicator remains on the display without flashing.

VOICE ANNOUNCEMENT

An audio voice will be announced as below by dealer setting.

- When changing the zone and/or channel, the new zone and channel number are announced.
- When changing the status, the new status is announced.
- When changing the function setting, the new setting is announced.

Bluetooth

If your transceiver has been programmed with the Bluetooth function, you can connect your transceiver with a Bluetooth headset to make hands-free calls.

The Bluetooth specifications are as follows.

Version : Version 3.0
Power class : Class 2 (2.5 mW, up to 10 m)
Profile : Headset Profile (HSP), Serial Port Profile (SPP)
Device class : Phone

Note:

- The communication distance varies depending on the obstacles between the communication devices and the radio wave conditions.
- Only headsets which support the Headset Profile (HSP) certified by Bluetooth SIG can be used with the transceiver. However, operations are not guaranteed in all headsets.
- Refer to the following URL for details on the Bluetooth devices operationally tested by

KENWOOD:

http://manual2.jvckenwood.com/com/help_ref/nx5000_series/compatible_model_list/CNMJSYnnzoitpv.html

If you wish to use a Bluetooth device that is not operationally tested, please consult your dealer.

If the Bluetooth Data is enabled by your dealer, you can make a wireless connection between your transceiver and the Bluetooth-enabled device such as a PC using the Serial Port Profile. With the Serial Port Profile, you can connect your transceiver to a PC without using a programming cable to communicate with the Field Programming Unit (FPU) or to use the PC Interface Protocol.

For details on the Field Programming Unit (FPU) or PC Interface Protocol, consult your dealer.

■ Selecting the Bluetooth headset type

You can select the type of Bluetooth headset to be connected to the transceiver via HSP connection.

- 1 Press the key programmed as **[Menu]** to enter Bluetooth Headset Connection Type Mode using the Menu Mode.
 - 2 Press the **[▲]** and **[▼]** keys to select the desired headset type.
 - 3 Press the **[□]** key to confirm the selection.
 - The selection is backed up and will take effect the next time the transceiver is turned on.
-

Note:

- If you exit the Bluetooth Headset Connection Type Mode without pressing the **[□]** key, the headset type selected will not be reflected in the menu setting.
- Most Bluetooth headsets can be connected and operated by selecting “Headset 1” in “Bluetooth Headset Connection Type”. For some headsets, it is necessary to select “Headset 2”. For details, refer to the following URL:

http://manual2.jvckenwood.com/com/help_ref/nx5000_series/compatible_model_list/CNMJSYnnzoitpv.html

TURNING Bluetooth ON/ OFF

Press the key programmed as **[Bluetooth]** to turn the Bluetooth function on or off. Alternatively, press the key programmed as **[Menu]** to enter Bluetooth Mode using the Menu Mode.

Press the **[▲]** and **[▼]** keys to select “On” or “Off”.

Press the **[□]** key to confirm your selection.

- “” appears on the display when the Bluetooth function is turned on. If a Bluetooth device is already connected to your transceiver, “” appears on the display.

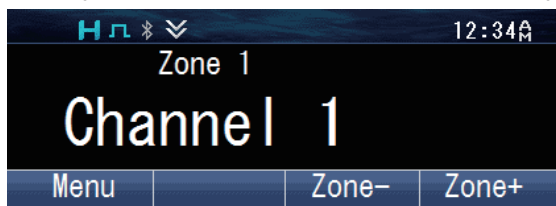

FINDING Bluetooth DEVICES

Your transceiver can automatically search for Bluetooth devices.

Note:

- Put your Bluetooth headset into pairing standby mode beforehand.

- 1 Press the **[□]** key to enter Menu Mode.

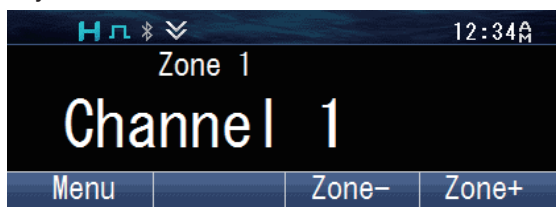

- 2 Press the **[□]** key to select the Bluetooth category.



- 3 Press the **[□]** key or the **[▲]** and **[▼]** keys to select “BT Device”.

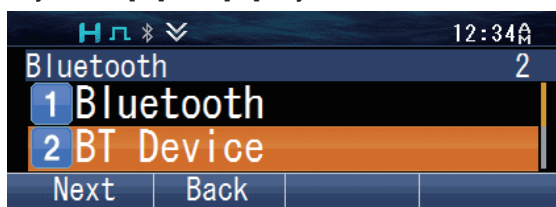

- 4 Press the [□] key or the [▲] and [▼] keys to select “Find Device”.

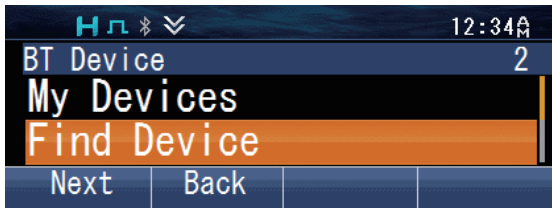

The transceiver starts to search for available Bluetooth devices. Up to 16 devices can be found and listed on the display.

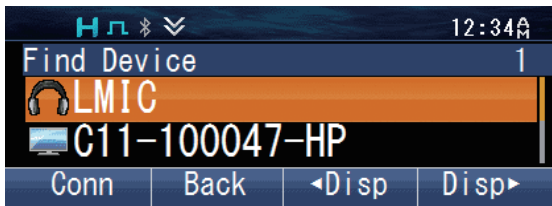
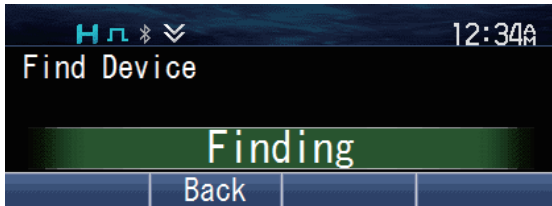

- The search will end after approximately 30 or 40 seconds (depending on whether or not the Bluetooth Data setting is enabled by the dealer), or when 16 devices have been found.

■ Pairing Bluetooth devices

- 1 Press the [▲] and [▼] keys to select the device to connect to. In this case, select the headset device.

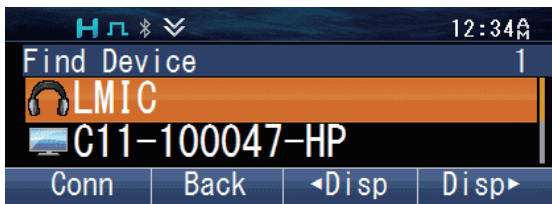

- 2 Press the [□] key to connect.

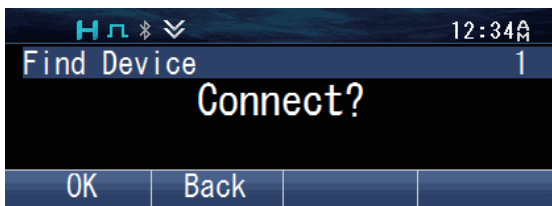

3 Press the [OK] key to start pairing.

Alternatively, you can pressed the key programmed as **[Bluetooth Connect/ Disconnect]**.

- The LED indicator blinks in blue.
- For Bluetooth devices that does not support Simple Secure Pairing, you need to enter a Personal Identification Number (PIN) code. You need to operate the Bluetooth headset to proceed with pairing.

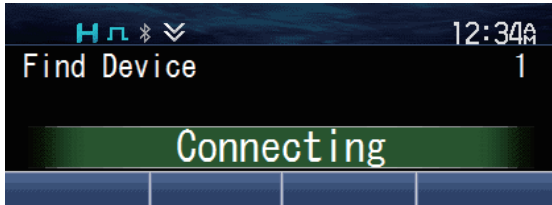

When pairing is complete, your transceiver will connect to the Bluetooth headset. When the connection is established, you can perform hands-free call.

- The “” indicator appears on the display.

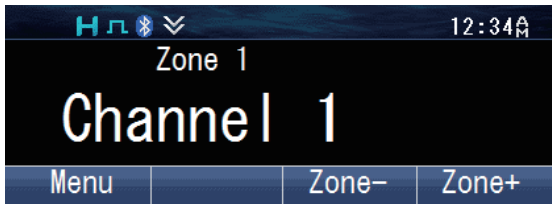
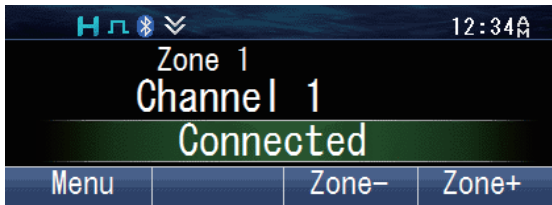

Note:

- Once the headset has been paired, it can be used automatically with the transceiver the next time the transceiver and headset are powered on. If the headset cannot be used automatically, connect manually using the My Device setting in the Bluetooth menu of the transceiver.
(Some headset models cannot be used automatically.)
 - Up to 10 Bluetooth devices can be registered to your transceiver.
 - The pressing of the key programmed as Bluetooth Connect/ Disconnect does not affect the status of the Bluetooth connection via Serial Port Profile.
-

■ Making hands-free call

Press the **PTT** switch to activate the microphone of the Bluetooth headset.

Note:

- The volume level can only be adjusted on the Bluetooth headset. The volume control of the transceiver does not function. However, if the audio is set to output from the built-in speaker of the transceiver in the Bluetooth Speaker setting, the volume level is controlled by the transceiver.
 - The microphone sensitivity can be set using the External Mic Sense function.
-

■ Connecting to a PC

To connect to a PC using the Serial Port Profile, you have to make a request for connection from the PC to your transceiver. The transceiver will start to connect once it received the request from the PC.

Once the connection has been established, your transceiver can start communicating with the Field Programming Unit (FPU) or you can use the PC Interface Protocol.

- The “” indicator appears on the display.

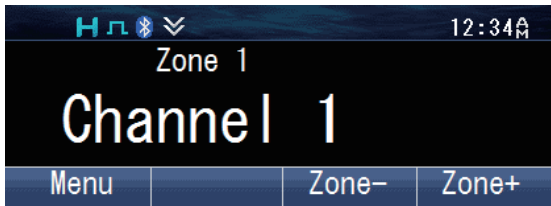
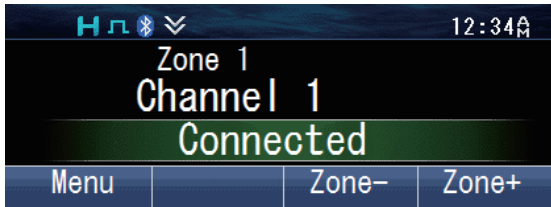

The transceiver transits to each mode when the FPU communication begins. To use the PC Interface Protocol, run the PC commands.

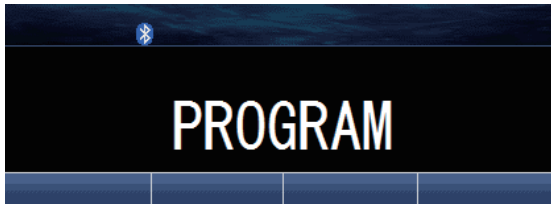

USEFUL FUNCTIONS

There are some useful functions on your transceiver which allows you to display information of the Bluetooth devices registered to the transceiver and to switch the speaker audio output.

■ Connecting/ Disconnecting/ Deleting a registered device using My Devices

Press the key programmed as [Menu] to enter Bluetooth My Devices Mode using the Menu Mode.

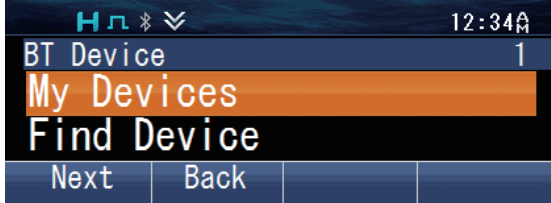

To connect a device:

- 1 Press the [□] key or the [▲] and [▼] keys to select the device to connect to.

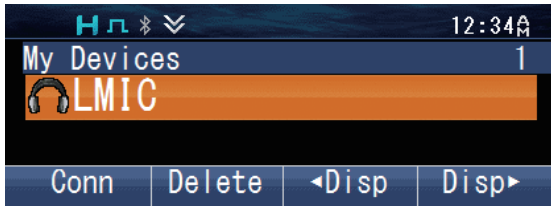

- 2 Press the [□] key to connect.

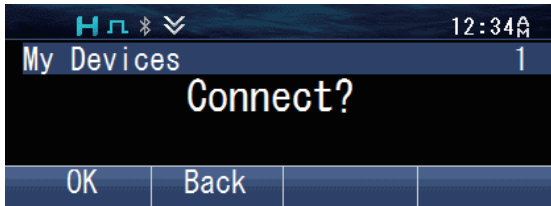

- 3 Press the [OK] key to confirm the connection.
- The LED indicator blinks in blue while the transceiver is connecting to the device, “Connecting” appears on the display.
 - “Connected” appears when the connection is established.



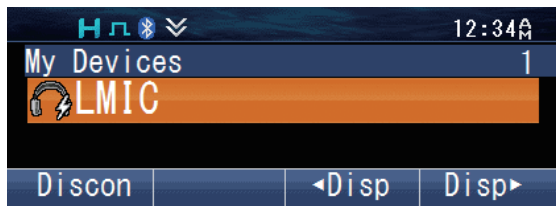

To disconnect a device:

- 1 Press the [OK] key or the [▲] and [▼] keys to select the device to disconnect.

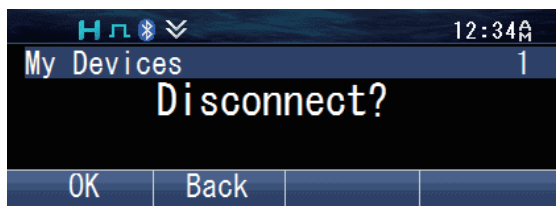

- 2 Press the [OK] key to disconnect.



- 3 Press the [OK] key to confirm the disconnection.
- The “” indicator and “Disconnected” appear on the display.

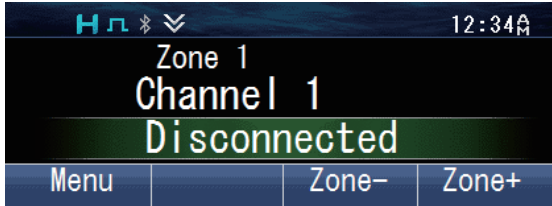

To delete a device:

Note:

- Make sure the device to be deleted has been disconnected.
-

- 1 Press the [OK] key or the [▲] and [▼] keys to select the device to delete.

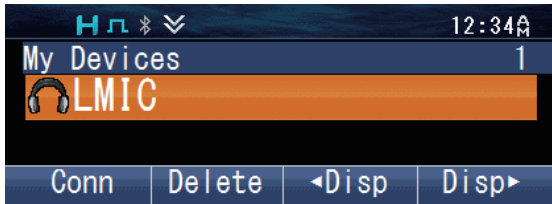

- 2 Press the [↵] key to delete.

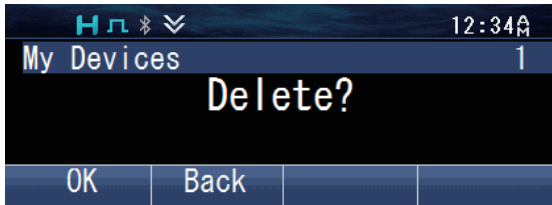

- 3 Press the [OK] key to confirm.
- The selected device will be deleted. “BT No Device” appears when there is no other registered device.

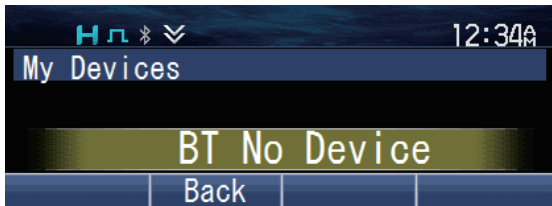

Note:

- To delete all the registered devices, press and hold the [↵] key in Step 2.
-

■ Checking the information of the devices

- 1 Press the key programmed as **[Menu]** to enter Bluetooth My Devices Mode using the Menu Mode.

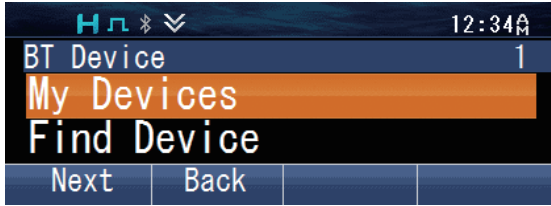

- 2 Press the [**▲**] and [**▼**] keys to select the device to display its information.

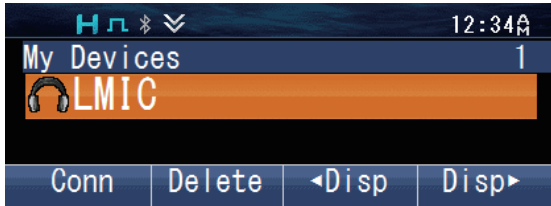

- 3 Press the [**◀**] and [**▶**] keys to switch the information display.
BT Name : The name of the Bluetooth device.
BT Address : The address of the Bluetooth device.
Class : The equipment classification of the Bluetooth device. Refer to the following table for more details.

BT Name

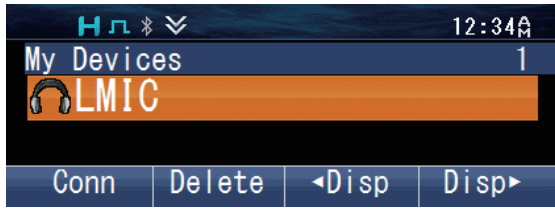

[<] key ↑ ↓ [>] key

Class

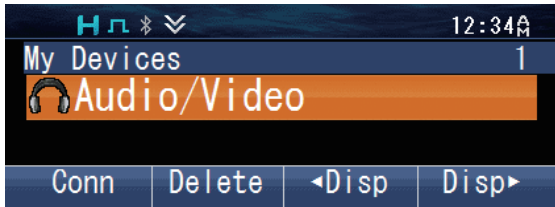

[<] key ↑ ↓ [>] key

BT Address

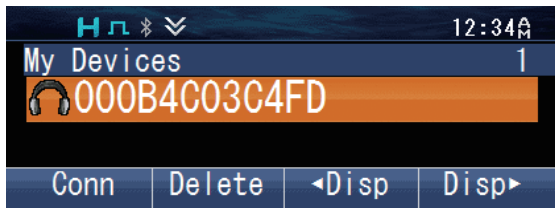

[<] key

[>] key

| Device Class | Disconnected | Connected |
|--------------|--------------|-----------|
| Audio/Video | | |
| Phone | | |
| Computer | | |
| LAN/Network | | |
| Peripheral | | |
| Imaging | | |
| Wearable | | |
| Toy | | |
| Health | | |

Note:

- You can also check the information of the devices in the Find Device mode.
 - The icons listed in the above table indicate the connection status of the Headset Profile. They are not applicable to the Serial Port Profile connection.
-

■ Switching the speaker audio output

You can switch the audio output between the speaker of the transceiver and the Bluetooth headset.

Press the key programmed as **[Bluetooth Speaker]** repeatedly to change the setting (“Off”, “Only” or “Both(BT+Radio)”).

Alternatively, press the key programmed as **[Menu]** to enter Bluetooth Speaker Mode using the Menu Mode. Press the **[▲]** and **[▼]** keys to select “Off”, “Only” or “Both(BT+Radio)”.

- Off** : Audio is output from the built-in speaker of the transceiver.
Only : Audio is output from the speaker of the Bluetooth device.
Both(BT+Radio) : Audio is output from both built-in speaker of the transceiver and speaker of the Bluetooth device.

Press the **[□]** key to confirm your selection.

NOTIFICATION DISPLAY

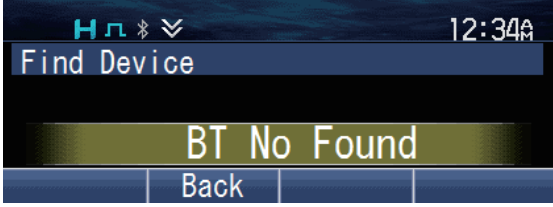
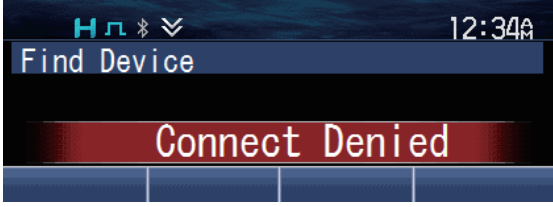
| Display | Cause |
|---|---|
|  <p>The screenshot shows a notification for 'BT Failure'. At the top, it displays 'Zone 1 Channel 1'. The main message is 'BT Failure' in large white text on a dark red background. Below the message are three buttons: 'Menu', 'Zone-', and 'Zone+'. The status bar at the top shows signal strength, battery, and the time 12:34.</p> <p>(Display for 1 second)</p> | <p>The integrated circuit (IC) which enables the Bluetooth function is not working properly.</p> |
|  <p>The screenshot shows a notification for 'BT No Found'. At the top, it displays 'Find Device'. The main message is 'BT No Found' in large white text on a dark green background. Below the message is a 'Back' button. The status bar at the top shows signal strength, battery, and the time 12:34.</p> | <p>No device is found in the Bluetooth Find Device Mode.</p> |
|  <p>The screenshot shows a notification for 'No Response'. At the top, it displays 'Find Device'. The main message is 'No Response' in large white text on a dark red background. The status bar at the top shows signal strength, battery, and the time 12:34.</p> <p>(Display for 1 second)</p> | <p>There is no response from the Bluetooth device on the request for pairing, Headset Profile (HSP) connection or Serial Port Profile (SPP) connection.</p> |
|  <p>The screenshot shows a notification for 'Connect Denied'. At the top, it displays 'Find Device'. The main message is 'Connect Denied' in large white text on a dark red background. The status bar at the top shows signal strength, battery, and the time 12:34.</p> <p>(Display for 1 second)</p> | <p>The Bluetooth device has rejected a request for pairing or Headset Profile (HSP) connection.</p> |
|  <p>The screenshot shows a notification for 'BT No Service'. At the top, it displays 'Find Device'. The main message is 'BT No Service' in large white text on a dark red background. The status bar at the top shows signal strength, battery, and the time 12:34.</p> <p>(Display for 1 second)</p> | <p>The Bluetooth device does not support Headset Profile (HSP) connection.</p> |

microSD CARD & BUILT-IN MEMORY

You can perform voice recording, voice playback and GPS Data Storage using the built-in memory or a microSD card.

Note:

- To install or remove a microSD memory card on this transceiver, please consult your dealer.

USING THE microSD CARD

Insert the microSD card into the transceiver and turn on the transceiver. The  indicator lights up on the display when the microSD card is recognized by the transceiver. Recordings and data will be stored on the microSD card.

When using the microSD card for the first time on the transceiver, it is necessary to format the card.

- All existing files on the microSD card will be deleted upon formatting. Folders for storing the recordings and data will be created in the microSD card.

Folder structure and file naming

Voice files and GPS data files are stored in their respective folders. Up to 250 files can be stored in each folder.

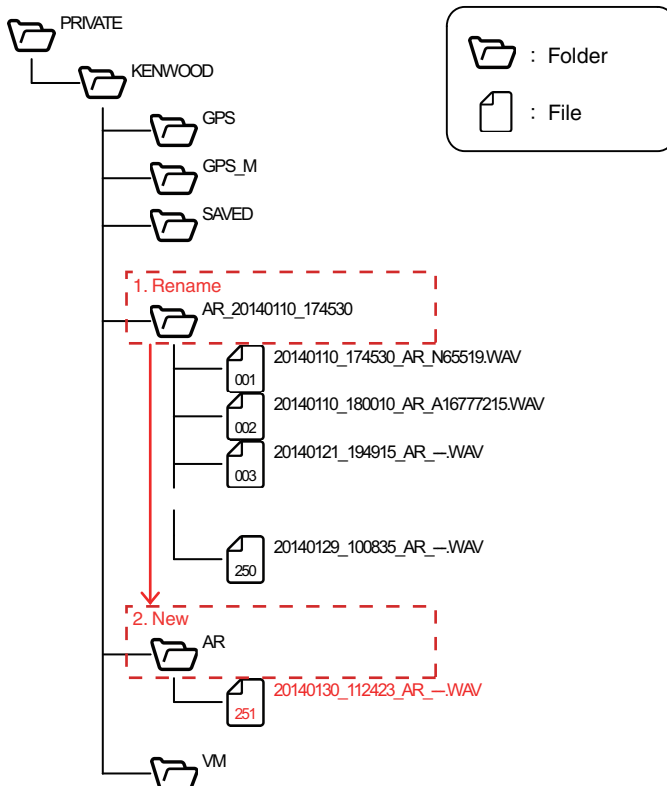

| Folder Type | Description |
|-------------|--|
| AR *1 | Stores voice files recorded using Auto Recording. |
| VM *1 | Stores voice files recorded using Voice Memo. |
| SAVED | Voice files recorded using Auto Recording and Voice Memo can be stored in this folder manually. Refer to “To save a recording” {p. 80} . |
| GPS *2 | Stores GPS data files saved using GPS Data Storage (Auto). |
| GPS_M *3 | Stores GPS data files saved using GPS Data Storage (Manual). |

- *1 If the folder has reached its maximum limit of 250 files, the current folder is automatically renamed and a new folder is created when storing the 251st file. Up to 2000 folders can be created.
- *2 Only one folder is available for storing GPS data files saved using GPS Data Storage (Auto). If the folder has reached its maximum limit of 250 files, the oldest file in the folder is deleted when storing the 251st file.
- *3 Only one folder is available for storing GPS data files saved using GPS Data Storage (Manual). Up to 2000 GPS data can be saved in a file. If the folder has reached its maximum limit of 250 files and the 250th file contains 2000 data, no further GPS data can be saved.

Files stored in each folder are automatically named.

20140110 - 174530 - AR - N65519 .WAV
 ① ② ③ ④ ⑤

① Date saved

The year, month and day the file is saved.

② Time saved

The hour, minute and second the file is saved.

③ Function

Indicates the function used to save the file.

AR : Auto Recording

VM : Voice Memo

GPS : GPS Data Storage (Auto)

GPS_M : GPS Data Storage (Manual)

④ Call origin (Auto Recording and Voice Memo only)

ID information of the call origin when recording starts. “---” is displayed when no ID information is available.

⑤ File extension

Voice files are saved as “.WAV”, and GPS data files are saved as “.TXT”.

Note:

- The date format and time format settings do not apply to the file name.
- When the built-in clock stops or the clock has not been set, the date saved ① will become “00000000” and the time saved ② will become a file number. The file number is determined as follows.
 - If there are no files in the destination folder where the file is to be saved, a file name with the file number “000001” is saved.
 - If there are files in the destination folder where the file is to be saved, a file name with the file number made up of the biggest file number of the existing files + 1 is saved.
 - The file numbers that can be used is 000001 to 009999.

■ microSD card recording time

The estimated maximum recording time for Voice Memo and Auto Recording according to the capacity of the microSD card is as follows.

| microSD Card Capacity | Estimated Recording Time (Max) |
|-----------------------|--------------------------------|
| 2 GB | 35 hours |
| 4 GB | 70 hours |
| 8 GB | 140 hours |
| 16 GB | 280 hours |
| 32 GB | 560 hours |

■ Warnings for the remaining capacity of microSD card

◆ Low SD Memory

If Low Memory Warning is enabled by your dealer, “Low SD Memory” appears on the display for 1 second when the remaining capacity of the microSD card is 10 % or less.

◆ Memory Full

“Memory Full” appears on the display for 1 second under any of the following conditions.

| | |
|---------------------------|--|
| Auto Recording | When any of the following conditions is satisfied. <ul style="list-style-type: none">• The remaining capacity of the microSD card is less than 2 times the Maximum Recording Length.• When the First-in First-out Deletion function is disabled and there are 250 files in the 2000th folder. |
| Voice Memo | When any of the following conditions is satisfied. <ul style="list-style-type: none">• The remaining capacity of the microSD card is less than 2 times the maximum recording time of 10 minutes.• When the First-in First-out Deletion function is disabled and there are 250 files in the 2000th folder. |
| GPS Data Storage (Auto) | When any of the following conditions is satisfied. <ul style="list-style-type: none">• The remaining capacity of the microSD card is less than 43 MB when there is no GPS data file in the GPS folder with the same date as the current saving date.• The remaining capacity of the microSD card is less than 128 KB when there is a GPS data file in the GPS folder with the same date as the current saving date. |
| GPS Data Storage (Manual) | When all the following conditions are satisfied. <ul style="list-style-type: none">• NMEA of any of the Record Format (Manual/Auto) is enabled.• The Save GPS Data key, GPS Position Display key, Menu key for executing Save GPS Data or Menu key for executing GPS Position Display is configured.• The remaining capacity of the microSD card is less than 1 KB. Or there is no GPS data file in the GPS_M folder with the same date as the current saving date and there are 250 GPS data files in the folder. |

■ Formatting the microSD card

- 1 Press the key programmed as **[Format SD Card]** to enter Format SD Card mode.
 - “You will lose all data on the card.” appears on the display. Press the **[OK]** key.
- 2 Select “Start” and press the **[OK]** key to format the card.
 - When formatting is complete, the **[SD]** indicator lights up and “Complete” appears on the display. Folders for storing the recorded files are created on the microSD card.

Auto Recording

Auto Recording records and retains your last conversation, allowing you to catch what you may have missed hearing during the conversation.

If activated, the auto recording function will continuously record all transmitted and received signals to the built-in memory or microSD card according to the maximum recording length set.

- The **[RECORDING]** indicator blinks while recording is in progress.

When recording is made to the built-in memory, the backup timing of the voice recording varies according to the First-in First-out Deletion setting. If First-in First-out Deletion is enabled, the recording is backed up when the transceiver is turned off using the **Power** switch. If disabled, the recording is backed up each time a recording is made. For details on the First-in First-out Deletion function, consult your dealer.

Note:

- Recording stops when the maximum recording length is reached.
 - If the First-in First-out Deletion function is disabled, new recordings cannot be made when the memory in the built-in memory or microSD card is full. “Memory Full” appears on the display for 1 second.
 - If the First-in First-out Deletion function is enabled and recording is made to the built-in memory, the transceiver turns off without backing up the recording when it is turned off in the following situations:
 - When the battery runs out
 - When the power cable is unplugged
 - You can play back the voice recording in Playback mode, or delete the recording if necessary.
 - If Auto Recording is used concurrently with the GPS Data Storage function, the beginning of the audio recorded by Auto Recording may be clipped off.
-

Voice Memo

Voice Memo allows you to record audio near the transceiver manually. Maximum recordable time per Voice Memo is 10 minutes. The voice files are stored on the microSD card.

The audio input from the microphone selected in Control Head Mic Input is recorded.

- 1 Press the key programmed as **[Voice Memo]** to enter Voice Memo mode. Alternatively, press the key programmed as **[Menu]** to enter Voice Memo mode using the Menu Mode.
 - Recording starts on the transceiver.
 - The transceiver will exit Voice Memo mode and stop the recording automatically after 10 minutes into the recording.
- 2 To stop the recording manually, press the **[OK]** key.

Note:

- Recording does not start when the key programmed as **[Voice Memo]** is pressed under the following conditions.
 - Recognition of the microSD card by the transceiver is not complete.
 - Formatting of microSD card is in progress.
 - Deleting of voice files is in progress.
 - If Voice Memo is used concurrently with the GPS Data Storage function, the beginning of the audio recorded by Voice Memo may be clipped off.
-

GPS Data Storage

GPS data can be stored either automatically in the built-in memory and microSD card or manually at your preferred timing in the microSD card.

■ GPS Data Storage (Auto)

The GPS data is stored temporarily in the transceiver RAM at every GPS Storage Interval from the GPS unit. The data will be written to the built-in memory and microSD card when more than three pieces of data are collected. The stored GPS data in the built-in memory can be sent from the transceiver via DMR/ NXDN Air Protocol or can be read on a PC.

Up to 7000 GPS data can be written to the built-in memory. In the case of microSD card, a maximum of 250 days of GPS data or the microSD card capacity allowable quantity can be written to it. Record Format (Manual/Auto) must be configured in order to write a GPS data to the microSD card. For more details, consult your dealer.

■ GPS Data Storage (Manual)

The GPS data can be manually stored in the microSD card using one of the key operations below.

- Press the key programmed as **[Save GPS Data]**.
- Press the key programmed as **[GPS Position Display]** to enter the GPS Position Display mode, then press **[□]**.
- Press the key programmed as **[Menu]** to enter Menu Mode to execute Save GPS Data or GPS Position Display.

A maximum of 250 days of GPS data or the microSD card capacity allowable quantity can be written to the microSD card. However, the data is not stored under the following conditions even when the key is pressed.

- When there is no GPS positioning.
- When the GPS function of the built-in GPS receiver is turned off.
- When the microSD card is not recognized properly.
- When the Memory Full conditions for GPS Data Storage (Manual) are satisfied. {p. 77}

Note:

- The data saved can be displayed using the GPS Position Display function.
-

Playback

You can play back the voice recordings recorded using Auto Recording and Voice Memo.

- 1 Press the key programmed as **[Playback]** to enter Playback mode.
Alternatively, press the key programmed as **[Menu]** to enter Playback mode using the Menu Mode.
 - If a microSD card is not inserted in the transceiver, the voice recordings are listed on the display. Proceed to step 4.
 - If a microSD card is inserted in the transceiver, the Saved (📁), Auto Recording (📁) and Voice Memo (📁) folders where the voice recordings are stored are displayed. Only the folder with files stored in it is displayed.
- 2 Press the [▲] and [▼] keys to select the Auto Recording or Voice Memo folder, then press the [□] key.
 - The subfolders in the folder are listed on the display.
- 3 Press the [▲] and [▼] keys to select a folder, then press the [□] key.
 - The voice recordings in the folder are listed on the display.
- 4 Press the [▲] and [▼] keys to move up and down the list.
- 5 Press the [□] key to play back.
 - After playing back a recording, the transceiver will automatically play the next recording until the last recording on the list is played.
 - To pause or resume playback, press the [□] key.
 - To skip to the next or previous recording, press the [◀]/[▶] key. Press and hold the key to fast-forward or rewind.

■ To play back the last recording directly

Press the key programmed as **[Playback (Last Recording)]** to play back the latest audio data recorded using the Auto Recording function.

■ To save a recording

- 1 Press the [○] key while the voice recording list is displayed. Then press the [□] key.
 - A confirmation message appears on the display.
- 2 Press the [□] key to save.
 - The file is saved in the Saved folder.

■ To delete a recording

- 1 Press the [○] key while the voice recording list is displayed. Then press the [↵] key.
 - A confirmation message appears on the display.
- 2 Press the [□] key to delete.





























■ To delete all recordings











- 1 Press the [○] key while the voice recording list is displayed. Then press and hold the [↵] key.
 - A confirmation message appears on the display.
- 2 Press the [□] key to delete.

■ To delete a folder

- 1 Press the [O] key while the folder list is displayed. Then press the [↵] key.
 - A confirmation message appears on the display.
- 2 Press the [⇩] key to delete.

INDICATOR LIST

| Indicator | Description |
|---|--|
|  | Displays the signal strength. |
|  | The channel is using high transmit power. |
|  | The channel is using medium transmit power. |
|  | The channel is using low transmit power. |
|  | In Digital mode (Digital Channel) |
|  | In Analog mode (Analog Channel) |
|  | In Digital mode (Mixed Channel) |
|  | In Analog mode (Mixed Channel) |
|  | The Bluetooth function is activated. Blinks in the process of turning on Bluetooth. |
|  | Connected to a Bluetooth device. |
|  | The GPS position is determined. Blinks when the GPS is unable to determine the position. |
|  | Non-priority Scan or Voting/ Site Roaming is in progress. Blinks when the scan is paused. |
|  | Priority Scan is in progress. Blinks when the scan is paused. |
|  | Indicates Priority channel 1 or Priority Monitor ID 1. |
|  | Indicates Priority channel 2 or Priority Monitor ID 2. |
|  | Indicates Priority Monitor ID 3. |
|  | Indicates Priority Monitor ID 4. |
|  | The current channel is added to the scanning sequence. |
|  | The current zone is added to the Multi-Zone scanning sequence. |
|  | The Scrambler function is activated. |
|  | The Encryption function is activated. Blinks when receiving an encrypted carrier. |
|  | The Encryption (AES) function is activated. Blinks when receiving an encrypted carrier. |
|  | The Encryption (DES) function is activated. Blinks when receiving an encrypted carrier. |
|  | The Enhanced Encryption function is activated. Blinks when receiving an encrypted carrier. |
|  | The Talk Around function is activated. |
|  | The Monitor or Squelch Off function is activated. |
|  | The External Speaker is activated. |
|  | The External Speaker (Internal + External) is activated. |

| Indicator | Description |
|---|--|
|  | The Noise Reduction function is activated. Blinks when Noise Reduction is functioning. |
|  | Blinks when an incoming call matches your Optional Signaling. |
|  | A message is stored in the memory. Blinks when a new message is received. |
|  | All stored Task Requests have been read. Blinks when a new Task Request is received and unread. |
|  | The microSD memory card is recognized. |
|  | The microSD memory card is not recognized. |
|  | The Site Lock function is activated. |
|  | The System Lock is activated. |
|  | The Broadcast Call function is activated. |
|  | The Surveillance function is activated. |
|  | Appears when the selected group is programmed as telephone IDs. Blinks during Auto Telephone search. |
|  | The Tactical Zone is activated. |
|  | The Horn Alert function is activated. |
|  | The Public Address function is activated. |
|  | The auxiliary port A is activated. |
|  | The auxiliary port B is activated. |
|  | The auxiliary port C is activated. |
|  | The Intercom function is activated. |
|  | The Lone Worker function is activated. |
|  | The OVCM function is activated. |
|  | The Comander function is activated. |
|  | The Operator Selectable Tone function is activated. |
|  | Blinks during Auto Recording. |
|  | The VOX function is activated. |
|  | The Key Lock function is activated. |

Note:

- The function indicators are displayed in color when the Color Scheme has been set to “Full Color”. {p. 52}

KENWOOD

© 2018 JVCKENWOOD Corporation