

KENWOOD

ProTalk DIGITAL

TK-3601D

UHF DIGITAL TRANSCEIVER

USER MANUAL



JVCKENWOOD Corporation

B5A-2559-00/00 (E)

CONTENTS

ORIENTATION	4
BUTTONS AND CONTROLS.....	4
DISPLAY	6
BASIC OPERATION	8
POWER ON	8
ADJUST THE VOLUME.....	8
SELECT A ZONE	8
SELECT A CHANNEL.....	9
MAKE A CALL.....	9
RECEIVE VOICE.....	9
CONTINUE CALLING	9
POWER OFF.....	9
CHANNEL MENU MODE	10
QT/ DQT (ANALOGUE).....	11
COMMON ID (DIGITAL).....	13
PRIVACY TALK (SCRAMBLER).....	15
VOICE OPERATED TRANSMISSION (VOX)	17
FRONT PANEL PROGRAMMING MODE	18
FUNCTION SETTING MODE	20
SETTING TARGET.....	21
BATTERY SAVER	22
AUDIO EQUALIZER (RX AUDIO RESPONSE).....	23
AUDIO EQUALIZER (TX AUDIO RESPONSE)	24
SQUELCH LEVEL.....	25
MICROPHONE SENSE	26
EXTERNAL MICROPHONE SENSE.....	27
MICROPHONE TYPE	28
EARPHONE MODE	29
VOX SETUP	30
BUTTON ASSIGNMENT MODE.....	33
BUTTON LOCK	35
CALLING ALERT (ANALOGUE)	35
HOME CHANNEL	35
MAINTENANCE DISPLAY	36
MONITOR	37
SQUELCH OFF (ANALOGUE)	37

SCAN.....38
SECOND CHANNEL40
VOLUME ATTENUATION.....42
ZONE.....42
BACKGROUND OPERATIONS..... 43
 BATTERY LEVEL INDICATOR43
RESETTING THE TRANSCEIVER..... 44
OPTIONS..... 45
 INSTALLING / REMOVING THE KBH-2246
TROUBLESHOOTING GUIDE 47
SPECIFICATIONS 48

ORIENTATION

BUTTONS AND CONTROLS

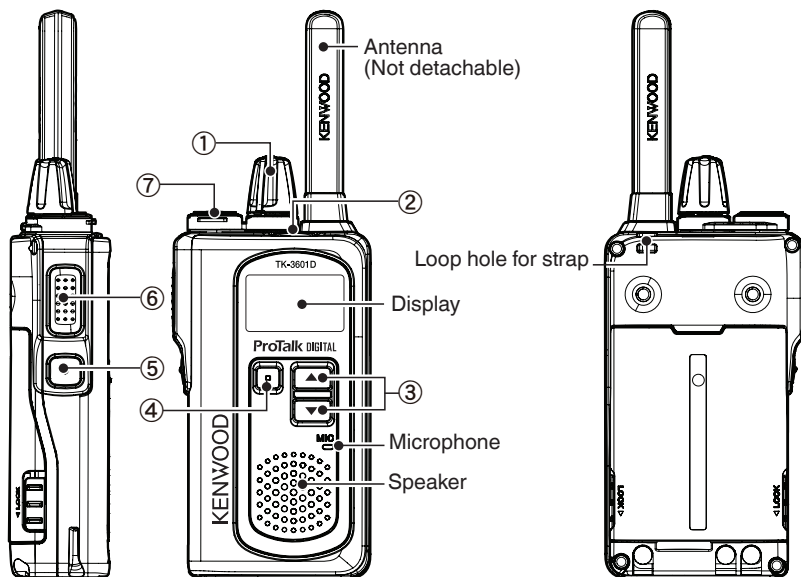

① Power switch/ Volume control

Turn clockwise to switch the transceiver ON. Rotate to adjust volume level. Turn fully counterclockwise, until click sound, to switch transceiver OFF.

② LED indicator

For the LED indicator status {p.9}.

③ ▲ (Up) / ▼ (Down) buttons

Press to change channel, select menu in setting mode or to perform other functions.

④ Menu button

Press to activate its programmable function.

Default Function		Reference Page
Press	Channel Menu	10
Press and hold	Button Lock	35

- For function descriptions and details on how to change the function of the **Menu** button. Refer to “BUTTON ASSIGNMENT MODE” {p. 33}.

⑤ **Side button**

Press to activate its programmable function.

Default Function		Reference Page
Press	None (No function)	–
Press and hold	Zone	8

- For function descriptions and details on how to change the function of the **Side** button. Refer to “BUTTON ASSIGNMENT MODE” {p. 33}.

⑥ **PTT (Push to Talk) switch**

Press and hold, then speak into the microphone to transmit.

⑦ **SP/ MIC jack**

Insert the speaker/ microphone or headset plug into this jack.

DISPLAY

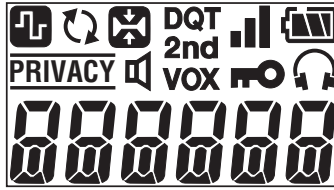

Indicator	Description
	Appears while transmitting / receiving. When receiving: Displays the signal strength. : Strong : Sufficient : Weak
	Appears the battery power. :High :Sufficient :Low (Blinks) :Very Low
	Appears when channel type is configured to Digital.
DQT	Appears when the channel is configured with a DQT code.
	Appears when the Scan is activated. Blinks when the scan is paused.
	Appears when the Compander is activated.
<u>PRIVACY</u>	Appears when the Scrambler function is activated.
VOX	Appears when the VOX is activated.
	Appears when the Button lock is activated.
	Appears when the Earphone mode is activated.
2nd	Appears when the Second Scan is activated. Blinks when Second Scan function is paused and resting on Second Channel.
	Appears when the Monitor open or Squelch off is activated.

Font Display

Because the display is segmented, letters and numbers are displayed as shown below.

"X" is not used in this transceiver.

A	B	C	D	E	F	G	H	I	J
A	b	c	d	E	F	G	H	I	J
K	L	M	N	O	P	Q	R	S	T
K	L	m	n	o	P	q	R	S	t
U	V	W	Y	Z	-	>			
U	v	w	y	z	-	>			
0	1	2	3	4	5	6	7	8	9
0	1	2	3	4	5	6	7	8	9

BASIC OPERATION

POWER ON

Switch the transceiver power ON by turning the **Power switch/ Volume control** knob clockwise.

- A confirmation tone sounds, the LCD lights up momentarily, then the current zone and channel number are displayed.

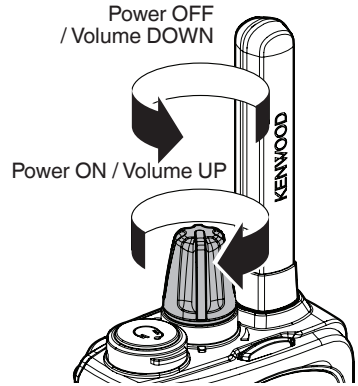
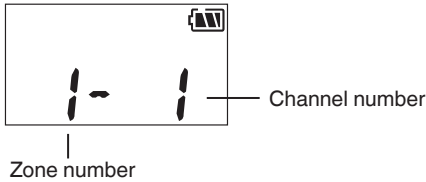

ADJUST THE VOLUME

Set your desired volume level by rotating the **Power switch/ Volume control** knob.

- Clockwise increases the volume and counterclockwise decreases the volume.

Note:

- ◆ To adjust the volume using background noise as a reference in Analogue mode, use the Squelch off Function.

SELECT A ZONE

Press and hold the **Side** button for 1 second to change Zone 1, Zone 2, and Zone 3.

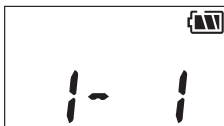

➔
Press and hold
Side button

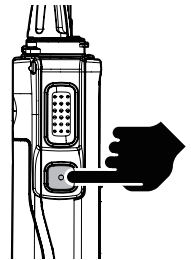

SELECT A CHANNEL

Select a channel by pressing the ▲ or ▼ button.

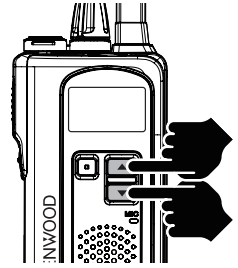
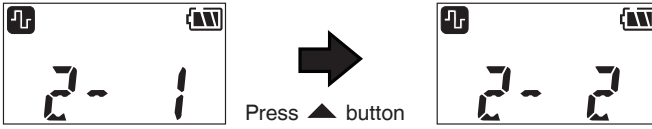

MAKE A CALL

To make a call, press and hold the **PTT** switch, then speak around the microphone area using your normal speaking voice. Release the **PTT** switch to receive.

- Hold the microphone approximately 1.5 inches (3 to 4 cm) from your lips.

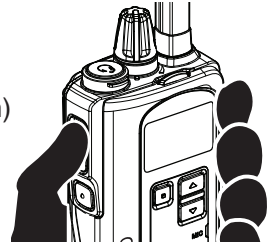

RECEIVE VOICE

A signal strength icon is appeared on the display and the LED lights in green. When the other party transmits it, you hear the voice of the other party.

CONTINUE CALLING

It alternately transmits and receives.

After the other party's call is over, press **PTT** switch and transmit.

POWER OFF

After use, turn off the power. To switch the transceiver power OFF, turn the **Power switch/ Volume control** knob fully counterclockwise, until a click sounds.

LED INDICATOR STATUS

Indicator Color	Meaning
Red - solid	Transmitting.
Green - solid	Receiving a signal. Squelch Off function is activated.
Red - blinking	When the battery low power warning is activated.

CHANNEL MENU MODE

This transceiver allows you to reprogram each of the channels with different frequencies and / QT/DQT (Analogue)/ Common ID (Digital)/ Scrambler (Analogue)/ Compander (Analogue)/ VOX settings.

1 Press the **Menu** button.

- Displays the setting items of Channel Menu mode.



2 Press the ▲ or ▼ button to select your desired settings.



3 Press the **Menu** button then press the ▲ or ▼ button to select your desired value for the setting.



4 Press the **Menu** button to exit the selection.

5 Press the **PTT** switch or the **Side** button to exit Channel Menu mode.

Setting item list

Display	Name	Settings	Default	Reference page
9t d9t	QT/ DQT * ¹	OFF/ 01 ~ 38	–	11
Id	Common ID * ²	1 ~ 255	–	12
5CP	Scrambler * ¹	OFF/ ON	OFF	15
Compd	Compander * ¹	OFF/ ON	OFF	16
Vo	VOX	OFF/ ON	OFF	17

*¹: It can be set when Channel type is Analogue.

*²: It can be set when Channel type is Digital.

Note:

- ◆ You can also change the channel menu setting of all channels at once. Refer to "SETTING TARGET" {p.21}.

QT/ DQT (ANALOGUE)

QT (Quiet Talk) and DQT (Digital Quiet Talk) are functions that reject signals from undesired parties that are using the same channel as you. You will hear audio from the speaker only when you receive a signal that contains a tone or code matching the one setup on the channel you are using. Likewise, when you transmit on a channel setup with QT or DQT, the receiving station must have a matching tone or code in order to hear your signal.

You can select a tone or code for each channel. After changing the QT/ DQT setting, confirm that the other members in your group have selected the same tone or code.

The table below lists the default channel settings.

Channel Number	Zone 1		
	Frequency (MHz)	Table No.	QT/DQT
1	446.006250	10	94.8 Hz
2	446.093750	8	88.5 Hz
3	446.031250	13	103.5 Hz
4	446.068750	5	79.7 Hz
5	446.043750	17	118.8 Hz
6	446.018750	18	123.0 Hz
7	446.081250	19	127.3 Hz
8	446.056250	7	85.4 Hz
9	446.006250	14	107.2 Hz
10	446.093750	15	110.9 Hz
11	446.031250	16	114.8 Hz
12	446.068750	6	82.5 Hz
13	446.043750	27	D132N
14	446.018750	28	D155N
15	446.056250	29	D134N
16	446.081250	30	D243N

QT/DQT Table

Table No.	QT frequency [Hz] DQT Code	Table No.	QT frequency [Hz] DQT Code	Table No.	QT frequency [Hz] DQT Code	Table No.	QT frequency [Hz] DQT Code
1	67.0	11	97.4	21	136.5	31	D311N
2	71.9	12	100.0	22	141.3	32	D346N
3	74.4	13	103.5	23	146.2	33	D315N
4	77.0	14	107.2	24	151.4	34	D351N
5	79.7	15	110.9	25	156.7	35	D423N
6	82.5	16	114.8	26	162.2	36	D664N
7	85.4	17	118.8	27	D132N	37	D431N
8	88.5	18	123.0	28	D155N	38	D723N
9	91.5	19	127.3	29	D134N		
10	94.8	20	131.8	30	D243N		

To change the QT/DQT settings:

- 1 Enter the Channel Menu mode {p.10}.
- 2 Press the ▲ or ▼ button to select “QT DQT”.



- 3 Press the **Menu** button then press the ▲ or ▼ button to select your desired QT/DQT table number for the channel.
 - The values range from 1 to 26 for QT tones, then proceed to 27 to 38 for DQT codes. When selecting a DQT code, the **DQT** icon appears on the display.

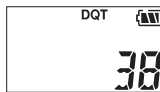

- Select “OFF” to turn off both QT and DQT.
- 4 Press the **Menu** button to exit the selection, then press the **PTT** switch or the **Side** button to exit the Channel Menu mode.

COMMON ID (DIGITAL)

Common ID is a signaling system designed for Digital communications. When a channel is setup with a Common ID, squelch will only open when a call containing a matching Common ID is received. If a call containing a different Common ID is made on the same channel you are using, you will not hear the call. This allows you to ignore (not hear) calls from another parties who are using the same channel.

The table below lists the default channel settings.

Channel Number	Zone 2		Zone 3	
	Frequency (MHz)	Common ID	Frequency (MHz)	Common ID
1	446.103125	1	446.003125	1
2	446.109375	2	446.009375	2
3	446.115625	3	446.015625	3
4	446.121875	4	446.021875	4
5	446.128125	5	446.028125	5
6	446.134375	6	446.034375	6
7	446.140625	7	446.040625	7
8	446.146875	8	446.046875	8
9	446.153125	9	446.053125	9
10	446.159375	10	446.059375	10
11	446.165625	11	446.065625	11
12	446.171875	12	446.071875	12
13	446.178125	13	446.078125	13
14	446.184375	14	446.084375	14
15	446.190625	15	446.090625	15
16	446.196875	16	446.096875	16

To change the Common ID settings:

- 1 Enter the Channel Menu mode {p.10}.
- 2 Press the ▲ or ▼ button to select “*Id*”.



- 3 Press the **Menu** button then press the ▲ or ▼ button to select your desired Common ID.



- The values range from 1 to 255.
 - If you set Common ID to 255, you can call to all Common ID transceivers.
- 4 Press the **Menu** button to exit the selection, then press the **PTT** switch or the **Side** button to exit the Channel Menu mode.

PRIVACY TALK (SCRAMBLER)

When the Channel Type is Analogue, whereas the QT and DQT functions allow you to ignore unwanted calls, Privacy Talk allows you to hold a conversation in complete privacy. When this function is activated, any other party that is listening to your channel will be unable to understand your conversation.

- 1 Enter the Channel Menu mode {p.10}.
- 2 Press the ▲ or ▼ button to select “SCP”.



- 3 Press the **Menu** button then press the ▲ or ▼ button to select your desired value.

off	OFF	The Scrambler function is deactivated.
on	ON	The Scrambler function is activated.

- The PRIVACY icon appears on the display when “ON” is selected.
- 4 Press the **Menu** button to exit the selection, then press the **PTT** switch or the **Side** button to exit the Channel Menu mode.

COMPANDER

The Comander (compressor/expander) allows higher clarity of sound, reducing excessive noise. When activated, transmitted sound are compressed before being sent and received sound are expanded when they arrive.

This function is activated when Channel type is Analogue.

- 1 Enter the Channel Menu mode {p.10}.
- 2 Press the ▲ or ▼ button to select “[mPd”.



- 3 Press the **Menu** button then press the ▲ or ▼ button to select your desired value.

<i>off</i>	OFF	The Comander function is deactivated.
<i>on</i>	ON	The Comander function is activated.

- The  icon appears on the display when “ON” is selected.
- 4 Press the **Menu** button to exit the selection, then press the **PTT** switch or the **Side** button to exit the Channel Menu mode.

VOICE OPERATED TRANSMISSION (VOX)

- 1 Connect a headset to the transceiver.
 - The VOX function does not activate when a headset is not connected to the SP/MIC jack of the transceiver.
- 2 Enter the Channel Menu mode {p.10}.
- 3 Press the ▲ or ▼ button to select “*u o*”.



- 4 Press the **Menu** button then press ▲ or ▼ to select “*on*” (VOX function activate).

<i>off</i>	OFF	The VOX function is deactivated.
<i>on</i>	ON	The VOX function activated.

- 5 To transmit, speak into the headset.
 - You do not need to press the **PTT** switch; the transceiver automatically detects your voice and begins transmitting. The LED lights red.
 - You can set the VOX Type, VOX Gain Level, and VOX Delay Time. Refer to “VOX SETUP” {p. 30}.
- 6 Press the **Menu** button to exit the selection, then press the **PTT** switch or the **Side** button to exit the Channel Menu mode.

FRONT PANEL PROGRAMMING MODE

You can change the channel frequency for Zone 1, Zone 2, and Zone 3.

Frequency List

Analogue Channel		Digital Channel			
Table No.	Frequency (MHz)	Table No.	Frequency (MHz)	Table No.	Frequency (MHz)
A01	446.006250	D01	446.103125	D17	446.003125
A02	446.018750	D02	446.109375	D18	446.009375
A03	446.031250	D03	446.115625	D19	446.015625
A04	446.043750	D04	446.121875	D20	446.021875
A05	446.056250	D05	446.128125	D21	446.028125
A06	446.068750	D06	446.134375	D22	446.034375
A07	446.081250	D07	446.140625	D23	446.040625
A08	446.093750	D08	446.146875	D24	446.046875
A09	446.106250	D09	446.153125	D25	446.053125
A10	446.118750	D10	446.159375	D26	446.059375
A11	446.131250	D11	446.165625	D27	446.065625
A12	446.143750	D12	446.171875	D28	446.071875
A13	446.156250	D13	446.178125	D29	446.078125
A14	446.168750	D14	446.184375	D30	446.084375
A15	446.181250	D15	446.190625	D31	446.090625
A16	446.193750	D16	446.196875	D32	446.096875

To change the operating frequency of a channel:

- 1 With the transceiver power OFF, press and hold the **Menu** button while turning the transceiver power ON.
- 2 Press the ▲ or ▼ button to select your desired zone and channel.



- Press the ▲ button to change as follows.

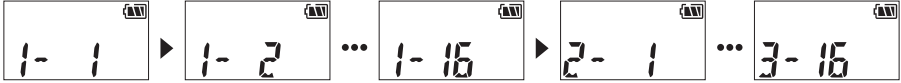

- Press the ▼ button to change in reverse order.

- 3 Press the **Menu** button then press the ▲ or ▼ button to select the frequency table number or OFF (skip channel) for the channel.



- 4 Press the **Menu** button to exit the selection, then press the **PTT** switch or the **Side** button to exit the Front Panel Programming mode.

Note:

- ◆ You can mix analogue and digital table numbers in the same zone.
 - ◆ You cannot set all channels (Zone 1 - Channel 1 to Zone 3 - Channel 16) to OFF.
 - ◆ When Channel set for Second Channel is set to OFF, Second Channel function will also be OFF {p.40}.
-

FUNCTION SETTING MODE

Many functions on this transceiver are selected or configured through the Menu.

- 1 With the transceiver power OFF, press and hold the **Menu** and ▲ buttons while turning the transceiver power ON.
- 2 Press the ▲ or ▼ button to select your desired Setting menu.



- 3 Press the **Menu** button then press the ▲ or ▼ button to select your desired value.
- 4 Press the **Menu** button to exit the selection.
- 5 Press the **PTT** switch or the **Side** button to exit the Function Setting mode.

Setting Menu LIST

Display	Name	Analogue	Digital	Settings	Default	Ref. Page
Side	Button Assignment [Side]	✓	✓	Refer to the Functions list	Zone	33
Menu	Button Assignment [Menu]	✓	✓	Refer to the Functions list	Channel Menu	33
2nd 1	Second Channel Zone 1	✓	✓	OFF/ 1 ~ 16	OFF	40
2nd 2	Second Channel Zone 2	✓	✓	OFF/ 1 ~ 16	OFF	40
2nd 3	Second Channel Zone 3	✓	✓	OFF/ 1 ~ 16	OFF	40
mn tG	Setting Target	✓	✓	CH/ ALL	CH	21
b SAVE	Battery Saver	✓	✓	OFF/ Short/ Medium/ Long	OFF	22
EQ P	RX Audio Equalizer		✓	Low Boost/ Flat / High Boost	Flat	23
EQ t	TX Audio Equalizer		✓	Low Boost/ Flat / High Boost	Flat	24
SqL	Squelch Level	✓		0/ 1/ 2/ 3	2	25
miC	Microphone Sense	✓	✓	-20 dB ~ 6 dB	0 dB	26
E miC	External Microphone Sense	✓	✓	-20 dB ~ 6 dB	0 dB	28

Display	Name	Analogue	Digital	Settings	Default	Ref. Page
m tYPE	Microphone Type		✓	OFF/ 1 ~ 6	1	28
EARPHONE	Earphone Mode	✓	✓	OFF/ ON	OFF	29
VOX	VOX Type	✓	✓	Normal/ Semi VOX	Normal	30
VOX GAIN	VOX Gain Level	✓	✓	1 ~ 10	5	31
VOX DELAY	VOX Delay Time	✓	✓	0.1/ 0.3/ 0.5/ 1.0/ 1.5/ 3.0 sec	0.5 sec	32

SETTING TARGET

You can choose whether to apply channel menu settings for the current channel or all channels.

- 1 Enter the Function Setting mode {p.20}.
- 2 Press the ▲ or ▼ button to select “m t”.

- 3 Press the **Menu** button then press the ▲ or ▼ button to select your desired value.

CH	CH	Set to current channel.
ALL	ALL	Set to all channels.

- 4 Press the **Menu** button to confirm the selection, then press the **PTT** switch or the **Side** button to exit the Function Setting mode.

Note:

- ◆ “Setting Target” is displayed when [**Channel Menu**] is set in “BUTTON ASSIGNMENT MODE” {p.33}.
-

BATTERY SAVER

This transceiver has been designed to give you the most out of your battery power. The battery saver function decreases the amount of power used when a signal is not being received and no operations are being performed.

While using the transceiver, battery saver will automatically switch ON after 5 seconds have elapsed with no operations or received calls. Operating the transceiver or receiving a call will switch this feature OFF until 5 seconds of non-operation occurs again.

To turn this function on or off:

1 Enter the Function Setting mode {p.20}.

2 Press the ▲ or ▼ button to select “b SAVE”.



3 Press the **Menu** button then press the ▲ or ▼ button to select your desired value.

<i>off</i>	OFF	The Battery Saver function is deactivated.
<i>5</i>	Short	The Battery Saver function is activated and checks the presence or absence of the signal at 240 ms intervals.
<i>m</i>	Medium	The Battery Saver function is activated and checks the presence or absence of the signal at 560 ms intervals.
<i>L</i>	Long	The Battery Saver function is activated and checks the presence or absence of the signal at 800 ms intervals.

4 Press the **Menu** button to confirm the selection, then press the **PTT** switch or the **Side** button to exit the Function Setting mode.

Note:

◆ While the Battery Saver is operating, the beginning of the received voice may be cut off.

AUDIO EQUALIZER (RX AUDIO RESPONSE)

This setting item is function for Digital communications. Received sound quality will change depending on the characteristics of the other side's use environment, voice characteristics, microphone, external connection equipment and so on. By using this function, you can adjust the received sound quality according to usage and preferences.

- 1 Enter the Function Setting mode {p.20}.
- 2 Press the ▲ or ▼ button to select “EQ P”.



- 3 Press the **Menu** button then press the ▲ or ▼ button to select your desired value.

Low	Low Boost	It suppresses the high range of voice, enriching the low range. It will be calm and natural sound quality.
FLAt	Flat	It becomes standard sound quality.
HIGH	High Boost	It emphasize the high range of the voice. It is a clear quality sound quality that emphasizes listening to conversation reliably.

- 4 Press the **Menu** button to confirm the selection, then press the **PTT** switch or the **Side** button to exit the Function Setting mode.

AUDIO EQUALIZER (TX AUDIO RESPONSE)

This setting item is function for Digital communications. Transmission sound quality changes due to the characteristics of the environment using the transceiver, voice characteristics, microphone and external connection equipment. By using this function, you can adjust the transmission sound quality according to usage and preferences.

- 1 Enter the Function Setting mode {p.20}.
- 2 Press the ▲ or ▼ button to select “EQ E”.



- 3 Press the **Menu** button then press the ▲ or ▼ button to select your desired value.

Low	Low Boost	It suppresses the high range of voice, enriching the low range. It will be calm and natural sound quality.
FLAt	Flat	It becomes standard sound quality.
HiGH	High Boost	It emphasize the high range of the voice. It is a clear sound quality that emphasizes listening to conversation reliably.

- 4 Press the **Menu** button to confirm the selection, then press the **PTT** switch or the **Side** button to exit the Function Setting mode.

SQUELCH LEVEL

You can adjust the default squelch level of the transceiver.

- 1 Enter the Function Setting mode {p.20}.
- 2 Press the ▲ or ▼ button to select “59L”.



- 3 Press the **Menu** button then press the ▲ or ▼ button to select your desired value.

0~3	0 ~ 3	If you want to receive weak signal, decrease Squelch Level, and if unnecessary signal exist, increase Squelch Level.
-----	-------	--

Note:

- ◆ In digital operation, Squelch Level is fixed at level 1.
-

- 4 Press the **Menu** button to confirm the selection, then press the **PTT** switch or the **Side** button to exit the Function Setting mode.

MICROPHONE SENSE

You can adjust the sensitivity level of the transceiver microphone. It can be changed in 2 dB steps.

To select the Microphone Sense:

- 1 Enter the Function Setting mode {p.20}.
- 2 Press the ▲ or ▼ button to select “m I L”.



- 3 Press the **Menu** button then press the ▲ or ▼ button to select your desired value.

L -20db n 0db H 6db	-20dB.(low sensitivity) ~ 0dB (normal) ~ 6dB(high sensitivity)	The sensitivity decreases as the "-" number increases. 0 dB is the standard sensitivity. The sensitivity increases as the number increases.
---------------------------	---	---

- 4 Press the **Menu** button to confirm the selection, then press the **PTT** switch or the **Side** button to exit the Function Setting mode.

EXTERNAL MICROPHONE SENSE

You can adjust the sensitivity level of the external microphone. It can be changed every in 2 dB steps.

To select the External Microphone Sense:

- 1 Enter the Function Setting mode {p.20}.
- 2 Press the ▲ or ▼ button to select “E MIC”.



- 3 Press the **Menu** button then press the ▲ or ▼ button to select your desired value.

L -20db n 0db H 6db	-20dB(low sensitivity) ~ 0dB(normal) ~ 6dB(high sensitivity)	The sensitivity decreases as the number of "-" increases. 0 dB is the standard sensitivity. The sensitivity increases as the number increases.
---------------------------	--	--

- 4 Press the **Menu** button to confirm the selection, then press the **PTT** switch or the **Side** button to exit the Function Setting mode.

MICROPHONE TYPE

Optional external microphones connected to the transceiver have different audio characteristics. By using this function, you can adjust the audio characteristics and set them for optimum conditions.

1 Enter the Function Setting mode {p.20}.

2 Press the ▲ or ▼ button to select “m TYPE”.



3 Press the **Menu** button then press the ▲ or ▼ button to select your desired value.

<i>off</i>	OFF	It does not correct audio characteristics.
<i>1</i>	1	Set for EMC-13 connection.
<i>2</i>	2	Set for EMC-14 connection.
<i>3</i>	3	Reserve
<i>4</i>	4	Set for KMC-55 connection.
<i>5</i>	5	Set for KHS-37 connection.
<i>6</i>	6	Reserve

4 Press the **Menu** button to confirm the selection, then press the **PTT** switch or the **Side** button to exit the Function Setting mode

EARPHONE MODE

Normally, when the monaural earphone is connected, the **PTT** switch of the transceiver can not be used, If you set the earphone mode to ON, you can transmit using the **PTT** switch of the transceiver.

Note:

- ◆ Please use KENWOOD recommended product for monaural earphones.

- 1 Enter the Function Setting mode {p.20}.
- 2 Press the ▲ or ▼ button to select “*EARPH_o*”.



- 3 Press the **Menu** button then press the ▲ or ▼ button to select your desired value.

<i>off</i>	OFF	When using a dedicated optional earphone microphone, headset, speaker microphone.
<i>on</i>	ON	When using the recommended monaural earphone.

- The  icon appears on the display when “ON” is selected.

- 4 Press the **Menu** button to confirm the selection, then press the **PTT** switch or the **Side** button to exit the Function Setting mode.

Operation of each part by Earphone mode

	Connection with SP/MIC jack	YES		NO	
		Earphone mode	OFF	ON	OFF
Internal	Microphone	disable	enable	enable	enable
	Speaker	disable	disable	enable	enable
	PTT	enable	enable	enable	enable
External	Microphone	enable	disable		
	Speaker	enable	enable		
	PTT	enable	disable		

VOX SETUP

Note:

- ◆ To use the VOX function, you need to set the VOX function to "ON" in Channel Menu mode {p.17}.
-

VOX TYPE

Normal: When the voice level to the microphone is higher than the reference level (VOX Gain Level), the transceiver automatically starts transmission.

Semi-VOX: Transmission is started by pressing **PTT** switch and transmission continues even after **PTT** switch is released.

- 1 Enter the Function Setting mode {p.20}.
- 2 Press the ▲ or ▼ button to select "VOX".



- 3 Press the **Menu** button then press the ▲ or ▼ button to select your desired value.

<i>normal</i>	NORMAL	The VOX type is normal VOX operation.
<i>SEMI</i>	SEMI	The VOX type is semi VOX operation.

- 4 Press the **Menu** button to confirm the selection, then press the **PTT** switch or the **Side** button to exit the Function Setting mode.

VOX GAIN LEVEL

With VOX activated, your voice level will determine when you transmit. Due to the automatic switching between transmission and reception, we recommend you set the VOX gain level such that it will not activate when in an area with excessive ambient noise.

1 Enter the Function Setting mode {p.20}.

2 Press the ▲ or ▼ button to select “*u GRIn*”.



3 Press the **Menu** button then press the ▲ or ▼ button to select your desired value.

<i>1 ~ 10</i>	1 ~ 10	Adjust so that the VOX function works reliably when talking into the microphone. If it does not work even when you speak, gradually increase the level.
---------------	--------	--

- While adjusting the VOX Gain level, speak into the microphone. When an appropriate level is reached, the LED lights yellow, but no signal is transmitted at this time.

4 Press the **Menu** button to confirm the selection, then press the **PTT** switch or the **Side** button to exit the Function Setting mode.

VOX DELAY TIME

If the transceiver returns to receive mode too quickly after you stop speaking, the end of your message may not be transmitted. To avoid this, select an appropriate delay time that allows your entire message to be transmitted.

1 Enter the Function Setting mode {p.20}.

2 Press the ▲ or ▼ button to select “W DELAY”.



3 Press the **Menu** button then press the ▲ or ▼ button to select your desired value.

01/03/05 /10/15/30	0.1/ 0.3/ 0.5/ 1.0/ 1.5/ 3.0	Delay time can be selected from 0.1 second to 3 seconds.
-----------------------	------------------------------------	--

4 Press the **Menu** button to confirm the selection, then press the **PTT** switch or the **Side** button to exit the Function Setting mode.

BUTTON ASSIGNMENT MODE

The **Side** and **Menu** buttons can be programmed with the functions listed below.

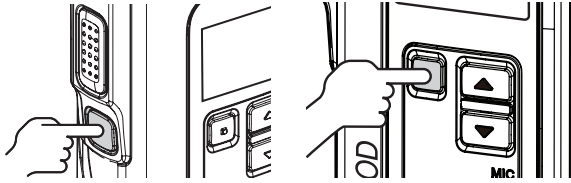

Functions LIST

Function name	Display	Press	Press and hold	Ref. Page
None	<i>none</i>	None	None	–
Button Lock	<i>LOCK</i>	None	Lock/unlock the transceiver buttons.	35
Calling Alert	<i>CALL</i>	Calling Alert	None	35
Channel Down	<i>CH dn</i>	Decreases the Channel number in steps of 1.	Continuously decrease the Channel number.	8
Channel Menu	<i>MENU</i>	Enter the Channel Menu mode.	Lock/unlock the transceiver buttons.	10 35
Channel Up	<i>CH UP</i>	Increases the Channel number in steps of 1.	Continuously increase the Channel number.	8
Fixed Volume	<i>F Vol</i>	Switches various Tone levels of the transceiver among the settings for High, Low or Off.	None	–
Home Channel	<i>HOME</i>	Immediately select your Home Channel.	To set the current channel as the Home Channel.	35
Maintenance	<i>mtc</i>	Enter Maintenance Display Mode.	None	36
Monitor	<i>MON</i>	Turns the transceiver signaling off, to listen to all calls that are received on the channel. Press this button again to turn the transceiver signaling back on.	None	37
Monitor Momentary	<i>MON M</i>	Turns the transceiver signaling off while holding down this button. Release this button to turn the transceiver signaling back on. While signaling is off, you can listen to all calls that are received on the channel.	None	37

Function name	Display	Press	Press and hold	Ref. Page
Scan	<i>SCAN</i>	Starts scanning the transceiver channels.	Adds or removes the selected Channel to or from the scan sequence.	38
Scan Delete/Add	<i>SCAN dA</i>	Adds or removes the selected Channel to or from the scan sequence.	None	38
Second PTT	<i>2nd</i>	Apart from the channel you normally select, you can configure another channel as the main channel with a dedicated PTT switch.	None	40
Volume Attenuation	<i>Att</i>	Volume Attenuation	None	42
Squelch Off	<i>SQ</i>	Press to hear background noise. Press this button again to return to normal operation.	None	37
Squelch Off Momentary	<i>SQ m</i>	Press to hear background noise. Release this button to return to normal operation.	None	37
Zone	<i>Zone</i>	None	Changes the Zone 1, 2, and 3.	42

Note:

- ◆ The “Press and hold” function is assigned automatically.
-

BUTTON LOCK

You can lock the **Menu**, ▲, and ▼ buttons to prevent accidentally changing the operating mode and channel settings. The **Power switch/ Volume control** knob and **PTT** switch still function normally.

Press and hold the button programmed as **[Button Lock]** for 1 second to lock or unlock the transceiver buttons.

- The  icon appears on the display when the transceiver buttons are locked. No icon appears when they are unlocked.



CALLING ALERT (ANALOGUE)

Calling Alert tones help identify yourself to party members and inform them that you are calling. Your dealer can set up your transceiver with 1 of 16 calling alert tones. If each party member uses a different tone, it is easy to know who is calling. To make a call, press and hold the **PTT** switch, then press the key programmed as Calling Alert.

HOME CHANNEL

Press this button to jump to your Home Channel in the current zone. If activated you can set your own Home Channel by selecting your desired channel using Home Channel Select.

- 1 Press the button programmed as **[Home channel]**.

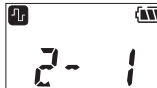

- 2 A beep sounds and "HOME" appears on the display for 1 second.



- 3 Pressing the button programmed as **[Home channel]** again returns to the original channel.

HOME CHANNEL SELECT

Press and hold the button programmed as **[Home channel]** for 1 second to set the current channel as the Home Channel.

MAINTENANCE DISPLAY

Displays the currently received signal strength numerically.

Display example:

- When the signal strength is -80 dBm or more



- When the signal strength is -96 dBm



- When the signal strength is less than -120 dBm





MONITOR

Press to deactivate signaling (QT/DQT or Common ID). Press this button again to return to normal operation.

Monitor: Press this button to allow you to turn the transceiver signaling off, to listen to all calls that are received on the channel.

Monitor Momentary: Press and hold this button to momentarily turn the transceiver signaling off. Releasing this key turns the transceiver signaling back on. While signaling is off, you can listen to all calls that are received on the channel.

	MON	Monitor operation type is Monitor.
	MON M	Monitor operation type is Monitor Momentary.



SQUELCH OFF (ANALOGUE)

When no signals are present, the squelch on the transceiver automatically mutes the speaker so you will not hear background noise. Using the **SQUELCH OFF** button, you can open the squelch to unmute the speaker. This allows you to:

- Confirm the channel activity so you don't make a call while another party is using the same channel

Squelch OFF: Press to hear background noise. Press this key again to return to normal operation.

Squelch OFF Momentary: Continuously hold down this key to hear background noise. Release this key to return to normal operation.

	SQL	Squelch operation type is Squelch OFF.
	SQL M	Squelch operation type is Squelch OFF Momentary.

SCAN

Scan is useful for monitoring signals on the transceiver channels. When scanning, the transceiver checks signals on each channel in the current zone and only stops if a signal is present.

If the QT/ DQT/ Common ID matches, the transceiver stops at the channel and opens the squelch so you can listen to the call. If the QT/ DQT/ Common ID does not match, the call is ignored and scanning continues.

Before using the scan function, ensure that it is activated. You can turn the scan function (the ability to perform scan) ON or OFF in Setting mode.

Scan: Press this button to start scanning the transceiver channels.

Scan Delete/ Add: Press this button to add or remove each channel in the scan sequence.

SCAN OPERATION

To begin scanning:

- 1 To begin scanning, press the button programmed as **[Scan]**.
 - The indicator appears on the display.
 - The channels are scanned.



- 2 When the signal is detected and the QT/ DQT/ Common ID matches, the channel number is displayed on the display and the SCAN icon blinks.



- 3 When the signal is no longer present, the transceiver waits for 3 seconds before scanning continues.
 - If a new signal is received before the 3 seconds elapse, the transceiver will remain on the channel until the new signal is no longer present, at which time it will again wait for 3 seconds before continuing.
- 4 To end the scan at any time, press the button programmed as **[Scan]**.
 - The transceiver returns to the channel you were using before you started scanning.

REVERT CHANNEL

The revert channel is the channel from which you start scanning. For example, if you are on channel 1 when you begin to scan, your revert channel is channel 1.

During scan, pressing the **PTT** switch will automatically select the transceiver's revert channel (in the above example, channel 1) and you will begin transmitting. However, if you are currently paused on another channel after having received a signal (for example, channel 2), pressing the **PTT** switch will allow you to transmit on that channel, rather than returning to the revert channel. Scanning will resume after 3 seconds, unless a signal is present on the channel.

SECOND CHANNEL

Apart from the channel you normally select, you can configure another channel as the main channel with a dedicated **[Second PTT]**. The PTT for the second channel is set with the key that registered the "Second PTT" function using button assignment function in the setting mode.

With the second channel set, it alternately scans the second channel with the channel you normally select.

If there is a received signal, you can stay on that channel and hear the sound.

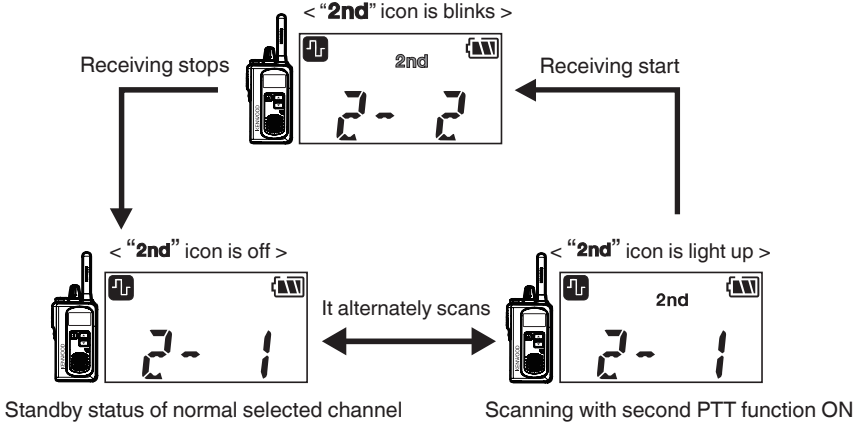

PTT SETUP:

You can set up the transceiver Side button or Menu button to perform Second PTT functions.

- 1 Enter the Function Setting mode {p.20}.
- 2 Press the ▲ or ▼ button to select "SIDE" (Side) or "mEnU" (Menu).



- 3 Press the **Menu** button then press ▲ or ▼ button to select "2nd".



SECOND CHANNEL OPERATION:

- 1 Enter the Function Setting mode {p.20}.
- 2 Press the **Menu** button then press the ▲ or ▼ button to select "2nd 1", "2nd 2", or "2nd 3" for the current zone.



- 3 Press the **Menu** button then press the ▲ or ▼ button to select your desired second channel.

off	OFF	The Second PTT function is deactivated.
1~16	1~16	Select a Second channel.

- 4 When the Second PTT function is activated, "2nd" icon is displayed and scanning starts.
 - When receiving the Second channel, the "2nd" icon blinks and a beep sounds.
- 5 Press the button programmed as [**Second PTT**] moves to the second channel and transmits in that channel.
- 6 When the normal selected channel is in the reception state, the "2nd" icon disappears.
 - To transmit on a normal selected channel, press **PTT** switch.

Note:

- ◆ It is recommended to set different QT/DQT (Analogue) or COMMON ID (Digital) for the normal selected channel and the second PTT channel respectively.
-

VOLUME ATTENUATION

Press this button to attenuate received voice signals.

Speaker Attenuation is a function to temporary lower down the volume level on transceiver itself and external speaker. Use this feature in the quiet environment. As an applied operation, it is usual to leave Attenuation in active, and to cancel Attenuation at important communication, such as emergency.

ZONE

Press and hold this button for 1 second to change the Zone 1, Zone 2 or Zone 3.

BACKGROUND OPERATIONS

BATTERY LEVEL INDICATOR

When turned ON, the battery level indicator on the display lets you know approximately how much battery life is remaining. When turned OFF, the battery level indicator will not be displayed.

When the battery voltage becomes too low while transmitting, the transceiver stops transmitting, a tone sounds, and the LED blinks red until you release the **PTT** switch. Recharge or replace the battery pack.



High battery power



Medium battery power



Low battery power



Recharge the battery pack

RESETTING THE TRANSCEIVER

At some point in time, you may desire to reset the transceiver settings to their default values. (The default values are listed in the "Channel Menu Mode", "Front Panel Programming Mode", and "Function Setting mode" tables.)

To reset the transceiver:

- 1 With the transceiver power OFF, press and hold the ▲ and ▼ buttons while turning the transceiver power ON.
 - "RESET" (reset) will appear on the display.



RESET

- 2 Release the ▲, or ▼ buttons.
 - The confirmation message "SURE" (sure) will appear on the display.



SURE

- 3 Press the PTT switch to reset the transceiver.
 - Press any other button to cancel the reset.

Note:

- ◆ Reset will function even if Super Lock has been activated.
-

OPTIONS

The following options are available for use with this transceiver.

Model Name	Name
KSC-50CR	Charger Pocket
KNB-81L	Li-ion Battery Pack
KBH-22	Belt Clip Holster
KSC-44SL	AC Adapter (Single)
KSC-44ML	AC Adapter (Multiple)
KBH-14	Belt Clip
KBH-20	Belt Clip
KBH-21	Belt Clip
KMC-55	Speaker Microphone
EMC-13	Clip Microphone with Earphone
EMC-14	Clip Microphone with Earphone
KHS-37	Headset
KHS-10-OH-SD	Headset
KHS-22-OH-SD	Headset
KHS-7A-SD	Headset
KPG-197D	Programming Software
KPG-186U	Programming Cable

Note:

- ◆ Optional accessories for use with this transceiver may change, post-production. (New options may become available and/or current options may be discontinued.) Please refer to the options catalog(s) for applicable transceivers.

INSTALLING / REMOVING THE KBH-22

- 1 Install the transceiver on the belt clip holster.
 - Insert the transceiver until "click" sound is heard.
- 2 Push the upper part of the holster to the rear side, remove the lock and pull out the transceiver.

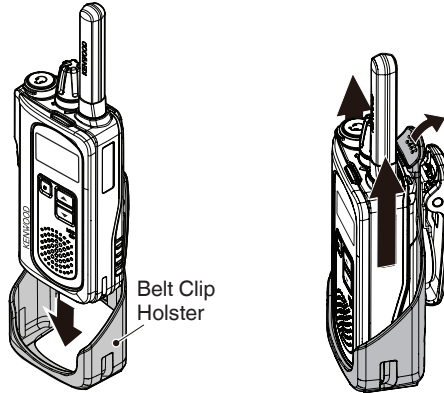

Note:

- ◆ When pulling the transceiver out of the holster, do not hold the antenna, Pull holding the transceiver on both sides.
-

TROUBLESHOOTING GUIDE

Problem	Solution
Cannot turn the transceiver power ON.	<ul style="list-style-type: none"> • The battery pack may be dead. Recharge or replace the battery pack. • The battery pack may not be installed correctly. Remove the battery pack and install it again.
Battery power dies shortly after charging.	<ul style="list-style-type: none"> • The battery pack life is finished. The battery pack may need replacing.
Cannot talk to or hear other members in your group.	<ul style="list-style-type: none"> • Make sure you are using the same frequency and QT/DQT or Common ID setting as the other group members. • Other group members may be using Privacy Talk. Turn on your transceiver's Privacy Talk. • Other group members may be too far away. Make sure you are within range of the other transceivers.
Other voices (besides group members) are present on the channel.	<ul style="list-style-type: none"> • Change the QT/DQT or Common ID settings. Make sure all group members change the settings on their transceivers to match the new QT/DQT or Common ID setting.
The transceiver is malfunctioning for no apparent reason.	<ul style="list-style-type: none"> • Reset the transceiver as described on {p.44}.

SPECIFICATIONS

RF output power	0.5 W e.r.p.
Audio output power	Approx. 750 mW
Frequency stability	Within ± 1.0 ppm
Operating voltage	DC 3.8 ± 0.4 V
Dimensions (W x H x D) (projections not included)	50 x 94 x 27 mm
Weight (with KNB-81L)	160 g

KENWOOD

© 2018 JVC KENWOOD Corporation