

# KENWOOD

## KDC-X7100DAB

CD-RECEIVER

### INSTRUCTION MANUAL

JVCKENWOOD Corporation



PANDORA®



# CONTENTS

BEFORE USE	2
BASICS	3
GETTING STARTED	4
1 Select the display language and cancel the demonstration	
2 Set the clock and date	
3 Set the initial settings	
DIGITAL RADIO	6
ANALOG RADIO	8
CD/USB/iPod/ANDROID	10
AUX	12
Pandora®	13
BLUETOOTH®	14
AUDIO SETTINGS	22
DISPLAY SETTINGS	25
REFERENCES	26
Maintenance	
More information	
TROUBLESHOOTING	29
SPECIFICATIONS	31
INSTALLATION/ CONNECTION	33

# BEFORE USE

## IMPORTANT

- To ensure proper use, please read through this manual before using this product. It is especially important that you read and observe Warning and Caution in this manual.
- Please keep the manual in a safe and accessible place for future reference.

## ▲ WARNING

- **Do not operate any function that takes your attention away from safe driving.**
- **Do not ingest the battery, Chemical Burn Hazard**

The remote control supplied with this product contains a coin/button cell battery.

If the coin/button cell battery is swallowed, it can cause severe internal burns in just 2 hours and can lead to death.

Keep new and used batteries away from children.

If the battery compartment does not close securely, stop using the product and keep it away from children.

If you think batteries might have been swallowed or placed inside any part of the body, seek immediate medical attention.

## ▲ Caution

### Volume setting:

- Adjust the volume so that you can hear sounds outside the car to prevent accidents.
- Lower the volume before playing digital sources to avoid damaging the speakers by the sudden increase of the output level.

### General:

- Avoid using the external device if it might hinder safe driving.
- Make sure all important data has been backed up. We shall bear no responsibility for any loss of recorded data.
- Never put or leave any metallic objects (such as coins or metal tools) inside the unit to prevent a short circuit.
- If a disc error occurs due to condensation on the laser lens, eject the disc and wait for the moisture to evaporate.
- USB rating for the USB cable from the rear of the unit is indicated on a label. (→ 35)
- Depending on the types of cars, the antenna will automatically extend when you turn on the unit with the antenna control wire connected (→ 35). Turn off the unit or change the source to STANDBY when parking at a low ceiling area.

### Remote control (RC-406):

- Do not leave the remote control in hot places such as on the dashboard.
- The Lithium battery is in danger of explosion if replaced incorrectly. Replace it only with the same or equivalent type.
- The battery pack or batteries shall not be exposed to excessive heat such as sunshine, fire or the like.

## How to read this manual

- Operations are explained mainly using buttons on the faceplate.
- English indications are used for the purpose of explanation. You can select the display language from the [FUNCTION] menu. (→ 5)
- [XX] indicates the selected items.
- (→ XX) indicates references are available on the stated page.

# BASICS

## Faceplate

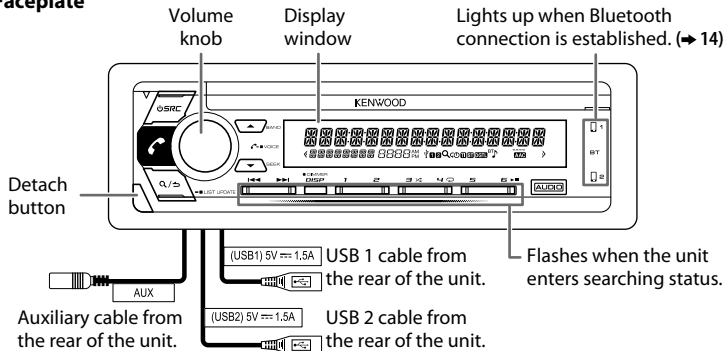

### Attach



### Detach

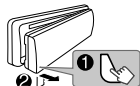

### How to reset

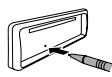

## Remote control (RC-406)

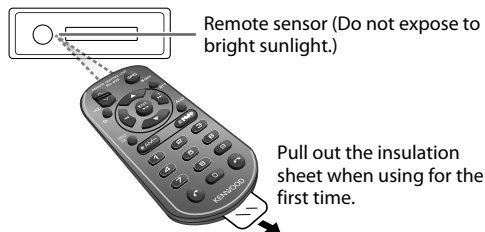

### How to replace the battery

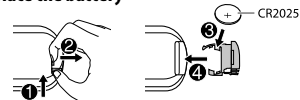

### To

### On the faceplate

#### Turn on the power

Press **SRC**.  
 • Press and hold to turn off the power.

#### Adjust the volume

Turn the volume knob.

#### Select a source

Press **SRC** repeatedly.

#### Change the display information

Press **DISP** repeatedly. (→ 28)

### On the remote control

Press and hold **SRC** to turn off the power.  
 ( Pressing **SRC** does not turn on the power. )

Press **VOL**  $\wedge$  or **VOL**  $\vee$ .  
 • Press and hold **VOL**  $\wedge$  to continuously increase the volume to 15.

Press **ATT** during playback to attenuate the sound.  
 • Press again to cancel.

Press **SRC** repeatedly.

( Not available )

# GETTING STARTED

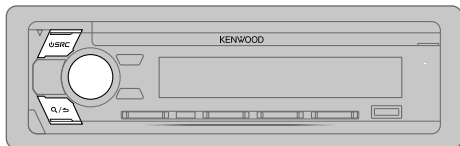

## 1 Select the display language and cancel the demonstration

When you turn on the power for the first time (or [FACTORY RESET] is set to [YES], → 5), the display shows: "SEL LANGUAGE" → "PRESS" → "VOLUME KNOB"

- 1 Turn the volume knob to select [ENG] (English) or [SPA] (Spanish), then press the knob.

[ENG] is selected for the initial setup.

Then, the display shows: "CANCEL DEMO" → "PRESS" → "VOLUME KNOB".

- 2 Press the volume knob.  
[YES] is selected for the initial setup.
- 3 Press the volume knob again.  
"DEMO OFF" appears.

Then, the display shows the selected crossover type: "2-WAY X'OVER" or "3-WAY X'OVER"

- To change the crossover type, see "Change the crossover type". (→ 5)

## 2 Set the clock and date

- 1 Press the volume knob to enter [FUNCTION].
- 2 Turn the volume knob to select [CLOCK], then press the knob.

### To adjust the clock

- 3 Turn the volume knob to select [CLOCK ADJUST], then press the knob.
- 4 Turn the volume knob to make the settings, then press the knob.  
Hour → Minute
- 5 Turn the volume knob to select [CLOCK FORMAT], then press the knob.
- 6 Turn the volume knob to select [12H] or [24H], then press the knob.

### To set the date

- 7 Turn the volume knob to select [DATE FORMAT], then press the knob.
- 8 Turn the volume knob to select [DD/MM/YY] or [MM/DD/YY], then press the knob.
- 9 Turn the volume knob to select [DATE SET], then press the knob.
- 10 Turn the volume knob to make the settings, then press the knob.  
Day → Month → Year or Month → Day → Year
- 11 Press and hold Q/⏪ to exit.

To return to the previous setting item, press Q/⏪.

## 3 Set the initial settings

- 1 Press ⏻ SRC repeatedly to enter STANDBY.
- 2 Press the volume knob to enter [FUNCTION].
- 3 Turn the volume knob to select an item (→ 5), then press the knob.
- 4 Repeat step 3 until the desired item is selected or activated.
- 5 Press and hold Q/⏪ to exit.

To return to the previous setting item, press Q/⏪.

## GETTING STARTED

Default: **XX**

DISPLAY	
<b>EASY MENU</b>	When entering [FUNCTION]... <b>ON:</b> ZONE 1 illumination changes to white color. ; <b>OFF:</b> ZONE 1 illumination remains as [COLOR SELECT] color. (→ 26) • ZONE 2 illumination changes to white color when you enter [FUNCTION], irrespective of the [EASY MENU] setting. • Refer to the illustration on page 25 for ZONE identification.
TUNER SETTING	
<b>DAB L-BAND</b> *1	<b>ON:</b> Receives L-BAND ensemble during digital audio reception. ; <b>OFF:</b> Cancels.
<b>DAB ANT POWER</b>	<b>ON:</b> Supplies power to the DAB antenna. Selects when using the supplied antenna. ; <b>OFF:</b> Does not supply power. Selects when using passive antenna without booster. (→ 36)
<b>PRESET TYPE</b>	<b>NORMAL:</b> Memorizes one station for each preset button in each band (FM1/FM2/FM3/AM/SW1/SW2/DB1/DB2/DB3). ; <b>MIX:</b> Memorizes one station (digital radio or analog radio) for each preset button, regardless of the selected band.
SYSTEM	
<b>KEY BEEP</b> *2	<b>ON:</b> Activates the keypress tone. ; <b>OFF:</b> Deactivates.
<b>TDF ALARM</b> *2	<b>ON:</b> Activates the alarm if you forget to detach the faceplate when ACC is set to OFF. ; <b>OFF:</b> Deactivates.
SOURCE SELECT	
<b>PANDORA SRC</b>	<b>ON:</b> Enables PANDORA in source selection. ; <b>OFF:</b> Disables. (→ 13)
<b>BUILT-IN AUX</b>	<b>ON:</b> Enables AUX in source selection. ; <b>OFF:</b> Disables. (→ 12)
<b>CD READ</b>	1: Automatically distinguishes between audio file disc and music CD. ; 2: Forces to play as a music CD. No sound can be heard if an audio file disc is played.

\*1 This feature is not supported when using the supplied DAB antenna (without L-band support). To use this feature, separately purchase a DAB antenna (with L-band support).

\*2 Not applicable if 3-way crossover is selected.

### F/W UPDATE

#### UPDATE SYSTEM/UPDATE DAB1/UPDATE DAB2

**F/W UPDATE xxxx/** **YES:** Starts upgrading the firmware. ; **NO:** Cancels (upgrading is not activated). For details on how to update the firmware, visit <[www.kenwood.com/cs/ce/](http://www.kenwood.com/cs/ce/)>.  
**F/W UPDATE xxxxx/**  
**F/W UPDATE Vxxx**

**FACTORY RESET** **YES:** Resets the settings to default (except the stored station). ; **NO:** Cancels.

### CLOCK

**CLOCK DISPLAY** **ON:** The clock time is shown on the display even when the unit is turned off. ; **OFF:** Cancels.

**ENGLISH** Select the display language for [FUNCTION] menu and music information if applicable.

**ESPANOL** By default, [ENGLISH] is selected.

### Change the crossover type

- 1 Press **⏻ SRC** repeatedly to enter **STANDBY**.
  - 2 Press and hold number buttons **4** and **5** to enter **crossover select**.  
The current crossover type appears.
  - 3 Turn the volume knob to select **"2WAY"** or **"3WAY"**, then press the knob.
  - 4 Turn the volume knob to select **"YES"** or **"NO"**, then press the knob.  
The selected crossover type appears.
- To cancel, press and hold **⏻ / ⏪**.
  - To adjust the selected crossover settings, (→ 23, 24).

### ⚠ Caution

Select a crossover type according to how the speakers are connected (→ 35). If you select a wrong type:

- The speakers may damage.
- The output sound level may be extremely high or low.

# DIGITAL RADIO

## About DAB (Digital Audio Broadcasting)

DAB is one of the digital radio broadcasting systems available today. It can deliver digital quality sound without any annoying interference or signal distortion. Furthermore, it can carry text, pictures and data.

In contrast to FM broadcast, where each program is transmitted on its own frequency, DAB combines several programs (called "services") to form one "ensemble."

The "primary component" (main radio station) is sometimes accompanied by a "secondary component" which can contain extra programs or other information.

### Preparation:

- 1 Connect the supplied DAB antenna to the DAB antenna jack. (→ 35)
- 2 Press **SRC** repeatedly to select DIGITAL AUDIO.
- 3 Press and hold **Q/↵ (LIST UPDATE)** to start the Service List update.  
"LIST UPDATE" appears and update starts.  
"UPDATED" appears when update completes.  
Updates take up to 3 minutes. No interruption (such as traffic information) is possible during updates.

- To cancel the Service List update:  
Press and hold **Q/↵ (LIST UPDATE)** again.

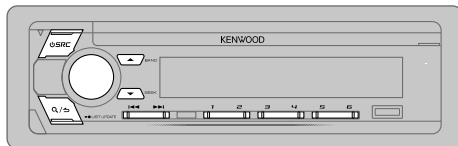

## Search for an ensemble

- 1 Press **SRC** repeatedly to select DIGITAL AUDIO.
  - 2 Press **▲ BAND** repeatedly (or press **#FM+** on the remote control) to select DB1/DB2/DB3.
  - 3 Press and hold **◀◀ / ▶▶** (or press and hold **◀◀ / ▶▶ (+)** on the remote control) to search for an ensemble.
  - 4 Press **◀◀ / ▶▶** (or press **◀◀ / ▶▶ (+)** on the remote control) to select an ensemble, service or component to listen.
- To change the searching method for **◀◀ / ▶▶**: Press **▼ SEEK** repeatedly.  
**AUTO1** : Press **◀◀ / ▶▶**: Select an ensemble, service or component.  
Press and hold **◀◀ / ▶▶**: Automatically search for an ensemble.  
**AUTO2** : Press **◀◀ / ▶▶**: Search for a preset station.  
**MANUAL** : Press **◀◀ / ▶▶**: Select an ensemble, service or component.  
Press and hold **◀◀ / ▶▶**: Manually search for an ensemble.
  - To store a service: Press and hold one of the number buttons (**1** to **6**).
  - To select a stored service: Press one of the number buttons (**1** to **6**) (or press one of the number buttons (**1** to **6**) on the remote control).

## Select a service

- 1 Press **Q/↵** to enter Service Search mode.
- 2 Turn the volume knob or press **▲ / ▼** to select a service, then press the knob.

(or using the remote control)

Press **▲ / ▼** to search for a service, then press **ENT ▶▶**.

To cancel the Service Search mode, press **Q/↵** again.

## DIGITAL RADIO

### Select a service by name

- 1 Press **Q** / **↵** to enter Service Search mode.
- 2 Turn the volume knob quickly to enter Alphabet Search mode.
- 3 Turn the volume knob or press **◀◀** / **▶▶** to select the character to be searched for.  
Press **▲** / **▼** to go to the previous/next page.
- 4 Press the volume knob to start searching.
- 5 Turn the volume knob to select a service, then press the knob.

To cancel the Alphabet Search mode, press **Q** / **↵** again.

### Other settings

- 1 Press the volume knob to enter [FUNCTION].
- 2 Turn the volume knob to select an item (see the following table), then press the knob.
- 3 Repeat step 2 until the desired item is selected/activated or follow the instructions stated on the selected item.
- 4 Press and hold **Q** / **↵** to exit.

To return to the previous setting item, press **Q** / **↵**.

Default: **XX**

### TUNER SETTING

<b>AF SET</b>	<b>ON:</b> While listening to DAB: Automatically switch to FM broadcasting the same program if the DAB signal becomes weak. It will switch back to DAB sound when the signal becomes strong again. While listening to FM: Automatically switch to DIGITAL AUDIO source broadcasting the same program (if available). ; <b>OFF:</b> Cancels.
<b>TI</b>	<b>ON:</b> Allows the unit to temporarily switch to Traffic Information if available ("TI" lights up). ; <b>OFF:</b> Cancels.

<b>PTY SEARCH</b>	<ol style="list-style-type: none"><li>1 Turn the volume knob to select the available Program Type (<b>↔</b> 8), then press the knob.</li><li>2 Turn the volume knob to select the PTY language (<b>ENGLISH/FRENCH/GERMAN</b>), then press the knob.</li><li>3 Press <b>◀◀</b> / <b>▶▶</b> to start searching.</li></ol>
<b>ASW SELECT</b>	<b>TRAVEL, WARNINGS, NEWS, WEATHER, EVENT, SPECIAL, RAD INFO, SPORTS, FINANCE:</b> Turn the volume knob to make a selection, then press the knob. " <b>*</b> " appears in front of the activated announcement type. Automatically switch from any source to Digital radio ensembles broadcasting an activated announcement type. <ul style="list-style-type: none"><li>• Multiple announcement can be activated simultaneously.</li><li>• To deactivate, press the volume knob again ("<b>*</b>" goes off).</li></ul>
<b>LIST UPDATE</b>	<b>AUTO:</b> Automatically update the DAB Service List when the power is turned on. ; <b>MANUAL:</b> Updates the DAB Service List by pressing and holding <b>Q</b> / <b>↵</b> ( <b>LIST UPDATE</b> ).
<b>PTY WATCH</b>	<ol style="list-style-type: none"><li>1 Turn the volume knob to select the available Program Type, then press <b>Q</b> / <b>↵</b>. The unit automatically switch from any source to Digital Radio ensembles broadcasting the selected type of program. Program Type: <b>NEWS, AFFAIRS, INFO, SPORT, EDUCATE, DRAMA, CULTURE, SCIENCE, VARIED, POP M (music), ROCK M (music), EASY M (music), LIGHT M (music), CLASSICS, OTHER M (music), WEATHER, FINANCE, CHILDREN, SOCIAL, RELIGION, PHONE IN, TRAVEL, LEISURE, JAZZ, COUNTRY, NATION M (music), OLDIES, FOLK M (music), DOCUMENT</b> <b>OFF:</b> Cancels.</li><li>2 Press the volume knob to enter PTY language selection.</li><li>3 Turn the volume knob to select the PTY language (<b>ENGLISH/FRENCH/GERMAN</b>), then press the knob.</li></ol>
<b>RELATED SERVICE</b>	<b>ON:</b> Enable Soft-Link function to switch to an alternative service which is different audio program from the current audio program. ; <b>OFF:</b> Disable.

## DIGITAL RADIO

### CLOCK

**TIME SYNC** **ON**: Synchronizes the unit's time to the Digital Radio signal station time.; **OFF**: Cancels.

### Available Program Type for [PTY SEARCH]

**SPEECH**: NEWS, AFFAIRS, INFO (information), SPORT, EDUCATE, DRAMA, CULTURE, SCIENCE, VARIED, WEATHER, FINANCE, CHILDREN, SOCIAL, RELIGION, PHONE IN, TRAVEL, LEISURE, DOCUMENT

**MUSIC**: POP M (music), ROCK M (music), EASY M (music), LIGHT M (music), CLASSICS, OTHER M (music), JAZZ, COUNTRY, NATION M (music), OLDIES, FOLK M (music)

The unit will search for the Program Type categorized under [SPEECH] or [MUSIC] if selected.

- If the volume is adjusted during reception of traffic information, announcement, alarm or news bulletin, the adjusted volume is memorized automatically. It will be applied the next time traffic information, announcement, alarm or news bulletin is turned on.

## ANALOG RADIO

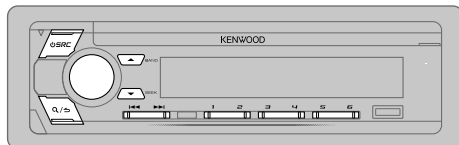

### Search for a station

- 1 Press **⏻ SRC** repeatedly to select TUNER.
  - 2 Press **▲ BAND** repeatedly (or press **#FM+** / **\*AM-** on the remote control) to select FM1/FM2/FM3/AM/SW1/SW2.
  - 3 Press **◀◀ / ▶▶** (or press **◀◀ / ▶▶ (+)** on the remote control) to search for a station.
- To change the searching method for **◀◀ / ▶▶**: Press **▼ SEEK** repeatedly.  
**AUTO1** : Automatically search for a station.  
**AUTO2** : Search for a preset station.  
**MANUAL** : Manually search for a station.
  - To store a station: Press and hold one of the number buttons (**1** to **6**).
  - To select a stored station: Press one of the number buttons (**1** to **6**) (or press one of the number buttons (**1** to **6**) on the remote control).

### Direct Access Tuning (using the remote control)

- 1 Press **DIRECT** to enter Direct Access Tuning.
  - 2 Press the number buttons to enter a frequency.
  - 3 Press **ENT ▶▶** to search for a station.
- To cancel, press **↶** or **DIRECT**.
  - If no operation is done for 10 seconds after step **2**, Direct Access Tuning is automatically canceled.



## ANALOG RADIO

### Other settings

- 1 Press the volume knob to enter [FUNCTION].
- 2 Turn the volume knob to select an item (see the following table), then press the knob.
- 3 Repeat step 2 until the desired item is selected/activated or follow the instructions stated on the selected item.
- 4 Press and hold  $\mathcal{Q}/\mathcal{S}$  to exit.

To return to the previous setting item, press  $\mathcal{Q}/\mathcal{S}$ .

Default: **XX**

TUNER SETTING	
<b>LOCAL SEEK</b>	<b>ON:</b> Searches only AM/SW1/SW2 stations with good reception. ; <b>OFF:</b> Cancels. • Settings made are applicable only to the selected source/station. Once you change the source/station, you need to make the settings again.
<b>AUTO MEMORY</b>	<b>YES:</b> Automatically starts memorizing 6 stations with good reception. ; <b>NO:</b> Cancels. • Selectable only if [NORMAL] is selected for [PRESET TYPE]. (→ 5)
<b>MONO SET</b>	<b>ON:</b> Improves the FM reception, but the stereo effect may be lost. ; <b>OFF:</b> Cancels.
<b>NEWS SET</b>	<b>ON:</b> The unit will temporarily switch to News Programme if available. ; <b>OFF:</b> Cancels.
<b>REGIONAL</b>	<b>ON:</b> Switches to another station only in the specific region using the “AF” control. ; <b>OFF:</b> Cancels.
<b>AF SET</b>	<b>ON:</b> Automatically searches for another station broadcasting the same program in the same Radio Data System network with better reception when the current reception is poor. ; <b>OFF:</b> Cancels.
<b>TI*</b>	<b>ON:</b> Allows the unit to temporarily switch to Traffic Information if available (“TI” lights up). ; <b>OFF:</b> Cancels. * [TI] in AM/SW1/SW2 band is for enabling traffic interruption to DIGITAL AUDIO source only.

- PTY SEARCH**
- 1 Turn the volume knob to select the available Program Type (see the following), then press the knob.
  - 2 Turn the volume knob to select the PTY language (**ENGLISH/FRENCH/GERMAN**), then press the knob.
  - 3 Press  $\mathcal{L}\mathcal{L}/\mathcal{R}\mathcal{R}$  to start searching.

### Available Program Type for [PTY SEARCH]

**SPEECH :** NEWS, AFFAIRS, INFO (information), SPORT, EDUCATE, DRAMA, CULTURE, SCIENCE, VARIED, WEATHER, FINANCE, CHILDREN, SOCIAL, RELIGION, PHONE IN, TRAVEL, LEISURE, DOCUMENT

**MUSIC :** POP M (music), ROCK M (music), EASY M (music), LIGHT M (music), CLASSICS, OTHER M (music), JAZZ, COUNTRY, NATION M (music), OLDIES, FOLK M (music)

The unit will search for the Program Type categorized under [SPEECH] or [MUSIC] if selected.

- [MONO SET]/[NEWS SET]/[REGIONAL]/[AF SET]/[PTY SEARCH] is selectable only when the band is FM1/FM2/FM3.
- If the volume is adjusted during reception of traffic information, alarm or news bulletin, the adjusted volume is memorized automatically. It will be applied the next time traffic information, alarm or news bulletin is turned on.

# CD/USB/iPod/ANDROID

## Start playback

The source changes automatically and playback starts.  
CD

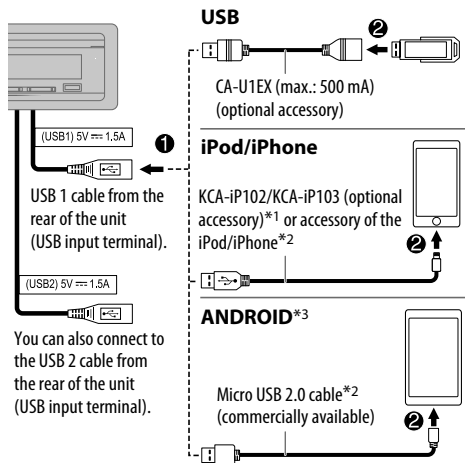
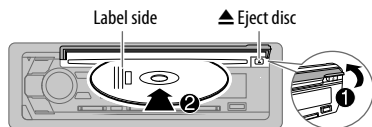

\*1 KCA-iP102 : 30-pin type, KCA-iP103 : Lightning type

\*2 Do not leave the cable inside the car when not using.

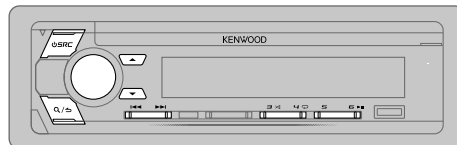

Selectable source: CD/USB 1/USB 2/iPod 1/iPod 2/ANDROID 1/ANDROID 2

To	On the faceplate	On the remote control
Playback/pause	Press <b>6</b> ►  .	Press <b>ENT</b> ►  .
Reverse/ Fast-forward*4	Press and hold ◀◀ / ▶▶.	Press and hold ◀◀ / ▶▶ (+).
Select a track/file	Press ◀◀ / ▶▶.	Press ◀◀ / ▶▶ (+).
Select a folder*5	Press ▲ / ▼.	Press <b>#FM+</b> / <b>*AM-</b> .
Repeat play*6	Press <b>4</b> ↻ repeatedly. <b>TRACK REPEAT/ALL REPEAT</b> : Audio CD <b>FILE REPEAT/FOLDER REPEAT/ALL REPEAT</b> : MP3/WMA/AAC/WAV/ FLAC file <b>FILE REPEAT/FOLDER REPEAT/REPEAT OFF</b> : iPod or ANDROID	
Random play*6	Press <b>3</b> ↻ repeatedly. <b>DISC RANDOM/RANDOM OFF</b> : Audio CD <b>FOLDER RANDOM/RANDOM OFF</b> : MP3/WMA/AAC/WAV/FLAC file, iPod or ANDROID  Press and hold <b>3</b> ↻ to select <b>ALL RANDOM</b> .*7	

\*3 When connecting an Android device, "Press [VIEW] to install KENWOOD MUSIC PLAY APP" is shown. Follow the instructions to install the application. You can also install the latest version of KENWOOD MUSIC PLAY application on your Android device before connecting. For more information, visit <[www.kenwood.com/cs/ce/](http://www.kenwood.com/cs/ce/)>.

\*4 For ANDROID: Applicable only when [BROWSE MODE] is selected. (➡ 11)

\*5 For CD: Only for MP3/WMA/AAC files. This does not work for iPod/ANDROID.

\*6 For iPod/ANDROID: Applicable only when [MODE OFF]/[BROWSE MODE] is selected. (➡ 11)

\*7 For CD: Only for MP3/WMA/AAC files.

## CD/USB/iPod/ANDROID

### Select control mode

While in iPod 1/iPod 2 source, press **5** repeatedly.

**MODE ON** : Control iPod using the iPod itself. However, you can still play/pause, file skip, fast-forward or reverse from this unit.

**MODE OFF** : Control iPod from this unit.

While in ANDROID 1/ANDROID 2 source, press **5** repeatedly.

**BROWSE MODE**: Control Android device from this unit via KENWOOD MUSIC PLAY application installed in the Android device.

**HAND MODE** : Control Android device using the Android device itself via other media player applications installed in the Android device. However, you can still play/pause and file skip from this unit.

### Select music drive

While in USB 1/USB 2 source, press **5** repeatedly.

Stored songs in the following drive will be played back.

- Selected internal or external memory of a smartphone (Mass Storage Class).
- Selected drive of a multiple drives device.

### Listen to TuneIn Radio/TuneIn Radio Pro/Aupeo

While listening to TuneIn Radio, TuneIn Radio Pro or Aupeo, connect the iPod/iPhone to the USB input terminal of the unit.

- The unit will output the sound from these applications.

### Select a file from a folder/list

For iPod/ANDROID, applicable only when [MODE OFF]/[BROWSE MODE] is selected.

**1** Press **Q/↵**.

**2** Turn the volume knob to select a folder/list, then press the knob.

**3** Turn the volume knob to select a file, then press the knob.

**Quick Search** (applicable only for CD, USB 1, USB 2, ANDROID 1 and ANDROID 2 source)

If you have many files, you can search through them quickly.

Turn the volume knob quickly to browse through the list quickly.

**Skip Search** (applicable only for iPod 1, iPod 2, ANDROID 1 and ANDROID 2 source)

Press **◀◀ / ▶▶** to search at a preset skip search ratio. (→ 12, [SKIP SEARCH])

- Pressing and holding **◀◀ / ▶▶** searches at a 10% ratio.

**Alphabet search** (applicable only for iPod 1, iPod 2, ANDROID 1 and ANDROID 2 source)

You can search for a file according to the first character.

**For iPod 1/iPod 2 source**

**1** Turn the volume knob quickly to enter character search.

**2** Turn the volume knob to select the character.

- Select "\*" to search for a character other than A to Z, 0 to 9.

**3** Press **◀◀ / ▶▶** to move to the entry position.

- You can enter up to 3 characters.

**4** Press the volume knob to start searching.

**For ANDROID 1/ANDROID 2 source**

**1** Press **▲ / ▼** to enter character search.

**2** Turn the volume knob to select the character.

^A^: Upper case letters (A to Z)

\_A\_: Lower case letters (a to z)

-0-: Numbers (0 to 9)

\*\*\*: Character other than A to Z, 0 to 9

**3** Press the volume knob to start searching.

- To return to the root folder/first file/top menu, press **5**. (Not applicable for BT AUDIO source.)
- To return to the previous setting item, press **Q/↵**.
- To cancel, press and hold **Q/↵**.

## CD/USB/iPod/ANDROID

### Direct Music Search (using the remote control)

- 1 Press **DIRECT**.
  - 2 Press the number buttons to enter a track/file number.
  - 3 Press **ENT ►||** to search for music.
- To cancel, press **↶** or **DIRECT**.
  - Not available if Random Play is selected.
  - Not applicable for iPod 1, iPod 2, ANDROID 1 and ANDROID 2 source.

### Settings to use KENWOOD Remote application

KENWOOD Remote application is designed to control the KENWOOD car receiver's operations from the iPhone/iPod (via USB input terminal).

#### Preparation:

Install the latest version of KENWOOD Remote application on your device before connecting. For more information, visit <[www.kenwood.com/cs/ce/](http://www.kenwood.com/cs/ce/)>. You can make the settings in the same way as connection via Bluetooth. (→ 20)

### Other settings

- 1 Press the volume knob to enter [FUNCTION].
- 2 Turn the volume knob to select an item (see the following table), then press the knob.
- 3 Repeat step 2 until the desired item is selected or activated.
- 4 Press and hold **Q/↶** to exit.

To return to the previous setting item, press **Q/↶**.

Default: **XX**

USB	
<b>MUSIC DRIVE</b>	<b>DRIVE CHANGE:</b> The next drive ([DRIVE 1] to [DRIVE 4]) is selected automatically and playback starts. Repeat steps <b>1</b> to <b>3</b> to select the following drives.
<b>SKIP SEARCH</b>	<b>0.5%/1%/5%/10%:</b> While listening to iPod 1, iPod 2, ANDROID 1 or ANDROID 2 source, selects the skip search ratio over the total files.

## AUX

#### Preparation:

Select [ON] for [BUILT-IN AUX] for [SOURCE SELECT]. (→ 5)

### Start listening

- 1 Connect a portable audio player (commercially available).

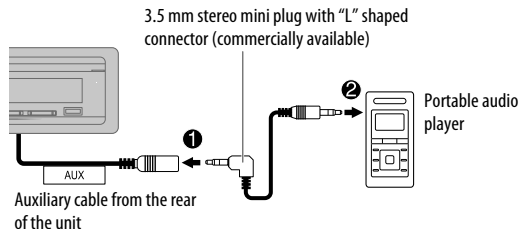

- 2 Press **⏻ SRC** repeatedly to select **AUX**.
- 3 Turn on the portable audio player and start playback.

### Set the AUX name

While listening to a portable audio player connected to the unit...

- 1 Press the volume knob to enter [FUNCTION].
- 2 Turn the volume knob to select [SYSTEM], then press the knob.
- 3 Turn the volume knob to select [AUX NAME SET], then press the knob.
- 4 Turn the volume knob to select an item, then press the knob.  
**AUX (default)/DVD/PORTABLE/GAME/VIDEO/TV**
- 5 Press and hold **Q/↶** to exit.

To return to the previous setting item, press **Q/↶**.

## Preparation:

Install the latest version of the Pandora application on your device (iPhone/iPod touch), then create an account and log in to Pandora.

- Select [ON] for [PANDORA SRC] in [SOURCE SELECT]. (→ 5)

## Start listening

- 1 Open the Pandora application on your device.
- 2 Connect your device to the USB input terminal.

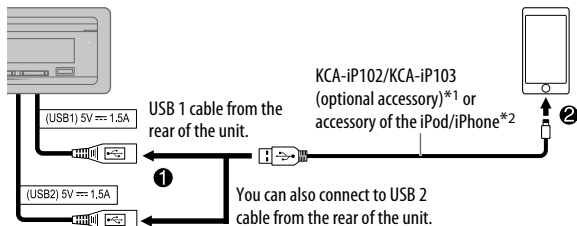

- 3 Press **SRC** repeatedly to select PANDORA 1/PANDORA 2. Broadcast starts automatically.

To	On the faceplate	On the remote control
Playback/pause	Press <b>6 ▶ II.</b>	Press <b>ENT ▶ II.</b>
Skip a track	Press <b>▶▶ I.</b>	Press <b>▶▶ I (+).</b>
Thumbs up or thumbs down*3	Press <b>▲ / ▼.</b>	Press <b>#FM+ / *AM-.</b>

\*1 KCA-iP102 : 30-pin type, KCA-iP103 : Lightning type

\*2 Do not leave the cable inside the car when not using.

\*3 If thumbs down is selected, the current track is skipped.

## Create and save a new station

- 1 Press **Q/↵**.
- 2 Turn the volume knob to select [NEW STATION], then press the knob.
- 3 Turn the volume knob to select [FROM ARTIST] or [FROM TRACK], then press the knob.

A new station is created based on the artist or current song.

- 4 Press and hold one of the number buttons (1 to 5) to store.

To select a stored station: Press one of the number buttons (1 to 5).

## Search for a registered station

- 1 Press **Q/↵**.
- 2 Turn the volume knob to select an item, then press the knob. [SORT BY DATE]: According to the registered date [SORT BY A-Z]: By alphabetical order
- 3 Turn the volume knob (or press **▲ / ▼** on the remote control) to select the desired station.
- 4 Press the volume knob (or press **ENT ▶ II** on the remote control) to confirm.

To cancel, press and hold **Q/↵**.

## Bookmark current song information

Press and hold the volume knob.

"BOOKMARKED" appears and the information is stored to your device.

- The bookmark is available on your Pandora account but not on this unit.

**Delete a station**

While listening to PANDORA 1/PANDORA 2...

- 1 Press **Q/↵**.
- 2 Turn the volume knob to select [STATION DELETE], then press the knob.
- 3 Turn the volume knob to select [SORT BY DATE] or [SORT BY A-Z], then press the knob.
- 4 Turn the volume knob to select the desired station to delete, then press the knob.
- 5 Turn the volume knob to select [YES], then press the knob.
- 6 Press and hold **Q/↵** to exit.

To return to the previous setting item, press **Q/↵**.

**BLUETOOTH®****BLUETOOTH — Connection****Supported Bluetooth profiles**

- Hands-Free Profile (HFP)
- Advanced Audio Distribution Profile (A2DP)
- Audio/Video Remote Control Profile (AVRCP)
- Serial Port Profile (SPP)
- Phonebook Access Profile (PBAP)

**Supported Bluetooth codecs**

- Sub Band Codec (SBC)
- Advanced Audio Coding (AAC)

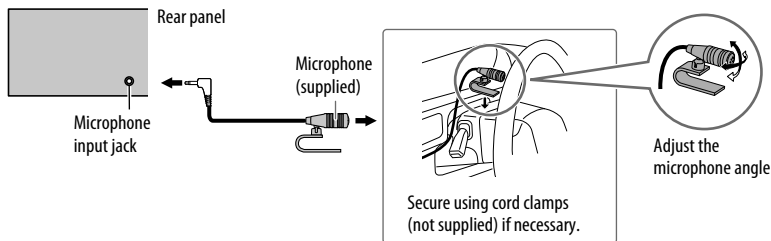
**Connect the microphone****Pair and connect a Bluetooth device for the first time**

- 1 Press **⏻ SRC** to turn on the unit.
- 2 Search and select this unit model name (KDC-X7\*\*\*DAB) on the Bluetooth device.  
 "PAIRING" → "PASS XXXXXX" → Device name → "PRESS" → "VOLUME KNOB" appears on the display.
  - For some Bluetooth devices, you may need to enter the Personal Identification Number (PIN) code immediately after searching.
- 3 Press the volume knob to start pairing.  
 "PAIRING OK" appears when pairing is completed.

Once pairing is completed, Bluetooth connection is established automatically.  
 "BT1" and/or "BT2" indicator on the faceplate lights up.

## BLUETOOTH®

- This unit supports Secure Simple Pairing (SSP).
- Up to five devices can be registered (paired) in total.
- Once the pairing is completed, the Bluetooth device will remain registered in the unit even if you reset the unit. To delete the paired device, ➔ 19, [DEVICE DELETE].
- A maximum of two Bluetooth phones and one Bluetooth audio device can be connected at any time.  
However, while in BT AUDIO source, you can connect to five Bluetooth audio devices and switch between these five devices. (➔ 20)
- Some Bluetooth devices may not automatically connect to the unit after pairing. Connect the device to the unit manually.
- Refer to the instruction manual of the Bluetooth device for more information.

### Auto Pairing

When you connect iPhone/iPod touch/Android device to the USB input terminal, pairing request (via Bluetooth) is automatically activated.

**Press the volume knob to pair once you have confirmed the device name.**

Automatic pairing request is activated only if:

- Bluetooth function of the connected device is turned on.
- [AUTO PAIRING] is set to [ON]. (➔ 19)
- KENWOOD MUSIC PLAY application is installed on the Android device (➔ 10) and [BROWSE MODE] is selected. (➔ 11)

### Connect with a remote device by One-touch (NFC)

Near Field Communication (NFC) enables short-range wireless communication between the unit and remote devices such as smartphones.

By holding an NFC-compatible remote device near to the N-Mark on the unit (right side of the panel), the unit and remote device proceed to complete pairing and established the BLUETOOTH connection automatically.

- 1 Activate the NFC function on the remote device.**  
Refer to the instruction manual of the remote device for more information.
- 2 Hold the remote device near to the N-Mark on the unit (right side of the panel).**  
The device vibrates when pairing is completed.

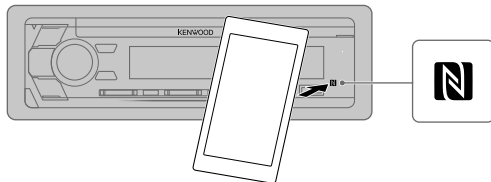

- Depending on the type of remote device used, the strength of the NFC signal may vary. For a stronger NFC signal, user must understand the position of the remote device's NFC antenna and hence tap the NFC antenna with the NFC logo.
- To disconnect, hold the remote device near to the N-Mark on the unit again.
- This unit only can recognize and connect to one NFC-compatible device at a time.

## BLUETOOTH — Mobile phone

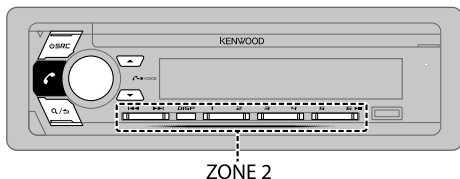

### Receive a call

When there is an incoming call:

- ZONE 2 illuminates in green color and flashes.
- The unit answers the call automatically if [AUTO ANSWER] is set to a selected time. (➔ 17)

During a call:

- ZONE 1 illuminates according to the settings made for [DISPLAY] (➔ 26) and ZONE 2 illuminates in green color.
- If you turn off the unit or detach the faceplate, the Bluetooth connection is disconnected.

The following operations may differ or not available depending on the connected phone.

To	On the faceplate	On the remote control
<b>First incoming call...</b>		
Answer a call	Press  or the volume knob or one of the number buttons (1 to 6).	Press .
Reject a call	Press .	Press .
End a call	Press .	Press .
<b>While talking on the first incoming call...</b>		
Answer another incoming call and hold the current call	Press .	Press .
Reject another incoming call	Press .	Press .
<b>While having two active calls...</b>		
End current call and activate held call	Press .	Press .
Swap between the current call and held call	Press .	Press .
Adjust the phone volume [00] to [35] (Default: [15])	Turn the volume knob during a call. • This adjustment will not affect the volume of the other sources.	( Not available )
Switch between hands-free and private talk modes	Press  during a call. • Operations may vary according to the connected Bluetooth device.	( Not available )



## BLUETOOTH®

### ■ Improve the voice quality

While talking on the phone...

- 1 Press the volume knob to enter [FUNCTION].
- 2 Turn the volume knob to select an item (see the following table), then press the knob.
- 3 Repeat step 2 until the desired item is selected or activated.
- 4 Press and hold  $\mathcal{Q}/\rightarrow$  to exit.

To return to the previous setting item, press  $\mathcal{Q}/\rightarrow$ .

Default: **XX**

MIC GAIN	LEVEL -10 to LEVEL +10 (LEVEL -4): The sensitivity of the microphone increases as the number increased.
NR LEVEL	LEVEL -5 to LEVEL +5 (LEVEL 0): Adjust the noise reduction level until the least noise is being heard during a phone conversation.
ECHO CANCEL	LEVEL -5 to LEVEL +5 (LEVEL 0): Adjust the echo cancellation delay time until the least echo is being heard during a phone conversation.

### ■ Make the settings for receiving a call

- 1 Press  $\mathcal{Q}/\rightarrow$  to enter Bluetooth mode.
- 2 Turn the volume knob to select an item (see the following table), then press the knob.
- 3 Repeat step 2 until the desired item is selected or activated.
- 4 Press and hold  $\mathcal{Q}/\rightarrow$  to exit.

To return to the previous setting item, press  $\mathcal{Q}/\rightarrow$ .

Default: **XX**

SETTINGS	
AUTO ANSWER	1 to 30: The unit answers incoming call automatically in the selected time (in seconds). ; <b>OFF</b> : Cancels.
BATTERY/ SIGNAL*	<b>AUTO</b> : Shows the strength of the battery and signal when the unit detects a Bluetooth device and the Bluetooth device is connected. ; <b>OFF</b> : Cancels. Date is shown.

\* Functionality depends on the type of the phone used.

### Make a call

You can make a call from the call history, phonebook, or dialing the number. Call by voice is also possible if your mobile phone has the feature.

- 1 Press  $\mathcal{Q}/\rightarrow$  to enter Bluetooth mode.  
“(First device name)” appears.
  - If two Bluetooth phones are connected, press  $\mathcal{Q}/\rightarrow$  again to switch to another phone.  
“(Second device name)” appears.
- 2 Turn the volume knob to select an item (see the following table), then press the knob.
- 3 Repeat step 2 until the desired item is selected/activated or follow the instructions stated on the selected item.
- 4 Press and hold  $\mathcal{Q}/\rightarrow$  to exit.

To return to the previous setting item, press  $\mathcal{Q}/\rightarrow$ .

CALL HISTORY	(Applicable only if the phone supports PBAP.) <ol style="list-style-type: none"><li>1 Press the volume knob to select a name or a phone number.<ul style="list-style-type: none"><li>• “INCOMING”, “OUTGOING”, or “MISSED” is shown on the lower part of the display to indicate the previous call status.</li><li>• Press <b>DISP</b> to change the display category (NUMBER or NAME).</li><li>• “NO DATA” appears if there is no recorded call history.</li></ul></li><li>2 Press the volume knob to call.</li></ol>
--------------	--

## PHONE BOOK

(Applicable only if the phone supports PBAP.)

- Turn the volume knob quickly to enter alphabet search mode (if the phonebook contains many contacts).  
The first menu (ABCDEFGHIJKLMN) appears.
  - To go to the other menu (OPQRSTUVWXYZ1\*), press ▲ / ▼.
  - To select the desired first letter, turn the volume knob or press ◀◀ / ▶▶, then press the knob.
 Select "1" to search with numbers and select "\*" to search with symbols.
- Turn the volume knob to select a name, then press the knob.
- Turn the volume knob to select a phone number, then press the knob to call.
  - The phonebook of the connected phone is automatically transferred to the unit when pairing.
  - Contacts are categorized as: HOME, OFFICE, MOBILE, OTHER, GENERAL.
  - This unit can display only non-accent letters. (Accent letters such as "ü" is shown as "U".)

## NUMBER DIAL

- Turn the volume knob to select a number (0 to 9) or character (\*, #, +).
- Press ◀◀ / ▶▶ to move the entry position.  
Repeat steps 1 and 2 until you finish entering the phone number.
- Press the volume knob to call.  
**(or using the remote control)**
  - Press the number buttons (0 to 9) to enter the phone number.
  - Press 📞 to call.

## VOICE

Speak the name of the contact you want to call or the voice command to control the phone functions. (➔ **Make a call using voice recognition**)

**BATTERY LVL LOW/MID/FULL\***: Shows the strength of the battery.

**NO SIGNAL/SIGNAL LVL LOW/MID/MAX\***: Shows the strength of the current received signal.

\* Functionality depends on the type of the phone used.

## Make a call using voice recognition

- Press and hold 📞 to activate the voice recognition of the connected phone.
- Speak the name of the contact you want to call or the voice command to control the phone functions.
  - Supported Voice Recognition features vary for each phone. Refer to the instruction manual of the connected phone for details.
  - This unit also supports the intelligent personal assistant function of iPhone.

## Settings in memory

### Store a contact in memory

You can store up to 6 contacts into the number buttons (1 to 6).

- Press 📞 to enter Bluetooth mode.
- Turn the volume knob to select [CALL HISTORY], [PHONE BOOK], or [NUMBER DIAL], then press the knob.
- Turn the volume knob to select a contact or enter a phone number.  
If a contact is selected, press the volume knob to show the phone number.
- Press and hold one of the number buttons (1 to 6).  
"STORED" appears when the contact is stored.

To erase a contact from the preset memory, select [NUMBER DIAL] in step 2 and store a blank number.

### Make a call from memory

- Press 📞 to enter Bluetooth mode.
- Press one of the number buttons (1 to 6).
- Press the volume knob to call.  
"NO MEMORY" appears if there is no contacts stored.

## BLUETOOTH®

### Other settings

- 1 Press the volume knob to enter [FUNCTION].
- 2 Turn the volume knob to select an item (see the following table), then press the knob.
- 3 Repeat step 2 until the desired item is selected/activated or follow the instructions stated on the selected item.
- 4 Press and hold  $\mathcal{R}/\mathcal{L}$  to exit.

To return to the previous setting item, press  $\mathcal{R}/\mathcal{L}$ .

Default: **XX**

BT MODE	
PHONE SELECT	Selects the phone or audio device to connect or disconnect. “*” appears in front of the device name when connected.
AUDIO SELECT	“▷” appears in front of the current playback audio device. • You can only connect a maximum of two Bluetooth phones and one Bluetooth audio device at any time.
DEVICE DELETE	<ol style="list-style-type: none"><li>1 Turn the volume knob to select a device to delete, then press the knob.</li><li>2 Turn the volume knob to select [YES] or [NO], then press the knob.</li></ol>
PIN CODE EDIT (0000)	Changes the PIN code (up to 6 digits). <ol style="list-style-type: none"><li>1 Turn the volume knob to select a number.</li><li>2 Press <math>\mathcal{L}</math> or <math>\mathcal{R}</math> to move the entry position. Repeat steps 1 and 2 until you finish entering the PIN code.</li><li>3 Press the volume knob to confirm.</li></ol>
RECONNECT	<b>ON:</b> The unit automatically reconnect when the last connected Bluetooth device is within range. ; <b>OFF:</b> Cancels.
AUTO PAIRING	<b>ON:</b> The unit automatically pair supported Bluetooth device (iPhone/iPod touch/Android device) when it is connected through USB input terminal. Depending on the operating system of the connected device, this function may not work. ; <b>OFF:</b> Cancels.
INITIALIZE	<b>YES:</b> Initializes all the Bluetooth settings (including stored pairing, phonebook, and etc.). ; <b>NO:</b> Cancels.

### Bluetooth test mode

You can check the connectivity of the supported profile between the Bluetooth device and the unit.

- Make sure there is no Bluetooth device paired.

- 1 Press and hold  $\mathcal{R}$ .  
“PLEASE PAIR YOUR PHONE PIN 0000” appears.
- 2 Search and select this unit model name (KDC-X7\*\*\*DAB) on the Bluetooth device.
- 3 Operate the Bluetooth device to confirm pairing.  
“TESTING” flashes on the display.

The connectivity result (OK or NG) appears after the test.

PAIRING:	Pairing status
HF CONNECT:	Hands-Free Profile (HFP) compatibility
AUDIO CONNECT:	Advanced Audio Distribution Profile (A2DP) compatibility
PHONEBOOK DL:	Phonebook Access profile (PBAP) compatibility

To cancel test mode, press and hold  $\mathcal{P}$  SRC to turn off the unit.

## BLUETOOTH®

### BLUETOOTH — Audio

While in BT AUDIO source, you can connect to five Bluetooth audio devices and switch between these five devices.

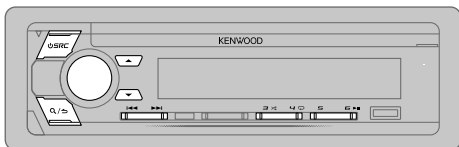

#### Audio player via Bluetooth

- 1 Press **SRC** repeatedly (or press **SRC** on the remote control) to select BT AUDIO.
- 2 Operate the Bluetooth audio player to start playback.

To	On the faceplate	On the remote control
Playback/pause	Press <b>6</b> <b>II</b> .	Press <b>ENT</b> <b>II</b> .
Select group or folder	Press <b>▲</b> / <b>▼</b> .	Press <b>#FM+</b> / <b>*AM-</b> .
Reverse/Forward skip	Press <b>◀◀</b> / <b>▶▶</b> .	Press <b>◀◀</b> / <b>▶▶</b> (+).
Reverse/Fast-forward	Press and hold <b>◀◀</b> / <b>▶▶</b> .	Press and hold <b>◀◀</b> / <b>▶▶</b> (+).
Repeat play	Press <b>4</b> <b>↻</b> repeatedly. ALL REPEAT, FILE REPEAT, REPEAT OFF	( Not available )
Random play	Press and hold <b>3</b> <b>↻</b> to select ALL RANDOM. • Press <b>3</b> <b>↻</b> to select RANDOM OFF.	( Not available )
Select a file from a folder/list	Refer to “Select a file from a folder/list” on page 11.	( Not available )

To	On the faceplate	On the remote control
Switch between connected Bluetooth audio devices	Press <b>5</b> .*	( Not available )

\* Pressing the “Play” key on the connected device itself also causes switching of sound output from the device.

Operations and display indications may differ according to their availability on the connected device.

#### Settings to use KENWOOD Remote application

KENWOOD Remote application is designed to control the KENWOOD car receiver's operations from the iPhone/iPod (via Bluetooth or via USB input terminal) or Android smartphone (via Bluetooth).

##### Preparation:

Install the latest version of KENWOOD Remote application on your device before connecting. For more information, visit [www.kenwood.com/cs/ce/>](http://www.kenwood.com/cs/ce/>).

- 1 Press the volume knob to enter [FUNCTION].
- 2 Turn the volume knob to select an item (➔ 21), then press the knob.
- 3 Repeat step 2 until the desired item is selected or activated.
- 4 Press and hold **Q/↵** to exit.

To return to the previous setting item, press **Q/↵**.

Default: **XX**

REMOTE APP	
<b>SELECT</b>	Select the device (IOS or ANDROID) to use the application.
<b>IOS</b>	<p><b>YES:</b> Selects iPhone/iPod to use the application via Bluetooth or connected via USB input terminal. ; <b>NO:</b> Cancels.</p> <p>If IOS is selected, select iPod BT source (or iPod 1/iPod 2 if your iPhone/iPod is connected via USB input terminal) to activate the application.</p> <ul style="list-style-type: none"> <li>The connectivity of the application will be interrupted or disconnected if:           <ul style="list-style-type: none"> <li>You change from iPod BT source to any playback source connected via the USB input terminal.</li> <li>You change from iPod 1/iPod 2 source to iPod BT source.</li> </ul> </li> </ul>
<b>ANDROID</b>	<b>YES:</b> Selects Android smartphone to use the application via Bluetooth. ; <b>NO:</b> Cancels.
<b>ANDROID LIST*</b>	Selects the Android smartphone to use from the list.
<b>STATUS</b>	<p>Shows the status of the selected device.</p> <p><b>IOS CONNECTED:</b> You are able to use the application using the iPhone/iPod connected via Bluetooth or USB input terminal.</p> <p><b>IOS NOT CONNECTED:</b> No IOS device is connected to use the application.</p> <p><b>ANDROID CONNECTED:</b> You are able to use the application using the Android smartphone connected via Bluetooth.</p> <p><b>ANDROID NOT CONNECTED:</b> No Android device is connected to use the application.</p>

\* Displayed only when [ANDROID] of [SELECT] is set to [YES].

## Listen to iPhone/iPod via Bluetooth

You can listen to the songs on the iPhone/iPod via Bluetooth on this unit.

Press **⏻ SRC repeatedly to select iPod BT.**

- You can operate the iPod/iPhone in the same way as iPod/iPhone via USB input terminal. (➔ 10)
- If you plug in an iPhone/iPod to the USB input terminal while listening to iPod BT source, the source automatically change to iPod 1/iPod 2. Press **⏻ SRC** to select iPod BT if the device is still connected via Bluetooth.

## Internet radio via Bluetooth

### Listen to Pandora

You can listen to Pandora on the iPhone/iPod/Android device via Bluetooth on this unit.

- Make sure the USB input terminal is not connected to any device.

**Preparation:**

Select [ON] for [PANDORA SRC] in [SOURCE SELECT]. (➔ 5)

- Open the Pandora application on your device.
  - Connect your device via Bluetooth connection. (➔ 14)
  - Press **⏻ SRC repeatedly to select PANDORA (for iPhone/iPod) or PANDORA BT (for Android device).**  
The source switches and broadcast starts automatically.
- You can operate Pandora in the same way as Pandora via USB input terminal. (➔ 13)

# AUDIO SETTINGS

While listening to any source...

- 1 Press **AUDIO** to enter [AUDIO CONTROL] directly.
- 2 Turn the volume knob to select an item (see the following table), then press the knob.
- 3 Repeat step 2 until the desired item is selected or activated.
- 4 Press and hold **Q**/**↵** to exit.

(or using the remote control)

- 1 Press **AUD** to enter [AUDIO CONTROL].
- 2 Press **▲**/**▼** to select an item, then press **ENT ▶||**.

To return to the previous setting item, press **Q**/**↵**.

Default: **XX**

AUDIO CONTROL	
<b>SUB-W LEVEL</b>	<b>LEVEL -50 to LEVEL +10 (LEVEL 0):</b> Adjusts the subwoofer output level.
<b>MANUAL EQ</b>	The sound elements (frequency level, tone level, Q factor) are preset into each selection.
<b>62.5HZ LEVEL</b>	<b>LEVEL</b> <b>LEVEL -9 to LEVEL +9 (LEVEL 0):</b> Adjusts the level to memorize for each source. (Before making an adjustment, select the source you want to adjust.)
	<b>BASS EXTEND</b> <b>ON:</b> Turns on the extended bass. ; <b>OFF:</b> Cancels.
<b>100 HZ/160 HZ/250 HZ/400 HZ/630 HZ/1 KHZ/1.6KHZ/2.5KHZ/4 KHZ/6.3KHZ/10 KHZ/16 KHZ LEVEL</b>	<b>LEVEL -9 to LEVEL +9 (LEVEL 0):</b> Adjusts the level to memorize for each source. (Before making an adjustment, select the source you want to adjust.)
<b>Q FACTOR</b>	<b>1.35/1.50/2.00:</b> Adjust the quality factor.

<b>PRESET EQ</b>	<b>NATURAL/ROCK/POPS/EASY/TOP40/JAZZ/POWERFUL/USER:</b> Selects a preset equalizer suitable to the music genre. (Select [USER] to use the settings made in [MANUAL EQ].)
<b>BASS BOOST</b>	<b>LEVEL1/LEVEL2/LEVEL3/LEVEL4/LEVEL5:</b> Selects your preferred bass boost level. ; <b>OFF:</b> Cancels.
<b>LOUDNESS</b>	<b>LEVEL1/LEVEL2:</b> Selects your preferred low and high frequencies boost to produce a well-balanced sound at a low volume level. ; <b>OFF:</b> Cancels.
<b>SUBWOOFER SET</b>	<b>ON:</b> Turns on the subwoofer output. ; <b>OFF:</b> Cancels.
<b>FADER</b>	(Not applicable if 3-way crossover is selected.) <b>REAR 15 to FRONT15 (Q):</b> Adjusts the rear and front speaker output balance.
<b>BALANCE</b>	<b>LEFT 15 to RIGHT15 (Q):</b> Adjusts the left and right speaker output balance.
<b>VOLUME OFFSET</b>	<b>LEVEL -15 to LEVEL +6 (LEVEL 0):</b> Preset the initial volume level of each source. (Before adjustment, select the source you want to adjust.)
<b>SOUND EFFECT</b>	
<b>SOUND RECONSTR</b> (Sound reconstruction)	(Not applicable for TUNER source, DIGITAL AUDIO source and AUX source.) <b>ON:</b> Creates realistic sound by compensating the high-frequency components and restoring the rise-time of the waveform that are lost in audio data compression. ; <b>OFF:</b> Cancels.
<b>SPACE ENHANCER</b>	(Not applicable for TUNER source and DIGITAL AUDIO source.) <b>SMALL/MEDIUM/LARGE:</b> Virtually enhances the sound space. ; <b>OFF:</b> Cancels.
<b>SOUND REALIZER</b>	<b>LEVEL1/LEVEL2/LEVEL3:</b> Virtually makes the sound more realistic. ; <b>OFF:</b> Cancels.
<b>STAGE EQ</b>	<b>LOW/MIDDLE/HIGH:</b> Virtually adjust the sound position heard from the speakers. ; <b>OFF:</b> Cancels.
<b>DRIVE EQ</b>	<b>ON:</b> Boosts the frequency to reduce the noise heard from outside the car or running noise of the tyres. ; <b>OFF:</b> Cancels.
<b>SPEAKER SIZE</b>	Depending on the crossover type you have selected (➡ 5), 2-way crossover or 3-way crossover setting items will be shown (➡ 23, 24).
<b>X'OVER</b>	By default, 2-way crossover type is selected.

- [SUB-W LEVEL] is selectable only if [SUBWOOFER SET] is set to [ON].

## AUDIO SETTINGS

### DTA SETTINGS

For settings, ➔ 24, Digital Time Alignment Settings.

### CAR SETTINGS

### Crossover settings

Below are the available setting items for 2-way crossover and 3-way crossover.

#### SPEAKER SIZE

Selects according to the connected speaker size for optimum performance.

- The frequency and slope settings are automatically set for the crossover of the selected speaker.
- When 2-way crossover is selected, if [NONE] is selected for [TWEETER] of [FRONT], [REAR] and [SUBWOOFER] for [SPEAKER SIZE], the [X'OVER] setting of the speaker is not available.
- When 3-way crossover is selected, if [NONE] is selected for [WOOFER] of [SPEAKER SIZE], the [X'OVER] setting of [WOOFER] is not available.

#### X'OVER

- [FRQ]/[FRONT-HPF FRQ]/[REAR-HPF FRQ]/[SW LPF FRQ]/[HPF FRQ]/[LPF FRQ]: Adjusts the crossover frequency for the selected speakers (high pass filter or low pass filter).  
If [THROUGH] is selected, all signals are sent to the selected speakers.
- [FRONT-HPF SLOPE]/[REAR-HPF SLOPE]/[SW LPF SLOPE]/[HPF SLOPE]/[LPF SLOPE]: Adjusts the crossover slope.  
Selectable only if a setting other than [THROUGH] is selected for the crossover frequency.
- [SW LPF PHASE]/[PHASE]: Selects the phase of the speaker output to be in line with the other speaker output.
- [GAIN LEFT]/[GAIN RIGHT]/[FRONT-HPF GAIN]/[REAR-HPF GAIN]/[SW LPF GAIN]/[GAIN]: Adjusts the output volume of the selected speaker.

## 2-way crossover setting items

### SPEAKER SIZE

FRONT	SIZE	8CM/10CM/12CM/13CM/ <u>16CM</u> /17CM/18CM/4×6/5×7/6×8/6×9/7×10
	TWEETER	SMALL/ <u>MIDDLE</u> /LARGE/NONE (not connected)
REAR		8CM/10CM/12CM/13CM/ <u>16CM</u> /17CM/18CM/4×6/5×7/6×8/6×9/7×10/ NONE (not connected)
SUBWOOFER*		16CM/20CM/ <u>25CM</u> /30CM/38CM OVER/NONE (not connected)

### X'OVER

TWEETER	FRQ	1KHZ/1.6KHZ/2.5KHZ/ <u>4KHZ</u> /5KHZ/6.3KHZ/8KHZ/10KHZ/12.5KHZ
	GAIN LEFT	-8 to <u>0</u>
	GAIN RIGHT	-8 to <u>0</u>
FRONT HPF	FRONT-HPF FRQ	30HZ/40HZ/50HZ/60HZ/70HZ/80HZ/90HZ/100HZ/120HZ/150HZ/180HZ/220HZ/250HZ/ <u>THROUGH</u>
	FRONT-HPF SLOPE	-6DB/ <u>-12DB</u> /-18DB/-24DB
	FRONT-HPF GAIN	-8 to <u>0</u>
REAR HPF	REAR-HPF FRQ	
	REAR-HPF SLOPE	(Refer FRONT HPF settings above.)
	REAR-HPF GAIN	
SUBWOOFER LPF*	SW LPF FRQ	30HZ/40HZ/50HZ/60HZ/70HZ/80HZ/90HZ/100HZ/120HZ/150HZ/180HZ/220HZ/250HZ/ <u>THROUGH</u>
	SW LPF SLOPE	-6DB/ <u>-12DB</u> /-18DB/-24DB
	SW LPF PHASE	REVERSE (180°)/ <u>NORMAL</u> (0°)
	SW LPF GAIN	-8 to <u>0</u>

\* Selectable only when [SUBWOOFER SET] is set to [ON]. (➔ 22)

## AUDIO SETTINGS

### 3-way crossover setting items

SPEAKER SIZE			
TWEETER		SMALL/MIDDLE/LARGE	
MID RANGE		8CM/10CM/12CM/13CM/16CM/17CM/18CM/4×6/5×7/6×8/6×9	
WOOFER*		16CM/20CM/25CM/30CM/38CM OVER/NONE (not connected)	
X' OVER			
TWEETER	HPF FRQ	1KHZ/1.6KHZ/2.5KHZ/4KHZ/5KHZ/6.3KHZ/8KHZ/10KHZ/12.5KHZ	
	SLOPE	-6DB/-12DB	
	PHASE	REVERSE (180°)/NORMAL (0°)	
	GAIN	-8 to 0	
MID RANGE	HPF FRQ	30HZ/40HZ/50HZ/60HZ/70HZ/80HZ/90HZ/100HZ/120HZ/150HZ/180HZ/220HZ/250HZ/THROUGH	
	HPF SLOPE	-6DB/-12DB	
	LPF FRQ	1KHZ/1.6KHZ/2.5KHZ/4KHZ/5KHZ/6.3KHZ/8KHZ/10KHZ/12.5KHZ/THROUGH	
	LPF SLOPE	-6DB/-12DB	
	PHASE	REVERSE (180°)/NORMAL (0°)	
	GAIN	-8 to 0	
WOOFER*	LPF FRQ	30HZ/40HZ/50HZ/60HZ/70HZ/80HZ/90HZ/100HZ/120HZ/150HZ/180HZ/220HZ/250HZ/THROUGH	
	SLOPE	-6DB/-12DB	
	PHASE	REVERSE (180°)/NORMAL (0°)	
	GAIN	-8 to 0	

\* Selectable only when [SUBWOOFER SET] is set to [ON]. (→ 22)

### Digital Time Alignment settings

Digital Time Alignment sets the delay time of the speaker output to create a more suitable environment for your vehicle.

- For more information, → 25, Determining the value for [DISTANCE] and [GAIN] of [DTA SETTINGS].

#### DTA SETTINGS

POSITION	Selects your listening position (reference point). <b>ALL</b> : Not compensating ; <b>FRONT RIGHT</b> : Front right seat ; <b>FRONT LEFT</b> : Front left seat ; <b>FRONT ALL</b> : Front seat • [FRONT ALL] is displayed only when [2-WAY X'OVER] is selected. (→ 5)
DISTANCE	<b>0CM</b> to <b>610CM</b> : Fine adjust the distance to compensate. (Before making an adjustment, select the speaker you want to adjust.)
GAIN	<b>-8DB</b> to <b>0DB</b> : Fine adjust the output volume of the selected speaker. (Before making an adjustment, select the speaker you want to adjust.)
DTA RESET	<b>YES</b> : Resets the settings ([DISTANCE] and [GAIN]) of the selected [POSITION] to default. ; <b>NO</b> : Cancels.

#### CAR SETTINGS

CAR TYPE	Identify your car type and rear speaker location in order to make the adjustment for [DTA SETTINGS].
CAR TYPE	<b>COMPACT/FULL SIZE CAR/WAGON/MINIVAN/SUV/MINIVAN(LONG)</b> : Selects the type of vehicle. ; <b>OFF</b> : Not compensating.
REAR-SP LOCATION	Selects the location of the rear speakers in your vehicle to calculate the furthest distance from the listening position selected (reference point). • <b>DOOR/REAR DECK</b> : Selectable only when [CAR TYPE] is selected as [OFF], [COMPACT], [FULL SIZE CAR], [WAGON] or [SUV]. • <b>2ND ROW/3RD ROW</b> : Selectable only when [CAR TYPE] is selected as [MINIVAN] or [MINIVAN(LONG)].



## AUDIO SETTINGS

- Before making an adjustment for [DISTANCE] and [GAIN] of [DTA SETTINGS], select the speaker you want to adjust:

When 2-way crossover is selected:

### FRONT LEFT/FRONT RIGHT/REAR LEFT/REAR RIGHT/SUBWOOFER

- You can only select [REAR LEFT], [REAR RIGHT] and [SUBWOOFER] if a setting other than [NONE] is selected for [REAR] and [SUBWOOFER] of [SPEAKER SIZE]. (→ 23)

When 3-way crossover is selected:

### TWEETER LEFT/TWEETER RIGHT/MID LEFT/MID RIGHT/WOOFER

- You can only select [WOOFER] if a setting other than [NONE] is selected for [WOOFER] of [SPEAKER SIZE]. (→ 24)
- [REAR-SP LOCATION] of [CAR SETTINGS] is selectable only if:
    - 2-way crossover is selected. (→ 5)
    - A setting other than [NONE] is selected for [REAR] of [SPEAKER SIZE]. (→ 23)

### Determining the value for [DISTANCE] and [GAIN] of [DTA SETTINGS]

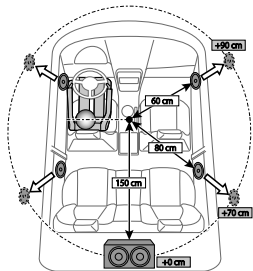

If you specify the distance from the center of the currently set listening position to every speaker, the delay time will be automatically computed and set.

- 1 Determine the center of the currently set listening position as the reference point.
- 2 Measure the distances from the reference point to the speakers.
- 3 Calculate the differences between the distance of the furthest speaker (rear speaker) and other speakers.
- 4 Set the [DISTANCE] calculated in step 3 for individual speakers.
- 5 Adjust [GAIN] for individual speakers.

Example: When [FRONT ALL] is selected as the listening position

## DISPLAY SETTINGS

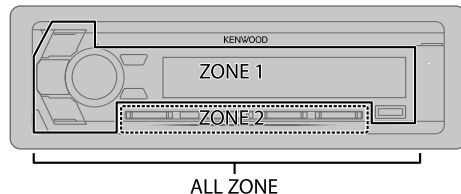

### Set the dimmer

Press and hold **DISP (DIMMER)** to turn on or off the dimmer.

- If you have set [DIMMER TIME], it will be canceled once you press and hold this button.

### Other settings

- 1 Press the volume knob to enter [FUNCTION].
- 2 Turn the volume knob to select an item (→ 26), then press the knob.
- 3 Repeat step 2 until the desired item is selected/activated or follow the instructions stated on the selected item.
- 4 Press and hold **Q/▷** to exit.

To return to the previous setting item, press **Q/▷**.

## DISPLAY SETTINGS

Default: **XX**

DISPLAY	
<b>COLOR SELECT</b>	<p>Select color for <b>ALL ZONE, ZONE 1</b> and <b>ZONE 2</b> separately.</p> <ol style="list-style-type: none"><li>1 Select a zone. (See the illustration on page 25.)</li><li>2 Select a color for the selected zone. <b>VARIABLE SCAN/CUSTOM R/G/B/preset colors*</b></li></ol> <p>To make your own color, select [<b>CUSTOM R/G/B</b>]. The color you have made will be stored in [<b>CUSTOM R/G/B</b>].</p> <ol style="list-style-type: none"><li>1 Press the volume knob to enter the detailed color adjustment.</li><li>2 Press <b>◀◀ / ▶▶</b> to select the color (R/G/B) to adjust.</li><li>3 Turn the volume knob to adjust the level (0 to 9), then press the knob.</li></ol>
<b>DIMMER</b>	<p>Dim the illumination.</p> <p><b>ON:</b> Dimmer is turned on. ; <b>OFF:</b> Cancels.</p> <p><b>DIMMER TIME:</b> Set the dimmer on and off time.</p> <ol style="list-style-type: none"><li>1 Turn the volume knob to adjust the [<b>ON</b>] time, then press the knob.</li><li>2 Turn the volume knob to adjust the [<b>OFF</b>] time, then press the knob. (Default: [<b>ON</b>]: <b>PM6:00</b>; [<b>OFF</b>]: <b>AM6:00</b>)</li></ol>
<b>BRIGHTNESS</b>	<ol style="list-style-type: none"><li>1 Select a zone. (See the illustration on page 25.)</li><li>2 <b>LEVEL 0</b> to <b>LEVEL 31</b>: Select your preferred brightness level for the selected zone.</li></ol>
<b>TEXT SCROLL</b>	<p><b>AUTO/ONCE:</b> Select whether to scroll the display information automatically, or scroll only once. ; <b>OFF:</b> Cancels.</p>

\* Preset colors: **RED1/RED2/RED3/PURPLE1/PURPLE2/PURPLE3/PURPLE4/BLUE1/BLUE2/BLUE3/SKYBLUE1/SKYBLUE2/LIGHTBLUE/AQUA1/AQUA2/GREEN1/GREEN2/GREEN3/YELLOWGREEN1/YELLOWGREEN2/YELLOW/ORANGE1/ORANGE2/ORANGERED**

## REFERENCES

### ■ Maintenance

#### Cleaning the unit

Wipe off dirt on the faceplate with a dry silicone or soft cloth.

#### Cleaning the connector

Detach the faceplate and clean the connector gently with a cotton swab, being careful not to damage the connector.

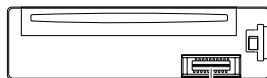

Connector (on the reverse side of the faceplate)

#### Handling discs

- Do not touch the recording surface of the disc.
- Do not stick tape etc. on the disc, or use a disc with tape stuck on it.
- Do not use any accessories for the disc.
- Clean from the center of the disc and move outward.
- Clean the disc with a dry silicone or soft cloth. Do not use any solvents.
- When removing discs from this unit, pull them out horizontally.
- Remove burrs from the center hole and disc edge before inserting a disc.

### ■ More information

For: – Latest firmware updates and latest compatible item list  
– KENWOOD original application  
– Any other latest information  
Visit <[www.kenwood.com/cs/ce/](http://www.kenwood.com/cs/ce/)>.

#### General

- This unit can only play the following CDs:



- For detailed information and notes about the playable audio files, visit <[www.kenwood.com/cs/ce/audiofile/](http://www.kenwood.com/cs/ce/audiofile/)>.

## REFERENCES

---

### Playable files

- Playable audio file:
  - For disc: MP3 (.mp3), WMA (.wma), AAC (.aac)
  - For USB mass storage class device: MP3 (.mp3), WMA (.wma), AAC (.aac), WAV (.wav), FLAC (.flac)
- Playable disc media: CD-R/CD-RW/CD-ROM
- Playable disc file format: ISO 9660 Level 1/2, Joliet, Long file name.
- Playable USB device file system: FAT12, FAT16, FAT32

Even when audio files comply with the standards listed above, playback may be impossible depending on the types or conditions of media or device.

AAC files encoded in (.m4a) format by iTunes cannot be played on this unit.

### Unplayable discs

- Discs that are not round.
- Discs with coloring on the recording surface or discs that are dirty.
- Recordable/ReWritable discs that have not been finalized.
- 8 cm CD. Attempting to insert using an adapter may cause malfunction.

### About USB devices

- You cannot connect a USB device via a USB hub.
- Connecting a cable whose total length is longer than 5 m may result in abnormal playback.
- This unit cannot recognize a USB device whose rating is other than 5 V and exceeds 1.5 A.

### About iPod/iPhone

- Via USB:
  - Made for
    - iPod touch (5th and 6th generation)
    - iPod nano (7th generation)
    - iPhone 4S, 5, 5S, 5C, 6, 6 Plus, 6S, 6S Plus, SE
- Via Bluetooth:
  - Made for
    - iPod touch (5th and 6th generation)
    - iPhone 4S, 5, 5S, 5C, 6, 6 Plus, 6S, 6S Plus, SE
- You cannot operate iPod if “KENWOOD” or “” is displayed on iPod.
- Depending on the version of the operating system of the iPod/iPhone, some functions may not operate on this unit.

### About Android device

- This unit supports Android OS 4.1 and above.
- Some Android devices (with OS 4.1 and above) may not fully support Android Open Accessory (AOA) 2.0.
- If the Android device supports both mass storage class device and AOA 2.0, this unit always playback via AOA 2.0 as priority.

### About Pandora

- Pandora is only available in certain countries. For more information, visit <<http://www.pandora.com/legal>>.
- Because Pandora is a third-party service, the specifications are subject to change without prior notice. Accordingly, compatibility may be impaired, or some or all of the services may become unavailable.
- Some functions of Pandora cannot be operated from this unit.
- For issues using the application, please contact Pandora at [pandora-support@pandora.com](mailto:pandora-support@pandora.com).

### About Bluetooth

- Depending on the Bluetooth version of the device, some Bluetooth devices may not be able to connect to this unit.
- This unit may not work with some Bluetooth devices.
- Signal conditions vary, depending on the surroundings.
- Compatible remote device for NFC function:
  - Remote devices with a NFC function (OS: Android™ 2.3.3 or later, excluding Android 3.x).
  - If the OS version of your remote device is older than Android 4.1.x, download and start the “NFC Easy Connect” application. (“NFC Easy Connect” is a free application available at Google Play.)

## REFERENCES

### Change the display information

Each time you press **DISP**, the display information changes.

- If the information is unavailable or not recorded, "NO TEXT", "NO INFO", or other information (eg. station name, playing time) appears.

Source name	Display information
STANDBY	Source name (Date)*
DIGITAL AUDIO	Service label (Ensemble) → Service label (Date)* → Dynamic label (Date)* → Music title (Artist) → Music title (Date)* → Next program (Date)* → Signal level (Date)* → (back to the beginning)
TUNER	Frequency (Date)* <b>(For FM Radio Data System stations only)</b> Station name (Date)* → Radio text (Date)* → Radio text+ (R.TEXT+) → Music title (Artist) → Music title (Date)* → Frequency (Date)* → (back to the beginning)
CD or USB 1/USB 2	<b>(For CD-DA)</b> Track title (Artist) → Track title (Disc name) → Track title (Date)* → Playing time (Date)* → (back to the beginning) <b>(For MP3/WMA/AAC/WAV/FLAC files)</b> Music title (Artist) → Music title (Album title) → Music title (Date)* → File name (Folder name) → File name (Date)* → Playing time (Date)* → (back to the beginning)
iPod 1/iPod 2/iPod BT or ANDROID 1/ANDROID 2	When [MODE OFF]/[BROWSE MODE] is selected. (→ 11) Music title (Artist) → Music title (Album name) → Music title (Date)* → Playing time (Date)* → (back to the beginning)
PANDORA 1/PANDORA 2/ PANDORA BT	Station name (Date)* → Shared/Radio station (Date)* → Music title (Artist) → Music title (Album title) → Music title (Date)* → Playing time (Date)* → (back to the beginning)
BT AUDIO	Music title (Artist) → Music title (Album name) → Music title (Date)* → Playing time (Date)* → (back to the beginning)
AUX	Source name (Date)*

\* Battery and signal strength of the Bluetooth device will be shown if [BATTERY/SIGNAL] is set to [AUTO]. (→ 17)

# TROUBLESHOOTING

	Symptom	Remedy
General	Sound cannot be heard.	<ul style="list-style-type: none"> <li>Adjust the volume to the optimum level.</li> <li>Check the cords and connections.</li> </ul>
	"MISWIRING CHECK WIRING THEN POWER ON" appears.	Turn the power off, then check to be sure the terminals of the speaker wires are insulated properly. Turn the power on again.
	"PROTECTING SEND TO SERVICE" appears.	Send the unit to the nearest service center.
	<ul style="list-style-type: none"> <li>Sound cannot be heard.</li> <li>The unit does not turn on.</li> <li>Information shown on the display is incorrect.</li> </ul>	Clean the connectors. (→ 26)
	The unit does not work at all.	Reset the unit. (→ 3)
Digital Radio	DAB reception is poor.	Make sure [ON] is selected for [DAB ANT POWER]. (→ 5)
	"DAB ANT ERROR"	Check the DAB antenna. If a passive antenna (without a booster) is used, set [DAB ANT POWER] to [OFF]. (→ 5)
	"RELATED SERVICE FOUND"	<ul style="list-style-type: none"> <li>Press the volume knob to activate Soft-Link. (→ 7)</li> <li>Press <b>Q</b> / <b>↵</b> to cancel.</li> </ul>
Analog Radio	<ul style="list-style-type: none"> <li>Radio reception is poor.</li> <li>Static noise while listening to the radio.</li> </ul>	Connect the antenna firmly.
CD/USB/iPod	Disc cannot be ejected.	Press and hold <b>▲</b> to forcibly eject the disc. Be careful not to drop the disc when it is ejected. If this does not solve the problem, reset the unit. (→ 3)
	Noise is generated.	Skip to another track or change the disc.
	Tracks do not play back as you intended them to play.	Playback order is determined when files are recorded.

	Symptom	Remedy
CD/USB/iPod	"READING" keeps flashing.	Do not use too many hierarchical levels or folders.
	Elapsed playing time is not correct.	This is caused by how the tracks are recorded.
	"LOADING" appears when you enter search mode by pressing <b>Q</b> / <b>↵</b> .	This unit is still preparing the iPod/iPhone music list. It may take some time to load, try again later.
	Correct characters are not displayed (e.g. album name).	<ul style="list-style-type: none"> <li>This unit can only display uppercase letters, numbers, and a limited number of symbols.</li> <li>Depending on the display language you have selected (→ 5), some characters may not be displayed correctly.</li> </ul>
	"NA FILE"	Make sure the disc contains supported audio files. (→ 27)
	"NO DISC"	Insert a playable disc into the loading slot.
	"TOC ERROR"	Make sure the disc is clean and inserted properly.
	"PLEASE EJECT"	Reset the unit. If this does not solve the problem, consult your nearest service center.
	"READ ERROR"	Copy the files and folders onto the USB device again. If this does not solve the problem, reset the USB device or use another USB device.
	"NO DEVICE"	Connect a USB device, and change the source to USB again.
"COPY PROTECTED"	A copy-protected file is played.	
"UNSUPPORTED DEVICE" appears.	<ul style="list-style-type: none"> <li>Check whether the connected device is compatible with this unit and ensure the file systems are in supported formats. (→ 27)</li> <li>Reattach the device.</li> </ul>	

## TROUBLESHOOTING

	Symptom	Remedy
CD/USB/iPod	"UNRESPONSIVE DEVICE" appears.	Make sure the device is not malfunction and reattach the device.
	"USB HUB IS NOT SUPPORTED" appears.	This unit cannot support a USB device connected via a USB hub.
	"NO MUSIC"	Connect a USB device that contains playable audio files.
	"iPod ERROR"	<ul style="list-style-type: none"> <li>Reconnect the iPod.</li> <li>Reset the iPod.</li> </ul>
ANDROID	<ul style="list-style-type: none"> <li>Sound cannot be heard during playback.</li> <li>Sound output only from the Android device.</li> </ul>	<ul style="list-style-type: none"> <li>Reconnect the Android device.</li> <li>If in <b>[HAND MODE]</b>, launch any media player application on the Android device and start playback.</li> <li>If in <b>[HAND MODE]</b>, relaunch the current media player application or use another media player application.</li> <li>Restart the Android device.</li> <li>If this does not solve the problem, the connected Android device is unable to route the audio signal to unit. (➔ 27)</li> </ul>
	Cannot playback at <b>[BROWSE MODE]</b> .	<ul style="list-style-type: none"> <li>Make sure KENWOOD MUSIC PLAY APP is installed on the Android device. (➔ 10)</li> <li>Reconnect the Android device and select the appropriate control mode.</li> <li>If this does not solve the problem, the connected Android device does not support <b>[BROWSE MODE]</b>. (➔ 27)</li> </ul>
	"NO DEVICE" or "READING" keeps flashing.	<ul style="list-style-type: none"> <li>Switch off the developer options on the Android device.</li> <li>Reconnect the Android device.</li> <li>If this does not solve the problem, the connected Android device does not support <b>[BROWSE MODE]</b>. (➔ 27)</li> </ul>
	Playback is intermittent or sound skips.	Turn off the power saving mode on the Android device.
	"ANDROID ERROR"/ "NA DEVICE"	<ul style="list-style-type: none"> <li>Reconnect the Android device.</li> <li>Restart the Android device.</li> </ul>

	Symptom	Remedy
Pandora	"ADD ERROR"	New station creation is unsuccessful.
	"CHECK DEVICE"	Check the Pandora application on your device.
	"NO SKIPS"	The skip limit has been reached.
	"NO STATIONS"	No stations are found.
	"STATION LIMIT"	The number of registered stations has reached its limit. Retry after deleting unnecessary stations from your device.
	"CONNECT ERROR"	Communication is unstable.
	"RATING ERROR"	Registration of thumbs up/thumbs down has failed due to insufficient network connectivity.
Bluetooth®	"THUMBS N/A"	Registration of thumbs up/thumbs down is not allowed.
	"LICENSE ERROR"	You try to access from a country which Pandora is not deliverable.
	No Bluetooth device is detected.	<ul style="list-style-type: none"> <li>Search from the Bluetooth device again.</li> <li>Reset the unit. (➔ 3)</li> </ul>
	Bluetooth pairing cannot be made.	<ul style="list-style-type: none"> <li>Make sure you have entered the same PIN code to both the unit and Bluetooth device.</li> <li>Delete pairing information from both the unit and the Bluetooth device, then perform pairing again. (➔ 14)</li> </ul>
	Echo or noise is heard during a phone conversation.	<ul style="list-style-type: none"> <li>Adjust the microphone unit's position. (➔ 14)</li> <li>Check the <b>[ECHO CANCEL]</b> setting. (➔ 17)</li> </ul>
Phone sound quality is poor.	<ul style="list-style-type: none"> <li>Reduce the distance between the unit and the Bluetooth device.</li> <li>Move the car to a place where you can get a better signal reception.</li> </ul>	

## TROUBLESHOOTING

Symptom	Remedy
Voice calling method is not successful.	<ul style="list-style-type: none"> <li>Use voice calling method in a more quiet environment.</li> <li>Reduce the distance from the microphone when you speak the name.</li> <li>Make sure the same voice as the registered voice tag is used.</li> </ul>
Sound is being interrupted or skipped during playback of a Bluetooth audio player.	<ul style="list-style-type: none"> <li>Reduce the distance between the unit and the Bluetooth audio player.</li> <li>Turn off, then turn on the unit and try to connect again.</li> <li>Other Bluetooth devices might be trying to connect to the unit.</li> </ul>
The connected Bluetooth audio player cannot be controlled.	<ul style="list-style-type: none"> <li>Check whether the connected Bluetooth audio player supports Audio/Video Remote Control Profile (AVRCP). (Refer to the instructions of your audio player.)</li> <li>Disconnect and connect the Bluetooth player again.</li> </ul>
"DEVICE FULL"	The number of registered devices has reached its limit. Retry after deleting an unnecessary device. <b>(→ 19, DEVICE DELETE)</b>
"N/A VOICE TAG"	Make sure the same voice as the registered voice tag is used.
"NOT SUPPORT"	The connected phone does not support Voice Recognition feature or phonebook transfer.
"NO ENTRY"/ "NO PAIR"	There is no registered device connected/found via Bluetooth.
"ERROR"	Try the operation again. If "ERROR" appears again, check if the device supports the function you have tried.
"NO INFO"/"NO DATA"	Bluetooth device cannot get the contact information.
"HF ERROR XX"/ "BT ERROR"	Reset the unit and try the operation again. If this does not solve the problem, consult your nearest service center.

Bluetooth®

## SPECIFICATIONS

Digital radio	DAB	Frequency Range	Band III	174.928 MHz — 239.200 MHz	
		Sensitivity		-100 dBm	
		Signal-to-Noise Ratio		90 dB	
		Antenna Connector Type		SMB	
		Antenna Output Voltage		14.4 V (11 V – 16 V)	
		Antenna Maximum Current		< 100 mA	
Analog radio	FM	Frequency Range		87.5 MHz — 108.0 MHz (50 kHz space)	
		Usable Sensitivity (S/N = 26 dB, Dev 22.5 kHz)		6.2 dBf (0.56 μV/75 Ω)	
		Quieting Sensitivity (S/N = 46 dB, Dev 40kHz)		15.2 dBf (1.58 μV/75 Ω)	
		Frequency Response (±3 dB)		30 Hz — 15 kHz	
		Signal-to-Noise Ratio (MONO)		68.0 dB	
		Stereo Separation (1 kHz)		40 dB	
	AM	Frequency Range	Band 1 (AM)		531 kHz — 1 701 kHz (9 kHz space)
			Band 2 (SW1)		2 940 kHz — 7 735 kHz (5 kHz space)
			Band 3 (SW2)		9 500 kHz — 10 135 kHz/ 11 580 kHz — 18 135 kHz (5 kHz space)
		Channel Space Selection	Band 1		9 kHz
Band 2/ 3				5 kHz	
Usable Sensitivity (S/N = 20 dB)	AM		29.1 dBμ (28.5 μV)		
	SW		30 dBμ (32 μV)		

## SPECIFICATIONS

CD player	Laser Diode	GaAlAs
	Digital Filter (D/A)	8 times over sampling
	Spindle Speed	500 rpm — 200 rpm (CLV)
	Wow & Flutter	Below measurable limit
	Frequency Response ( $\pm 1$ dB)	20 Hz — 20 kHz
	Total Harmonic Distortion (1 kHz)	0.01 %
	Signal-to-Noise Ratio (1 kHz)	105 dB
	Dynamic Range	90 dB
	Channel Separation	85 dB
	MP3 Decode	Compliant with MPEG-1/2 Audio Layer-3
WMA Decode	Compliant with Windows Media Audio	
AAC Decode	AAC-LC “.aac” files	
USB	USB Standard	USB 1.1, USB 2.0 Full Speed
	File System	FAT12/16/32
	Maximum Supply Current	DC 5 V $\pm$ 1.5 A
	MP3 Decode	Compliant with MPEG-1/2 Audio Layer-3
	WMA Decode	Compliant with Windows Media Audio
	AAC Decode	AAC-LC “.aac” files
	WAV Decode	Linear-PCM
	FLAC Decode	FLAC file (Up to 48 kHz/24 bit)

Bluetooth	Version	Bluetooth 3.0	
	Frequency Range	2.402 GHz — 2.480 GHz	
	Output Power	+4 dBm (MAX), 0 dBm (AVE) Power Class 2	
	Maximum Communication Range	Line of sight approx. 10 m (32.8 ft)	
	Profile	HFP 1.6 (Hands-Free Profile) A2DP (Advanced Audio Distribution Profile) AVRCP 1.5 (Audio/Video Remote Control Profile) SPP (Serial Port Profile) PBAP (Phonebook Access Profile)	
Audio	Maximum Output Power	50 W $\times$ 4	
	Full Bandwidth Power	22 W $\times$ 4 (at less than 1 % THD)	
	Speaker Impedance	4 $\Omega$ — 8 $\Omega$	
	Tone Action	Band 1:	62.5 Hz $\pm$ 9 dB
		Band 2:	100 Hz $\pm$ 9 dB
		Band 3:	160 Hz $\pm$ 9 dB
		Band 4:	250 Hz $\pm$ 9 dB
		Band 5:	400 Hz $\pm$ 9 dB
		Band 6:	630 Hz $\pm$ 9 dB
		Band 7:	1 kHz $\pm$ 9 dB
Band 8:		1.6 kHz $\pm$ 9 dB	
Band 9:		2.5 kHz $\pm$ 9 dB	
Band 10:		4 kHz $\pm$ 9 dB	
Band 11:		6.3 kHz $\pm$ 9 dB	
Band 12:		10 kHz $\pm$ 9 dB	
Band 13:		16 kHz $\pm$ 9 dB	
Preout Level/Load (CD)	4 000 mV/10 k $\Omega$		
Preout Impedance	$\leq$ 600 $\Omega$		



## SPECIFICATIONS

Auxiliary	Frequency Response ( $\pm 3$ dB)	20 Hz — 20 kHz
	Input Maximum Voltage	1 000 mV
	Input Impedance	30 k $\Omega$
General	Operating Voltage	14.4 V (10.5 V — 16 V allowable)
	Maximum Current Consumption	10 A
	Operational Temperature Range	-10°C — +60°C
	Installation Size (W $\times$ H $\times$ D)	182 mm $\times$ 53 mm $\times$ 158 mm
Net Weight (includes Trimplate, Mounting Sleeve)	1.3 kg	

Subject to change without notice.

## INSTALLATION/CONNECTION

### ▲ Warning

- The unit can only be used with a 12 V DC power supply, negative ground.
- Disconnect the battery's negative terminal before wiring and mounting.
- Do not connect Battery wire (yellow) and Ignition wire (red) to the car chassis or Ground wire (black) to prevent a short circuit.
- Insulate unconnected wires with vinyl tape to prevent a short circuit.
- Be sure to ground this unit to the car's chassis again after installation.

### ▲ Caution

- For safety's sake, leave wiring and mounting to professionals. Consult the car audio dealer.
- Install this unit in the console of your vehicle. Do not touch the metal parts of this unit during and shortly after use of the unit. Metal parts such as the heat sink and enclosure become hot.
- Do not connect the  $\ominus$  wires of speakers to the car chassis or Ground wire (black), or connect them in parallel.
- Mount the unit at an angle of less than 30°.
- If your vehicle wiring harness does not have the ignition terminal, connect Ignition wire (red) to the terminal on the vehicle's fuse box which provides 12 V DC power supply and is turned on and off by the ignition key.
- Keep all cables away from heat dissipate metal parts.
- After the unit is installed, check whether the brake lamps, blinkers, wipers, etc. on the car are working properly.
- If the fuse blows, first make sure the wires are not touching car's chassis, then replace the old fuse with one that has the same rating.

### Basic procedure

- 1 Remove the key from the ignition switch, then disconnect the  $\ominus$  terminal of the car battery.**
- 2 Install the DAB antenna.**  
See Installing the DAB antenna. (➔ 36)
- 3 Connect the wires properly.**  
See Wiring connection. (➔ 35)
- 4 Install the unit to your car.**  
See Installing the unit (in-dash mounting). (➔ 34)
- 5 Connect the  $\ominus$  terminal of the car battery.**
- 6 Press  $\odot$  SRC to turn on the power.**
- 7 Detach the faceplate and reset the unit. (➔ 3)**

## INSTALLATION/CONNECTION

### Installing the unit (in-dash mounting)

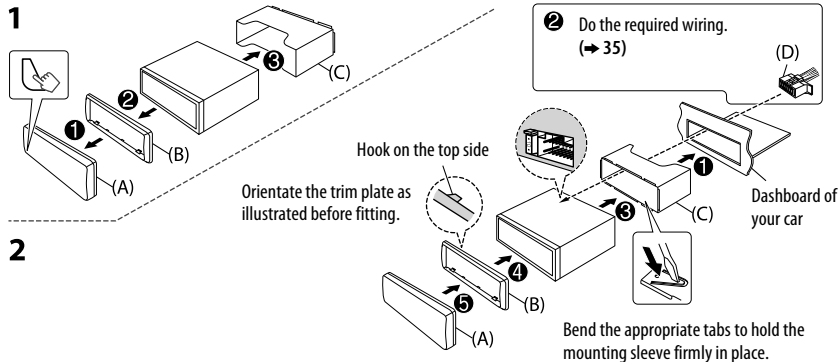

### When installing without the mounting sleeve

- 1 Remove the mounting sleeve and trim plate from the unit.
  - 2 Align the holes in the unit (on both sides) with the vehicle mounting bracket and secure the unit with screws (commercially available).
- ▲ Use only the specified screws. Using wrong screws might damage the unit.

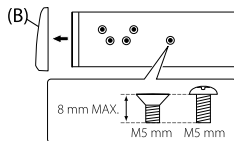

### How to remove the unit

- 1 Detach the faceplate.
- 2 Fit the catch pin on the extraction keys into the holes on both sides of the trim plate, then pull it out.
- 3 Insert the extraction keys deeply into the slots on each side, then follow the arrows as shown on the illustration.

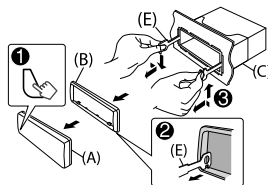

### Part list for installation

#### (A) Faceplate

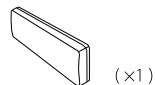

#### (B) Trim plate

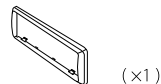

#### (C) Mounting sleeve

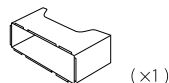

#### (D) Wiring harness

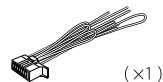

#### (E) Extraction key



# INSTALLATION/CONNECTION

## Wiring connection

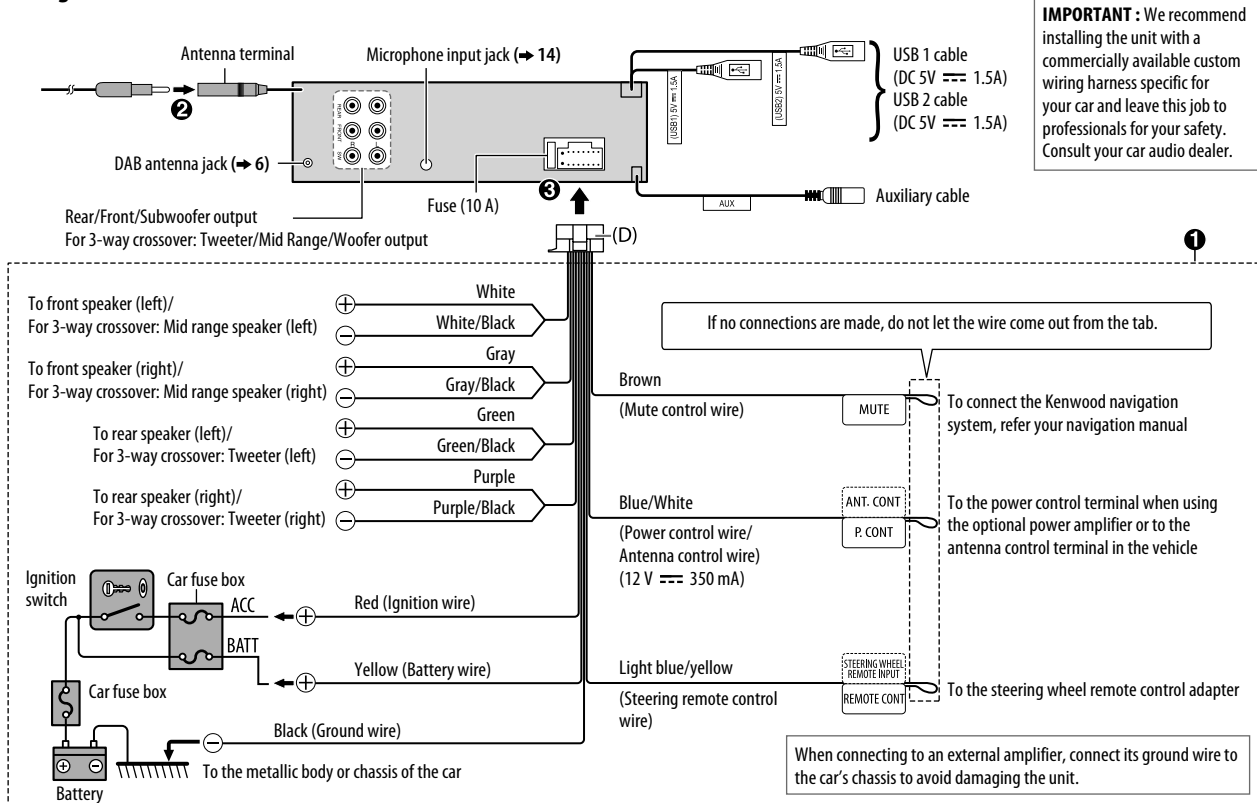

## INSTALLATION/CONNECTION

### Installing the DAB antenna

Connect the supplied DAB antenna to the DAB antenna jack. (→ 35)

#### ▲ Caution

- The film antenna **(F)** is exclusively for use inside the vehicle.
- Do not install at the following locations:
  - where it may block the driver's view.
  - where it may obstruct the operation of safety devices such as air bags.
  - on movable glass surfaces such as the rear hatch.
  - at side of vehicle (e.g. door, front quarter window).
  - on rear window.
- Signal strength will weaken when installed at the following locations:
  - on IR reflecting glass or locations covered with mirror type glass film.
  - where it overlaps with genuine radio antenna (pattern).
  - where it overlaps with window heating wires.
  - on glass that blocks radio signals (e.g. IR reflecting glass, thermal insulation glass).
- Poor reception may occur:
  - due to noise when windscreen wiper, air conditioner, or motor is turned on.
  - depending on the direction of the broadcast station with respect to the vehicle (antenna).
- Thoroughly wipe oil and dirt from the pasting surface with the supplied cleaner **(I)**.
- Do not bend or damage the film antenna **(F)**.
- It may not be possible to install on certain vehicles.
- Check the cable routing of the film antenna **(F)** and amplifier unit **(G)** before pasting.
- Do not apply any glass cleaner after pasting the film antenna **(F)**.

### Determine the antenna installation position

- The direction of the film antenna **(F)** changes depending on whether the film antenna **(F)** is installed on the right side or left side.
- Be sure to check the installation location of film antenna **(F)** before installing. Film antenna cannot be re-pasted.
- Separate from other antennas by at least 100 mm.
- Do not paste the amplifier unit **(G)** on the ceramic line (black part) around the front glass. Because there is not enough adhesion.

#### ■ Installing the antenna on the left side

#### ■ Installing the antenna on the right side

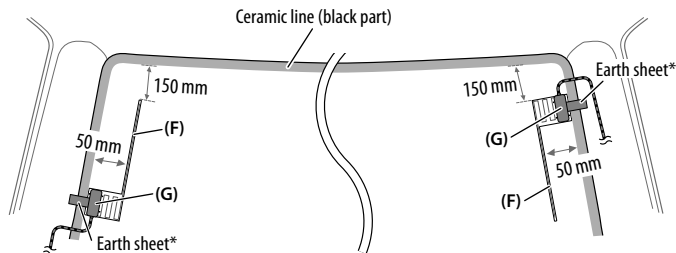

\* Paste the earth sheet of the amplifier unit **(G)** on the metal part of the front pillar.

### Part list for installation

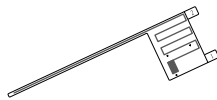

(×1)

**(F)** Film antenna



(×1)

**(G)** Amplifier unit  
(cable with booster, 3.5 m)

(×3)

**(H)** Cable clasper



(×1)

**(I)** Cleaner

## INSTALLATION/CONNECTION

### ▲ Caution

**When installing the antenna cable inside the front pillar with the air bag installed**

- The front pillar cover is secured with a special clip which may need to be replaced when it is removed. Contact your vehicle dealer for details on removing the front pillar cover and availability of replacement parts.

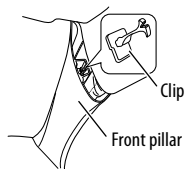

- Install the amplifier unit **(G)** above the air bag so that it does not obstruct the operation of the air bag.

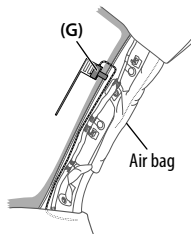

### Installation overview

The antenna should be installed on the passenger side for safety.

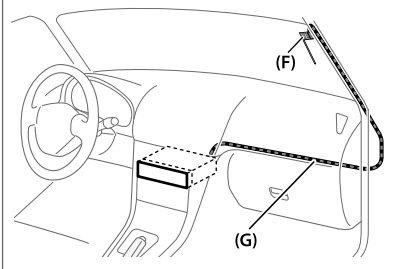

### Antenna installation

- 1 Remove the front pillar cover of your car.**

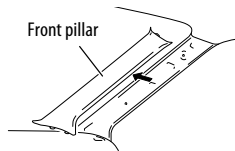

- 2 Clean the windshield with the supplied cleaner **(I)**.**

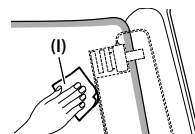

- Wait until the glass surface is completely dry before proceeding.
- Warm the surface of the windshield with defroster if it is cold (during winter).

- 3 Remove the separator (tag 1) of film antenna **(F)** horizontally and paste the antenna on the windshield.**

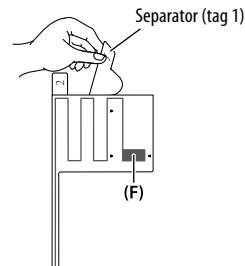

Do not touch the pasting surface (adhesive side) of the film antenna **(F)**.

## INSTALLATION/CONNECTION

- 4** Rub the film antenna gently onto the windscreen in the direction of the arrow shown to allow it to stick firmly.

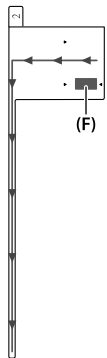

- 5** Remove the separator (tag 2) of film antenna (F) vertically.

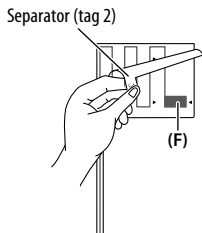

- 6** Set the position of the protrusion of the amplifier unit (G) with the ▼ mark on the film antenna (F) and paste.

Do not touch the lead terminal or the pasting surface (adhesive side) of the amplifier unit (G).

- When installing the antenna on the right side

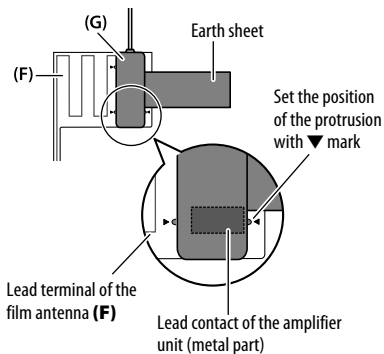

- When installing the antenna on the left side

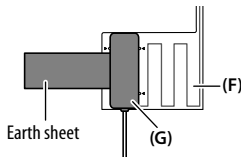

- 7** Remove the film covering the earth sheet and paste the earth sheet on the metal part of the vehicle.

Provide sufficient leeway for the earth sheet so that it does not interfere with the interior parts (front pillar cover). Also take care that the interior parts do not interfere with the amplifier unit (G).

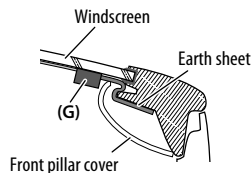

- 8** Wire the antenna cables.

Use cable clumper (H) to secure the antenna to the pillar at several positions.

- 9** Attach the front pillar cover back to its original position.

Be sure not to damage the earth sheet and amplifier unit (G) when covering.

- 10** Connect the amplifier unit (G) to the DAB input terminal on the rear of the unit.

- 11** Set [DAB ANT POWER] to [ON]. (→ 5)





### The marking of products using lasers

The label is attached to the chassis/case and says that the component uses laser beams that have been classified as Class 1. It means that the unit is utilizing laser beams that are of a weaker class. There is no danger of hazardous radiation outside the unit.

- “Made for iPod,” and “Made for iPhone” mean that an electronic accessory has been designed to connect specifically to iPod, or iPhone, respectively, and has been certified by the developer to meet Apple performance standards. Apple is not responsible for the operation of this device or its compliance with safety and regulatory standards. Please note that the use of this accessory with iPod or iPhone may affect wireless performance.
- iPhone, iPod, iPod classic, iPod nano, and iPod touch are trademarks of Apple Inc., registered in the U.S. and other countries.
- Lightning is a trademark of Apple Inc.
- Pandora, the Pandora logo, and the Pandora trade dress are trademarks or registered trademarks of Pandora Media, Inc., used with permission.
- Google, Google Play and Android are trademarks of Google Inc.
- The “AAC” logo is a trademark of Dolby Laboratories.
- The Bluetooth® word mark and logos are registered trademarks owned by Bluetooth SIG, Inc. and any use of such marks by JVC KENWOOD Corporation is under license. Other trademarks and trade names are those of their respective owners.
- The N-Mark is a trademark or registered trademark of NFC Forum, Inc. in the United States and in other countries.

### libFLAC

Copyright (C) 2000,2001,2002,2003,2004,2005,2006,2007,2008,2009 Josh Coalson

Redistribution and use in source and binary forms, with or without modification, are permitted provided that the following conditions are met:

- Redistributions of source code must retain the above copyright notice, this list of conditions and the following disclaimer.
  - Redistributions in binary form must reproduce the above copyright notice, this list of conditions and the following disclaimer in the documentation and/or other materials provided with the distribution.
  - Neither the name of the Xiph.org Foundation nor the names of its contributors may be used to endorse or promote products derived from this software without specific prior written permission.
- THIS SOFTWARE IS PROVIDED BY THE COPYRIGHT HOLDERS AND CONTRIBUTORS “AS IS” AND ANY EXPRESS OR IMPLIED WARRANTIES, INCLUDING, BUT NOT LIMITED TO, THE IMPLIED WARRANTIES OF MERCHANTABILITY AND FITNESS FOR A PARTICULAR PURPOSE ARE DISCLAIMED. IN NO EVENT SHALL THE FOUNDATION OR CONTRIBUTORS BE LIABLE FOR ANY DIRECT, INDIRECT, INCIDENTAL, SPECIAL, EXEMPLARY, OR CONSEQUENTIAL DAMAGES (INCLUDING, BUT NOT LIMITED TO, PROCUREMENT OF SUBSTITUTE GOODS OR SERVICES; LOSS OF USE, DATA, OR PROFITS; OR BUSINESS INTERRUPTION) HOWEVER CAUSED AND ON ANY THEORY OF LIABILITY, WHETHER IN CONTRACT, STRICT LIABILITY, OR TORT (INCLUDING NEGLIGENCE OR OTHERWISE) ARISING IN ANY WAY OUT OF THE USE OF THIS SOFTWARE, EVEN IF ADVISED OF THE POSSIBILITY OF SUCH DAMAGE.