

# KENWOOD

**DDX4017DAB**  
**DDX4017BT**

**DDX4017BTR**  
**DDX317BT**

---

MONITOR WITH DVD RECEIVER  
**INSTRUCTION MANUAL**

JVC KENWOOD Corporation



# CONTENTS

<b>BEFORE USE</b> .....	<b>2</b>	<b>OTHER EXTERNAL COMPONENTS</b> .....	<b>34</b>
How to reset your unit.....	3	Using the rear view camera.....	34
<b>INITIAL SETTINGS</b> .....	<b>4</b>	Using external audio/video players—AV-IN .....	36
Initial setup.....	4	Using the external navigation unit .....	37
Setting the security function .....	4	<b>BLUETOOTH</b> .....	<b>38</b>
Clock settings .....	5	<b>SETTINGS</b> .....	<b>46</b>
<b>BASICS</b> .....	<b>6</b>	Settings for using applications of iPod touch/ iPhone/Android .....	46
Component names and functions .....	6	Sound adjustment .....	47
Common operations.....	7	Adjustment for video playback.....	50
Common screen operations.....	8	Changing the display design .....	51
Selecting the playback source.....	10	Customizing the Home screen.....	53
Using short-cut buttons.....	11	Customizing the system settings .....	53
<b>DISCS</b> .....	<b>12</b>	Setting menu items.....	55
<b>USB</b> .....	<b>17</b>	<b>REMOTE CONTROLLER</b> .....	<b>59</b>
<b>Android</b> .....	<b>19</b>	<b>CONNECTION/INSTALLATION</b> .....	<b>62</b>
<b>iPod/iPhone</b> .....	<b>21</b>	<b>REFERENCES</b> .....	<b>68</b>
<b>APPS</b> .....	<b>24</b>	Maintenance .....	68
<b>Spotify</b> .....	<b>25</b>	More information .....	68
<b>RADIO</b> .....	<b>27</b>	Error message list .....	72
<b>DIGITAL RADIO (DAB)</b> .....	<b>30</b>	Troubleshooting .....	72
		Specifications.....	74

## How to read this manual:

- Illustrations of DDX4017BT are mainly used for explanation. The displays and panels shown in this manual are examples used to provide clear explanations of the operations. For this reason, they may be different from the actual displays or panels.
- This manual mainly explains operations using the buttons on the monitor panel and touch panel. For operations using the remote controller (KNA-RCDV331: separately purchased), see page 59.
- < > indicates the various screens/menus/operations/settings that appear on the touch panel.
- [ ] indicates the buttons on the touch panel.
- **Indication language:** English indications are used for the purpose of explanation. You can select the indication language from the <Setup> menu. (Page 58)
- Updated information (the latest Instruction Manual, system updates, new functions, etc.) is available from <<http://www.kenwood.com/cs/ce/>>.

# BEFORE USE

## IMPORTANT

To ensure proper use, please read through this manual before using this product. It is especially important that you read and observe WARNINGS and CAUTIONS in this manual. Please keep the manual in a safe and accessible place for future reference.

### ⚠ **WARNINGS: (To prevent accidents and damage)**

- DO NOT install any unit or wire any cable in a location where;
  - it may obstruct the steering wheel and gearshift lever operations.
  - it may obstruct the operation of safety devices such as air bags.
  - it may obstruct visibility.
- DO NOT operate the unit while driving. If you need to operate the unit while driving, be sure to look around carefully.
- The driver must not watch the monitor while driving.

### The marking of products using lasers

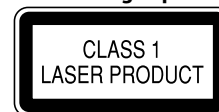

The label is attached to the chassis/case and says that the component uses laser beams that have been classified as Class 1. It means that the unit is utilizing laser beams that are of a weaker class. There is no danger of hazardous radiation outside the unit.

## BEFORE USE

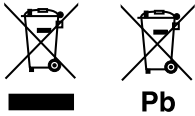

### Information on Disposal of Old Electrical and Electronic Equipment and Batteries (applicable for countries that have adopted separate waste collection systems)

Products and batteries with the symbol (crossed-out wheeled bin) cannot be disposed as household waste.

Old electrical and electronic equipment and batteries should be recycled at a facility capable of handling these items and their waste byproducts. Contact your local authority for details in locating a recycle facility nearest to you.

Proper recycling and waste disposal will help conserve resources whilst preventing detrimental effects on our health and the environment.

Notice: The sign "Pb" below the symbol for batteries indicates that this battery contains lead.

### For Israel

מידע בדבר השלכה לאשפה של ציוד חשמלי ואלקטרוני ישן וכן סוללות (רלוונטי למדינות שמשמשות במערכת איסוף אשפה מופרדת).

לא ניתן להשליך מוצרים וסוללות עם הסימון (פח אשפה עם X עליו) כאשפה ביתית רגילה. יש למחזר ציוד חשמלי ואלקטרוני ישן וכן סוללות במתקן המסוגל לטפל בפריטים כאלה ובתוצרי הלוואי שלהם.

צרו קשר עם הרשות המקומית לקבלת פרטים אודות מתקן המיחזור הקרוב אליכם. מיחזור והשלכה לאשפה נאותים יעזרו לשמר משאבים ולמנוע השפעות שליליות על בריאותנו ועל הסביבה.

שימו לב: הסימון Pb שמתחת לסימון עבור סוללות מצייין שהסוללה מכילה עופרת.

### ⚠ Cautions on the monitor:

- The monitor built into this unit has been produced with high precision, but it may have some ineffective dots. This is inevitable and is not considered defective.
- Do not expose the monitor to direct sunlight.
- Do not operate the touch panel using a ball-point pen or similar tool with a sharp tip.  
Touch the buttons on the touch panel with your finger directly (if you are wearing a glove, take it off).
- When the temperature is very cold or very hot...
  - Chemical changes occur inside, causing malfunction.
  - Pictures may not appear clearly or may move slowly. Pictures may not be synchronized with the sound or picture quality may decline in such environments.

### For safety...

- Do not raise the volume level too much, as this will make driving dangerous by blocking outside sounds, and may cause hearing loss.
- Stop the car before performing any complicated operations.

### Temperature inside the car...

If you have parked the car for a long time in hot or cold weather, wait until the temperature in the car becomes normal before operating the unit.

### 🔧 How to reset your unit

If the unit fails to operate properly, press the reset button.



# INITIAL SETTINGS

## Initial setup

When you power on the unit for the first time or reset the unit, the initial setting screen appears.

- You can also change the settings on the **<Setup>** screen. (Page 55)

### 1 Perform the initial settings.

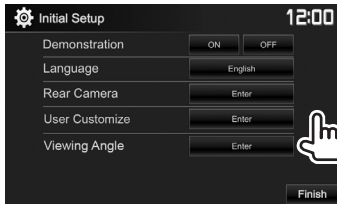

**<Demonstration>** Activate or deactivate the display demonstration. (Page 57)

**<Language>** Select the text language used for on-screen information. (Page 58)

- Set **<GUI Language>** to display the operation buttons and menu items in the selected language (**[Local]**) or English (**[English]**).

**<Rear Camera>** (Page 34)

Configure the settings to display the picture from the connected rear view camera.

**<User Customize>** (Page 51)

Change the display design.

**<Viewing Angle>** (Page 57)

Select the viewing angle in relation to the monitor panel to make the panel easier to see.

### 2 Finish the procedure.



The Home screen is displayed.

## Setting the security function

### Registering a security code

You can set a security code to protect your receiver system against theft.

### 1 Display the Home screen. On the monitor panel:



### 2 Display the **<System>** setting screen.

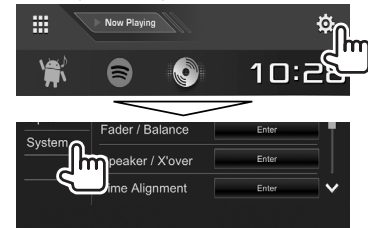

### 3 Display the **<Security Code Set>** screen.

- You can change the page to display more items by pressing **[^]**/**[v]**.



### 4 Enter a four-digit number (①), then confirm the entry (②).

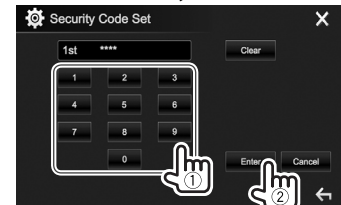

- Press **[Clear]** to delete the last entry.
- Press **[Cancel]** to cancel the setting.
- Press **[X]** to return to the current source control screen.

### 5 Repeat step 4 to confirm your security code.

Now, your security code is registered.



## INITIAL SETTINGS

- To clear the registered security code, perform steps **1** and **2**.  
On step **3**, press **[CLR]** to display **<Security Code>** screen. Then, enter the current security code to clear and press **[Enter]**.
- When the unit has been reset or disconnected from the battery, you are required to enter the security code. Enter the correct security code, then press **[Enter]**.

### ❑ Activating the security function

You can activate the security function to protect your receiver system against theft.

- Display the **<System>** setting screen.  
On the Home screen:
  - You can change the page to display more items by pressing **[▲]/[▼]**.



The security function is activated.  
The security indicator on the monitor panel flashes when the vehicle ignition is off.

**To deactivate the security function:** Select **[OFF]** for **<SI>**.

### Clock settings

- Display the Home screen.  
On the monitor panel:



- Display the **<Clock>** screen.

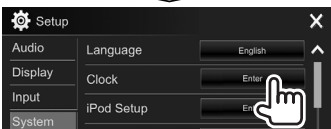
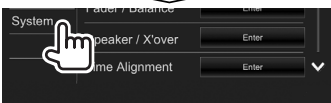
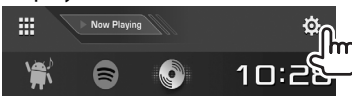

- You can also display the **<Clock>** setting screen by touching the clock area on the Home screen.

- Set the clock time.

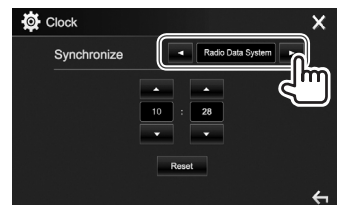

**<NAV>**\*1 Synchronizes the clock time with the connected navigation unit.

**<Radio Data System>**\*2 Synchronizes the clock time with FM Radio Data System.

**<DAB>**\*3 Synchronizes the clock time with the digital radio (DAB).

**<OFF>** Sets the clock manually. (See below.)

When selecting **<OFF>**:  
Adjust the hour (①), then adjust the minute (②).  
• Press **[Reset]** to set the minute to "00".

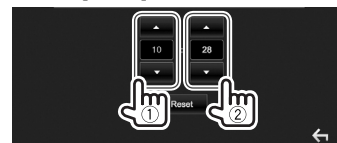

- Finish the procedure.



\*1 Only for DDX4017DAB/DDX4017BT: Appears only when a navigation unit is connected.

\*2 Only for DDX4017BT/DDX4017BTR/DDX317BT.

\*3 Only for DDX4017DAB.

# BASICS

## Component names and functions

### ⚠ Caution on the volume setting:

Digital devices produce very little noise compared with other sources. Lower the volume before playing these digital sources to avoid damaging the speakers by sudden increase of the output level.

### DDX4017DAB/DDX4017BT/DDX4017BTR

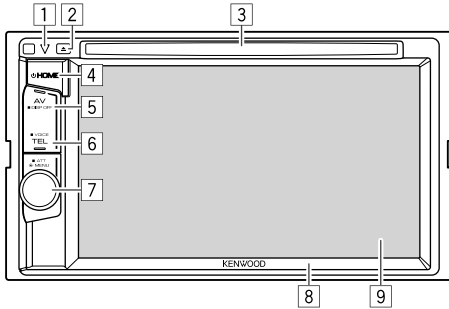

- 1 Reset button/Power indicator/Security indicator
  - Resets the unit. (Page 3)
  - Lights up while the unit is turned on.
  - Flashes when the security function is activated. (Page 5)
- 2 ▲ (Eject) button
  - Ejects the disc. (Page 12)
- 3 Loading slot
- 4 HOME button
  - Displays the Home screen. (Press) (Page 8)
  - Turns on the power. (Press) (Page 7)
  - Turns off the power. (Hold) (Page 7)

- 5 AV/DISP OFF button
  - Displays the current source screen. (Press)
    - For DDX4017DAB/DDX4017BT: When the navigation box is connected, the screen is switched between the current source and the navigation screen. (Page 37)
  - Turns off the screen. (Hold) (Page 8)
- 6 TEL/VOICE button
  - Displays the phone control screen. (Press) (Page 42)
  - Activates voice dialing. (Hold) (Page 43)
- 7 Volume/MENU/ATT knob
  - Adjusts the audio volume. (Turn) (Page 7)
  - Pops up the short-cut menu. (Press) (Page 11)
  - Attenuates the sound. (Hold) (Page 7)
- 8 Monitor panel\*
- 9 Screen (touch panel)

\* You can change the color of the buttons on the monitor panel. (Page 51)

### DDX317BT

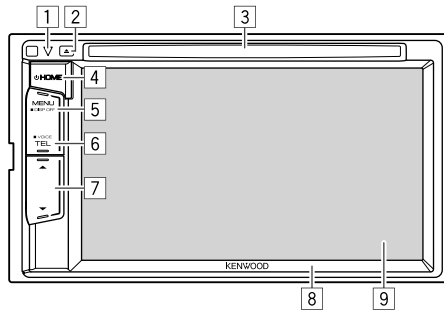

- 1 Reset button/Power indicator/Security indicator
  - Resets the unit. (Page 3)
  - Lights up while the unit is turned on.
  - Flashes when the security function is activated. (Page 5)
- 2 ▲ (Eject) button
  - Ejects the disc. (Page 12)
- 3 Loading slot
- 4 HOME button
  - Displays the Home screen. (Press) (Page 8)
  - Turns on the power. (Press) (Page 7)
  - Turns off the power. (Hold) (Page 7)
- 5 MENU/DISP OFF button
  - Pops up the short-cut menu. (Press) (Page 11)
  - Turns off the screen. (Hold) (Page 8)
- 6 TEL/VOICE button
  - Displays the phone control screen. (Press) (Page 42)
  - Activates voice dialing. (Hold) (Page 43)
- 7 Volume ▼/▲ buttons
  - Adjusts the audio volume. (Page 7)
- 8 Monitor panel
- 9 Screen (touch panel)

## BASICS

### Common operations

#### Turning on the power



#### Turning off the power

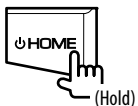

#### Adjusting the volume

To adjust the volume (00 to 35)

DDX4017DAB/  
DDX4017BT/  
DDX4017BTR

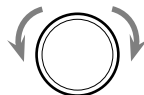

Turn to the right to increase, and turn to the left to decrease.

DDX317BT

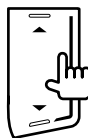

Press ▲ to increase, and press ▼ to decrease.

- Holding ▲ increases the volume continuously to level 15.

To attenuate the sound (only for DDX4017DAB/  
DDX4017BT/DDX4017BTR)



The ATT indicator lights up.

**To cancel the attenuation:** Press the same button again.

## BASICS

### ❑ Putting the unit in standby

- 1 Display all playback sources and items.  
On the Home screen:



2

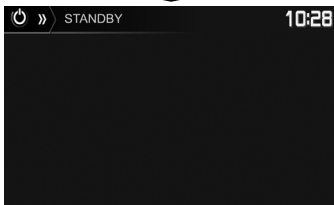
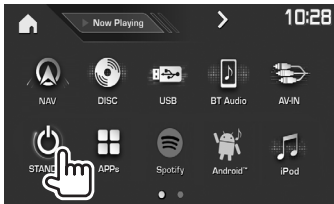

### ❑ Turning off the screen

On the pop-up short-cut menu (Page 11):  
Display the pop-up short-cut menu by pressing MENU on the monitor panel, then select [Display OFF].



On the monitor panel:

**DDX4017DAB/  
DDX4017BT/  
DDX4017BTR**

**DDX317BT**

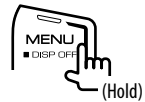
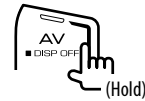

**To turn on the screen:** Press and hold the same button, or touch the display.

## Common screen operations

### ❑ Common screen descriptions

You can display other screens at any time to change the source, show the information, or change the settings, etc.

### Source control screen

Performs source playback operations.

- The operation buttons and information displayed vary depending on the selected source.

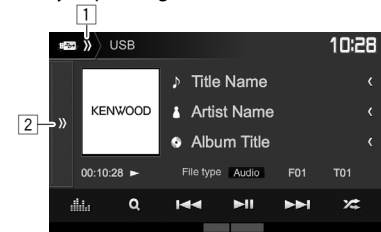

### Common operating buttons:

- 1 Displays/hides short-cut source selection buttons. (Page 11)
- 2 Displays the other operation button window.\*

\* Does not appear when there are no other operation buttons other than those currently shown on the source control screen.

## BASICS

### Home screen

Displays the source control screen and settings screen.

- To display the Home screen, press HOME on the monitor panel.
- You can arrange the items to display on the Home screen. (Page 53)



### Common operating buttons:

- 1 Displays all playback sources and items. (Page 10)
- 2 Displays the source currently played back.
- 3 Displays the <Setup> screen. (See the right column.)
- 4 Changes the playback source. (Page 10)
- 5 Displays the <Clock> setting screen. (Page 5)

### <Setup> screen

Changes the detailed settings. (Page 55)

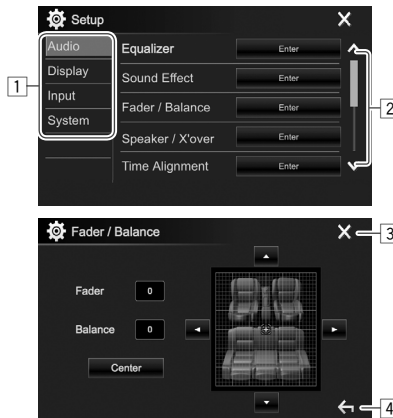

### Common operating buttons:

- 1 Selects the menu category.
- 2 Changes the page.
- 3 Closes the current setting screen and returns to the current source control screen.
- 4 Returns to the previous screen.

### Touch screen operations

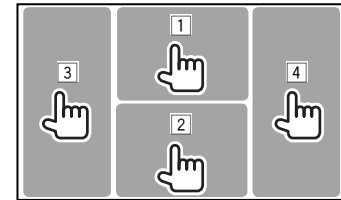

- 1 Displays the video control menu while playing a video.

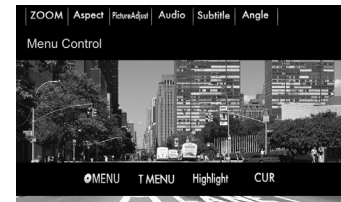

- 2 Displays the source control screen while playing a video.

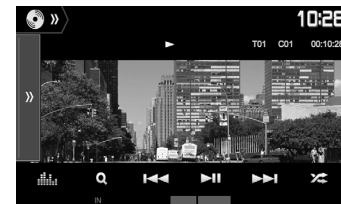

- The operation buttons disappear when the screen is touched or when no operation is done for about 5 seconds.
- 3 Goes to the previous chapter/track.\*
- 4 Goes to the next chapter/track.\*

\* Not available for video from an external component.

## BASICS

### Selecting the playback source

On the Home screen:

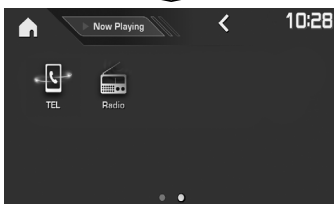
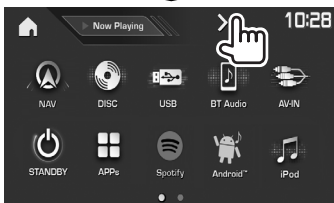
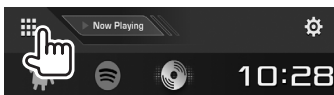

- You can change the page to display more items by pressing [**◀**]/[**▶**].
  - The current page is indicated by the page indicator at the bottom of the screen.

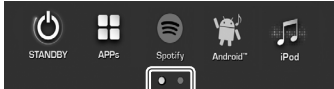

[NAV]\*<sup>1</sup>

Displays the navigation screen when a navigation unit is connected. (Page 37)

[DISC]

Plays a disc. (Page 12)

[USB]

Plays files on a USB device. (Page 17)

[BT Audio]

Plays a Bluetooth audio player. (Page 44)

[AV-IN]\*<sup>2</sup>

Switches to an external component connected to the iPod/AV-IN input terminal. (Page 36)

[STANDBY]

Puts the unit in standby. (Page 8)

[APPs]

Switches to the App screen from the connected iPod touch/iPhone/Android device. (Page 24)

[Spotify]\*<sup>3</sup>

Switches to the Spotify application. (Page 25)

[Android™]\*

Plays an Android device. (Page 19)

[iPod]

Plays an iPod/iPhone. (Page 21)

[TEL]

Displays the phone control screen. (Page 42)

[DAB]\*<sup>4</sup>

Switches to the digital audio broadcast (DAB). (Page 30)

[Radio]

Switches to the radio broadcast. (Page 27)

To return to the Home screen

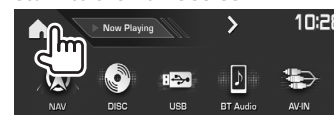

\*<sup>1</sup> Only for DDX4017DAB/DDX4017BT: Not selectable when no navigation is connected.

\*<sup>2</sup> Selectable only when connection method other than [USB + AV-IN] is selected for <iPod Setup>. (Page 21)

\*<sup>3</sup> Only for DDX4017DAB/DDX4017BT/DDX317BT.

\*<sup>4</sup> Only for DDX4017DAB.

□ Selecting the playback source on the Home screen



- You can arrange the items to display on the Home screen. (Page 53)

## BASICS

### Using short-cut buttons

#### Using short-cut source selection buttons

While displaying the source control screen, you can use the short-cut buttons to go to the items on the Home screen indicated below.

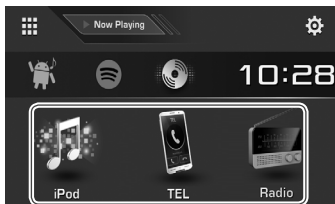

#### To display the short-cut source selection buttons

On the source control screen:

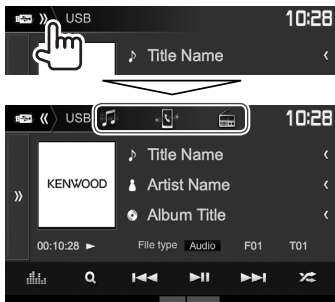

#### To hide the short-cut buttons

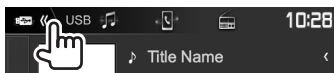

#### Using the pop-up short-cut menu

While displaying the source control screen, you can jump to another screen from the pop-up short-cut menu.

##### 1 Display the pop-up short-cut menu.

**DDX4017DAB/DDX4017BT/  
DDX4017BTR**



**DDX317BT**



##### 2 Select an item to jump to.

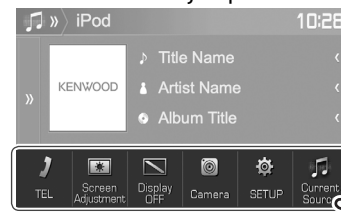

##### [TEL]

Displays the phone control screen. (Page 42)

##### [Screen Adjustment]

Displays the picture adjustment screen. (Page 50)

##### [Display OFF]

Turns off the screen. (Page 8)

##### [Camera]

Displays the picture from the rear view camera. (Page 34)

##### [SETUP]

Displays the <Setup> screen. (Page 55)

##### [Current Source]

Displays the current source control screen.

**To close the pop-up menu:** Touch the screen anywhere other than the pop-up short-cut menu.

# DISCS

## Playing a disc

- If a disc does not have a disc menu, all tracks on it will be played repeatedly until you change the source or eject the disc.
- For playable disc types/file types, see page 69.

## Inserting a disc

Insert a disc with the label side facing up.

**DDX4017DAB/  
DDX4017BT/  
DDX4017BTR**

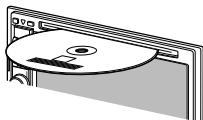

**DDX317BT**

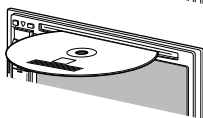

The source changes to **"DISC"** and playback starts.

- The IN indicator lights up while a disc is inserted.

- If "⊘" appears on the screen, the unit cannot accept the operation you have tried to do.
  - In some cases, without showing "⊘," operations will not be accepted.
- When playing back a multi-channel encoded disc, the multi-channel signals are downmixed to stereo.

## Ejecting a disc



When removing a disc, pull it horizontally.

- You can eject a disc when playing another AV source.
- If the ejected disc is not removed within 15 seconds, the disc is automatically inserted again into the loading slot to protect it from dust.

## Playback operations

When the operation buttons are not displayed on the screen, touch the area shown on the illustration.

- To change settings for video playback, see page 50.

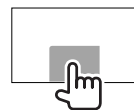

## Indications and buttons on the source control screen

For video playback

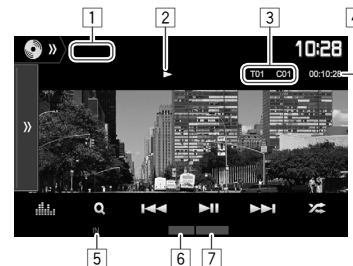

### Playback information

- The information displayed on the screen differs depending on the type of disc/file being played back.

- 1 Media type
- 2 Playback status
- 3 Current playback item information (title no./chapter no./folder no./file no./track no.)
- 4 Playing time
- 5 IN indicator
- 6 Playback mode (Page 15)
- 7 File type



## DISCS

### Operation buttons

- Available buttons on the screen and operations differ depending on the type of disc/file being played back.

[>>] Displays the other operation button window.

- To hide the window, press [≪≪].

[|||||] Displays the <Equalizer> screen. (Page 47)

[Q] Displays the folder/track list. (Page 14)

[◀◀] [▶▶] • Selects a chapter/track. (Press)  
• Reverse/forward search. (Hold)  
• Plays in slow-motion during pause. (Hold)

[▶||] Starts/pauses playback.

[X] Selects Random playback mode. (Page 15)

[📁] [➕] Selects a folder.

[🔄] Selects Repeat playback mode. (Page 15)

[■] Stops playback.

[MODE] Changes the settings for disc playback on the <DISC Mode> screen. (Page 16)

### For audio playback

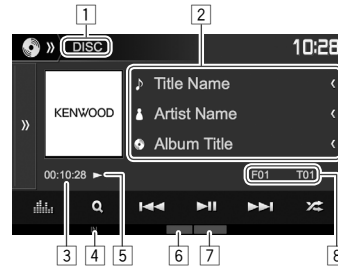

### Playback information

- The information displayed on the screen differs depending on the type of disc/file being played back.

- 1 Media type
- 2 Track/file information
  - Pressing [◀] scrolls the text if not all of the text is shown.
- 3 Playing time
- 4 IN indicator
- 5 Playback status
- 6 Playback mode (Page 15)
- 7 File type
- 8 Current playback item information (folder no./file no./track no.)

### Operation buttons

- Available buttons on the screen and operations differ depending on the type of disc/file being played back.

[>>] Displays the other operation button window.

- To hide the window, press [≪≪].

[|||||] Displays the <Equalizer> screen. (Page 47)

[Q] Displays the folder/track list. (Page 14)

[◀◀] [▶▶] • Selects a track. (Press)  
• Reverse/forward search. (Hold)

[▶||] Starts/pauses playback.

[■] Stops playback.

[X] Selects Random playback mode. (Page 15)

[📁] [➕] Selects a folder.

[🔄] Selects Repeat playback mode. (Page 15)

[MODE] Changes the settings for disc playback on the <DISC Mode> screen. (Page 16)

# DISCS

## ❑ Selecting a folder/track on the list

1

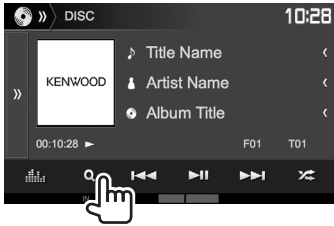

2 Select the folder (①), then the item in the selected folder (②).

- Repeat the procedure until you select the desired track.

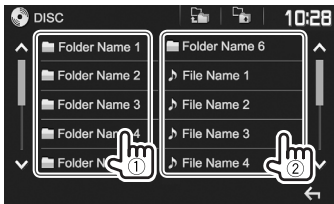

- You can change the page to display more items by pressing [▲]/[▼].
- Press [⏪] to return to the root folder.
- Press [⏩] to return to the upper layer.

## ❑ Video menu operations

You can display the video control menu during video playback.

- The operation buttons disappear when the screen is touched or when no operation is done for about 5 seconds.

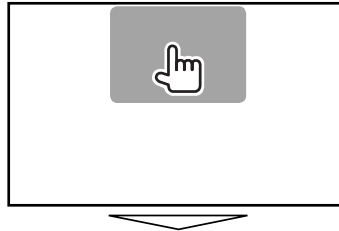

### For video playback except VCD

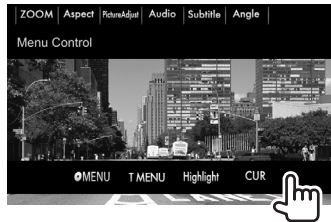

- Available buttons on the screen and operations differ depending on the type of disc/file being played back.

[MENU]  
[T MENU]  
[Highlight]

Displays the disc menu (DVD).  
Displays the disc menu (DVD).  
Switches to the direct disc menu mode. Touch the target item to select.

- To restore the screen, press [←].

[CUR]

Displays the menu/scene selection screen.

- [▲][▼][◀][▶]: Selects an item.
- [Enter]: Confirms the selection.
- [Return]: Returns to the previous screen.

[ZOOM]

Displays the picture size selection screen. (Page 51)

[Aspect]

Selects the aspect ratio. (Page 50)

[PictureAdjust]

Displays the picture adjustment screen. (Page 50)

[Audio]

Selects the audio type.

[Subtitle]

Selects the subtitle type.

[Angle]

Selects the view angle.

# DISCS

## For VCD

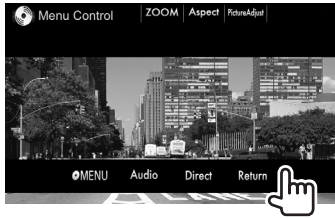

**[MENU]**

Displays the disc menu.

**[Audio]**

Selects the audio channel (ST: stereo, L: left, R: right).

**[Direct]**

Displays/hides the direct selection buttons. (See the right column.)

**[Return]**

Displays the previous screen or menu.

**[ZOOM]**

Displays the picture size selection screen. (Page 51)

**[Aspect]**

Selects the aspect ratio. (Page 50)

**[PictureAdjust]**

Displays the picture adjustment screen. (Page 50)

### To select a track directly on a VCD

- When playing a VCD with PBC activated, stop playback to deactivate the PBC function, then use the direct selection buttons to select a track number.



- When you enter a wrong number, press **[DIR/CLR]** to delete the last entry.

### Selecting playback mode

#### To select Repeat playback mode

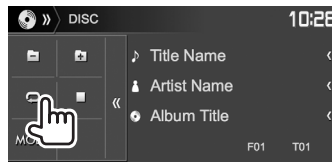
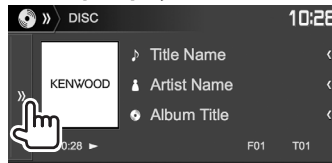

### To select Random playback mode



- The locations of the buttons differ depending on the type of disc/file being played back.
  - When **[PBC]** is not displayed, display the other operation button window by pressing **[>>]**.
- Available playback modes differ depending on the type of disc/file being played back.
- You cannot activate the repeat mode and the random mode at the same time.
- Each time you press the button, the playback mode changes. (The corresponding indicator lights up.)
  - Available items differ depending on the type of disc/file being played back.

**C-REP**

Repeats current chapter.

**T-REP**

Repeats current title/program.

**REP**

Repeats current track.

**FO-REP**

Repeats all tracks of the current folder.

**FO-RDM**

Randomly plays all tracks of the current folder, then tracks of the next folders.

**RDM**

Randomly plays all tracks.

**To cancel Repeat/Random playback:** Press the button repeatedly until the indicator disappears.

## DISCS

### Settings for disc playback—<DISC Mode>

1

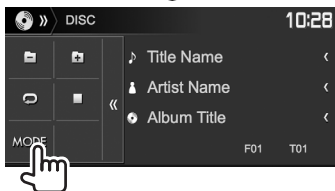
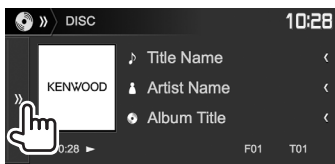

2



- You can change the page to display more items by pressing [**▲**]/[**▼**].
- Available items shown on the <DISC Mode> screen differ depending on the type of disc/file being played back.

### □ Setting items

<Menu Language>	Select the initial disc menu language. (Initial: <b>English</b> ) (Page 71)
<Subtitle Language>	Select the initial subtitle language or turn subtitles off ( <b>Off</b> ). (Initial: <b>English</b> ) (Page 71)
<Audio Language>	Select the initial audio language. (Initial: <b>English</b> ) (Page 71)
<Dynamic Range Control>	You can change the dynamic range while playing using Dolby Digital software. <ul style="list-style-type: none"> <li>• <b>Wide</b>: Select this to enjoy a powerful sound at a low volume level with its full dynamic range.</li> <li>• <b>Normal</b>: Select this to reduce the dynamic range a little.</li> <li>• <b>Dialog</b> (Initial): Select this to reproduce movie dialog more clearly.</li> </ul>

<Down Mix>	When playing back a multi-channel disc, this setting affects the signals reproduced through the front and/or rear speakers. <ul style="list-style-type: none"> <li>• <b>Dolby Surround</b>: Select this to enjoy multi-channel surround sound by connecting an amplifier compatible with Dolby Surround.</li> <li>• <b>Stereo</b> (initial): Normally select this.</li> </ul>
<Screen Ratio>	Select the monitor type to watch a wide screen picture on the external monitor. <p><b>16:9</b> (Initial)   <b>4:3 LB</b>   <b>4:3 PS</b></p> 
<File Type>*	Select the playback file type when a disc contains different types of files. <ul style="list-style-type: none"> <li>• <b>Audio</b>: Plays back audio files.</li> <li>• <b>Still Image</b>: Plays back picture files.</li> <li>• <b>Video</b>: Plays back video files.</li> <li>• <b>Audio&amp;Video</b> (initial): Plays back audio files and video files.</li> </ul>

- \* For playable file types, see page 69.
- If the disc contains no files of the selected type, the existing files are played in the following priority: audio, video, then still picture. You can change these settings only while playback is stopped.

# USB

## Connecting a USB device

You can connect a USB mass storage class device such as a USB memory, Digital Audio Player etc. to the unit.

- For details about connecting USB devices, see page 65.
- You cannot connect a computer or portable HDD to the USB input terminal.
- You cannot connect a USB device via a USB hub.
- For playable file types and notes on using USB devices, see page 70.

### When a USB device is connected...

- The source changes to “USB” and playback starts.
- All tracks in the USB device will be played repeatedly until you change the source.

## Playback operations

When the operation buttons are not displayed on the screen, touch the area shown on the illustration.

- To change settings for video playback, see page 50.

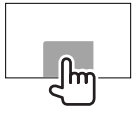

## Indications and buttons on the source control screen

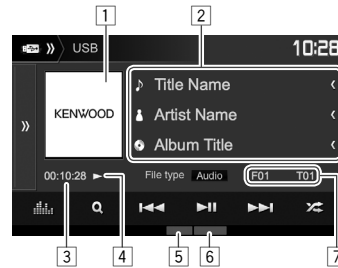

### Playback information

- The information displayed on the screen differs depending on the type of file being played back.
- 1 Jacket picture (Shown while playing if the file has tag data that includes the jacket picture)
  - 2 Track/file information
    - Pressing [**<**] scrolls the text if not all of the text is shown.
  - 3 Playing time
  - 4 Playback status
  - 5 Playback mode (See the right column.)
  - 6 File type
  - 7 Current playback item information (folder no./file no.)

### Operation buttons

- Available buttons on the screen and operations differ depending on the type of file being played back.



Displays the other operation button window.

- To hide the window, press [**<<<**].

[**Audio**]/  
[**Video**]/  
[**Photo**]

- Selects the playback file type.\*1
- **Audio**: Plays back audio files.
  - **Video**: Plays back video files.
  - **Photo**: Plays back picture files.



Displays the **<Equalizer>** screen. (Page 47)



Displays the folder/track list. (Page 18)



- Selects a track. (Press)
- Reverse/forward search. (Hold)



Starts/pauses playback.



Selects random playback mode.\*2 \*3

- **FO-RDM**: Randomly plays all tracks/files in the folder.
  - **RDM**: Randomly plays all tracks/files.
- Selects a folder.



Selects repeat playback mode.\*2 \*3

- **REP**: Repeats the current track/file.
- **FO-REP**: Repeats all tracks/files in the current folder.

[**MODE**]

Changes the settings for USB playback on the **<USB Mode>** screen. (Page 18)

\*1 For playable file types, see page 70.

If the USB contains no files of the selected type, the existing files are played in the following priority: audio, video, then still picture. You can change these settings only while playback is stopped.

\*2 To cancel random or repeat mode, press the button repeatedly until the indicator disappears.

\*3 You cannot activate the repeat mode and the random mode at the same time.

## USB

### ❑ Settings for USB playback—<USB Mode>

1

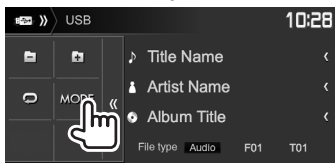
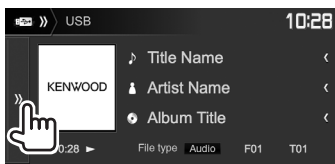

2

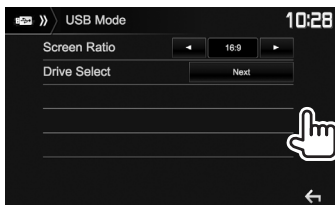

### <Screen Ratio>

Select the monitor type to watch a wide screen picture on the external monitor.



### <Drive Select>

Switches between internal memory and the memory source of the connected device (such as mobile phone). Press [Next].

### ❑ Selecting a folder/track on the list

1 Display the folder/track list during playback.



2 Select the folder (①), then the item in the selected folder (②).

- Repeat the procedure until you select the desired track.

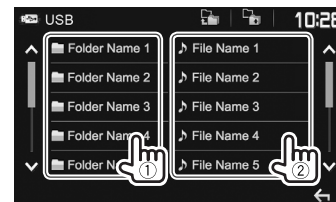

- You can change the page to display more items by pressing [ $\wedge$ ]/[ $\nabla$ ].
- Press [ $\leftarrow$ ] to return to the root folder.
- Press [ $\rightarrow$ ] to return to the upper layer.

# Android

## Preparation

### ❑ Installing KENWOOD Music Play

Install the Android™ application KENWOOD Music Play on your Android device beforehand.

- When a compatible Android device is connected, "Press [VIEW] to install KENWOOD MUSIC PLAY APP" is shown on the Android device. Follow the instructions to install the application. You can also install the latest version of the KENWOOD Music Play application on your Android device before connecting.

### About KENWOOD Music Play

- This unit supports the Android™ application KENWOOD Music Play.
- When you use KENWOOD Music Play, you can search for audio files by Genre, Artist, Album, Playlist, and Song.
- KENWOOD Music Play is available on the following web site: <[www.kenwood.com/cs/ce/](http://www.kenwood.com/cs/ce/)>

### ❑ Connecting an Android device

Connect an Android device with a cable.

- For details about connecting Android devices, see page 65.

### Compatible Android devices

- This unit supports Android OS 4.1 and above.
- Some Android devices (with OS 4.1 and above) may not fully support Android Open Accessory (AOA) 2.0.
- If the Android device supports both mass storage class device and AOA 2.0, this unit always plays back via AOA 2.0 as priority.
- For more information and the latest compatible list, see: <[www.kenwood.com/cs/ce/](http://www.kenwood.com/cs/ce/)>

### ❑ Starting playback

- 1 Start KENWOOD Music Play on your Android device.
- 2 Select "Android™" as the source.  
(Page 10)

## Playback operations

### ❑ Indications and buttons on the source control screen



### Playback information

- 1 Artwork (Shown if the song contains artwork)
- 2 Track information
  - Pressing [<] scrolls the text if not all of the text is shown.
- 3 Playing time
- 4 Playback status
- 5 Playback mode (Page 20)
- 6 Track no./Total track number

Continued on the next page...

# Android

## Operation buttons

- [>>] Displays the other operation button window.
- To hide the window, press [≪≪].
- [📊] Displays the <Equalizer> screen. (Page 47)
- [Q] Displays the audio menu. (See the right column.)
- [◀◀] [▶▶]
- Selects a track. (Press)
  - Reverse/forward search. (Hold)
- ▶||
- Starts/pauses playback.
- [X]
- Selects random playback mode.\*
- X: Randomly plays all tracks.
  - X **Album**: Randomly plays all tracks in the current album.
- [🔄]
- Selects repeat playback mode.
- 🔄 ①: Repeats the current track.
  - 🔄 **All**: Repeats all tracks.
  - 🔄: Cancels the repeat mode.
- [MODE]
- Changes the settings for Android playback on the <Android Mode> screen. (See the far right column.)

\* To cancel random mode, press the button repeatedly until the indicator disappears.

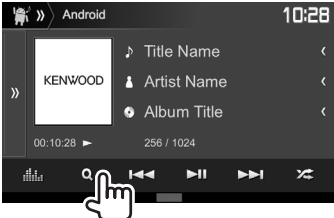

## ❑ Selecting a track from the menu

- 
- Select a category (①), then a desired item (②).

  - To list the items in alphabetical order, press [Q A-Z], then select the first character on the keypad.
  - Alphabet search is not available when the playlist is selected.
  - Select an item in each layer until you reach and select the desired file.
  - You can change the page to display more items by pressing [▲]/[▼].
  - Press [🏠] to return to the top layer.
  - Press [🏠] to return to the upper layer.

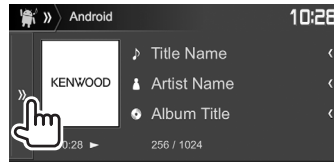
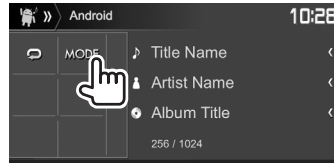

## ❑ Settings for playback on the Android device—<Android Mode>

- 
- 
- 

<Artwork>	Shows/hides artwork of the Android device.
<Android Setup>	<ul style="list-style-type: none"> <li><b>BROWSE MODE</b>: Controls from the unit (using the KENWOOD Music Play application).</li> <li><b>HAND MODE</b>: Controls other media player applications from the Android device (without using the KENWOOD Music Play application). <ul style="list-style-type: none"> <li>You can play/pause or skip files from the unit.</li> </ul> </li> </ul>



# iPod/iPhone

## Preparation

### ❑ Connecting iPod/iPhone

- For details about connecting iPod/iPhone, see page 65.
- For playable iPod/iPhone types, see page 70.

Connect your iPod/iPhone according to your purpose or the type of iPod/iPhone.

### Wired connection

- **To listen to music:** Use USB Audio cable for iPod/iPhone.
  - For Lightning connector models: KCA-iP103 (optional accessory)
  - For 30-pin connector models: KCA-iP102 (optional accessory)
- **To watch video and listen to music (only for 30-pin connector models):** Use USB Audio and Video cable for iPod/iPhone—KCA-iP202 (optional accessory).
  - For Lightning connector models: You cannot watch video with KCA-iP202.

### Bluetooth connection

- Pair the iPod/iPhone through Bluetooth. (Page 38)
- You cannot watch video with a Bluetooth connection.

### ❑ Selecting iPod/iPhone device to play and the connection method

- 1 Display the **<System>** setting screen. On the Home screen:

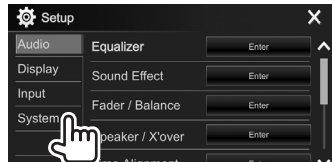
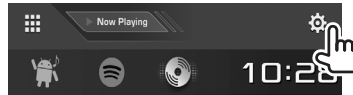

- 2

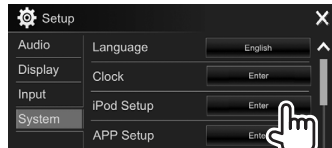

- 3 Select the connection method (①), then confirm the selection (**[OK]** or **[Next]**) (②).

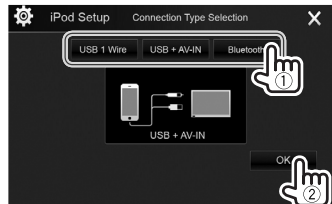

**[USB 1 Wire]** Select this when the iPod/iPhone is connected using KCA-iP102 or KCA-iP103 (optional accessory).

**[USB + AV-IN]** Select this when the iPod/iPhone is connected using KCA-iP202 (optional accessory).

**[Bluetooth]** Select this when the iPod/iPhone is connected via Bluetooth. (Go to step 4.)

- 4 When selecting **[Bluetooth]** as the connection method: Select the device (①), then press **[OK]** to connect (②).

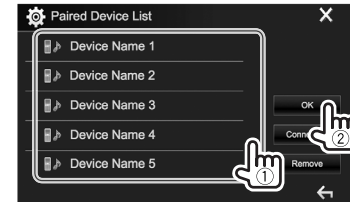

- If the device is already connected, skip step ①.

## iPod/iPhone

### ❑ Displaying/hiding artwork of iPod/iPhone

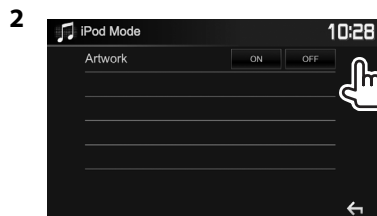
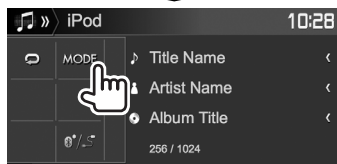
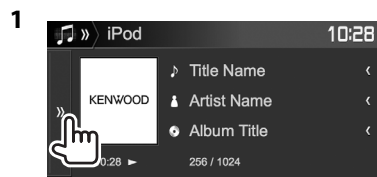

**[ON]** Shows artwork of iPod/iPhone.

**[OFF]** Hides artwork of iPod/iPhone.

### Playback operations

When the operation buttons are not displayed on the screen, touch the area shown on the illustration.

- To change settings for video playback, see page 50.

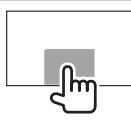

### ❑ Indications and buttons on the source control screen

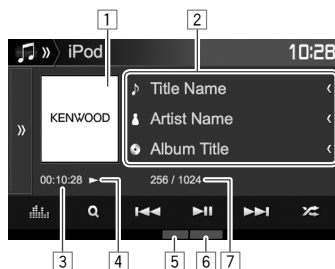

#### Playback information

- 1 Artwork (Shown if the song contains artwork)
- 2 Song/video information
  - Pressing [**<**] scrolls the text if not all of the text is shown.
- 3 Playing time
- 4 Playback status
- 5 Playback mode (See the right column.)
- 6 File type
- 7 Track no./Total track number

#### Operation buttons

- [>>]
- Displays the other operation button window.
- To hide the window, press [≪≪].
- [📊]
- Displays the **<Equalizer>** screen. (Page 47)
- [Q]
- Displays the audio/video file menu. (Page 23)
- [⏪] [⏩]
- Selects a track. (Press)
  - Reverse/forward search. (Hold)
- ▶ ||
- Starts/pauses playback.
- [🔀]
- Selects random playback mode.\*
- 🔄: Functions the same as Shuffle Songs.
  - 🔄 Album: Functions the same as Shuffle Albums.
- [🔁]
- Selects repeat playback mode.
- 🔁 ①: Functions the same as Repeat One.
  - 🔁 All: Functions the same as Repeat All.
  - 🔁: Cancels the repeat mode.
- [MODE]
- Changes the settings for iPod/iPhone playback on the **<iPod Mode>** screen. (See the far left column.)
- [🔇/🔊]
- Switches the device on the **<iPod Setup>** screen. (Page 21)

\* To cancel random mode, press the button repeatedly until the indicator disappears.

## iPod/iPhone

### ❑ Selecting an audio/video file from the menu

1

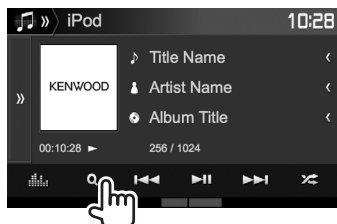

2 Select the menu (⏮): audio or (⏮): video (①), a category (②), then a desired item (③).

- To list the items in alphabetical order, press [Q A-Z], then select the first character on the keypad.
  - Alphabet search is not available when the playlist is selected.
- Select an item in each layer until you reach and select the desired file.
- You can change the page to display more items by pressing [⏮]/[⏭].
- Press [⏮] to return to the top layer.
- Press [⏭] to return to the upper layer.

### Audio menu:



### Video menu:

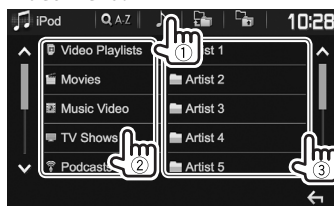

- Available categories differ depending on the type of your iPod/iPhone.

# APPs

You can use an App of the connected iPod touch/iPhone/Android on this unit.

- For Apps you can use on this unit, visit <<http://www.kenwood.com/cs/ce/>>.

## Preparation

- 1 Connect the iPod touch/iPhone/Android.
  - **For Android:** Connect the Android device via Bluetooth. (Page 38)
  - **For iPod touch/iPhone:** Connect iPod touch/iPhone with a cable. (Page 65)
    - Be sure to select the appropriate connection method of iPod touch/iPhone on <**APP Setup**>. (Page 46)
    - You cannot watch video when connecting a Lightning connector model.
- 2 Select the iPod touch/iPhone/Android device to use on the <**APP Setup**> screen. (Page 46)

When connecting the device for the first time, the setup screen (for connection, etc.) appears. Follow the procedure on the setup screen to configure the settings.

## Using an App

When the operation buttons are not displayed on the screen, touch the screen to show them.

- To change settings for video playback, see page 50.

### Playback operations

- 1 Start the App on your iPod touch/iPhone/Android.
- 2 Select “**APPs**” as the source. (Page 10)

### Operation buttons on the source control screen

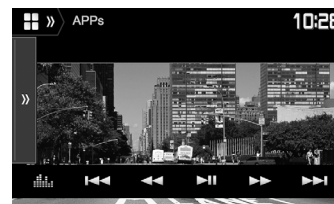

- [>>] Displays the other operation button window.
  - To hide the window, press [⟨⟨].
- [|||||] Displays the <**Equalizer**> screen. (Page 47)
- [|<<<|>>>|]\* Selects an audio/video file.
- [<<<|>>>]\* Reverse/forward search.
- [▶||]\* Starts/pauses playback.
- [▶]\* Starts playback.
- [||]\* Pauses playback.
- [📱 / 📺]\* Switches the device on the <**APP Setup**> screen. (Page 46)

- You can operate some functions of the App on the touch panel.
- You can control playback of the following:
  - Audio playback via iPod touch/iPhone/Android devices
  - Video playback via iPod touch/iPhone

\* Applicable for iPod touch/iPhone only.

# Spotify (Only for DDX4017DAB/DDX4017BT/DDX317BT)

With Spotify, your music is everywhere. Working out, partying or relaxing, the right music is always at your fingertips. There are millions of songs on Spotify—from old favorites to the latest hits. Just choose the music you love, or let Spotify surprise you.

You can stream Spotify from connected iPod touch/iPhone or Android devices.

- Install the latest version of the Spotify application on your iPod touch/iPhone/Android and create an account.

## Preparation

### 1 Connect the device.

- **For Android:** Connect the Android device via Bluetooth. (Page 38)
- **For iPod touch/iPhone:** Connect iPod touch/iPhone with a cable (Page 65) or via Bluetooth (Page 38).
  - Be sure to select the appropriate connection method of iPod touch/iPhone on **<iPod Setup>**. (Page 21)

### 2 Select the device to use on the **<APP Setup>** screen. (Page 46)

### 3 Select **"Spotify"** as the source. (Page 10) The Spotify application is started.

- If the device selection screen is displayed, select the device to use. (Page 46)

## Playback operations

You can operate Spotify using the remote controller\*1. Only playing, pausing, and skipping are available.

### ▣ Indications and buttons on the source control screen



#### Playback information

- 1 Picture data
- 2 Track information
  - Pressing [**<**] scrolls the text if not all of the text is shown.
- 3 Playing time
- 4 Playback status
- 5 Progress bar

#### Operation buttons

- [🖼️]/ [📄] Changes the displayed information each time this button is pressed (🖼️: artist/📄: album).
- [>>] Displays the other operation button window.
  - To hide the window, press [**<<**].

- [📊] Displays the **<Equalizer>** screen. (Page 47)
- [☰] Displays the Spotify menu screen. (Page 26)
- [⏪] [⏩] Selects a track.
- [▶️]\*2 Starts playback.
- [⏸️]\*2 Pauses playback.
- [+] Saves the current track/artist to **<Your Music>**.
- [👍]\*3 Thumbs down to the current track and skips to the next track.
- [👍]\*3 Registers the current track as a favorite.
- [🔀] Activates/deactivates the shuffle playback mode.
- [🔄] Repeats all tracks/cancels the repeat playback.
- [🔁]\*4 Repeats the current track/cancels the repeat playback.
- [📶] Creates a new station. (Page 26)
- [🔌 / 🔌] Switches the device on the **<APP Setup>** screen. (Page 46)

\*1 Purchase KNA-RCDV331 separately.

\*2 During playback, [⏸️] is displayed, and when playback is paused, [▶️] is displayed.

\*3 Not available for tracks in a playlist.

\*4 Appears only for premium account users.

# Spotify

## ❑ Creating your station (Start Radio)

1

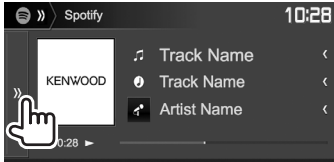

- 2 Enter a track/artist/playlist in the search box, then select the desired track. The playback of your station starts with the selected track.

- You can personalize your station using thumb up (👍) or thumb down (👎).
- You cannot thumb up or down while playing tracks in a playlist.

## ❑ Selecting a track

- 1 Display the Spotify menu screen.



- 2 Select the list type (<Your Music>/<Browse>/<Radio>/<Play Queue>), then select a desired item.
- The list types displayed differ depending on the information sent from Spotify.

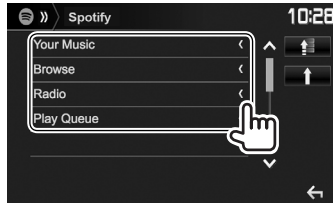

- Press [⏪] to return to the top layer.
- Press [⏩] to return to the upper layer.

## Requirements for Spotify

### iPhone or iPod touch

- Install the latest version of the Spotify application on your iPhone or iPod touch. (Search for “Spotify” in the Apple iTunes App Store to find and install the most recent version.)
- Connect iPod touch/iPhone to this unit with KCA-iP202, KCA-iP102 or KCA-iP103 (optional accessory).
- Bluetooth must be built in and the following profiles must be supported.
  - SPP (Serial Port Profile)
  - A2DP (Advanced Audio Distribution Profile)

### Android™

- Visit Google Play™ and search for “Spotify” to install.
- Bluetooth must be built in and the following profiles must be supported.
  - SPP (Serial Port Profile)
  - A2DP (Advanced Audio Distribution Profile)

### NOTE

- Ensure you are logged in to your smartphone application. If you do not have a Spotify account, you can create one for free from your smartphone or at [www.spotify.com](http://www.spotify.com).
- Because Spotify is a third-party service, the specifications are subject to change without prior notice. Accordingly, compatibility may be impaired or some or all of the services may become unavailable.
- Some functions of Spotify cannot be operated from this unit.
- For issues using the application, contact Spotify at [www.spotify.com](http://www.spotify.com).
- Establish an Internet connection using LTE, 3G, EDGE, or WiFi.

# RADIO

## Listening to the radio

### Indications and buttons on the source control screen

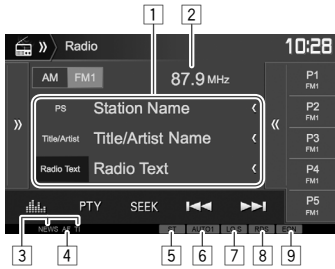

### Radio reception information

- Text information
  - Pressing [**<**] scrolls the text if not all of the text is shown.
  - Pressing [**Radio Text**] switches the information between Radio Text, Radio Text Plus, and PTY code.
- The station frequency currently tuned in
- Standby reception indicators (NEWS/TI)
- AF indicator
- ST/MONO indicator
  - The ST indicator lights up when receiving an FM stereo broadcast with sufficient signal strength.
- Seek mode indicator
- LO.S indicator (See the far right column.)
- RDS indicator: Lights up when receiving a Radio Data System station.
- EON indicator: Lights up when a Radio Data System station is sending EON signals.

### Operation buttons

- [**>>>**] Displays the other operation button window.
- To hide the window, press [**<<<**].
- [**AM**] Selects the AM band.
- [**FM**] Selects the FM band.
- [**<<<**] Displays the preset station window. (Page 28)
- To hide the window, press [**>>>**].
- [**P1**] – [**P5**] Selects a stored station. (Press)
- Stores the current station. (Hold)
- [**Equalizer**] Displays the **<Equalizer>** screen. (Page 47)
- [**PTY**]\* Enters PTY search mode. (Page 28)
- [**SEEK**] Changes the seek mode.
- AUTO1**: Auto Search
  - AUTO2**: Tunes in stations in the memory one after another.
  - MANU**: Manual Search
- [**<<<**] [**>>>**] Searches for a station.
- The search method differs according to the selected seek mode. (See above.)
- [**AME** ↓]\* Presets stations automatically. (Hold) (Page 28)
- [**MONO**]\* Activates/deactivates monaural mode for better FM reception. (Stereo effect will be lost.)
- The MONO indicator lights up while monaural mode is activated.
- [**TI**]\* Activates/deactivates TI standby reception mode. (Page 29)

[**MODE**]\* Changes the settings for radio reception on the **<Radio Mode>** screen. (See below and page 29)

\* Appears only when FM is selected as the source.

### Tuning in FM stations only with strong signals—Local Seek

- Display the **<Radio Mode>** screen.

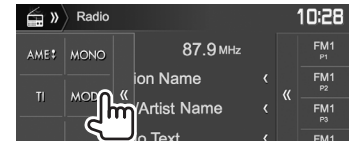
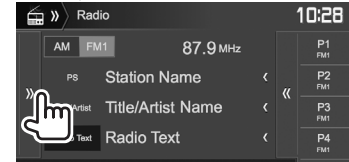

- 
- 

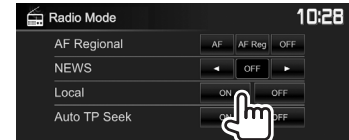

The unit tunes in only to stations with sufficient signal strength. The LO.S indicator lights up.

**To deactivate Local Seek:** Press [**OFF**].

# RADIO

## Presetting stations

### ❑ Storing stations in the memory

You can preset 5 stations for each band.

### Automatic presetting—AME (Auto Memory) (for FM only)

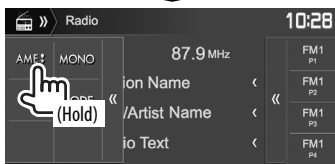
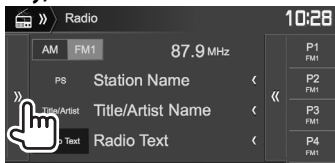

The local stations with the strongest signals are found and stored automatically.

### Manual presetting

- 1 Tune in to a station you want to preset. (Page 27)
- 2 Select a preset number.

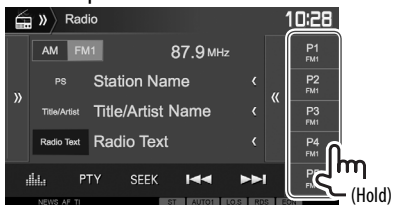

The station selected in step 1 is stored.

### ❑ Selecting a preset station

- 1 Select the band (①), then display the preset station window (②).

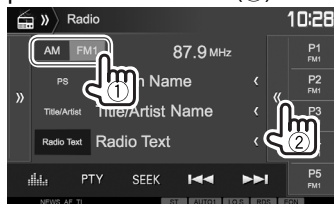

- You can also select a preset station by pressing [P1] – [P5].

- 2 Select a preset station.

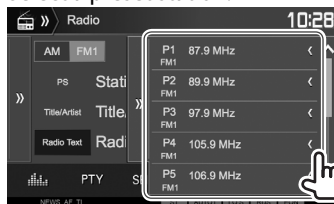

- Pressing [<] scrolls the text if not all of the text is shown.
- To hide the window list, press [>>>].

## FM Radio Data System features

### ❑ Searching for FM Radio Data System programs—PTY Search

You can search for your favorite programs being broadcast by selecting the PTY code.

- 1



- 2 Select a PTY code.

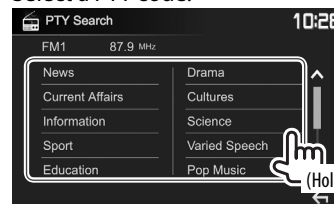

- You can change the page to display more items by pressing [^]/[v]. PTY Search starts.

If there is a station broadcasting a program of the same PTY code as you have selected, that station is tuned in.

- Only English/Spanish/French/German/Dutch/Portuguese are available for the text language here. If another language has been selected in <Language> (Page 58), the text language is set to English.



# RADIO

## ❑ Activating/deactivating TI/News Standby Reception

### TI Standby Reception

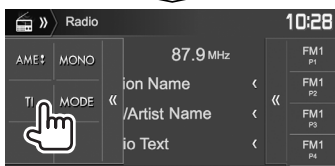
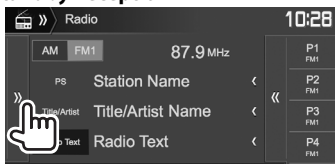

The unit is in standby to switch to Traffic Information (TI) if available. (The TI indicator lights up in white.)

- If the TI indicator is lit in orange, tune into another station providing Radio Data System signals.

**To deactivate TI Standby Reception:** Press [TI]. (The TI indicator turns off.)

- The volume adjustment for Traffic Information is automatically memorized. The next time the unit switches to Traffic Information, the volume is set to the previous level.
- For DDX4017DAB: The TI Standby Reception can also be activated or deactivated from “DAB” source control screen. (Page 32)

### News Standby Reception

1 Display the <Radio Mode> screen. (Page 27)

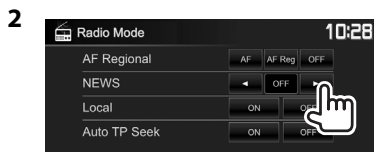

<00min> – Activate News Standby Reception (the NEWS indicator lights up).

<90min> Select the period of time to disable interruption.

<OFF> Deactivate the function.

- The volume adjustment while receiving News is automatically memorized. The next time the unit switches to News, the volume is set to the previous level.

## ❑ Tracing the same program—Network-Tracking Reception

When driving in an area where FM reception is not sufficient enough, this unit automatically tunes in to another FM Radio Data System station of the same network, possibly broadcasting the same program with stronger signals.

- When shipped from the factory, Network-Tracking Reception is activated.

### To change the Network-Tracking Reception setting

1 Display the <Radio Mode> screen. (Page 27)

2



[AF] Switch to another station. The program may differ from the one currently received (the AF indicator lights up).

[AF Reg] Switch to another station broadcasting the same program (the AF indicator lights up).

[OFF] Deactivate the function.

- The RDS indicator lights up when the Network-Tracking Reception is activated and an FM Radio Data System station is found.

## ❑ Automatic TI station seek—Auto TP Seek

When traffic information station reception is poor, the unit automatically searches for another station that can be received better.

### To activate Auto TP Seek

1 Display the <Radio Mode> screen. (Page 27)

2

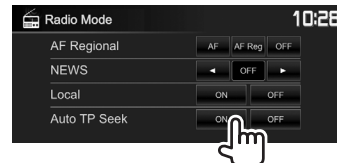

**To deactivate Auto TP Seek:** Press [OFF].

# DIGITAL RADIO (DAB) (Only for DDX4017DAB)

## About DAB (Digital Audio Broadcasting)

### What is DAB system?

DAB (Digital Audio Broadcasting) is one of the digital radio broadcasting systems available today. It can deliver digital quality sound without any annoying interference or signal distortion. Furthermore, it can carry text and data.

In contrast to FM broadcast, where each program is transmitted on its own frequency, DAB combines several programs (called "services") to form one "ensemble."

The "Primary component" (main radio station) is sometimes accompanied by a "secondary component" which can contain extra programs or other information.

## Listening to Digital Radio

### Indications and buttons on the source control screen

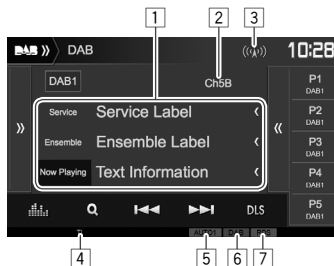

### Tuner reception information

- 1 Text information
  - Pressing [**<**] scrolls the text if not all of the text is shown.
  - Pressing [**Now Playing**] switches the information. Each time you press the button, the information and the button switch between [**Next Program**], [**Title**], [**Artists**], [**PTY**], and [**Audio Quality**].
- 2 Channel no.
- 3 Signal strength
- 4 TI indicator
- 5 Seek mode indicator
- 6 DAB reception indicator
  - The DAB indicator lights up when receiving a DAB broadcast.
  - The MC indicator lights up when receiving a DAB multi component.
- 7 RDS indicator: Lights up when receiving a Radio Data System service.

### Operation buttons

- [**>>**]
  - [**<<**]
  - [**P1**] – [**P5**]
  - [**||||**]
  - [**Q**]
  - [**|-<< |>>|**]
  - [**DLS**]
  - [**PTY**]
  - [**SEEK**]
  - [**TI**]
  - [**MODE**]
- Displays the other operation button window.
- Displays the preset services window. (Page 31)
- To hide the window, press [**<<**].
  - To hide the window, press [**>>**].
- Selects a stored service. (Press)
- Stores the current service. (Hold)
- Displays the **<Equalizer>** screen. (Page 47)
- Displays the **<Service List>** screen. (Page 31)
- Searches for a service.
- The search method differs according to the selected seek mode. (See below.)
- Displays Dynamic Label Segment Screen (text messages the service sends)
- Enters PTY search mode. (Page 32)
- Changes the seek mode.
- **AUTO1**: Auto Search
  - **AUTO2**: Tunes in the services in the memory one after another.
  - **MANU**: Manual Search
- Activates/deactivates TI standby reception mode. (Page 32)
- Changes the settings for DAB reception on the **<DAB Mode>** screen. (Page 33)

## DIGITAL RADIO (DAB)

### ❑ Selecting a service from the list

- 1 Display the <Service List> screen.



- 2 Select a service from the list.

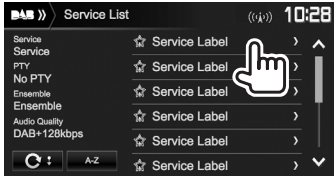

- You can change the page to display more items by pressing [**▲**]/[**▼**].
- Press [**A-Z**] to search for the initial letter. Pressing [**A-Z**] displays the <A-Z Search> screen. Select the initial to start the search.
  - If you want to search with non-alphabetical characters, press [**#**].
- Press and hold [**C ↕**] to update the <Service List>.

### Presetting services

#### ❑ Storing services in the memory

You can preset 5 services for each band.

- 1 Select a service you want to preset. (Page 30)
- 2 Select a preset number.



The service selected in step 1 is stored.

### ❑ Selecting a preset service

- 1 Display the preset services window.

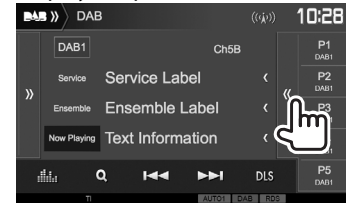

- You can also select a preset service by pressing [**P1**] – [**P5**].

- 2 Select a preset service.

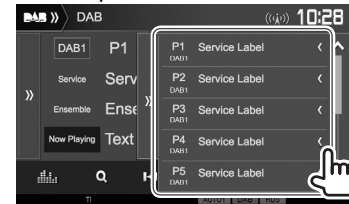

- Pressing [**<**] scrolls the text if not all of the text is shown.
- To hide the window, press [**>>>**].

# DIGITAL RADIO (DAB)

## Radio Data System features

### □ Searching for Radio Data System programs—PTY Search

You can search for your favorite programs being broadcast by selecting the PTY code.

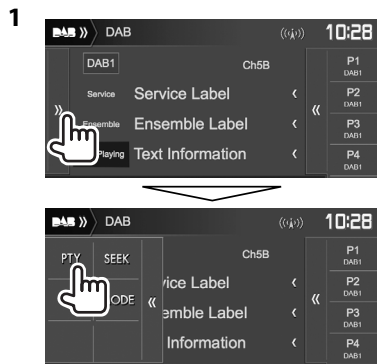

2 Select a PTY code.

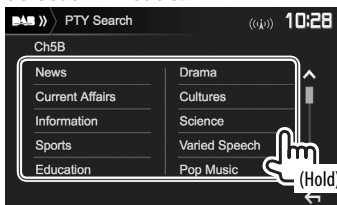

- You can change the page to display more items by pressing [ ^ ]/[ v ]. PTY Search starts. If there is a service broadcasting a program of the same PTY code as you have selected, that service is tuned in.
- Only English/Spanish/French/German/Dutch/Portuguese are available for the text language here. If another language has been selected in **<Language>** (Page 58), the text language is set to English.

### □ Activating/deactivating TI Standby Reception

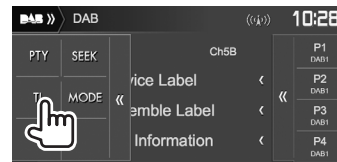
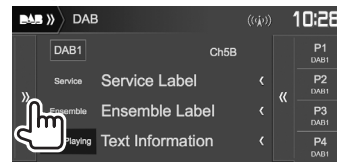

- The unit is in standby to switch to Traffic Information (TI) if available. (The TI indicator lights up in white.)
- If the TI indicator is lit in orange, tune into another service providing Radio Data System signals.

**To deactivate TI Standby Reception:** Press [TI]. (The TI indicator goes off.)

- The volume adjustment for Traffic Information is automatically memorized. The next time the unit switches to Traffic Information, the volume is set to the previous level.
- The TI Standby Reception can also be activated or deactivated from **"Radio"** source control screen. (Page 29)

## DIGITAL RADIO (DAB)

### Settings for Digital Audio Radio

You can set the Digital Radio related items.

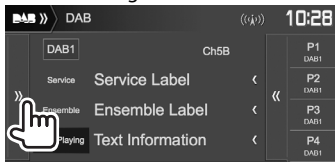

#### □ Setting items

<b>&lt;Priority&gt;</b>	<ul style="list-style-type: none"> <li>• <b>ON</b> (Initial): If the same service is provided by Digital Radio during Radio Data System reception, the unit automatically switches to Digital Radio. If the same service is provided by Radio Data System when reception of the service being provided by Digital Radio becomes poor, the unit automatically switches to Radio Data System.</li> <li>• <b>OFF</b>: Deactivates.</li> </ul>
-------------------------	--

<b>&lt;PTY Watch&gt;</b>	<p>If the service of the set program type begins with the ensemble being received, the unit switches from any source to Digital Radio for service reception. Select the type of program using [◀] and [▶].</p>
<b>&lt;Announcement Select&gt;</b>	<p>If the service of the announcement item you activated begins with the ensemble being received, this unit switches from any source to the announcement received.*1</p> <p>Set [ON] for the announcement items you need.</p> <ul style="list-style-type: none"> <li>• <b>News flash/Transport flash/Warning/Service/ Area weather flash/ Event announcement/ Special event/Programme information/Sport report/ Financial report</b> <ul style="list-style-type: none"> <li>– To deactivate all announcements, select [<b>All OFF</b>].</li> <li>– Only English/Spanish/French/German/Dutch/Portuguese/Italian/Turkish are available for the text language here. If another language has been selected in <b>&lt;Language&gt;</b> (Page 58), the text language is set to English.</li> </ul> </li> </ul>

<b>&lt;Seamless Blend&gt;</b>	<ul style="list-style-type: none"> <li>• <b>ON</b> (Initial): Prevents audio break when switching from Digital Radio to Analog Radio.</li> <li>• <b>OFF</b>: Cancels.</li> </ul>
<b>&lt;Antenna Power&gt;</b>	<ul style="list-style-type: none"> <li>• <b>ON</b> (Initial): Supplies power to the DAB aerial.</li> <li>• <b>OFF</b>: Cancels</li> </ul>
<b>&lt;L-Band Tuning&gt;#2</b>	<p>If the reception of the service is poor, activate the L-Band reception.</p> <ul style="list-style-type: none"> <li>• <b>ON</b>: Receives the L-Band width during Digital Audio reception.</li> <li>• <b>OFF</b> (Initial): Cancels</li> </ul>
<b>&lt;Related Service&gt;</b>	<ul style="list-style-type: none"> <li>• <b>ON</b>: When the current selected DAB service network is not available and found the related service, the unit offers to switch to the related service.</li> <li>• <b>OFF</b> (Initial): Cancels.</li> </ul>

\*1 The volume adjustment while receiving Announcement is automatically memorized. The next time the unit switches to Announcement, the volume is set to the previous level.

\*2 When the setting is changed, the preset services are initialized.

# OTHER EXTERNAL COMPONENTS

## Using the rear view camera

- To connect a rear view camera, see page 66.
- To use a rear view camera, a REVERSE lead connection is required. (Page 64)

### ❑ Settings for the rear view camera

- 1 Display the <Input> settings screen. On the Home screen:

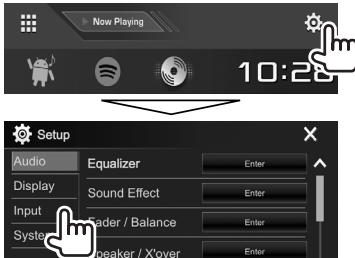

- 2 Display the <Rear Camera> screen.

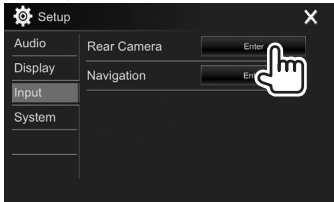

3

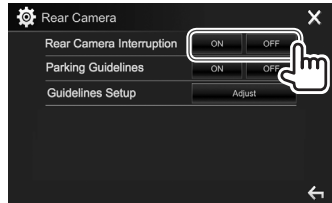

- [ON]** Displays the picture from the rear view camera when you shift the gear to the reverse (R) position.
- [OFF]** Select this when no camera is connected.

- ❑ **Displaying the rear view camera screen**  
**To display the picture from the rear view camera**  
The rear view screen is displayed when you shift the gear to the reverse (R) position.



- To remove the caution message, touch the screen.

### **To display the picture from the rear view camera manually**

On the pop-up short-cut menu (Page 11):  
Display the pop-up short-cut menu by pressing MENU on the monitor panel, then select [**Camera**].



## OTHER EXTERNAL COMPONENTS

### To exit the camera screen

On the camera screen:

Touch the area shown below.

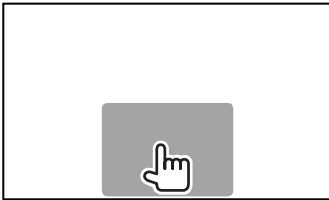

### To adjust the picture

While the camera screen is displayed...



- The video control menu is displayed. (Page 50)  
To close the picture adjustment menu, touch the same area again.

### Using the parking guidelines on the rear view screen

You can display parking guidelines to enable easier parking when you shift the gear to the reverse (R) position.

#### Displaying the parking guidelines

- 1 Display the <Input> settings screen.

On the Home screen:

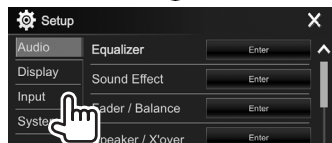
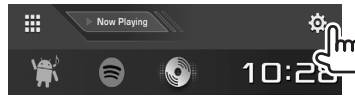

- 2 Display the <Rear Camera> screen.

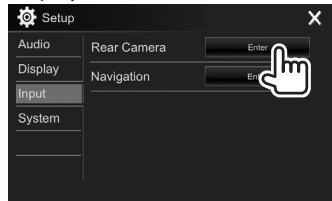

3

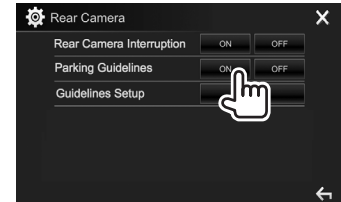

**To deactivate:** Select [OFF] for <Parking Guidelines>.

- You can also display the parking guidelines by touching the area shown below. To close the parking guidelines, touch the same area again.



## OTHER EXTERNAL COMPONENTS

### Adjusting the parking guidelines

Adjust the parking guidelines according to the size of the car, parking space and so on.

- Install the rear view camera in the appropriate position according to the instructions supplied with the rear view camera.
- When adjusting the parking guidelines, make sure to use the parking brake to prevent the car from moving.

1 Display the <Rear Camera> screen.  
(Page 35)

2 Display the parking guidelines adjustment screen.

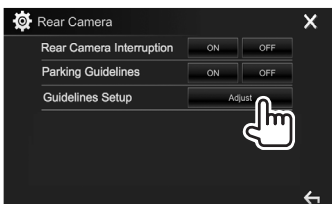

3 Adjust the parking guidelines by selecting the ⚙️ mark (①), then adjusting the position of the selected ⚙️ mark (②).

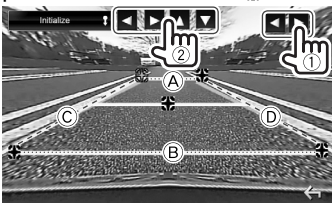

Make sure that ① and ② are horizontally parallel, and that ③ and ④ are the same length.

- Press and hold [Initialize ↓] for 2 seconds to set all the ⚙️ marks to the initial default position.

### Using external audio/video players—AV-IN

When the operation buttons are not displayed on the screen, touch the area shown on the illustration.

- To change settings for video playback, see page 50.



### Starting playback

#### Preparation:

“AV-IN” cannot be selected when <iPod Setup> is set to [USB+AV-IN]. Be sure to select [USB 1 Wire] for <iPod Setup> beforehand. (Page 21)

- 1 Connect an external component to the iPod/AV-IN input terminal. (Page 66)
- 2 Select “AV-IN” as the source. (Page 10)
- 3 Turn on the connected component and start playing the source.

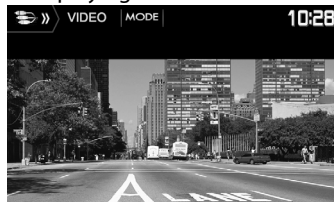

### Changing the AV-IN name

You can change the AV-IN name displayed on the “AV-IN” source control screen.

1 Display the <VIDEO Mode> screen.



2 Select an AV-IN name.

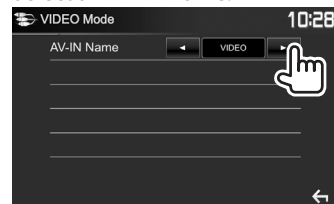

- This setting does not affect the source name displayed on the Home screen.



## OTHER EXTERNAL COMPONENTS

### Using the external navigation unit (Only for DDX4017DAB/DDX4017BT)

You can connect a navigation unit (KNA-610 or KNA-G620T: optional accessory) to the NAV input terminal so that you can view the navigation screen. (Page 66)

- The navigation guidance comes out of the front speakers even when you are listening to an audio source.

#### ❑ Viewing the navigation screen

On the Home screen:

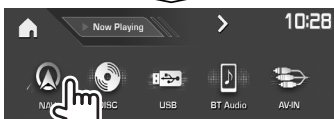
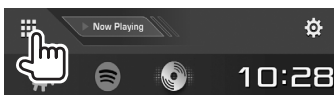

- You can also display the navigation screen by pressing AV/DISP OFF on the monitor panel while listening to another source.
- While the navigation screen is displayed, the touch panel operations are available only for navigation.
- The aspect ratio of the navigation screen is fixed to **<FULL>** regardless of the **<Aspect>** setting (Page 50).

### When receiving a call during navigation guidance

The screen is switched automatically. To return to the navigation screen, press [ ].



### To exit the navigation screen

On the pop-up short-cut menu (Page 11):  
Display the pop-up short-cut menu by pressing MENU on the monitor panel, then select [**Current Source**].



On the monitor panel:  
Press AV/DISP OFF on the monitor panel.

#### ❑ Settings for the navigation unit

##### 1 Display the <Input> setting screen.

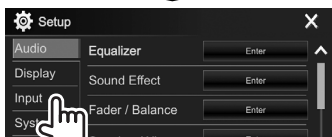
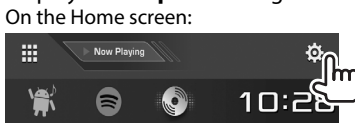

##### 2 Display the <Navigation> screen.

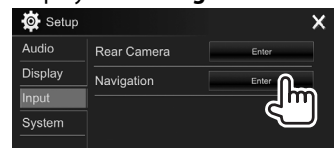

##### 3

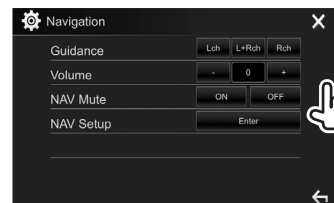

- <Guidance>** Select which front speakers are used for the navigation guidance.
- <Volume>** Adjust the volume of the navigation guidance. (0 to 35)
- <NAV Mute>** Select [**ON**] to attenuate the sound coming out of speakers other than the front speakers during navigation guidance.
- To cancel the attenuation, select [**OFF**].
- <NAV Setup>** Press [**Enter**] to display the setup screen for the navigation unit. See the instruction manual supplied for the navigation unit.

# BLUETOOTH

## Information for using Bluetooth® devices



Bluetooth is a short-range wireless radio communication technology for mobile devices such as mobile phones, portable PCs, and other devices. Bluetooth devices can be connected without cables and communicate with each other.

### Notes

- While driving, do not perform complicated operations such as dialing numbers, using the phone book, etc. When you perform these operations, stop your car in a safe place.
- Some Bluetooth devices may not connect to this unit depending on the Bluetooth version of the device.
- This unit may not work for some Bluetooth devices.
- Connecting conditions may vary depending on your environment.
- For some Bluetooth devices, the device is disconnected when the unit is turned off.

### About mobile phones compatible with Phone Book Access Profile (PBAP)

If your mobile phone supports PBAP, you can display the following items on the touch panel screen when the mobile phone is connected.

- Phone book
- Dialed calls, received calls, and missed calls (up to 10 entries in total)

## Connecting Bluetooth devices

### ❑ Registering a new Bluetooth device

When you connect a Bluetooth device to the unit for the first time, pair the unit and the device. Pairing allows Bluetooth devices to communicate with each other.

- The pairing method differs depending on the Bluetooth version of the device.
  - For devices with Bluetooth 2.1: You can pair the device and the unit using SSP (Secure Simple Pairing) which only requires confirmation.
  - For devices with Bluetooth 2.0: You need to enter a PIN code both on the device and unit for pairing.
- Once the connection is established, it is registered in the unit even if you reset the unit. Up to five devices can be registered in total.
- Two devices for Bluetooth phone and one for Bluetooth audio can be connected at a time. However, when “**BT Audio**” is selected as the source, you can connect to five Bluetooth audio devices and switch between these five devices.
- To use the Bluetooth function, you need to turn on the Bluetooth function of the device.
- To use the registered device, you need to connect the device to the unit. (Page 40)

### Auto pairing

When <Auto Pairing> is set to [ON], iOS devices (such as iPhone) are automatically paired when connected via USB. (Page 45)

### Pairing a Bluetooth device using SSP (for Bluetooth 2.1)

When the Bluetooth device is compatible with Bluetooth 2.1, a pairing request is sent from an available device.

- 1 Search for the unit (“**DDX\*\*\*\***”) from your Bluetooth device.
- 2 Confirm the request both on the device and the unit.

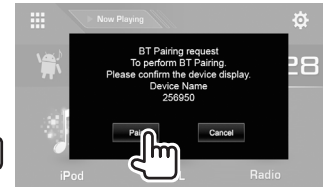

- Press [**Cancel**] to reject the request.

# BLUETOOTH

## Pairing a Bluetooth device using a PIN code (for Bluetooth 2.0)

- 1 Display the <Bluetooth Setup> screen.  
On the Home screen:

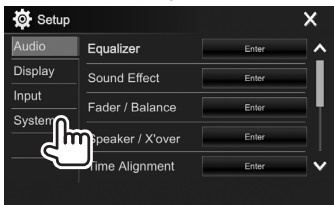
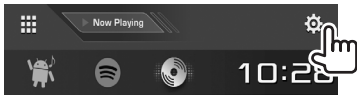

- You can also display the <Bluetooth Setup> screen by pressing [ ] on the phone control screen. (Page 42)

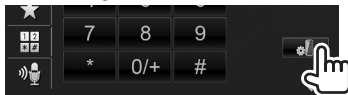

- 2 Change the PIN code.
  - If you wish to skip changing the PIN code, go to step 3.
  - The PIN code is initially set to “0000”.
  - The maximum number of digits in the PIN code is 15.

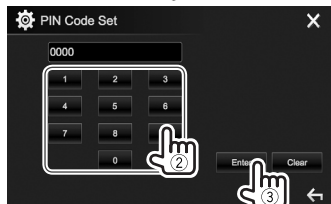

- Press [Clear] to delete the last entry.
  - Press and hold [Clear] to delete the PIN code.
- 3 Search for the unit (“DDX\*\*\*\*”) from your Bluetooth device.

- 4 Select the unit (“DDX\*\*\*\*”) on your Bluetooth device.
  - If a PIN code is required, enter “0000” (initial).

When pairing is complete, the device is listed on the <Paired Device List>.

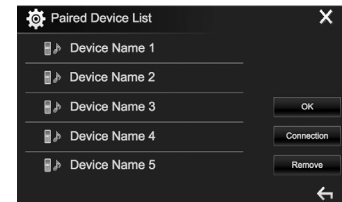

- To use the paired device, connect the device on the <Paired Device List> screen. (Page 40)

## BLUETOOTH

### ❑ Connecting/disconnecting a registered Bluetooth device

Two devices can be connected simultaneously.

1 Display the <Bluetooth Setup> screen.  
(Page 39)

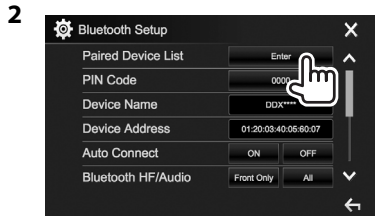

3 Select the device you want to connect (①), then press [Connection] (②).

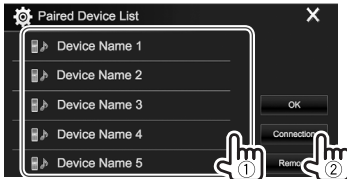

4 Select [ON] (to connect) or [OFF] (to disconnect) for the target (①), then display the <Paired Device List> screen (②).

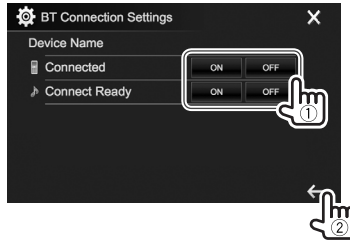

📱: Mobile phone

🎧: Audio device

- The status is shown as follows:
  - “Connecting”: Connection is in progress.
  - “Connected”: A connection has been established.
  - “Connect Ready”: A connection can be established.
  - “Disconnecting”: Disconnection is in progress.
  - “Disconnected”: No connection is established.

5 Connect the selected device.

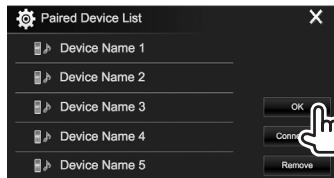

- When a Bluetooth mobile phone is connected, the signal strength and battery level are displayed when the information is acquired from the device.

### ❑ Deleting a registered Bluetooth device

1 Display the <Bluetooth Setup> screen.  
(Page 39)

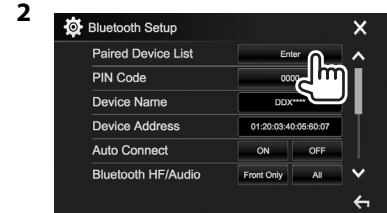

3 Select a device to delete (①), then press [Remove] (②).

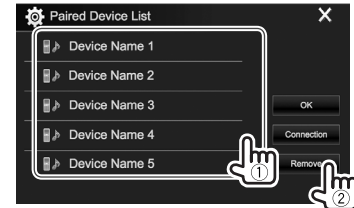

A confirmation message appears. Press [Yes].

## BLUETOOTH

### Using a Bluetooth mobile phone

#### ❑ Receiving a call

When a call comes in...

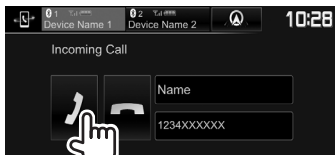

- Call information is displayed if acquired.
- Phone operation is not available while the picture from the rear view camera is displayed. (Page 34)

#### To reject a call

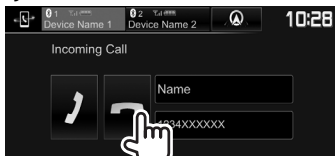

When **<Auto Response>** is set to **[ON]** (Page 45)  
The unit answers incoming calls automatically.

#### When receiving a call during navigation guidance (only for DDX4017DAB/DDX4017BT)

The screen is switched automatically. To return to the navigation screen, press [  ].

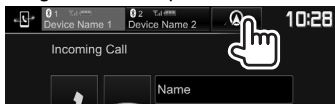

#### ❑ Ending a call

While talking...



#### ❑ Adjusting the volume of calls/earpiece/microphone

While talking...







- You can adjust the volume level between -10 to 10 (initial: -4).
- Use the monitor panel to adjust the call/earpiece volume. (Page 7)

#### ❑ Switching between handsfree mode and phone mode

While talking...



Each time you press the button, the talking method is switched (  : handsfree mode /   : phone mode).

#### ❑ Adjusting the noise reduction/echo cancel level

While talking...



- To adjust the noise reduction volume (between -5 to 5, initial: 0) : Adjust **<NR LEVEL>**.
- To adjust the echo volume (between -5 to 5, initial: 0) : Adjust **<EC LEVEL>**.

## BLUETOOTH

### ❑ Sending text during a call

You can send text during a call using the DTMF (Dual Tone Multi Frequency) function.

While talking...

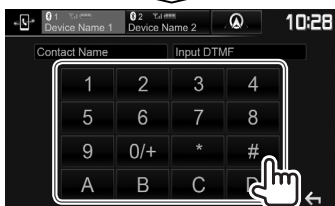
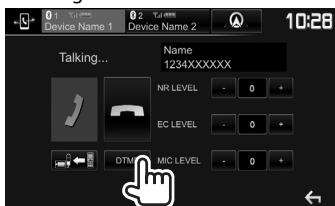

### ❑ Switching between two connected devices

You can change the device to use in the following situations:

- When 2 devices are connected
- While in phone control screen



- The active device is highlighted.

### ❑ Making a call

- 1 Display the phone control screen. On the Home screen:

- Press [ ] to change the page.

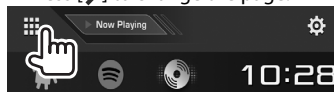

- You can also display the phone control screen:
  - By pressing TEL/VOICE on the monitor panel
  - By pressing [TEL] on the pop-up short-cut menu (Page 11)

- 2 Select a method to make a call.



- 1 From the call history\*
- 2 From the phone book\*
- 3 From the preset list
  - To preset, see page 44.
- 4 Direct number entry
- 5 Voice dialing

- You can display the <Bluetooth Setup> screen by pressing [ ].

- \* When the mobile phone is not compatible with Phone Book Access Profile (PBAP), the call history and the phone book are not displayed.

### From the call history/phone book/preset list

- 1



- [ ] From the call history (missed calls/received calls/dialed calls)
- [ ] From the phone book
- [ ] From the preset list

- 2 Select the target (1), then make a call (2).



- You can change the page to display more items by pressing [ ]/[ ].

## BLUETOOTH

- To use the A to Z search in the phone book:

1



2 Select the initial.

- If the initial character is a number, press [1,2,3...] and then select the number.



3 Select a phone number from the list.



- To display other phone numbers:

When the phone book list is displayed, you can switch between phone numbers if several phone numbers are registered for the same contact (up to 10 phone numbers per contact).

1 Switch the phone number.

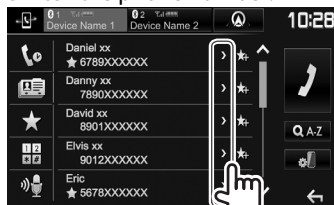

- The phone number switches each time [>] is pressed.

2 Select a phone number to call.



### Direct number entry

You can enter up to 31 numbers.



- Press [X] to delete the last entry.
- Press and hold [0/+] to add "+" to the phone number.

### Voice dialing

- Available only when the connected mobile phone has a voice recognition system.

1 Activate voice dialing.

On the phone control screen:



- You can also activate voice dialing by holding TEL/VOICE on the monitor panel.

2 Say the name of the person you want to call.

- If the unit cannot find the target, the following screen appears. Press [Start], then say the name again.



To cancel voice dialing: Press [Cancel].

## BLUETOOTH

### ❑ Presetting phone numbers

You can preset up to 5 phone numbers.

- 1 Display the phone control screen. (Page 42)
- 2 Select phone book or call history.



- 3 Select a phone number to preset.



The preset list is displayed.

- 4 Select a preset number to store into.



- To display the preset list, press [★] on the phone control screen. (Page 42)
- To delete preset phone number, press [🗑️] besides the phone number on the preset list.

### Using the Bluetooth audio player

- To register a new device, see page 38.
- To connect/disconnect a device, see page 40.
- When “**BT Audio**” is selected as the source, you can connect to five Bluetooth audio devices and switch between these five devices.

### ❑ Indications and buttons on the source control screen



- The operation buttons, indications and information displayed on the screen differ depending on the connected device.

### Playback information

- 1 Tag data (current track title/artist name/album title)\*1
  - Pressing [←] scrolls the text if not all of the text is shown.
- 2 The signal strength and battery level (Appear only when the information is acquired from the device.)
- 3 Playing time\*1
- 4 Playback status\*1
- 5 Connected device name
  - Pressing the button switches to another connected Bluetooth audio device.

### Operation buttons

- [>>] Displays the other operation button window.
  - To hide the window, press [≪≪].
- [📊] Displays the **<Equalizer>** screen. (Page 47)
- [🎧] Displays the audio menu. (Page 45)
- [⏮] [⏭] • Selects a track. (Press)
  - Reverse/forward search.\*1 (Hold)
- [▶] Starts playback.
- [⏸] Pauses playback.
- [🔀] Selects random playback mode.\*2
- [🔁] Selects repeat playback mode.\*2
- [⚙️] Displays the **<Bluetooth Setup>** screen. (Page 45)

\*1 Available only for devices compatible with AVRCP 1.3.

\*2 The random and repeat functions vary depending on the Bluetooth audio device.



## BLUETOOTH

### ❑ Selecting an audio file from the menu

1



2 Select a category (①), then a desired item (②).



- Select an item in each layer until you reach and select the desired file.
- You can change the page to display more items by pressing [**▲**]/[**▼**].
- Press [**⏪**] to return to the upper layer.

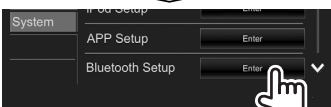
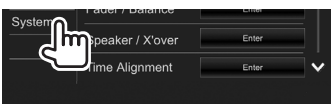

- You can also display the **<Bluetooth Setup>** screen by pressing [**ⓘ**] on the phone control screen (Page 42) or [**ⓘ**] on the “**BT Audio**” source control screen (Page 44).

2 Configure the Bluetooth settings.

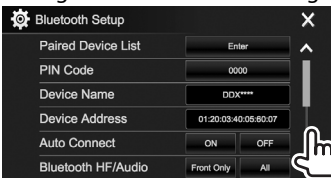

- You can change the page to display more items by pressing [**▲**]/[**▼**].

### ❑ Setting items

<b>&lt;Paired Device List&gt;</b>	Press [ <b>Enter</b> ] to show the list of registered devices. You can connect a device or delete registered devices. (Page 40)
<b>&lt;PIN Code&gt;</b>	Changes the PIN code of the unit. (Page 39)
<b>&lt;Device Name&gt;</b>	Shows the device name to be shown on the Bluetooth device — <b>DDX****</b> .

<b>&lt;Device Address&gt;</b>	Shows the device address of the unit.
<b>&lt;Auto Connect&gt;</b>	<ul style="list-style-type: none"> <li>• <b>ON</b> (Initial): A connection is automatically established with the last connected Bluetooth device when the unit is turned on.</li> <li>• <b>OFF</b>: Cancels.</li> </ul>
<b>&lt;Bluetooth HF/Audio&gt;</b>	Selects the speakers used for Bluetooth (both phone and audio player). <ul style="list-style-type: none"> <li>• <b>Front Only</b>: Front speakers only.</li> <li>• <b>All</b> (Initial): All speakers.</li> </ul>
<b>&lt;Auto Response&gt;</b>	<ul style="list-style-type: none"> <li>• <b>ON</b>: The unit answers the incoming calls automatically after 5 seconds.</li> <li>• <b>OFF</b> (Initial): The unit does not answer the calls automatically. Answer the calls manually.</li> </ul>
<b>&lt;Auto Pairing&gt;</b>	<ul style="list-style-type: none"> <li>• <b>ON</b> (Initial): Establishes pairing automatically with the connected iOS device (such as iPhone) even if the Bluetooth function is deactivated on the device. (Auto pairing may not work for some devices depending on the iOS version.)</li> <li>• <b>OFF</b>: Cancels.</li> </ul>
<b>&lt;Initialize&gt;</b>	Hold [ <b>Enter</b> ] to reset all settings you have made for using Bluetooth mobile phones and Bluetooth audio players.

## Settings for Bluetooth devices

You can change various settings for using Bluetooth devices on the **<Bluetooth Setup>** screen.

1 Display the **<Bluetooth Setup>** screen. On the Home screen:



# SETTINGS

## Settings for using applications of iPod touch/iPhone/Android

Before using applications of iPod touch /iPhone/ Android, select the device to use.

When connecting the device for the first time, the setup screen (for connection, etc.) appears. Follow the procedure on the setup screen to configure the settings.

### Preparation:

- **For Android:** Connect the Android device via Bluetooth. (Page 38)
- **For iPod touch/iPhone:**
  - Connect iPod touch/iPhone with a cable (Page 65) or via Bluetooth (Page 38).
  - Select the connection method of iPod touch/iPhone on **<iPod Setup>**. (Page 21)

- 1 Display the **<APP Setup>** screen.  
On the Home screen:

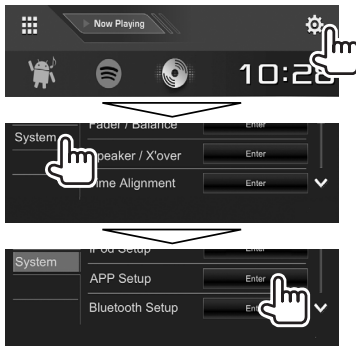

- If **[Enter]** for **<APP Setup>** cannot be selected, put the unit in standby. (Page 8)

- 2 Select the device type (①), then press **[Change]** (②).



- 3 Select the connection method (①), then confirm the selection (**[OK]** or **[Next]**) (②).

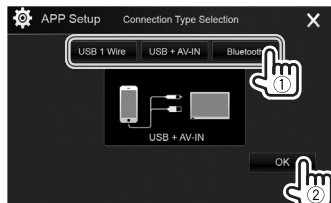

### For Android:

- **[Bluetooth]** Select this when the device is connected via Bluetooth. (Go to step 4.)

### For iPod/iPhone:

**[USB 1 Wire]** Select this when the iPod/iPhone is connected using KCA-iP102 (optional accessory) or KCA-iP103 (optional accessory).

**[USB + AV-IN]** Select this when the iPod/iPhone is connected using KCA-iP202 (optional accessory).

**[Bluetooth]** Select this when the iPod/iPhone is connected via Bluetooth. (Go to step 4.)

- 4 When selecting **[Bluetooth]** as the connection method, the paired device list appears. Select the target device (①), then press **[OK]** to connect (②).

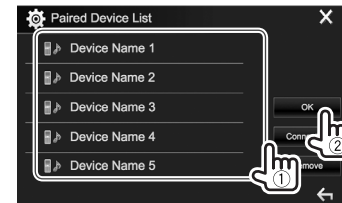

- If the device is already connected, skip step ①.

# SETTINGS

## Sound adjustment

### Using the sound equalization

- The adjustments are memorized for each source until you adjust the sound again. If the source is a disc, the adjustments are stored for each of the following categories.
  - DVD/VCD
  - CD
  - DivX/MPEG1/MPEG2/MP3/WMA/WAV/AAC/FLAC
- You cannot adjust the sound when the unit is in standby.

### Selecting a preset sound mode

- 1 Display the **<Equalizer>** screen.  
On the Home screen:

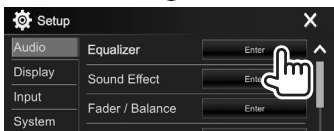
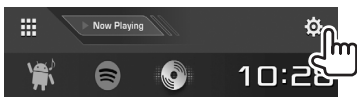

- 2 Select a sound mode.



- You can also display the **<Equalizer>** screen by pressing [ ] on the source control screen.

### Storing your own adjustments—Adjusting the sound precisely

- 1 Select a sound mode. (See the left column.)
- 2 Select a band and adjust the level of the selected band.
  - You can adjust the level by dragging the slider or using [▲]/[▼].
  - Repeat this step to adjust the level of other bands.

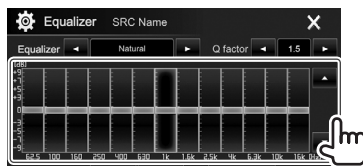

The adjustments are stored and **<User>** is activated.

- 3 Adjust the sound.



- <Q factor>** Adjusts the width of the frequency.
- <Bass EXT>** Activates ([ON])/deactivates ([OFF]) bass.
- <SW LEVEL>** Adjusts the subwoofer level.\*

- To apply the adjusted equalizer to all playback sources, press [ALL SRC], then press [OK] to confirm.
- To clear the adjustment, press [EQ INIT].

\* Not adjustable when **<None>** is selected for subwoofer on the **<Speaker Select>** screen. (Page 48)

### Setting the crossover network mode

Select the appropriate crossover network mode according to the speaker system (2-way speaker system or 3-way speaker system).

- 1 Put the unit in standby.  
On the Home screen:

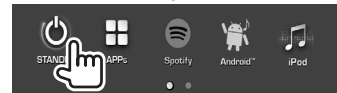
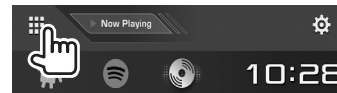

- 2 Press ▲ and MENU on the monitor panel at the same time to display the **<X'over Network>** screen.
- 3 Select the crossover network mode.

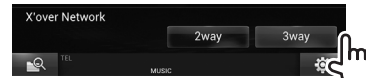

- [2way]** Select this when connecting speakers in a 2-way system (front/rear).
- [3way]** Select this when connecting speakers in a 3-way system (tweeter/mid range/woofer).

A confirmation message appears. Press [Yes].

## SETTINGS

### ❑ Setting the speakers—car type, speaker size and crossover frequency

#### Preparation:

Select the appropriate crossover network mode beforehand. (Page 47)

- 1 Display the **<Car Setting>** screen.  
On the Home screen:

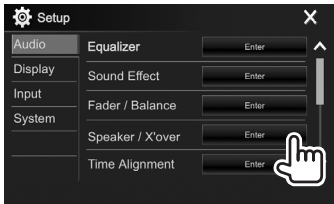

- 2 Select a car type (1), select the location of the speakers (2)\*1, then display the **<Speaker Select>** screen (3).



- 3 Select the speaker type (1), select the size of the selected speaker (2), then display the **<X'over>** screen (3).

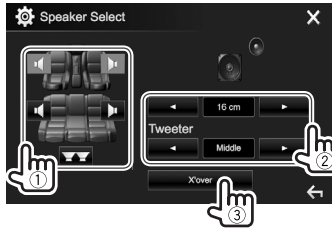

- When a speaker is not connected, select **<None>**.
- When setting the front speakers, also select the speaker size for **<Tweeter>**.

- 4 Adjust the crossover frequency of the selected speaker.

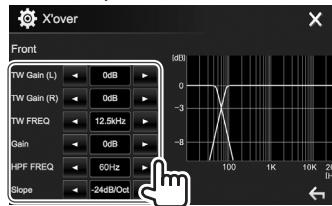

- <TW Gain (L)>/<TW Gain (R)>** Adjusts the output volume of the tweeter (left/right).\*2\*3
- <TW FREQ>** Adjusts the crossover frequency for the tweeter.\*2\*3
- <Gain>** Adjusts the output volume of the selected speaker.
- <HPF FREQ>** Adjusts the crossover frequency for the front or rear speakers (high pass filter).\*4
- <LPF FREQ>** Adjusts the crossover frequency for the subwoofer (low pass filter).\*5
- <Slope>** Adjusts the crossover slope.\*6
- <Phase>** Selects the phase for the subwoofer.\*5

\*1 Speaker location selection is available only when **<X'over Network>** is set to **[2 way]**. (Page 47)

\*2 Appears only when the front speakers are selected.

\*3 Adjustable only when **<Tweeter>** is set to **<Small>**, **<Middle>**, or **<Large>** on the **<Speaker Select>** screen.

\*4 Appears only when the front/tweeter or rear/mid range speakers are selected.

\*5 When **<X'over Network>** is set to **[2 way]** (Page 47): Appears only when the subwoofer is selected.

\*6 Not adjustable when **<HPF FREQ>** or **<LPF FREQ>** is set to **<Through>**.

## SETTINGS

### ❑ Adjusting the Digital Time Alignment (DTA)

Make fine adjustments to the delay time of the speaker output to create a more suitable environment for your vehicle.

- 1 Display the **<Time Alignment>** screen. On the Home screen:

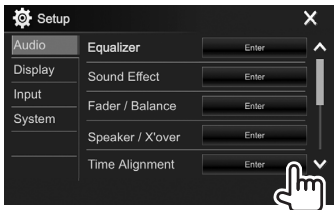

- 2 Select the listening position (**<All>**, **<Front L>**, **<Front R>** or **<Front All>**\*).

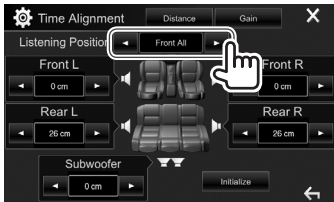

- 3 Select an item to make an adjustment.

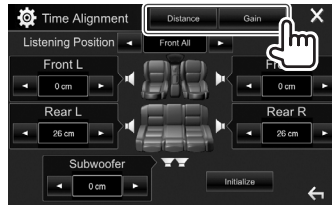

**[Distance]** Adjusts the Digital Time Alignment (DTA) value.

**[Gain]** Adjusts the output volume of the selected speaker.

- 4 Adjust each speaker setting.

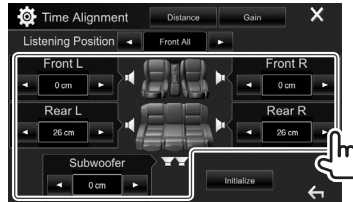

- To determine the adjustment value, see the right column.
- To initialize the setting value, press **[Initialize]**.

\* **<Front All>** is selectable only when **<X'over Network>** is set to **[2way]**. (Page 47)

### Determining the value for **<Position DTA>** adjustment

If you specify the distance from the center of the currently set listening position to every speaker, the delay time will be automatically computed and set.

- ① Determine the center of the currently set listening position as the reference point.
- ② Measure the distances from the reference point to the speakers.
- ③ Calculate the differences between the distance of the furthest speaker and other speakers.
- ④ Set the DTA value calculated in step ③ for individual speakers.
- ⑤ Adjust gain for individual speakers.

Example: When **<Front All>** is selected as the listening position

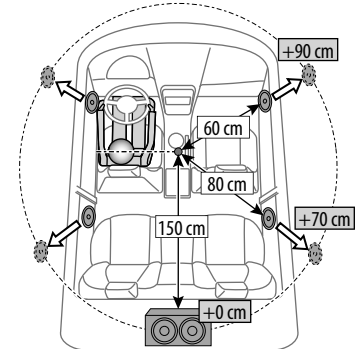

## SETTINGS

### Adjustment for video playback

#### Adjusting the picture

You can adjust the picture quality.

- 1 Display the picture adjustment screen.  
On the source control screen:

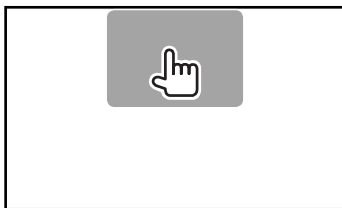

- 2 Select **[DIM ON]** (dimmer on) or **[DIM OFF]** (dimmer off) (1), then adjust the picture (2).



- <Bright>** Adjusts the brightness. (-15 to +15)
- <Contrast>** Adjusts the contrast. (-10 to +10)
- <Black>** Adjusts the blackness. (-10 to +10)
- <Color>** Adjusts the color. (-10 to +10)
- <Tint>** Adjusts the tint. (-10 to +10)
- <Sharpness>** Adjusts the sharpness. (-2 to +2)

- You can also display the picture adjustment screen by selecting **[Screen Adjustment]** on the pop-up short-cut menu (Page 11).

#### Changing the aspect ratio



You can change the aspect ratio for video playback.

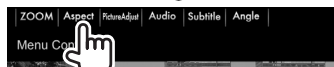
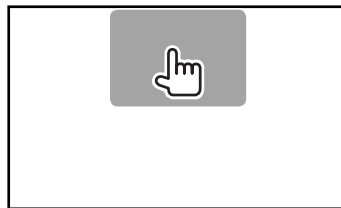

- 1 Display the aspect ratio selection screen.  
On the source control screen:





- 2 Select the aspect ratio.



- <FULL>\*** For 16:9 original pictures
- |   |   |
|---|---|
| 4:3 signal  | 16:9 signal   |
|  |  |

- <JUST>** For viewing 4:3 pictures naturally on the wide screen
- |   |   |
|---|---|
| 4:3 signal  | 16:9 signal   |
|  |  |

- <Normal>\*** For 4:3 original pictures
- |   |   |
|---|---|
| 4:3 signal  | 16:9 signal   |
|  |  |

- <Auto>** For "DISC"/"USB" only: The aspect ratio is automatically selected to match the incoming signals.

\* While DivX is played back with **<Screen Ratio>** set to **[16:9]** (Page 16 for discs/Page 18 for USB), the aspect ratio may not set correctly.

## SETTINGS

### ❑ Zooming the picture

You can zoom the picture (<FULL>, <Zoom1> to <Zoom3>).

- When <Aspect> is set to <JUST> or <Auto> (Page 50), the picture is zoomed with the aspect ratio of the <FULL> setting.

#### 1 Display the magnification level selecting screen.

On the source control screen:

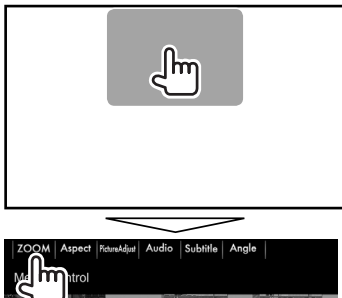

#### 2 Change the magnification (①), then move the zooming frame (②).



- The zoom function cannot be used for some video sources.

### Changing the display design

You can change the background and panel color.

#### 1 Display the <User Customize> screen.

On the Home screen:

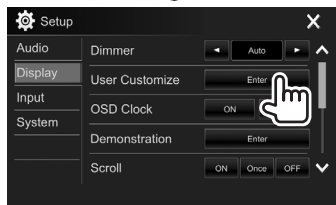
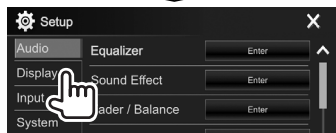
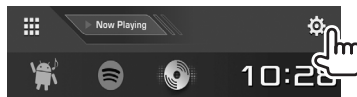

#### 2 Select an item to change (background design: [Background]/panel color: [Panel Color]\*1).

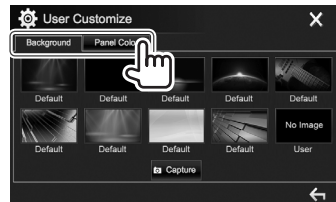

#### 3 Select a background/panel color.

##### To select a background

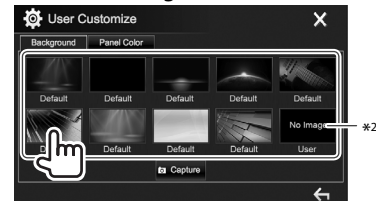

##### To select a panel color\*1

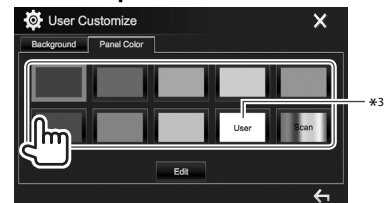

- Selecting [Scan] changes the illumination color gradually.

\*1 The panel color is selectable only for DDX4017DAB/DDX4017BT/DDX4017BTR.

\*2 Store your own scene beforehand. (Page 52)

\*3 Store your own color adjustment beforehand. (Page 52)

## SETTINGS

### ❑ Making your own color adjustment (Only for DDX4017DAB/DDX4017BT/ DDX4017BTR)

1 Select [**Panel Color**] on the <User Customize> screen. (Page 51)

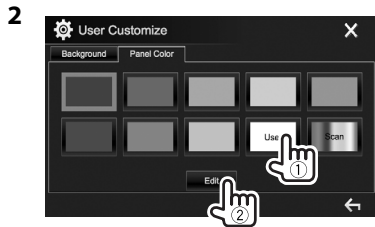

3 Select the dimmer setting for the color (①), then adjust the color (②).

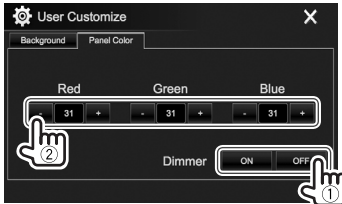

### ❑ Storing your own scene for the background image

While playing a video or picture, you can capture an image and use the captured image as a background.

- You cannot capture copyrighted content and images from iPod/iPhone.
- When using a JPEG file as the background, make sure that the resolution is 800 x 480 pixels.
- The color of the captured image may look different from that of the actual scene.

- 1 Play a video or picture.
- 2 Display the <User Customize> screen. (Page 51)
- 3 Display the image adjustment screen.

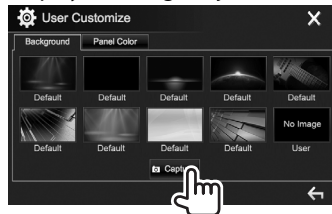

4 Adjust the image.

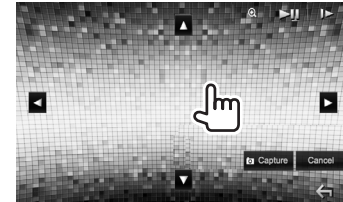

- [▲][▼][◀][▶] Moves the zooming frame.
- [+] Magnifies the scene. (<OFF>, <Zoom1> – <Zoom3>)
- ▶||]\* Starts/pauses playback.
- [▶]\* Advances scenes frame-by-frame.

- To cancel the capture, press [**Cancel**].

5 Capture the image displayed on the screen.



A confirmation message appears. Press [**Yes**] to store the newly captured image. (The existing image is replaced with the new one.)

- Press [**No**] to return to the previous screen.

\* Not displayed when playing an external component connected to the iPod/AV-IN input terminal.



# SETTINGS

## Customizing the Home screen

You can arrange the items to display on the Home screen.

- 1 Display the **<Home Customize>** screen. On the Home screen:
  - You can change the page to display more items by pressing [▲]/[▼].



- 2 Select the position to place the icon (①), then select the item you want to display in the selected position (②).



Repeat this step to place icons for other items.

## Customizing the system settings

### Memorizing/recalling the settings

- You can memorize the settings changed in the **<Setup>** menu and recall the memorized settings any time.
- The memorized settings are kept even when the unit is reset.

- 1 Display the **<SETUP Memory>** screen. On the Home screen:
  - You can change the page to display more items by pressing [▲]/[▼].



2

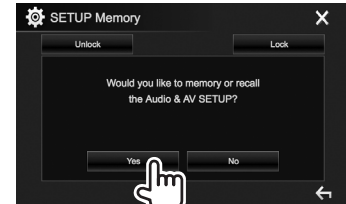

- To cancel, press **[No]**.

3

Select an operation.

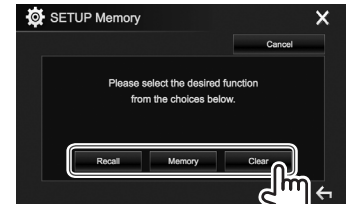

**[Recall]** Recalls the memorized settings.

**[Memory]** Memorizes the current settings.

**[Clear]** Clears the currently memorized settings.

- To cancel, press **[Cancel]**.

A confirmation message appears. Press **[Yes]**.

## SETTINGS

### ❑ Locking the settings

You can lock the settings to prevent them from being changed.

-  is shown beside the settings that can be locked.

- 1 Display the **<SETUP Memory>** screen.  
(Page 53)



**To unlock the setting:** Press [Unlock].

### ❑ Updating the system

You can update the system by connecting a USB device containing an update file.

- To update the system, visit <http://www2.jvckenwood.com/cs/ce/>.

- 1 Create an update file and copy it to a USB device.

- 2 Display the **<System Information>** screen.

On the Home screen:

- You can change the page to display more items by pressing []/[].

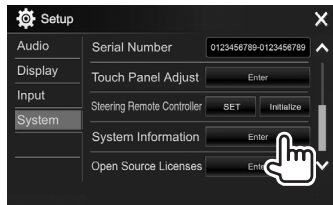
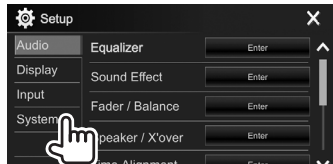

3

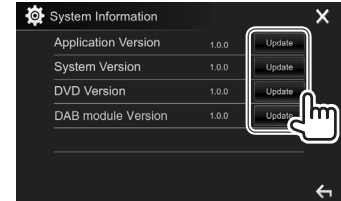

**<Application Version>** Updates the system application.

**<System Version>** Updates the system.

**<DVD Version>** Updates the DVD system application.

**<DAB module Version>\*** Updates the Digital Radio (DAB) module application.

- 4 Connect the USB device with the update file.

- To connect a USB device, see page 65.

The system update starts. It may take a while. If the update has been completed successfully, "Update Completed" appears. Reset the unit.

- Do not disconnect the USB device while updating.
- If the update has failed, turn the power off and then on, and retry the update.
- Even if you have turned off the power during the update, you can restart the update after the power is turned on. The update will be performed from the beginning.

\* Only for DDX4017DAB.

## SETTINGS

### ❑ Adjusting the touch position

You can adjust the touch position on the touch panel if the position touched and the operation performed do not match.

#### 1 Display the <Touch Panel Adjust> screen.

On the Home screen:

- You can change the page to display more items by pressing [**▲**]/[**▼**].

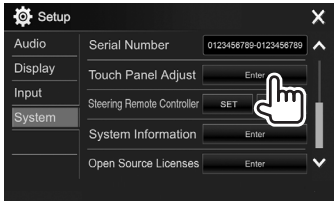
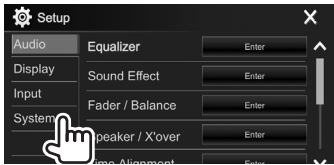
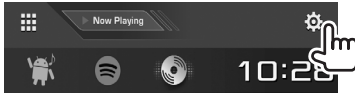

#### 2 Touch the center of the marks at the upper left (①), the lower center (②), then the upper right (③) as instructed.

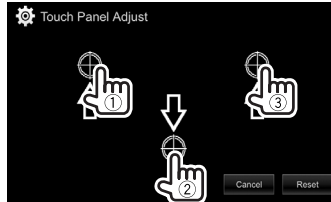

- To reset the touch position, press [**Reset**].
- To cancel the current operation, press [**Cancel**].

### Setting menu items

#### ❑ Displaying the <Setup> menu screen

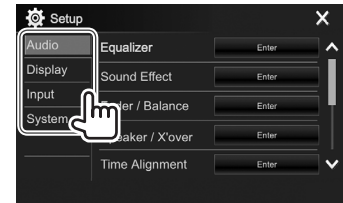
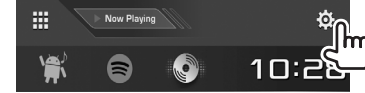

- You can change the page to display more items by pressing [**▲**]/[**▼**].
- You can also display the <Setup> screen by selecting [**SETUP**] on the pop-up short-cut menu (Page 11).
- You cannot change the <Audio> settings screen in the following situations:
  - When the unit is in standby (Page 8)
  - When the Bluetooth phone is used (making or receiving a call, during a call, or while voice dialing)
  - During navigation guidance\*

\* Only for DDX4017DAB/DDX4017BT.

## SETTINGS

### ☐ <Audio> setting screen

#### <Equalizer>

Change the sound mode or adjust and store the equalization for each source. (Page 47)

- **Equalizer:** Selects the preset sound mode.
  - **Natural** (Initial)/**Rock/Pops/Easy/Top40/Jazz/Powerful/User**
- **Q factor:** Adjusts the width of the frequency.
  - **1.35/1.5** (Initial)/**2.0**
- **Bass EXT:** Activates/deactivates bass.
  - **ON/OFF** (Initial)
- **SW LEVEL:** Adjusts the subwoofer level.
  - **-50 to +10** (Initial: **0**)

#### <Sound Effect>

Adjust the sound effect.

- **Loudness:** Adjusts loudness.
  - **OFF** (Initial)/**Low/High**
- **Bass Boost:** Selects the bass boost level.
  - **OFF** (Initial)/**Level 1/Level 2/Level 3/Level 4/Level 5**
- **Drive Equalizer:** You can reduce the driving noise by raising the bandwidth.
  - **OFF** (Initial)/**ON**
- **Space Enhancer**\*<sup>1</sup>: Virtually enhances the sound space using the Digital Signal Processor (DSP) system. Select the enhance level.
  - **OFF** (Initial)/**Small/Medium/Large**

- **Supreme**\*<sup>2</sup>: Restores the sound lost due to audio compression to a realistic sound.
  - **OFF/ON** (Initial)
- **Realizer:** Virtually makes the sound more realistic using the Digital Signal Processor (DSP) system. Select the sound level.
  - **OFF** (Initial)/**Level 1/Level 2/Level 3**
- **Stage EQ:** You can move the center of the sound to the lower or higher point. Select the height.
  - **OFF** (Initial)/**Low/Middle/High**

#### <Fader/Balance>

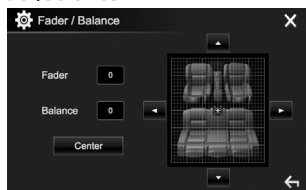

**Fader:** Adjusts the front and rear speaker output balance.

- **F15 to R15** (Initial: **0**)
  - When using a two-speaker system, set the fader to the center (**0**).

**Balance:** Adjusts the left and right speaker output balance.

- **L15 to R15** (Initial: **0**)

Press [▲]/[▼]/[◀]/[▶] or drag [👆] to adjust.

- To clear the adjustment, press [Center].

#### <Speaker/X'over>

Select the car type/speaker size and adjust the crossover frequency. (Page 48)

#### <Time Alignment>

Select the listening position, then adjust the delay time of the speaker output to create a more suitable environment for your vehicle. (Page 49)

#### <Volume Offset>

Adjust and store the auto-adjustment volume level for each source. (For discs, the adjustment is stored for each of the following categories: DVD/VCD, CD, and DivX/MPEG1/MPEG2/MP3/WMA/WAV/AAC/FLAC.) The volume level will automatically increase or decrease when you change the source.

- **-15 to +6** (Initial: **00**)

\*<sup>1</sup> You cannot change the setting when “Radio” or “DAB” (only for DDX4017DAB) is selected as the source.

\*<sup>2</sup> This function works only when “DISC”/“USB”/“iPod”/“Android”<sup>™</sup> is selected as the source.

## SETTINGS

### ☐ <Display> setting screen

#### <Dimmer>

- **Auto** (Initial): Dims the screen and button illumination when you turn on the headlights.
- **ON**: Activates dimmer.
- **OFF**: Cancels.
- **NAV**\*1: Activates or deactivates dimmer according to the day/night display setting of the connected navigation unit.

#### <User Customize>

Change the display design. (Page 51)

#### <OSD Clock>

- **ON**: Displays the clock while a video source is playing.
- **OFF** (Initial): Cancels.

#### <Demonstration>

- **ON** (Initial): Activates the demonstration on the screen.
- **OFF**: Cancels.

#### <Scroll>

- **ON** (Initial): Scrolls the displayed information repeatedly.
- **Once**: Scrolls the displayed information once.
- **OFF**: Cancels.

Pressing [<] scrolls the text regardless of this setting.

#### <Home Customize>

Change the items to display on the Home screen. (Page 53)

### <Screen Adjustment>

Adjust the brightness and blackness of the screen. Press [**Enter**] to display the setting screen, select [**DIM ON**] (dimmer on)/[**DIM OFF**] (dimmer off), then change the following settings:

- **Bright**: Adjusts brightness.
  - **-15 to +15** (Initial: **0** for dimmer on/+**15** for dimmer off)
- **Black**: Adjusts blackness.
  - **-10 to +10** (Initial: **0**)

### <Video Output>\*2

Select the color system of the external monitor.

- **NTSC/PAL** (Initial)

### <Viewing Angle>

Select the viewing angle in relation to the monitor panel to make the panel easier to see.

- **Under 0°** (Initial)/**5°/10°/15°/20°**

\*1 Only for DDX4017 DAB/DDX4017BT.

\*2 "Please Power Off" appears when the setting is changed. Turn off the power, then turn on to enable the change.

### ☐ <Input> setting screen

#### <Rear Camera>

Configure the rear view camera settings.

- **Rear Camera Interruption** (Page 34):
  - **ON**: Displays the picture from the rear view camera when you shift the gear to the reverse (R) position.
  - **OFF** (Initial): Select this when no camera is connected.
- **Parking Guidelines**: Displays (**ON**: Initial) or hides (**OFF**) the parking guidelines. (Page 35)
- **Guidelines Setup**: Adjusts the parking guidelines. (Page 35)

#### <Navigation>\*

Change the navigation settings. (Page 37)

\* Only for DDX4017DAB/DDX4017BT.

## SETTINGS

### ☐ <System> setting screen

#### <Language>\*1

Select the text language used for on-screen information.

- **English** (Initial for DDX4017DAB/DDX4017BT/DDX317BT)/**Español/Français/Deutsch/Italiano/Nederlands/Ελληνικά/Português/Türkçe/Čeština/Polski/Magyar/Русский** (Initial for DDX4017BTR)/**עברית/العربية/فارسی/زبان فارسی/عبرית/فارسی/عبرית/فارسی**  
– For external monitors, only English/Spanish/French/German/Italian/Dutch/Russian/Portuguese are available. If another language has been selected, the text language for external monitors will be set to English.
- **GUI Language:** Selects the language used for displaying operation buttons and menu items.
  - **Local** (the language selected above)/**English** (Initial)

#### <Clock>

Adjust the clock time. (Page 5)

#### <iPod Setup>

Specify the connection method of iPod/iPhone. (Page 21)

#### <APP Setup>

Configure the App setup. (Page 46)

#### <Bluetooth Setup>

Configure settings for using a Bluetooth device, such as connection and other general operations. (Page 45)

#### <Beep>

- **ON** (Initial): Activates the key-touch tone.
- **OFF:** Cancels.

#### <SETUP Memory>

You can memorize, recall, or clear the settings you have made. (Page 53)

#### <DivX(R) VOD>

This unit has its own Registration Code. Once you have played back a file with the Registration Code recorded, this unit's Registration Code is overwritten for copyright protection.

- Press [**Enter**] to display the information.
- To return to the previous screen, press [**OK**].

#### <Security Code>

Register the security code for the unit. (Page 4)

#### <SI>

Activate or deactivate the security function. (Page 5)

#### <Serial Number>\*2

Displays the serial number.

#### <Touch Panel Adjust>

Adjust the touch positions of the buttons on the screen. (Page 55)

#### <Steering Remote Controller>\*3

Assign functions to the keys on the remote controller of the steering wheel. (Page 61)

#### <System Information>

Displays the version information of the software. You can update the software. (Page 54)

#### <Open Source Licenses>

Shows the Open Source Licenses.

\*1 "Please Power Off" appears when the setting is changed. Turn off the power, then turn on to enable the change.

\*2 Only for DDX4017DAB/DDX4017BT.

\*3 Only for DDX4017DAB/DDX4017BT/DDX4017BTR.

# REMOTE CONTROLLER

## Overview

Optional Remote Controller KNA-RCDV331 is designed for controlling this unit. Refer to the instruction manual that comes with the remote controller.

### ⚠ Caution:

- Put the Remote Controller in a place where it will not move during braking or other operations. A dangerous situation could result if the Remote Controller falls down and gets wedged under the pedals while driving.
- Do not leave the battery near fire or under direct sunlight. A fire, explosion or excessive heat generation may result.
- Do not recharge, short, break up or heat the battery, or place it in an open fire. Such actions may cause the battery to leak fluid. If spilled fluid comes in contact with your eyes or clothing, immediately rinse with water and consult a physician.
- Place the battery out of reach of children. In the unlikely event that a child swallows the battery, immediately consult a physician.

You can also operate this unit from Smartphone using KENWOOD Remote APP. For details, visit <<http://www.kenwood.com/cs/ce/>>.

## ❑ Battery installation

Use two "AAA"/"R03"-size batteries.

Insert the batteries with the + and – poles aligned properly, following the illustration inside the case.

- Always insert batteries from – poles to avoid bending the springs.

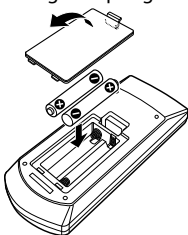

- If the Remote Controller operates only over shorter distances or does not operate at all, it is possible that the batteries are depleted. In such instances, replace both batteries with new ones.

## ❑ Remote Controller mode switch

The functions operated from the remote controller differ depending on the position of the mode switch.

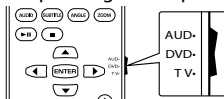

**AUD mode:** Switch to this mode when controlling a selected source or tuner source, etc.

**DVD mode:** Switch to this mode when playing DVDs or CDs etc. with the player integrated in this unit.

**TV mode:** Not used.

- The position of the remote control mode switch is indicated in the title of each mode, e.g., "AUD mode".
- When controlling a player that is not integrated in the unit, select "AUD" mode.

## Operations from the remote controller

### ❑ Common operations (AUD mode)

SRC	<ul style="list-style-type: none"><li>• Selects the source.</li><li>• Hangs up the incoming/current call.</li></ul>
▲/▼ VOL	Adjusts the volume level.
ATT	Attenuates/restores the sound.
DISP/V.SEL	For DDX4017DAB/DDX4017BT: Switches between the current source control screen and the navigation screen. For DDX4017BTR/DDX317BT: Switches to the current source control screen.
ENTER	Enters options.
	Answers incoming calls.
FNC/PBC/MENU	Switches the control screen.
MODE/TOP MENU	Changes the aspect ratio. <ul style="list-style-type: none"><li>• The aspect ratio changes each time you press this key.</li></ul>
OPEN	Not used for this unit.

## REMOTE CONTROLLER

### ❑ DVD/VCD (DVD mode)

	Moves the cursor when displaying a menu.
	Selects a track.
	Starts/pauses playback.
	Stops and memorizes the point where the disc stops.
0 – 9	<ul style="list-style-type: none"> <li>Specifies the number to search for in direct search.</li> <li>  : Fast forwards/backwards. <ul style="list-style-type: none"> <li>– Fast forward/backward speed changes each time you press this key.</li> </ul> </li> <li>  : Slow forwards/backwards during pause.</li> </ul>
MODE/TOP MENU	Shows the disc top menu.
FNC/PBC/MENU	Shows the disc menu.
SUBTITLE	Changes the subtitle language.
ZOOM	Changes the zoom ratio. <ul style="list-style-type: none"> <li>The zoom ratio changes each time you press this key.</li> </ul>
ANGLE	Changes the picture angle. <ul style="list-style-type: none"> <li>The picture angle changes each time you press this key.</li> </ul>
AUDIO	Changes the voice language. <ul style="list-style-type: none"> <li>The voice language changes each time you press this key.</li> </ul>
DIRECT	Enters direct search mode. (See the far right column.)
CLEAR	Deletes a character while in direct search mode.

### ❑ Music Disc/Audio file/Video file/Picture file (AUD mode)

AM –/FM +	Selects a folder.
	Selects a track/file.
	Starts/pauses playback.
0 – 9	Specifies the number to search for in direct search.
DIRECT	Enters direct search mode. (See the right column.)

### ❑ Radio (AUD mode)

AM –/FM +	Selects the band.
	Searches for stations.*
	Changes the seek mode (AUTO1, AUTO2, MANU).
0 – 9	<ul style="list-style-type: none"> <li>Specifies preset number. ( – )</li> <li>Specifies the frequency of the station to receive to search for in direct search.</li> </ul>
DIRECT	Enters direct search mode. (See the right column.)

\* The search method differs according to the selected seek mode.

### ❑ Digital Radio (DAB) (AUD mode)\*

	Searches for services.
	Changes the seek mode (AUTO1, AUTO2, MANU).
1 – 5	Specifies preset number.

\* Only for DDX4017DAB.

### ❑ iPod/Android (AUD mode)

	Selects music/videos.
	Starts/pauses playback.

### ❑ USB (AUD mode)

AM –/FM +	Selects a folder.
	Selects a file.
	Starts/pauses playback.

#### Searching for an item (chapter/title/folder/file/track) directly

- Press DIRECT to enter the search mode. Each time you press DIRECT, the item to search for changes.
- Press a number button to select a desired item.
- Press ENTER to confirm the selection.

#### Searching for a tuner frequency directly

- Press DIRECT to enter the search mode.
- Press number buttons to enter a frequency.
- Press to confirm the entry.



## REMOTE CONTROLLER

### Using the steering remote controller (Only for DDX4017DAB/DDX4017BT/DDX4017BTR)

You can assign functions to the keys of the remote controller on the steering wheel.

- This function is available only when your vehicle is equipped with the electrical steering remote controller.
- You can only register/change the functions while you are parked.
- If your steering remote controller is not compatible, learning may not be completed and an error message may appear.

#### ❑ Registering/changing the functions

- 1 Display the <System> setting screen. On the Home screen:



- 2 Display the <Steering Remote Control Setting> screen.

- You can change the page to display more items by pressing [**▲**]/[**▼**].

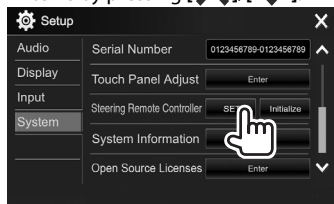

- 3 Press and hold a steering remote controller button to register/change.

- 4 Select a function to assign.

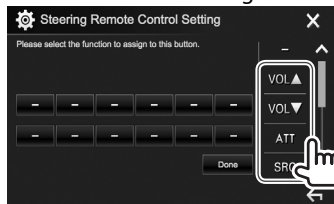

- You can change the page to display more items by pressing [**▲**]/[**▼**].

- 5 Repeat steps 3 and 4 as necessary.

- 6 Finish the procedure.

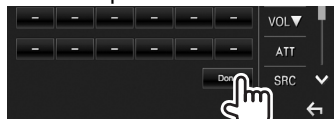

- The unit can register/change all of the buttons' functions at the same time. To do this, press each button in turn and after pressing all of them, press [**Done**] on the <Steering Remote Control Setting> screen. However, new functions cannot be learned after this operation.
- When changing the functions already learned, touch the button you want to change in step 3 and then touch to select the new function from the function list.
- Confirm the contents of the settable functions in the function list. You cannot edit the function list.

#### ❑ Initializing the settings

- 1 Display the <System> setting screen. (See the far left column.)

- You can change the page to display more items by pressing [**▲**]/[**▼**].

- 2

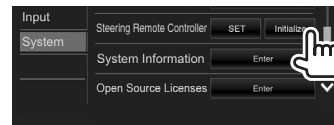

- 3



- To cancel the initialization, press [**No**].

# CONNECTION/INSTALLATION

## Before installing the unit

### ⚠ WARNING

- If you connect the ignition wire (red) and the battery wire (yellow) to the car chassis (ground), you may cause a short circuit, that in turn may start a fire. Always connect those wires to the power source running through the fuse box.
- Do not cut out the fuse from the ignition wire (red) and the battery wire (yellow). The power supply must be connected to the wires via the fuse.

### ⚠ Precautions on installation and connection

- Mounting and wiring this product requires skills and experience. For best safety, leave the mounting and wiring work to professionals.
- Make sure to ground the unit to a negative 12 V DC power supply.
- Do not install the unit in a location exposed to direct sunlight or excessive heat or humidity. Also avoid places with too much dust or the possibility of water splashing.
- Do not use your own screws. Use only the screws provided. If you use the wrong screws, you could damage the unit.
- If the power is not turned on ("Miswiring DC Offset Error", "Warning DC Offset Error" is displayed), the speaker wire may have a short circuit or have touched the chassis of the vehicle and the protection function may have been activated. Therefore, the speaker wire should be checked.
- Keep all cables away from heat dissipating metal parts.

- If your car's ignition does not have an ACC position, connect the ignition wires to a power source that can be turned on and off with the ignition key. If you connect the ignition wire to a power source with a constant voltage supply, such as with battery wires, the battery may be drained.
- If the fuse blows, first make sure the wires are not touching to cause a short circuit, then replace the old fuse with one with the same rating.
- Insulate unconnected wires with vinyl tape or other similar material. To prevent a short circuit, do not remove the caps on the ends of the unconnected wires or the terminals.
- Connect the speaker wires correctly to the terminals to which they correspond. The unit may be damaged or fail to work if you share the ⊖ wires or ground them to any metal part in the car.
- When only two speakers are being connected to the system, connect both connectors either to the front output terminals or to the rear output terminals (do not mix front and rear). For example, if you connect the ⊕ connector of the left speaker to a front output terminal, do not connect the ⊖ connector to a rear output terminal.
- After the unit is installed, check whether the brake lamps, blinkers, wipers, etc. on the car are working properly.
- Mount the unit so that the mounting angle is 30° or less.
- Do not press hard on the panel surface when installing the unit to the vehicle. Otherwise scratches, damage, or failure may result.

### ⚠ CAUTION

- Install this unit in the console of your vehicle. Do not touch the metal parts of this unit during and shortly after the use of the unit. Metal parts such as the heat sink and enclosure become hot.
- When parking at a low ceiling area, turn off the unit to store the antenna. As when the unit is installed in the car with the function of auto antenna; the radio antenna extends automatically when you turn on the unit with the antenna control wire (ANT CONT) connected. (Page 64)

## ▣ Supplied accessories for installation

- ① Wiring harness x 1
- ② Trim plate x 1
- ③ Extension wire (2 m) x 1
- ④ Extraction keys x 2
- ⑤ Microphone (3 m) x 1

## CONNECTION/INSTALLATION

### ❑ Installation procedure

- 1 To prevent a short circuit, remove the key from the ignition and disconnect the ⊖ battery.
- 2 Make the proper input and output wire connections for each unit.
- 3 Connect the speaker wires of the wiring harness.
- 4 Take Connector B on the wiring harness and connect it to the speaker connector in your vehicle.
- 5 Take Connector A on the wiring harness and connect it to the external power connector in your vehicle.
- 6 Connect the wiring harness connector to the unit.
- 7 Install the unit in your car.
  - Make sure that the unit is installed securely in place. If the unit is unstable, it may malfunction (eg, the sound may skip).
- 8 Reconnect the ⊖ battery.
- 9 Press the reset button. (Page 3)
- 10 Configure <Initial Setup>. (Page 4)

### Installing the unit

#### ❑ Installing the unit

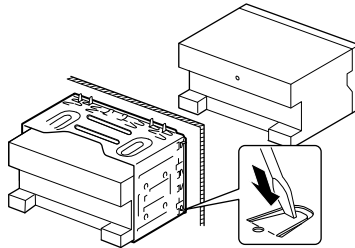

- Bend the tabs of the mounting sleeve with a screwdriver or similar utensil and attach it in place.

#### ❑ Installing the trim plate

Attach the trim plate (2).

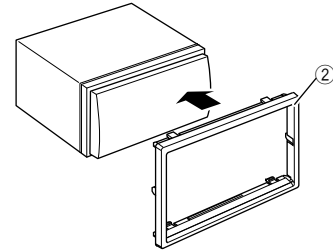

# CONNECTION/INSTALLATION

## Connection

### Connecting wires to terminals

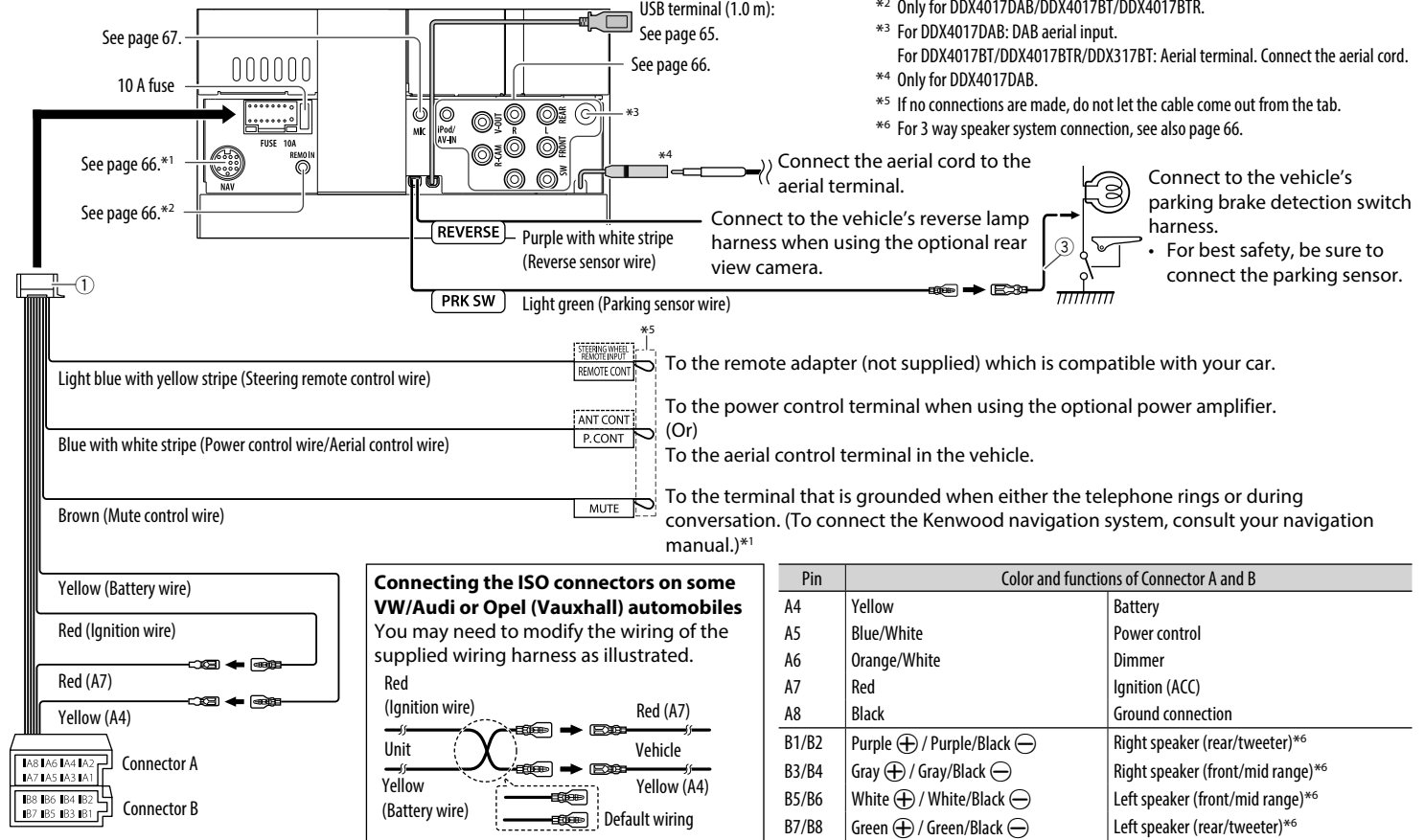

# CONNECTION/INSTALLATION

## ❑ Connecting a USB device

**USB device\***  
(commercially available)

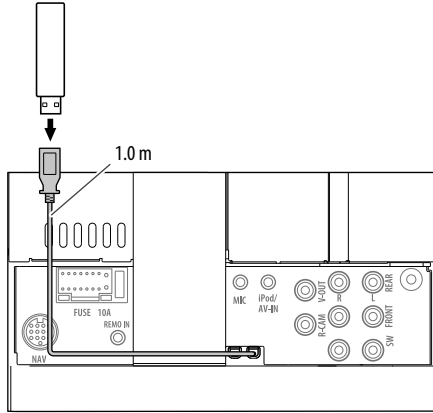

\* Use CA-U1EX for extending the cable if necessary. (Max 500 mA, 5V)

## ❑ Connecting an Android device

**Android device** (commercially available)

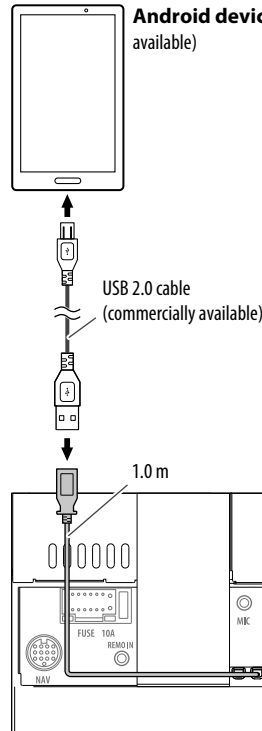

## ❑ Connecting iPod/iPhone

**iPod/iPhone (Lightning connector models)**  
(commercially available)

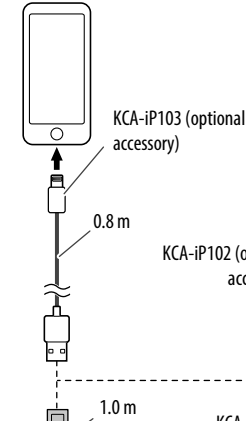

**iPod/iPhone (30-pin connector models)**  
(commercially available)

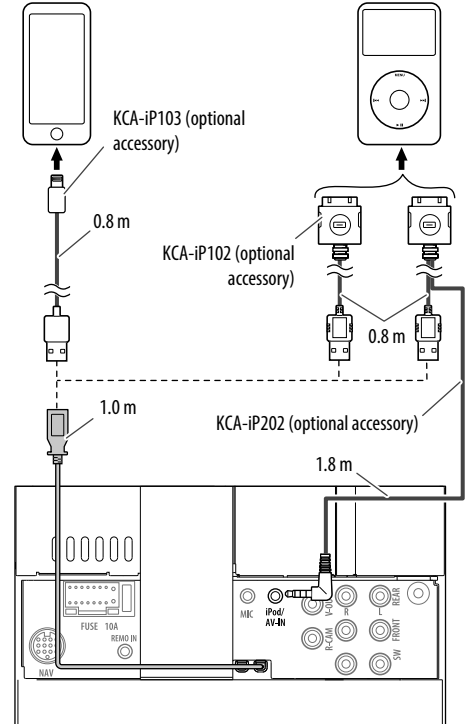

## CONNECTION/INSTALLATION

### Connecting external components

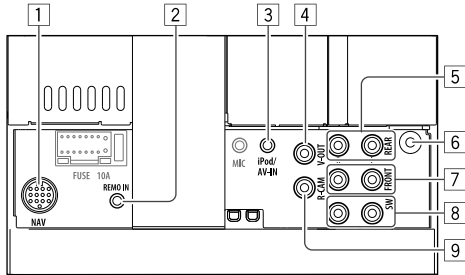

- 1 NAVI I/F input\*<sup>1</sup>
- 2 Steering wheel remote controller input\*<sup>2</sup>
  - Connect to the vehicle's steering remote harness. Contact your Kenwood dealer for details.
- 3 iPod/Audio Video input (iPod/AV-IN)\*<sup>3</sup>
- 4 Video output (Yellow)
- 5 Rear preout\*<sup>4</sup>
  - Audio left output (White)
  - Audio right output (Red)

- 6 DAB aerial input\*<sup>5</sup> / Aerial terminal\*<sup>6</sup>
- 7 Front preout\*<sup>4</sup>
  - Audio left output (White)
  - Audio right output (Red)
- 8 Subwoofer preout\*<sup>4</sup>
  - Subwoofer left output (White)
  - Subwoofer right output (Red)
- 9 Rear view camera input (Yellow)

\*1 Only for DDX4017DAB/DDX4017BT.

\*2 Only for DDX4017DAB/DDX4017BT/DDX4017BTR.

\*3 When connecting the component to play on **"AV-IN"**, use the Audio and Video cable CA-C3AV (optional accessory).

\*4 When connecting an external amplifier, connect its ground wire to the chassis of the car; otherwise the unit may be damaged.

\*5 For DDX4017DAB. To use the digital radio, connect CX-DAB1 (optional accessory).

\*6 For DDX4017BT/DDX4017BTR/DDX317BT: Connect the aerial cord.

### Connecting external amplifiers for a 3 way speaker system

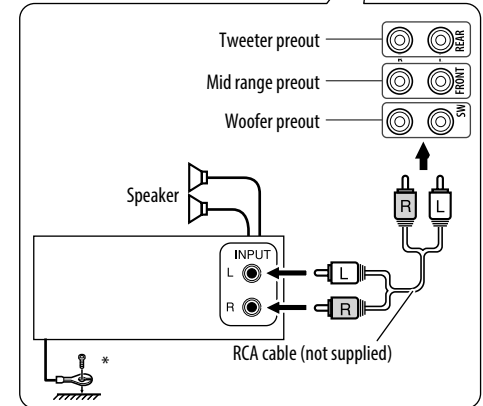
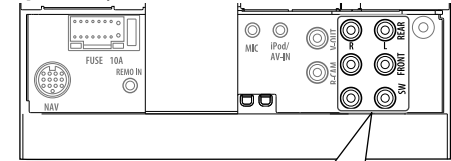

\* When connecting to an external amplifier, connect its ground wire to the car's chassis.

## CONNECTION/INSTALLATION

### ❑ Connecting microphone for Bluetooth

Connect the microphone (5) to the MIC terminal.

- To install the microphone, peel off the adhesive tape, fix on the installation position, then adjust the direction of the microphone to face the driver. After installing, fix the microphone cable to the car with clamps (commercially available).

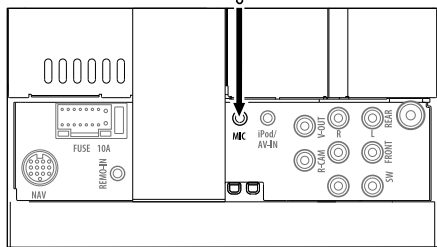
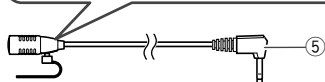
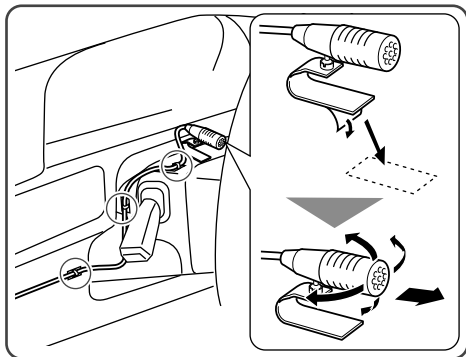

### Removing the unit

#### ❑ Removing the trim plate

- 1 Engage the catch pins on the extraction key (4) and remove the two locks on the lower part. Lower the frame and pull it forward.

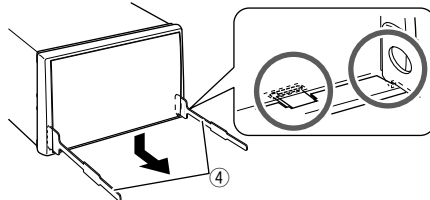

- 2 Remove from the upper two catches.

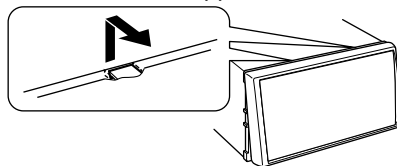

- The frame can be removed from the top side in the same manner.

#### ❑ Removing the unit

- 1 Remove the trim plate. (See the left column.)
- 2 Insert the two extraction keys (4), then pull them as illustrated so that the unit can be removed.

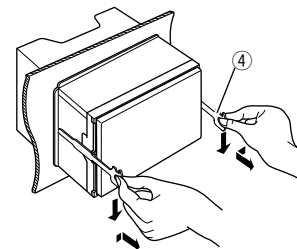

- Be careful to avoid injury from the catch pins on the extraction key.

# REFERENCES

## Maintenance

### ❑ Caution on cleaning the unit

Do not use any solvent (for example, thinner, benzine, etc.), detergent, or insecticide. This may damage the monitor or the unit.

### Recommended cleaning method:

Gently wipe the panel with a soft, dry cloth.

### ❑ Moisture condensation

Moisture may condense on the lens inside the unit in the following cases:

- After starting the heater in the car.
- If it becomes very humid inside the car.

Should this occur, the unit may malfunction. In this case, eject the disc and leave the unit turned on for a few hours until the moisture evaporates.

### ❑ How to handle discs

- When removing a disc from its case, press down the center holder of the case and lift the disc out, holding it by the edges.



- Always hold the disc by the edges. Do not touch its recording surface.
- When storing a disc in its case, gently insert the disc around the center holder (with the printed surface facing up).
  - Make sure to store discs in their cases after use.

### ❑ To keep discs clean

Dirty discs may not play correctly.

If a disc does become dirty, wipe it with a soft cloth in a straight line from the center to the edge.



- Do not use any solvents (for example, conventional record cleaner, spray, thinner, benzine, etc.) to clean discs.

### ❑ To play new discs

New discs may have some rough spots around the inner and outer edges. If such a disc is used, this unit may reject the disc.



- To remove these rough spots, rub the edges with a pencil or ball-point pen, etc.

## More information

### ❑ File playback

#### Playing DivX files

- This unit can play back DivX files with the extension code <.divx>, <.div>, or <.avi> (regardless of the letter case—upper/lower).
- Audio streams should conform to MP3 or Dolby Digital.
- Files encoded in the interlaced scanning mode may not be played back correctly.
- The maximum bit rate for video signals (average) is 8 Mbps.

#### Playing MPEG1/MPEG2 files

- This unit can play back MPEG1/MPEG2 files with the extension code <.mpg> or <.mpeg>.
- The stream format should conform to MPEG system/program stream.  
The file format should be MP@ML (Main Profile at Main Level)/SP@ML (Simple Profile at Main Level)/MP@LL (Main Profile at Low Level).
- Audio streams should conform to MPEG1 Audio Layer-2 or Dolby Digital.

#### Playing JPEG files

- This unit can play back picture files with the extension code <.jpg> or <.jpeg>.
- This unit can play back files that are at 32 x 32 to 8 192 x 7 680 resolution.  
It may take time to display the file depending on its resolution.
- This unit can play back baseline JPEG files. Progressive JPEG files or lossless JPEG files cannot be played.



## REFERENCES

### Playing audio files (MP3/WMA/WAV/AAC/FLAC)

- This unit can play back files with the extension code:
  - For disc: <.mp3>, <.wma>, <.wav>, <.m4a>
  - For USB mass storage class device: <.mp3>, <.wma>, <.wav>, <.aac>, <.m4a>, <.flac>
- This unit can play back files that meet the conditions below:
  - Bit rate:
    - MP3: 8 kbps – 320 kbps
    - WMA : For disc : 5 kbps – 320 kbps
    - For USB : 32 kbps – 192 kbps
  - AAC: 16 kbps – 320 kbps
  - Sampling frequency:
    - MP3/WMA: 8 kHz – 48 kHz
    - WAV: 44.1 kHz
    - AAC: 32 kHz – 48 kHz
    - FLAC: 8 kHz – 48 kHz
- This unit can show ID3 Tag Version 1.0/1.1/2.2/3/2.4 (for MP3).
- This unit can also show WMA/WAV/AAC/FLAC Tag.
- This unit can play back files recorded in VBR (variable bit rate).
- Files recorded in VBR have a discrepancy in elapsed time indication.
- This unit cannot play back the following files:
  - MP3 files encoded with MP3i and MP3 PRO format.
  - MP3 files encoded with Layer 1/2.
  - WMA files encoded with lossless, professional, and voice format.
  - WMA files which are not based upon Windows Media® Audio.
  - WMA/AAC files copy-protected with DRM.
  - AAC files copy-protected with FairPlay (except those stored on an iPod/iPhone).
  - Files which have data such as AIFF, ATRAC3, etc.

- This unit can display jacket pictures that meet the conditions below:
  - Picture size: 32 x 32 to 1 232 x 672 resolution
  - Data size: less than 500 KB
  - File type: JPEG

### Disc playback

#### Playable disc types

Disc type	Recording format, file type, etc.
<b>DVD</b> <ul style="list-style-type: none"> <li>DTS sound cannot be reproduced or emitted from this unit.</li> </ul>	DVD Video*1
<b>DVD Recordable/Rewritable (DVD-R/-RW*2, +R/+RW*3)</b> <ul style="list-style-type: none"> <li>DVD Video: UDF bridge</li> <li>DivX/MPEG1/MPEG2/MP3/WMA/WAV/AAC: ISO 9660 level 1, level 2, Romeo, Joliet</li> </ul>	<ul style="list-style-type: none"> <li>DVD Video</li> <li>DivX/MPEG1/MPEG2/JPEG</li> <li>MP3/WMA/WAV/AAC (.m4a)</li> </ul>
<b>Dual Disc</b>	DVD side
<b>CD/VCD</b>	<ul style="list-style-type: none"> <li>VCD (Video CD)</li> <li>Audio CD/CD Text (CD-DA)</li> </ul>
<b>CD Recordable/Rewritable (CD-R/-RW)</b> <ul style="list-style-type: none"> <li>ISO 9660 level 1, level 2, Romeo, Joliet</li> </ul>	<ul style="list-style-type: none"> <li>VCD (Video CD)</li> <li>CD-DA</li> <li>DivX/MPEG1/MPEG2/JPEG</li> <li>MP3/WMA/WAV/AAC (.m4a)</li> </ul>

\*1 DVD Region code:

For DDX4017DAB/DDX4017BT/DDX317BT: 2

For DDX4017BTR: 5

If you insert a DVD Video disc of an incorrect Region Code, "Region Code Error" appears on the screen.

\*2 DVD-R recorded in multi-border format are also playable (except for dual layer discs). DVD-RW dual layer discs are not playable.

\*3 It is possible to play back finalized +R/+RW (Video format only) discs. "DVD" is selected as the disc type when a +R/+RW disc is loaded. +RW double layer discs are not playable.

#### Unplayable discs

- Unplayable disc types and formats are as follows:
  - DVD-Audio/DVD-ROM discs
  - MPEG4/AAC (.aac)/FLAC/MKV/DVD-VR/DVD+VR/DVD-RAM recorded on DVD-R/RW or +R/+RW
  - SVCD (Super Video CD), CD-ROM, CD-I (CD-I Ready), DTS-CD
  - MPEG4/AAC (.aac)/FLAC/MKV recorded on CD-R/RW
- Discs that are not round.
- Discs with coloring on the recording surface or discs that are dirty.
- Recordable/Rewritable discs that have not been finalized.
- 8 cm discs. Attempting to insert these discs using an adapter may cause a malfunction.

#### DualDisc playback

The Non-DVD side of a "DualDisc" does not comply with the "Compact Disc Digital Audio" standard. Therefore, the use of the Non-DVD side of a DualDisc on this product cannot be recommended.

Continued on the next page...

## REFERENCES

### Playing Recordable/Rewritable discs

- This unit can recognize a total of 5 000 files and 250 folders (a maximum of 999 files per folder).
- Use only “finalized” discs.
- This unit can play back multi-session discs; however, unclosed sessions will be skipped while playing.
- Some discs or files may not be played back due to their characteristics or recording conditions.

### ❑ About data stored in the connected USB device/iPod/iPhone/Android

- We bear no responsibility for any loss of data in iPod/iPhone, Android, and USB mass storage class devices while using this unit.

### ❑ USB playback

#### Playable files on a USB device

- This unit can play the following types of files stored in a USB mass storage class device.
  - JPEG/Divx/MPEG1/MPEG2/MP3/WMA/WAV/AAC (.aac/.m4a)/FLAC
- This unit can recognize:
  - A total of 5 000 files
  - 250 folders for video files and a maximum of 999 files per folder
  - 250 folders for photo files and a maximum of 999 files per folder
  - 999 folders for audio files and a maximum of 999 files per folder
- Make sure all important data has been backed up to avoid losing the data.

### Notes on using a USB device:

- This unit may not play back files in a USB device properly when using a USB extension cable.
- USB devices equipped with special functions such as data security functions cannot be used with the unit.
- Do not use a USB device with 2 or more partitions.
- Depending on the shape of the USB devices and connection ports, some USB devices may not be attached properly or the connection might be loose.
- This unit may not recognize a memory card inserted into a USB card reader.
- When connecting with a USB cable, use a USB 2.0 cable.
- The maximum number of characters (when the characters are 1 byte):
  - Folder names: 50 characters
  - File names: 50 characters
- Avoid using the USB device if it might affect driving safety.
- Do not pull out and connect the USB device repeatedly while “Reading” is shown on the screen.
- Electrostatic shock at connecting a USB device may cause abnormal playback of the device. In this case, disconnect the USB device then reset this unit and the USB device.
- Operation and power supply may not work as intended for some USB devices.
- Do not leave a USB device in the car, or expose to direct sunlight or high temperatures to prevent deformation or damage to the device.

### ❑ Notes on playing iPod/iPhone

- iPod/iPhone that can be connected to this unit:
  - Via the USB terminal:
    - Made for
      - iPod nano (7th Generation)\*<sup>1</sup>
      - iPod touch (6th Generation)\*<sup>1</sup>
      - iPod touch (5th Generation)\*<sup>1</sup>
      - iPhone SE\*<sup>1</sup>
      - iPhone 6S Plus\*<sup>1</sup>
      - iPhone 6S\*<sup>1</sup>
      - iPhone 6 Plus\*<sup>1</sup>
      - iPhone 6\*<sup>1</sup>
      - iPhone 5S\*<sup>1</sup>
      - iPhone 5C\*<sup>1</sup>
      - iPhone 5\*<sup>1</sup>
      - iPhone 4S
    - Via Bluetooth\*<sup>2</sup>:
      - Made for
        - iPod touch (6th Generation)
        - iPod touch (5th Generation)
        - iPhone SE
        - iPhone 6S Plus
        - iPhone 6S
        - iPhone 6 Plus
        - iPhone 6
        - iPhone 5S
        - iPhone 5C
        - iPhone 5
        - iPhone 4S

\*<sup>1</sup> You cannot watch video when connecting Lightning connector models.

\*<sup>2</sup> You cannot watch video when connecting via Bluetooth.

## REFERENCES

- When operating an iPod/iPhone, some operations may not be performed correctly or as intended. In this case, visit the following KENWOOD web site: <[www.kenwood.com/cs/ce/ipod](http://www.kenwood.com/cs/ce/ipod)>
- For some iPod/iPhone models, the performance may be abnormal or unstable during operation. In this case, disconnect the iPod/iPhone device, then check its condition.  
If the performance is not improved or slow, reset your iPod/iPhone.
- When you turn on this unit, the iPod/iPhone is charged through the unit.
- The text information may not be displayed correctly.

### Language codes (for DVD language selection)

AA	Afar	GL	Galician	MI	Maori	SO	Somali
AB	Abkhazian	GN	Guarani	MK	Macedonian	SQ	Albanian
AF	Afrikaans	GU	Gujarati	ML	Malayalam	SR	Serbian
AM	Ameharic	HA	Hausa	MN	Mongolian	SS	Siswati
AR	Arabic	HI	Hindi	MO	Moldavian	ST	Sesotho
AS	Assamese	HR	Croatian	MR	Marathi	SU	Sundanese
AY	Aymara	HU	Hungarian	MS	Malay (MAY)	SW	Swahili
AZ	Azerbaijani	HY	Armenian	MT	Maltese	TA	Tamil
BA	Bashkir	IA	Interlingua	MY	Burmese	TE	Telugu
BE	Byelorussian	IE	Interlingue	NA	Nauru	TG	Tajik
BG	Bulgarian	IK	Inupiak	NE	Nepali	TH	Thai
BH	Bihari	IN	Indonesian	NO	Norwegian	TI	Tigrinya
BI	Bislama	IS	Icelandic	OC	Occitan	TK	Turkmen
BN	Bengali, Bangla	IW	Hebrew	OM	(Afan) Oromo	TL	Tagalog
BO	Tibetan	JA	Japanese	OR	Oriya	TN	Setswana
BR	Breton	JL	Yiddish	PA	Panjabi	TO	Tonga
CA	Catalan	JW	Javanese	PL	Polish	TR	Turkish
CO	Corsican	KA	Georgian	PS	Pashto, Pushto	TS	Tsonga
CS	Czech	KK	Kazakh	QU	Quechua	TT	Tatar
CY	Welsh	KL	Greenlandic	RM	Rhaeto-Romance	TW	Twi
DZ	Bhutani	KM	Cambodian	RN	Kirundi	UK	Ukrainian
EL	Greek	KN	Kannada	RO	Rumanian	UR	Urdu
EO	Esperanto	KO	Korean (KOR)	RW	Kinyarwanda	UZ	Uzbek
ET	Estonian	KS	Kashmiri	SA	Sanskrit	VI	Vietnamese
EU	Basque	KU	Kurdish	SD	Sindhi	VO	Volapuk
FA	Persian	KY	Kirghiz	SG	Sangho	WO	Wolof
FI	Finnish	LA	Latin	SH	Serbo-Croatian	XH	Xhosa
FJ	Fiji	LN	Lingala	SI	Singhalese	YO	Yoruba
FO	Faroese	LO	Laothian	SK	Slovak	ZU	Zulu
FY	Frisian	LT	Lithuanian	SL	Slovenian		
GA	Irish	LV	Latvian, Lettish	SM	Samoan		
GD	Scots Gaelic	MG	Malagasy	SN	Shona		

## REFERENCES

### Error message list

If an error occurs while using the unit, a message appears. Take appropriate action according to the following message/remedy/cause list.

#### “No Signal”/“No Video Signal”:

- Start playback on the external component connected to the iPod/AV-IN input terminal.
- Check the cords and connections.
- Signal input is too weak.

#### “Miswiring DC Offset Error”/“Warning DC Offset Error”:

- A speaker cord has shorted or it has come into contact with the car chassis. Wire or insulate the speaker cord as appropriate, then reset the unit. (Pages 3 and 64)

#### “Parking off”:

- No playback picture is shown when the parking brake is not engaged.

#### “Authorization Error”:

- Check whether the connected iPod/iPhone is compatible with this unit. (Page 70)

#### “USB Device Error”:

- The USB power voltage is abnormal.
- Turn off and turn on the unit.
- Connect another USB device.

#### “Connection Error”:

- The device is registered but the connection has failed. Connect the registered device. (Page 40)

#### “Please Wait...”:

- The unit is preparing to use the Bluetooth function. If the message does not disappear, turn off and turn on the unit, then connect the device again (or reset the unit).

#### “No Voice Device”:

- The connected mobile phone does not have a voice recognition system.

#### “No Data”:

- No phone book data is contained in the connected Bluetooth phone.

#### “Initialize Error”:

- The unit has failed to initialize the Bluetooth module. Try the operation again.

#### “Dial Error”:

- Dialing has failed. Try the operation again.

#### “Hung Up Error”:

- The call has not ended yet. Park your car, and use the connected mobile phone to end the call.

#### “Pick Up Error”:

- The unit has failed to receive a call.

#### “Antenna Error”:

- The aerial has a short-circuit and the protective circuit has activated.
- Check the Digital Radio aerial. If a passive aerial without a booster is used, set aerial power to “OFF”.

### Troubleshooting

What appears to be trouble is not always serious. Check the following points before calling a service center.

- For operations with the external components, refer also to the instructions supplied with the adapters used for the connections (as well as the instructions supplied with the external components).

#### □ General

##### No sound comes out of the speakers.

- Adjust the volume to the optimum level.
- Check the cords and connections.

##### No picture is displayed on the screen.

- Turn on the screen. (Page 8)

##### The unit does not work at all.

- Reset the unit. (Page 3)

##### The remote controller\* does not work.

- Replace the battery.

\* Purchase KNA-RCDV331 separately.

## REFERENCES

### ❑ Discs

#### **Recordable/Rewritable discs cannot be played back.**

- Insert a finalized disc.
- Finalize the discs with the component which you used for recording.

#### **Tracks on the Recordable/Rewritable discs cannot be skipped.**

- Insert a finalized disc.
- Finalize the discs with the component which you used for recording.

#### **Playback does not start.**

- The format of files is not supported by the unit.

#### **No picture appears on the external monitor.**

- Connect the video cord correctly.
- Select the correct input on the external monitor.

#### **DivX/MPEG1/MPEG2/MP3/WMA/WAV/AAC discs cannot be played back.**

- Record the tracks using a compatible application on the appropriate discs. (Page 69)
- Add appropriate extension codes to the file names.

#### **Tracks on the Recordable/Rewritable discs are not played back as you have intended them to play.**

- Playback order may differ from the one played back using other players.

### ❑ USB

#### **“Reading” does not disappear from the screen.**

- Turn the power off and on again.

#### **While playing a track, sound is sometimes interrupted.**

- The tracks are not properly copied into the USB device. Copy the tracks again, and try again.

#### **Tracks are not played back as you have intended them to play.**

- Playback order may differ from the one played back using other players.

### ❑ Android

#### **Sound cannot be heard during playback.**

- Reconnect the Android device.
- When <Android Setup> is set to [HAND MODE], launch any media player application on the Android device and start playback.

#### **Sound output only from the Android device.**

- When <Android Setup> is set to [HAND MODE], relaunch the current media player application or use another media player application.
- Restart the Android device.
- If this does not solve the problem, the connected Android device is unable to route the audio signal to unit.

#### **Cannot playback when <Android Setup> is set to [BROWSE MODE].**

- Make sure KENWOOD Music Play APP is installed on the Android device.
- Reconnect the Android device and select the appropriate control mode.
- If this does not solve the problem, the connected Android device does not support the Browse Mode.

#### **“NO DEVICE” or “READING” keeps flashing.**

- Switch off the developer options on the Android device.
- Reconnect the Android device.
- If this does not solve the problem, the connected Android device does not support the Browse Mode.

### ❑ iPod/iPhone

#### **No sound comes out of the speakers.**

- Disconnect the iPod/iPhone, then connect it again.
- Select another source, then reselect “iPod”.

#### **The iPod/iPhone does not turn on or does not work.**

- Check the connecting cable and its connection.
- Update the firmware version.
- Charge the battery.
- Reset the iPod/iPhone.

#### **Sound is distorted.**

- Deactivate the equalizer either on this unit or the iPod/iPhone.

#### **A lot of noise is generated.**

- Turn off (uncheck) “VoiceOver” on the iPod/iPhone. For details, visit <<http://www.apple.com>>.

#### **No operations are available when playing back a track containing artwork.**

- Operate the unit after the artwork has loaded.

#### **Videos cannot be played.**

- Connect with USB Audio and Video cable KCA-iP202 (optional accessory) to iPod/iPhone 30-pin connector model. Other cables cannot be used.
- Select [USB + AV-IN] for <iPod Setup>. (Page 21)

## REFERENCES

### No sound of videos comes out.

- Connect with USB Audio and Video cable KCA-iP202 (optional accessory) to iPod/iPhone 30-pin connector model. Other cables cannot be used.
- Select **[USB+AV-IN]** for **<iPod Setup>**. (Page 21)

### ❑ Radio

#### AME automatic presetting does not work.

- Store stations manually. (Page 28)

#### Static noise while listening to the radio.

- Connect the aerial firmly.

### ❑ Digital Radio (DAB) (only for DDX4017DAB)

#### Cannot receive an ensemble.

- Your area is not covered by the ensemble.

#### The DAB aerial is not properly extended or positioned.

- Adjust the aerial and try the ensemble scanning again.
- Connect an active aerial (not supplied).

### ❑ AV-IN

#### “AV-IN” cannot be selected on the Home screen.

- Select connection method other than **[USB + AV-IN]** for **<iPod Setup>**. (Page 21)

#### No picture appears on the screen.

- Turn on the video component if it is not on.

### ❑ Spotify

#### The application does not work.

- The connected device is not compatible with the Spotify source.
- The application on your iPod touch/iPhone/Android is not the latest version. Update the application.

### ❑ Bluetooth

#### Phone sound quality is poor.

- Reduce the distance between the unit and the Bluetooth mobile phone.
- Move the car to a place where you can get a better signal reception.

#### The sound is interrupted or skipped while using a Bluetooth audio player.

- Reduce the distance between the unit and the Bluetooth audio player.
- Disconnect the device connected for Bluetooth phone.
- Turn off, then turn on the unit. (When the sound is not yet restored) connect the player again.

#### The connected audio player cannot be controlled.

- Check whether the connected audio player supports AVRCP (Audio/Video Remote Control Profile).

#### The Bluetooth device does not detect the unit.

- Search from the Bluetooth device again.

#### The unit does not pair with the Bluetooth device.

- For devices compatible with Bluetooth 2.1: Register the device using a PIN code. (Page 39)
- For devices compatible with Bluetooth 2.0: Enter the same PIN code for both the unit and target device. If the PIN code of the device is not indicated in its instructions, try “0000” or “1234.”
- Turn off, then turn on the Bluetooth device.

#### Echo or noise occurs.

- Adjust the microphone unit position.
- Adjust the echo volume or noise reduction volume. (Page 41)

#### The unit does not respond when you try to copy the phone book to the unit.

- You may have tried to copy the same entries (as stored) to the unit.

## Specifications

### ❑ Monitor section

Picture Size (W x H)	6.2 inches (diagonal) wide 137.5 mm × 77.2 mm
Display System	Transparent TN LCD panel
Drive System	TFT active matrix system
Number of Pixels	1 152 000 (800H × 480V × RGB)
Effective Pixels	99.99%
Pixel Arrangement	RGB striped arrangement
Back Lighting	LED

## REFERENCES

### ❑ DVD player section

D/A Converter	24 bit
Audio Decoder	Linear PCM/Dolby Digital/MP3/WMA/WAV/AAC (.m4a)
Video Decoder	DivX/MPEG1/MPEG2/JPEG
Wow & Flutter	Below Measurable Limit
Frequency Response	
96 kHz Sampling:	20 Hz to 22 000 Hz
48 kHz Sampling:	20 Hz to 22 000 Hz
44.1 kHz Sampling:	20 Hz to 20 000 Hz
Total Harmonic Distortion	
	0.010% (1 kHz)
Signal to Noise Ratio	
	99 dB (DVD-Video 96 kHz)
Dynamic Range	99 dB (DVD-Video 96 kHz)
Disc Format	DVD-Video/VIDEO-CD/CD-DA
Sampling Frequency	
	44.1 kHz/48 kHz/96 kHz
Quantifying Bit Number	
	16/20/24 bit

### ❑ USB interface section

USB Standard	USB 2.0 Full Speed/High Speed
Compatible Devices	Mass Storage Class
File System	FAT 16/32
Maximum Power Supply Current	DC 5 V $\bar{=}$ 1.5 A
D/A Converter	24 bit
Audio Decoder	MP3/WMA/AAC (.aac/.m4a)/WAV/FLAC
Video Decoder	DivX/MPEG1/MPEG2/JPEG

### ❑ Bluetooth section

Technology	Bluetooth 3.0
Frequency	2.402 GHz to 2.480 GHz
Output Power	+4 dBm (MAX), 0 dBm (AVE), Power Class 2
Maximum Communication Range	Line of sight approx. 10 m
Audio Codec	SBC/AAC
Profile	HFP (Hands Free Profile) 1.6 A2DP (Advanced Audio Distribution Profile) 1.3 AVRCP (Audio/Video Remote Control Profile) 1.5 GAP (Generic Access Profile) PBAP (PhoneBook Access Profile) 1.2 SDP (Service Discovery Profile) SPP (Serial Port Profile) 1.2

### ❑ DSP section

Equalizer	
BAND	13 Band
Frequency (Hz) (BAND1-13)	62.5/100/160/250/400/630/1k/1.6k/2.5k/4k/6.3k/10k/16k
Gain	-9/-8/-7/-6/-5/-4/-3/-2/-1/0/1/2/3/4/5/6/7/8/9 dB
Q factor	1.35/1.5/2.0
2 Way X'Over	
Tweeter:	
Frequency (Hz)	1k/1.6k/2.5k/4k/5k/6.3k/8k/10k/12.5k
Gain	-8/-7/-6/-5/-4/-3/-2/-1/0 dB
Front/Rear (HPF):	
Frequency (Hz)	Through/30/40/50/60/70/80/90/100/120/150/180/220/250
Slope	-6/-12/-18/-24 dB/Oct.
Gain	-8/-7/-6/-5/-4/-3/-2/-1/0 dB
Subwoofer (LPF):	
Frequency (Hz)	30/40/50/60/70/80/90/100/120/150/180/220/250/Through
Slope	-6/-12/-18/-24 dB/Oct.
Phase	Normal/Reverse
Gain	-8/-7/-6/-5/-4/-3/-2/-1/0 dB

## REFERENCES

### 3 Way X'Over

#### Tweeter (HPF):

Frequency (Hz) 1k/1.6k/2.5k/4k/5k/6.3k/8k/10k/  
12.5k

Slope -6/-12 dB/Oct.

Phase Normal/Reverse

Gain -8/-7/-6/-5/-4/-3/-2/-1/0 dB

#### Mid Range (HPF):

Frequency (Hz) Through/30/40/50/60/70/80/90/  
100/120/150/180/220/250

Slope -6/-12 dB/Oct.

#### Mid Range (LPF):

Frequency (Hz) 1k/1.6k/2.5k/4k/5k/6.3k/8k/10k/  
12.5k/Through

Slope -6/-12 dB/Oct.

Phase Normal/Reverse

Gain -8/-7/-6/-5/-4/-3/-2/-1/0 dB

#### Subwoofer (LPF):

Frequency (Hz) 30/40/50/60/70/80/90/  
100/120/150/180/220/250/  
Through

Slope -6/-12 dB/Oct.

Phase Normal/Reverse

Gain -8/-7/-6/-5/-4/-3/-2/-1/0 dB

#### Position

Front/Rear/Subwoofer Delay (for 2 Way X'over)/  
Tweeter/Mid Range/Subwoofer Delay (for 3 Way  
X'over) 0 cm to 610 cm (2.0 cm Step)

Gain -8 dB to 0 dB

Subwoofer Level -50 dB to +10 dB

### FM radio section

Frequency Range (50 kHz)  
87.5 MHz to 108.0 MHz

Usable Sensitivity (S/N: 26 dB)  
6.2 dBf (0.56  $\mu$ V/75  $\Omega$ )

Quieting Sensitivity (S/N: 46 dB)  
15.2 dBf (1.58  $\mu$ V/75  $\Omega$ )

Frequency Response ( $\pm$ 3.0 dB)  
30 Hz to 15 kHz

Signal to Noise Ratio  
68 dB (MONO)

Selectivity ( $\pm$ 400 kHz)  
 $\geq$  80 dB

Stereo Separation 40 dB (1 kHz)

### LW tuner section

Frequency Range (9 kHz)  
153 kHz to 279 kHz

Usable Sensitivity 45  $\mu$ V

### MW tuner section

Frequency Range (9 kHz)  
531 kHz to 1 611 kHz

Usable Sensitivity 28.5  $\mu$ V

### Digital tuner (DAB) section (DDX4017DAB)

Frequency Range  
L-BAND: 1 452.960 MHz to 1 490.624 MHz  
BAND III: 174.928 MHz to 239.200 MHz

Sensitivity -100 dBm

Signal to Noise Ratio  
90 dB

#### DAB Aerial Connector

Connector type: SMB

Output Voltage: 14.4 V (11 V to 16 V allowable)

Maximum Current: < 100 mA



## REFERENCES

### ❑ Video section

Color System of External Video Input  
NTSC/PAL

External Video Input Level (mini jack)  
1 Vp-p/75 Ω

External Audio Max Input Level (mini jack)  
2 V/25 kΩ

Video Input Level (RCA jack)  
1 Vp-p/75 Ω

Video Output Level (RCA jack)  
1 Vp-p/75 Ω

Analog RGB Input 0.7 Vp-p/75 Ω\*

\* Only for DDX4017DAB/DDX4017BT.

### ❑ Audio section

Maximum Power (Front & Rear)  
50 W × 4

Full Bandwidth Power (Front & Rear)  
22 W × 4 (at less than 1%THD)

Preout Level  
For DDX4017DAB/DDX4017BT/DDX4017BTR:  
4 V/10 kΩ

For DDX317BT: 2.5 V/10 kΩ

Preout Impedance  
≤ 600 Ω

Speaker Impedance  
4 Ω to 8 Ω

### ❑ General

Operating Voltage  
14.4 V (10.5 V to 16 V allowable)

Maximum Current Consumption  
10 A

Installation Dimensions (W × H × D)  
182 mm × 111 mm × 162 mm

Operational Temperature Range  
−10°C to +60°C

Weight  
2.0 kg (Trim plate and sleeve are included.)

Design and specifications are subject to change without notice.

### ❑ Trademarks and licenses

- Dolby, Dolby Audio and the double-D symbol are trademarks of Dolby Laboratories.
- “DVD Logo” is a trademark of DVD Format/Logo Licensing Corporation registered in the US, Japan and other countries.
- The “AAC” logo is a trademark of Dolby Laboratories.
- Microsoft and Windows Media are either registered trademarks or trademarks of Microsoft Corporation in the United States and/or other countries.
- “Made for iPod,” and “Made for iPhone” mean that an electronic accessory has been designed to connect specifically to iPod, or iPhone, respectively, and has been certified by the developer to meet Apple performance standards. Apple is not responsible for the operation of this device or its compliance with safety and regulatory standards. Please note that the use of this accessory with iPod, or iPhone may affect wireless performance. iPhone, iPod, iPod classic, iPod nano, and iPod touch are trademarks of Apple Inc., registered in the U.S. and other countries.
- Lightning is a trademark of Apple Inc.
- This item incorporates copy protection technology that is protected by U.S. patents and other intellectual property rights of Rovi Corporation. Reverse engineering and disassembly are prohibited.
- Font for this product is designed by Ricoh.

## REFERENCES

- THIS PRODUCT IS LICENSED UNDER THE AVC PATENT PORTFOLIO LICENSE FOR THE PERSONAL USE OF A CONSUMER OR OTHER USES IN WHICH IT DOES NOT RECEIVE REMUNERATION TO (i) ENCODE VIDEO IN COMPLIANCE WITH THE AVC STANDARD ("AVC VIDEO") AND/OR (ii) DECODE AVC VIDEO THAT WAS ENCODED BY A CONSUMER ENGAGED IN A PERSONAL ACTIVITY AND/OR WAS OBTAINED FROM A VIDEO PROVIDER LICENSED TO PROVIDE AVC VIDEO. NO LICENSE IS GRANTED OR SHALL BE IMPLIED FOR ANY OTHER USE. ADDITIONAL INFORMATION MAY BE OBTAINED FROM MPEG LA, L.L.C. SEE [HTTP://WWW.MPEGLA.COM](http://www.mpegla.com)
- Android is a trademark of Google Inc.
- The Bluetooth® word mark and logos are registered trademarks owned by Bluetooth SIG, Inc. and any use of such marks by JVC KENWOOD Corporation is under license. Other trademarks and trade names are those of their respective owners.
- SPOTIFY and the Spotify logo are among the registered trademarks of Spotify AB.
- libFLAC  
Copyright (C) 2000,2001,2002,2003,2004,2005, 2006,2007,2008,2009 Josh Coalson  
Redistribution and use in source and binary forms, with or without modification, are permitted provided that the following conditions are met:
  - Redistributions of source code must retain the above copyright notice, this list of conditions and the following disclaimer.
  - Redistributions in binary form must reproduce the above copyright notice, this list of conditions and the following disclaimer in the documentation and/or other materials provided with the distribution.
  - Neither the name of the Xiph.org Foundation nor the names of its contributors may be used to endorse or promote products derived from this software without specific prior written permission.

THIS SOFTWARE IS PROVIDED BY THE COPYRIGHT HOLDERS AND CONTRIBUTORS "AS IS" AND ANY EXPRESS OR IMPLIED WARRANTIES, INCLUDING, BUT NOT LIMITED TO, THE IMPLIED WARRANTIES OF MERCHANTABILITY AND FITNESS FOR A PARTICULAR PURPOSE ARE DISCLAIMED. IN NO EVENT SHALL THE FOUNDATION OR CONTRIBUTORS BE LIABLE FOR ANY DIRECT, INDIRECT, INCIDENTAL, SPECIAL, EXEMPLARY, OR CONSEQUENTIAL DAMAGES (INCLUDING, BUT NOT LIMITED TO, PROCUREMENT OF SUBSTITUTE GOODS OR SERVICES; LOSS OF USE, DATA, OR PROFITS; OR BUSINESS INTERRUPTION) HOWEVER CAUSED AND ON ANY THEORY OF LIABILITY, WHETHER IN CONTRACT, STRICT LIABILITY, OR TORT (INCLUDING NEGLIGENCE OR OTHERWISE) ARISING IN ANY WAY OUT OF THE USE OF THIS SOFTWARE, EVEN IF ADVISED OF THE POSSIBILITY OF SUCH DAMAGE.

### **DIVX**

- This DivX Certified® device has passed rigorous testing to ensure it plays DivX® video. To play purchased DivX movies, first register your device at [vod.divx.com](http://vod.divx.com). Find your registration code in the DivX VOD section of your device setup menu. (Page 58)
- DivX Certified® to play DivX® video, including premium content.
- DivX®, DivX Certified® and associated logos are trademarks of DivX, LLC and are used under license.



**Declaration of Conformity with regard to the RE Directive 2014/53/EU**  
**Declaration of Conformity with regard to the RoHS Directive 2011/65/EU**

**Manufacturer:**

JVC KENWOOD Corporation  
3-12 Moriya-cho, Kanagawa-ku, Yokohama-shi, Kanagawa, 221-0022, Japan

**EU Representative:**

JVCKENWOOD NEDERLAND B.V.  
Amsterdamseweg 37, 1422 AC UITHOORN, The Netherlands

**English**

Hereby, JVCKENWOOD declares that the radio equipment "DDX4017DAB/DDX4017BT/DDX4017BTR/DDX317BT" is in compliance with Directive 2014/53/EU. The full text of the EU declaration of conformity is available at the following internet address:  
<http://www.kenwood.com/cs/ce/eudoc/>

**Français**

Par la présente, JVCKENWOOD déclare que l'équipement radio « DDX4017DAB/DDX4017BT/DDX4017BTR/DDX317BT » est conforme à la directive 2014/53/UE. L'intégralité de la déclaration de conformité UE est disponible à l'adresse Internet suivante :  
<http://www.kenwood.com/cs/ce/eudoc/>

**Deutsch**

Hiermit erklärt JVCKENWOOD, dass das Funkgerät "DDX4017DAB/DDX4017BT/DDX4017BTR/DDX317BT" der Richtlinie 2014/53/EU entspricht. Der volle Text der EU-Konformitätserklärung steht unter der folgenden Internetadresse zur Verfügung:  
<http://www.kenwood.com/cs/ce/eudoc/>

**Nederlands**

Hierbij verklaart JVCKENWOOD dat de radioapparaat "DDX4017DAB/DDX4017BT/DDX4017BTR/DDX317BT" in overeenstemming is met Richtlijn 2014/53/EU. De volledige tekst van de EU-verklaring van overeenstemming is te vinden op het volgende internetadres:  
<http://www.kenwood.com/cs/ce/eudoc/>

**Italiano**

Con la presente, JVCKENWOOD dichiara che l'apparecchio radio "DDX4017DAB/DDX4017BT/DDX4017BTR/DDX317BT" è conforme alla Direttiva 2014/53/UE. Il testo integrale della dichiarazione di conformità UE è disponibile al seguente indirizzo internet:  
<http://www.kenwood.com/cs/ce/eudoc/>

**Español**

Por la presente, JVCKENWOOD declara que el equipo de radio "DDX4017DAB/DDX4017BT/DDX4017BTR/DDX317BT" cumple la Directiva 2014/53/UE. El texto completo de la declaración de conformidad con la UE está disponible en la siguiente dirección de internet:  
<http://www.kenwood.com/cs/ce/eudoc/>

**Português**

Deste modo, a JVCKENWOOD declara que o equipamento de rádio "DDX4017DAB/DDX4017BT/DDX4017BTR/DDX317BT" está em conformidade com a Diretiva 2014/53/UE. O texto integral da declaração de conformidade da UE está disponível no seguinte endereço de internet:  
<http://www.kenwood.com/cs/ce/eudoc/>

**Polska**

Niniejszym, JVCKENWOOD deklaruje, że sprzęt radiowy "DDX4017DAB/DDX4017BT/DDX4017BTR/DDX317BT" jest zgodny z dyrektywą 2014/53/UE. Pełny tekst deklaracji zgodności EU jest dostępny pod adresem:  
<http://www.kenwood.com/cs/ce/eudoc/>

**Český**

Společnost JVCKENWOOD tímto prohlašuje, že rádiové zařízení "DDX4017DAB/DDX4017BT/DDX4017BTR/DDX317BT" splňuje podmínky směrnice 2014/53/EU. Plný text EU prohlášení o shodě je dostupný na následující internetové adrese:  
<http://www.kenwood.com/cs/ce/eudoc/>

**Magyar**

JVCKENWOOD ezennél kijelenti, hogy a „DDX4017DAB/DDX4017BT/DDX4017BTR/DDX317BT” rádióberendezés megfelel a 2014/53/EU irányelvnek. Az EU konformitási nyilatkozat teljes szövege az alábbi weboldalon érhető el:  
<http://www.kenwood.com/cs/ce/eudoc/>

**Svenska**

Härmed försäkras JVCKENWOOD att radiotröstningen "DDX4017DAB/DDX4017BT/DDX4017BTR/DDX317BT" är i enlighet med direktiv 2014/53/EU. Den fullständiga texten av EU-försäkran om överensstämmelse finns på följande Internetadress:  
<http://www.kenwood.com/cs/ce/eudoc/>

**Suomi**

JVCKENWOOD julistaa täten, että radiolaite "DDX4017DAB/DDX4017BT/DDX4017BTR/DDX317BT" on direktiivin 2014/53/EU mukainen. EU-vaatimustenmukaisuusvakuutusvaatim us löytyy kokonaisuudessaan seuraavasta internet-osoitteesta:  
<http://www.kenwood.com/cs/ce/eudoc/>

**Slovensko**

S tem JVCKENWOOD izjavlja, da je radijska oprema »DDX4017DAB/DDX4017BT/DDX4017BTR/DDX317BT« v skladu z Direktivo 2014/53/EU. Celotno besedilo direktive EU o skladnosti je dostopno na tem spletnem naslovu:  
<http://www.kenwood.com/cs/ce/eudoc/>

**Slovensky**

Spoločnosť JVCKENWOOD týmto vyhlasuje, že rádiové zariadenie „DDX4017DAB/DDX4017BT/DDX4017BTR/DDX317BT” vyhovuje smernici 2014/53/EU. Celý text EU vyhlásenia o zhode na nasledovnej internetovej adrese:  
<http://www.kenwood.com/cs/ce/eudoc/>

**Dansk**

Herved erklærer JVCKENWOOD, at radioudstyret "DDX4017DAB/DDX4017BT/DDX4017BTR/DDX317BT" er i overensstemmelse med Direktiv 2014/53/EU. EU-overensstemmelseserklæringens fulde ordly er tilgængelig på følgende internetadresse:  
<http://www.kenwood.com/cs/ce/eudoc/>

**Ελληνικά**

Με το παρόν, η JVCKENWOOD δηλώνει ότι ο ραδιοεξοπλισμός «DDX4017DAB/DDX4017BT/DDX4017BTR/DDX317BT» συμμορφώνεται με την Οδηγία 2014/53/ΕΕ. Το πλήρες κείμενο της δήλωσης συμμόρφωσης της ΕΕ είναι διαθέσιμο στην ακόλουθη διεύθυνση στο διαδίκτυο:  
<http://www.kenwood.com/cs/ce/eudoc/>

## Eesti

Käesolevaga JVCKENWOOD kinnitab, et „DDX4017DAB/DDX4017BT/DDX4017BTR/DDX317BT” raadiovarustus on vastavuses direktiiviga 2014/53/EL.

ELi vastavusdeklaratsiooni terviktekst on kättesaadav järgmisel internetiaadressil: <http://www.kenwood.com/cs/ce/eudoc/>

## Latviešu

JVCKENWOOD ar šo deklarē, ka radio aparatūra „DDX4017DAB/DDX4017BT/DDX4017BTR/DDX317BT” atbilst direktīvas 2014/53/ES prasībām.

Pilns ES atbilstības deklarācijas teksts ir pieejams šādā tīmekļa adresē: <http://www.kenwood.com/cs/ce/eudoc/>

## Lietuviškai

Šiuo JVCKENWOOD pažymi, kad radijo įranga „DDX4017DAB/DDX4017BT/DDX4017BTR/DDX317BT” atitinka 2014/53/EB direktyvos reikalavimus.

Visą EB direktyvos atitikties deklaracijos tekstą galite rasti šiuo internetiniu adresu: <http://www.kenwood.com/cs/ce/eudoc/>

## Malti

B'dan, JVCKENWOOD jiddikjara li t-tagħmir tar-radju “DDX4017DAB/DDX4017BT/DDX4017BTR/DDX317BT” huwa konformi mad-Direttiva 2014/53/UE.

It-test kollu tad-dikjarazzjoni ta' konformità huwa disponibbli fi-indirizz intranet li ġej: <http://www.kenwood.com/cs/ce/eudoc/>

## HRVATSKI / SRPSKI JEZIK

JVCKENWOOD ovim izjavljuje da je radio oprema “DDX4017DAB/DDX4017BT/DDX4017BTR/DDX317BT” u skladu s Direktivom 2014/53/EU.

Cjeloviti tekst deklaracije Europske unije o usklađenosti dostupan je na sljedećoj internet adresi:

<http://www.kenwood.com/cs/ce/eudoc/>

## ROMÂNĂ

Prin prezenta, JVCKENWOOD declară că echipamentul radio “DDX4017DAB/DDX4017BT/DDX4017BTR/DDX317BT” este în conformitate cu Directiva 2014/53/UE. Textul integral al declarației de conformitate UE este disponibil la următoarea adresă de internet:

<http://www.kenwood.com/cs/ce/eudoc/>

## БЪЛГАРСКИ

С настоящото JVCKENWOOD декларира, че радиооборудването на “DDX4017DAB/DDX4017BT/DDX4017BTR/DDX317BT” е в съответствие с Директива 2014/53/ЕС. Пълният текст на ЕС декларацията за съответствие е достъпен на следния интернет адрес:

<http://www.kenwood.com/cs/ce/eudoc/>

## Turkish

Burada, JVCKENWOOD “DDX4017DAB/DDX4017BT/DDX4017BTR/DDX317BT” radyo ekipmanının 2014/53/AB Direktifine uygun olduğunu bildirir.

AB uyumluluk deklarasyonunun tam metni aşağıdaki internet adresinde mevcuttur. <http://www.kenwood.com/cs/ce/eudoc/>

## Русский

JVCKENWOOD настоящим заявляет, что радиооборудование «DDX4017DAB/DDX4017BT/DDX4017BTR/DDX317BT» соответствует Директиве 2014/53/EU. Полный текст декларации соответствия ЕС доступен по следующему адресу в сети Интернет:

<http://www.kenwood.com/cs/ce/eudoc/>

## Українська

Таким чином, компанія JVCKENWOOD заявляє, що радіообладнання «DDX4017DAB/DDX4017BT/DDX4017BTR/DDX317BT» відповідає Директиві 2014/53/EU.

Повний текст декларації про відповідність ЄС можна знайти в Інтернеті за такою адресою:

<http://www.kenwood.com/cs/ce/eudoc/>