

## **DNX8160DABS DNX716WDABS DNX5160DABS DNX516DABS DNX5160BTS DNX3160BT**

---

### GPS NAVIGATION SYSTEM **INSTRUCTION MANUAL**

JVC KENWOOD Corporation

Before reading this manual, click the button below to check the latest edition and the modified pages.  
<http://manual.kenwood.com/edition/im391/>



# What Do You Want To Do?

Thank you for purchasing the KENWOOD GPS NAVIGATION SYSTEM.  
In this manual, you will learn various convenient functions of the system.

**Click the icon of the media you want to play.**  
With one-click, you can jump to the section of each media!

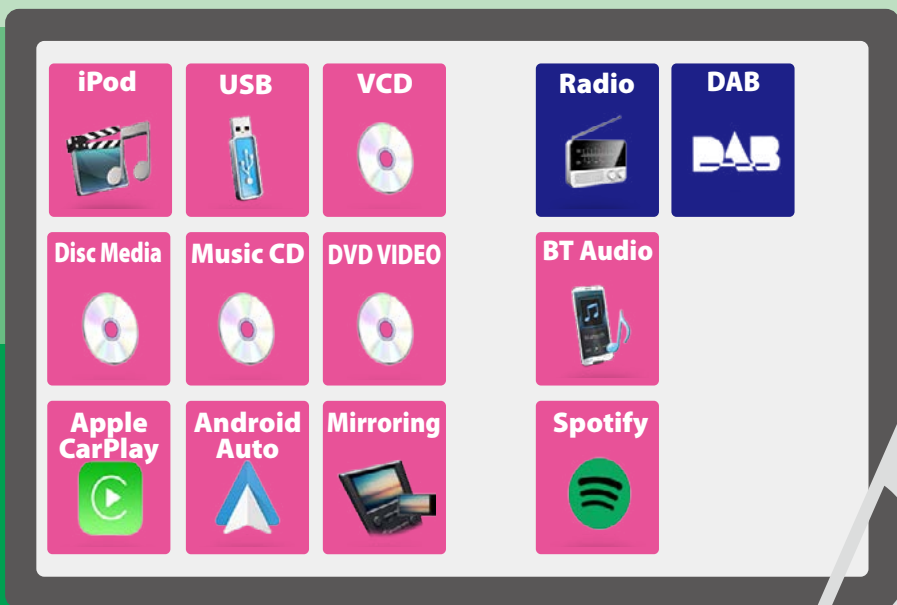

# Contents

<b>Before Use</b>	<b>4</b>	<b>Radio</b>	<b>52</b>
▲ WARNING _____	4	Radio Basic Operation _____	52
<b>How to Read this Manual</b>	<b>5</b>	Digital Radio Basic Operation _____	54
<b>Basic Operations</b>	<b>6</b>	Memory Operation _____	56
Functions of the Buttons on the Front Panel _____	6	Selecting Operation _____	57
Turning on the Unit _____	14	Traffic Information (FM Tuner and Digital Radio only) _____	58
How to Play Media _____	17	Replay (Digital Radio only) _____	59
Detaching The Front Panel _____	21	Radio Setup _____	60
Operating with the HOME Screen _____	22	Digital Radio Setup _____	61
Common Operations _____	24	<b>Bluetooth Control</b>	<b>64</b>
Navigation Operation _____	26	Registering and Connecting Bluetooth Unit _____	64
<b>DVD/Video CD (VCD)</b>	<b>28</b>	Playing Bluetooth Audio Device _____	68
DVD/VCD Basic Operation _____	28	Using Hands-Free Unit _____	70
DVD Disc Menu Operation _____	31	Hands-Free Setup _____	74
DVD Setup _____	32	<b>Setting Up</b>	<b>76</b>
<b>CD/Audio and Visual Files/iPod/ APPS</b>	<b>34</b>	Monitor Screen Setup _____	76
APP/iPod settings _____	35	Monitor Angle Control _____	77
Music/Video Basic Operation _____	36	View Camera Control _____	77
Search Operation _____	40	System Setup _____	78
Spotify Operation _____	44	User Interface Setup _____	78
Mirroring Operation _____	46	Special Setup _____	81
Apple CarPlay Operation _____	48	Security Setup _____	82
Android Auto™ Operation _____	50	Display Setup _____	83
		Camera Setup _____	85
		Navigation Setup _____	86
		AV Setup _____	87

<b>Controlling Audio</b>	<b>88</b>
Speaker/ X'over setup _____	88
Controlling General Audio _____	91
Equalizer Control _____	92
Volume Offset _____	93
Zone Control _____	94
Sound Effect _____	95
Listening Position/ DTA _____	96
<b>Remote control</b>	<b>100</b>
Battery Installation _____	100
Functions of the Remote control Buttons	101
<b>Troubleshooting</b>	<b>104</b>
Problems and Solutions _____	104
Error Messages _____	105
<b>Appendix</b>	<b>108</b>
Playable Media and Files _____	108
Status Bar Indicator Items _____	112
Region Codes in the World _____	114
DVD Language Codes _____	115
Specifications _____	116
About this Unit _____	119

## Before Use

### ⚠ WARNING

#### To prevent injury or fire, take the following precautions:

- To prevent a short circuit, never put or leave any metallic objects (such as coins or metal tools) inside the unit.
- Do not watch or fix your eyes on the unit's display when you are driving for any extended period.
- If you experience problems during installation, consult your KENWOOD dealer.

#### Precautions on using this unit

- When you purchase optional accessories, check with your KENWOOD dealer to make sure that they work with your model and in your area.
- You can select language to display menus, audio file tags, etc. See [User Interface Setup \(P.78\)](#).
- The Radio Data System or Radio Broadcast Data System feature won't work where the service is not supported by any broadcasting station.

#### Protecting the monitor

To protect the monitor from damage, do not operate the monitor using a ball point pen or similar tool with the sharp tip.

#### Cleaning the unit

If the faceplate of this unit is stained, wipe it with a dry soft cloth such as a silicon cloth. If the faceplate is stained badly, wipe the stain off with a cloth moistened with neutral cleaner, then wipe it again with a clean soft dry cloth.



- Applying spray cleaner directly to the unit may affect its mechanical parts. Wiping the faceplate with a hard cloth or using a volatile liquid such as thinner or alcohol may scratch the surface or erase screened print.

#### Lens fogging

When you turn on the car heater in cold weather, dew or condensation may form on the lens in the disc player of the unit. Called lens fogging, this condensation on the lens may not allow discs to play. In such a situation, remove the disc and wait for the condensation to evaporate. If the unit still does not operate normally after a while, consult your KENWOOD dealer.

#### Precautions on handling discs

- Do not touch the recording surface of the disc.
- Do not stick tape etc. on the disc, or use a disc with tape stuck on it.
- Do not use disc type accessories.
- Clean from the center of the disc and move outward.
- When removing discs from this unit, pull them out horizontally.
- If the disc center hole or outside rim has burrs, use the disc only after removing the burrs with a ballpoint pen etc.
- Discs that are not round cannot be used.

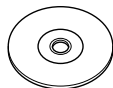

- 8-cm (3 inch) discs cannot be used.
- Discs with coloring on the recording surface or discs that are dirty cannot be used.
- This unit can only play the CDs with



This unit may not correctly play discs which do not have the mark.

- You cannot play a disc that has not been finalized. (For the finalization process see your writing software, and your recorder instruction manual.)

# How to Read this Manual

CD/Audio and Visual Files/iPod/APPS

## Search Operation

You can search music or video files by the following operations.

### NOTE

- If you use a remote control, you can jump directly to the desired track/file with entering the track/folder/file number, play time, etc. For details, see [Direct search mode \(P.101\)](#).

## List search

You can search tracks, folders, and files according to hierarchy.

### 1 Touch [Q].

Category List screen appears.

### 2 Touch [▼].

### 3 Touch [Category List].

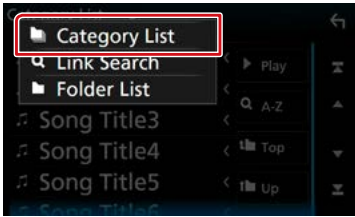

### 4 Select whether you search by audio files or video files .

### 5 Touch the desired category.

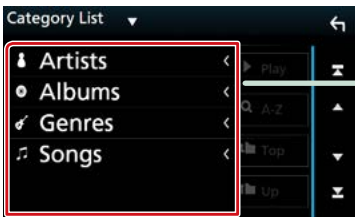

### 6 The list is sorted by selected category.

### 7 Touch desired item.

Playback starts.

### Operation title

Introduces the function.

### NOTE

Introduces some tips, notes, etc.

### Reference mark

Displayed in blue notes.

With one-click, you can jump to the article related to the current section.

### Operation procedure

Explains necessary procedures to achieve the operation.

< >: Indicates the name of panel buttons.

[ ]: Indicates the name of touch keys.

### Screen shot

Shows some screen shots displayed during operation for reference.

The area or keys to touch are surrounded with a red frame.

### NOTE

- The screens and panels shown in this manual are examples used to provide clear explanations of the operations. For this reason, they may be different from the actual screens or panels used, or some display patterns may be different.

# Basic Operations

## Functions of the Buttons on the Front Panel

### DNX8160DABS

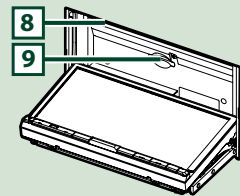
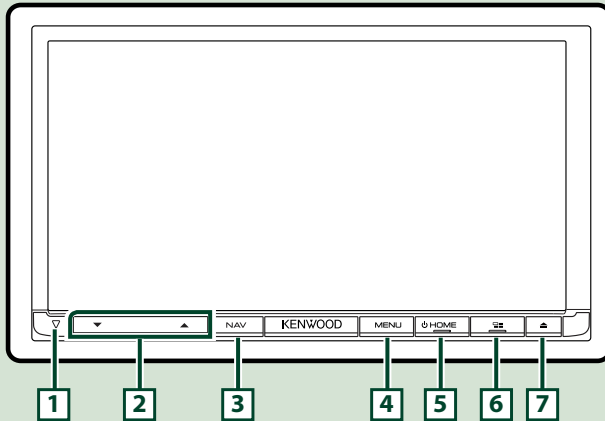

#### NOTE

- The panels shown in this guide are examples used to provide clear explanations of the operations. For this reason, they may be different from the actual panels.
- In this manual, each model name is abbreviated as follows.  
DNX8160DABS: **DNX8**  
If above icon is showed, read the article applicable to the unit you use.



## How to insert an SD Card

- 1) Press **7** <▲> button.
- 2) Touch [OPEN] to the panel fully opens.
- 3) Hold the SD card as the illustration in the right and insert it into the slot until it clicks.
- 4) Press **7** <▲> button.

#### ● To eject the card:

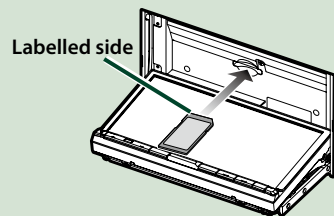
- 1) Press **7** <▲> button.
- 2) Touch [OPEN].
- 3) Push the card until it clicks and then remove your finger from the card. The card pops up so that you can pull it out with your fingers.
- 4) Press **7** <▲> button.



Number	Name	Motion
1	▽	• This indicator flashes when the vehicle ignition is off <a href="#">(P.82)</a> .
2	▼, ▲ (Volume)	• Adjusts volume. The volume will go up until 15 when you keep pressing [ ▲ ].
3	NAV	• Displays the navigation screen.
4	MENU	• Displays the popup menu screen. • Pressing for 1 second turns the screen off.
5	HOME	• Displays the HOME screen <a href="#">(P.22)</a> . • Pressing for 1 second turns the power off. • When the power off, turns the power on.
6		• Displays the APP (CarPlay/ Android Auto/ Mirroring) screen. • Pressing for 1 second displays the Voice Recognition screen. <a href="#">(P.73)</a>
7		• Displays the Angle Adjust screen. – [DISC EJECT]: Ejects the disc. – [OPEN]: Fully opens the panel to the location of the SD card slot. • When the panel is opened, pressing closes the panel. • To forcibly eject the disc, press it for 2 seconds and touch [DISC EJECT] after the message is displayed.
8	Disc insert slot	• A slot to insert a disc media.
9	SD card slot	• A slot to insert an SD card. • You can play audio/visual file in the card. * • An SD card slot for upgrading the map. For how to upgrade the map, refer to the instruction manual of the navigation system.

\* If the map update file remains in the SD card, you cannot play audio/visual file.



## DNX716WDABS

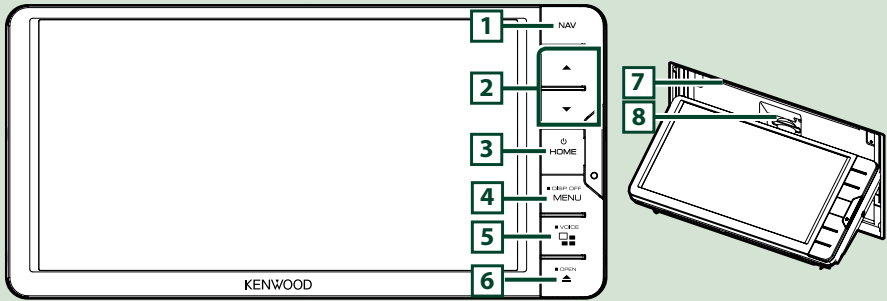



### NOTE

- The panels shown in this guide are examples used to provide clear explanations of the operations. For this reason, they may be different from the actual panels.
- In this manual, each model name is abbreviated as follows.  
DNX716WDABS: **DNX7**  
If above icon is showed, read the article applicable to the unit you use.

## How to insert an SD Card

- 1) Press **7** <▲> button.
  - 2) Touch [OPEN] to the panel fully opens.
  - 3) Hold the SD card as the illustration in the right and insert it into the slot until it clicks.
  - 4) Press **7** <▲> button.
- **To eject the card:**
- 1) Press **7** <▲> button.
  - 2) Touch [OPEN].
  - 3) Push the card until it clicks and then remove your finger from the card. The card pops up so that you can pull it out with your fingers.
  - 4) Press **7** <▲> button.

Number	Name	Motion
1	NAV	<ul style="list-style-type: none"> <li>Displays the navigation screen.</li> </ul>
2	▼, ▲ (Volume)	<ul style="list-style-type: none"> <li>Adjusts volume.</li> <li>The volume will go up until 15 when you keep pressing [ ▲ ].</li> </ul>
3	HOME	<ul style="list-style-type: none"> <li>Displays the HOME screen <a href="#">(P.22)</a>.</li> <li>Pressing for 1 second turns the power off.</li> <li>When the power off, turns the power on.</li> </ul>
4	MENU	<ul style="list-style-type: none"> <li>Displays the popup menu screen.</li> <li>Pressing for 1 second turns the screen off.</li> </ul>
5		<ul style="list-style-type: none"> <li>Displays the APP (CarPlay/ Android Auto/ Mirroring) screen.</li> <li>Pressing for 1 second displays the Voice Recognition screen. <a href="#">(P.73)</a></li> </ul>
6		<ul style="list-style-type: none"> <li>Displays the Angle Adjust screen.</li> <li>– [DISC EJECT]: Ejects the disc.</li> <li>– [OPEN]: Fully opens the panel to the location of the SD card slot.</li> <li>When the panel is opened, pressing closes the panel.</li> <li>To forcibly eject the disc, press it for 2 seconds and touch [DISC EJECT] after the message is displayed.</li> </ul>
7	Disc insert slot	<ul style="list-style-type: none"> <li>A slot to insert a disc media.</li> </ul>
8	SD card slot	<ul style="list-style-type: none"> <li>A slot to insert an SD card.</li> <li>You can play audio/visual file in the card. *</li> <li>An SD card slot for upgrading the map. For how to upgrade the map, refer to the instruction manual of the navigation system.</li> </ul>

\* If the map update file remains in the SD card, you cannot play audio/visual file.

## DNX5160DABS/DNX5160BTS/DNX3160BT

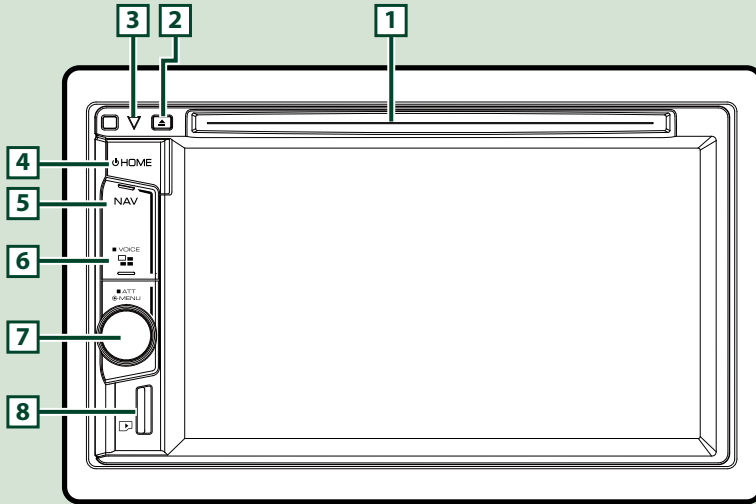

### NOTE

- The panels shown in this guide are examples used to provide clear explanations of the operations. For this reason, they may be different from the actual panels.
- In this manual, each model name is abbreviated as follows.  
DNX516DABS, DNX5160BTS: **DNX5**  
DNX3160BT: **DNX3**  
If above icons are showed, read the article applicable to the unit you use.

## How to insert a microSD Card

### NOTE

- A dummy microSD card is inserted as the slot cover. Remove it before using and keep it in an appropriate place.



- 1) Hold the microSD card with the label side facing right and the notched section down, and insert it into the **8** slot until it clicks.

### ● To eject the card:

Push the card until it clicks and then remove your finger from the card.

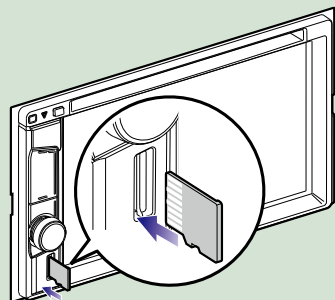
The card pops up so that you can pull it out with your fingers.



Number	Name	Motion
<b>1</b>	Disc insert slot	<ul style="list-style-type: none"> <li>• A slot to insert a disc media.</li> </ul>
<b>2</b>	 (Eject)	<ul style="list-style-type: none"> <li>• Ejects the disc.</li> <li>• To forcibly eject the disc, press it for 2 seconds and touch [Yes] after the message is displayed.</li> </ul>
<b>3</b>		<ul style="list-style-type: none"> <li>• This indicator flashes when the vehicle ignition is off <a href="#">(P.82)</a>.</li> </ul>
<b>4</b>	HOME	<ul style="list-style-type: none"> <li>• Displays the HOME screen <a href="#">(P.22)</a>.</li> <li>• Pressing for 1 second turns the power off.</li> <li>• When the power off, turns the power on.</li> </ul>
<b>5</b>	NAV	<ul style="list-style-type: none"> <li>• Displays the navigation screen.</li> </ul>
<b>6</b>		<ul style="list-style-type: none"> <li>• Displays the APP (CarPlay) screen.</li> <li>• Pressing for 1 second displays the Voice Recognition screen. <a href="#">(P.73)</a></li> </ul>
<b>7</b>	Volume Knob	<ul style="list-style-type: none"> <li>• Turn to adjust the volume.</li> <li>• Press to display the pop-up menu.</li> <li>• Pressing for 1 second switches attenuation of the volume on/off.</li> </ul>
<b>8</b>	microSD card slot	<ul style="list-style-type: none"> <li>• A slot to insert a microSD card.</li> <li>• You can play audio/visual file in the card. * (Only for DNX5160DABS, DNX5160BTS)</li> <li>• A microSD card slot for upgrading the map. For how to upgrade the map, refer to the instruction manual of the navigation system.</li> </ul>

**\* If the map update file remains in the microSD card, you cannot play audio/visual file.**

## DNX516DABS

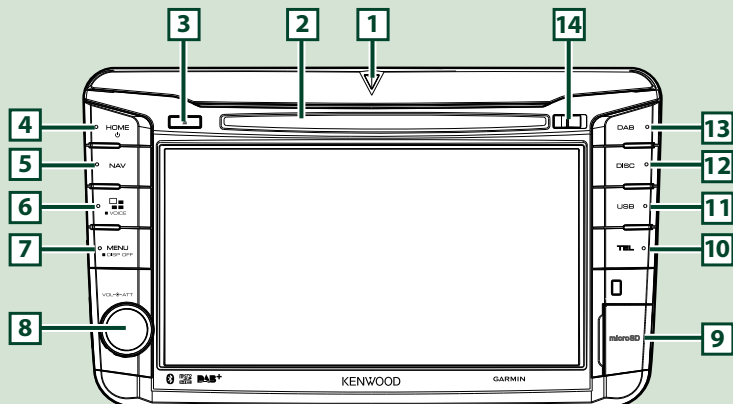

### NOTE

- The panels shown in this guide are examples used to provide clear explanations of the operations. For this reason, they may be different from the actual panels.
  - In this manual, each model name is abbreviated as follows.  
DNX516DABS: **DNX5**
- If above icons are showed, read the article applicable to the unit you use.

## How to insert a microSD Card

- 1) Open the **9** microSD card slot cover as the illustration in the right.
- 2) Hold the microSD card with the label side facing right and the notched section down, and insert it into the slot until it clicks.

### ● To eject the card:

- 1) Open the **9** microSD card slot cover as the illustration in the right.
- 2) Push the card until it clicks and then remove your finger from the card.
- 3) The card pops up so that you can pull it out with your fingers.

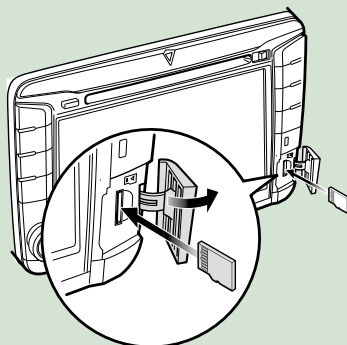

### NOTE

- When detaching a part of the front panel, detach it toward the front side as shown in the diagram right. If it is detached upward, the front panel will be broken.

Number	Name	Motion
<b>1</b>	▽	• This indicator flashes when the vehicle ignition is off <a href="#">(P.82)</a> .
<b>2</b>	Disc insert slot	• A slot to insert a disc media.
<b>3</b>	▲ (Eject)	• Ejects the disc. • To forcibly eject the disc, press it for 2 seconds and touch [Yes] after the message is displayed.
<b>4</b>	HOME	• Displays the HOME screen <a href="#">(P.22)</a> . • Pressing for 1 second turns the power off. • When the power off, turns the power on.
<b>5</b>	NAV	• Displays the navigation screen.
<b>6</b>		• Displays the APP (CarPlay/ Android Auto) screen. • Pressing for 1 second displays the Voice Recognition screen. <a href="#">(P.73)</a>
<b>7</b>	MENU	• Displays the popup menu screen. • Pressing for 1 second turns the screen off.
<b>8</b>	Volume Knob	• Turning adjusts volume up or down. • Pressing switches attenuation of the volume on/off.
<b>9</b>	microSD card slot	• A slot to insert a microSD card. • You can play audio/visual file in the card. * • A microSD card slot for upgrading the map. For how to upgrade the map, refer to the instruction manual of the navigation system.
<b>10</b>	TEL	• Displays the Hands Free screen. <a href="#">(P.70)</a>
<b>11</b>	USB	• Switches to the USB sources. <a href="#">(P.37)</a>
<b>12</b>	DISC	• Switches to the disc media sources. <a href="#">(P.28)</a>
<b>13</b>	DAB	• Switches to the DAB sources. <a href="#">(P.54)</a>
<b>14</b>	Release key	• Detaches the part of front panel.

\* If the map update file remains in the microSD card, you cannot play audio/visual file.

## Turning on the Unit

The method of turning on is different depending on the model.

### 1 Press the <HOME> button.

DNX8160DABS

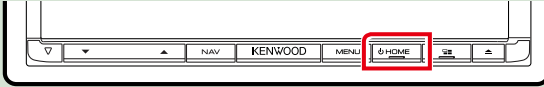

DNX716WDABS

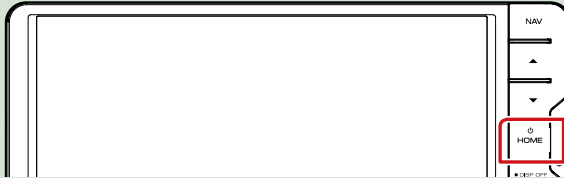

DNX5160DABS / DNX5160BTS / DNX3160BT

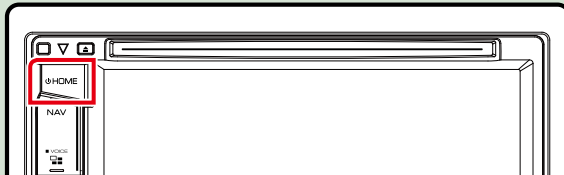

DNX516DABS

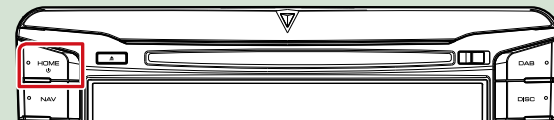

The unit is turned on.

### ● To turn off the unit:

Press the <HOME> button for 1 second.

If it is your first time turning the unit on after installation, it will be necessary to perform [Initial setup \(P.15\)](#).

## Initial setup

Perform this setup when you use this unit first time.

### 1 Set each item as follows.

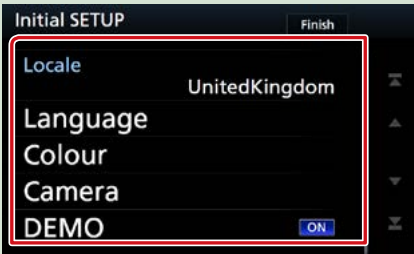

#### Locale

Select the country for the navigation system.

The language, the distance unit, and the gasoline unit are set.

- ① Touch [Locale].
- ② Select the desired country.

#### Language

Select the language used for the control screen and setting items. Default is "British English(en)".

- ① Touch [Language].
- ② Touch [Language Select].
- ③ Select the desired language.
- ④ Touch [].

For detailed operation, see [User Interface Setup \(P.78\)](#).

#### Colour

Set the screen and button illumination color. You can select whether to allow color scan operation or select a fixed color for operation.

- ① Touch [Colour].
- ② Touch [Panel Colour].
- ③ Select the desired color.
- ④ Touch [] twice.

For detailed operation, see [Display Setup \(P.83\)](#).

#### Camera

Set the parameters for the camera.

- ① Touch [Camera].
- ② Set each item and touch [].

For detailed operation, see [Camera Setup \(P.85\)](#).

#### DEMO

Set the demonstration mode. Default is "ON".

- ① Touch [DEMO] and set ON or OFF.

**Continued**



**2** Touch [Finish].

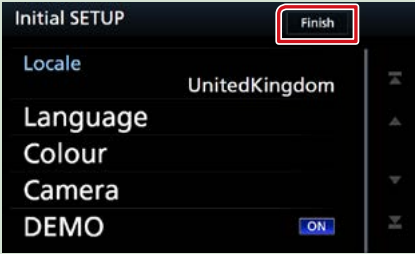

**NOTE**

- These settings can be set from the SETUP menu. See [Setting Up \(P.76\)](#).

## How to Play Media

### Music CD and disc media

#### DNX8 DNX7

- 1 Press the <▲> button.



- 2 Touch [DISC EJECT].

The panel opens.

- 3 Insert the disc into the slot.

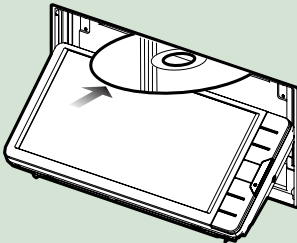
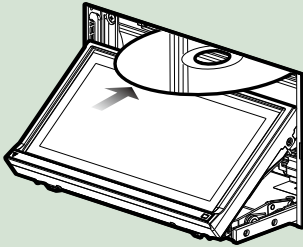

The panel closes automatically.

The unit loads the disc and playback starts.

- To eject the disc:

- 1 Press the <▲> button.

- 2 Touch [DISC EJECT].

When removing a disc, pull it horizontally.

- 3 Press the <▲> button.

#### DNX5 DNX3

- 1 Insert the disc into the slot.

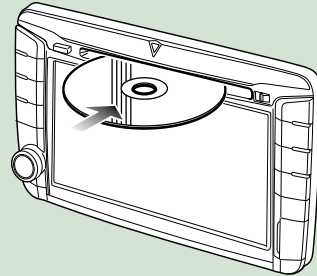
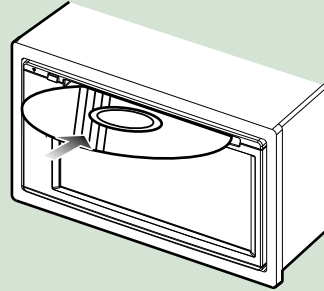

The unit loads the disc and playback starts.

- To eject the disc:  
Press the <▲> button.

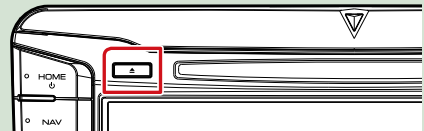

## USB device

- 1 Connect the USB device with the USB cable.

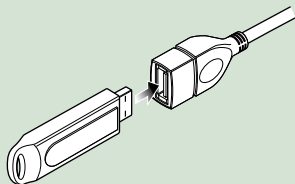

- 2 Press the <HOME> button.
  - 3 Touch [USB]. (P.22)
- To disconnect the device:
    - 1 Press the <HOME> button.
    - 2 Touch a source other than [USB].
    - 3 Detach the USB device.

## iPod

- 1 Connect the iPod.
- 2 Press the <HOME> button.
- 3 Touch [iPod]. (P.22)

### NOTE

• For the details of the necessary cable and adapter to connect with iPod/iPhone, refer to [CD/Audio and Visual Files/iPod/APPS \(P.34\)](#).

- To disconnect the iPod/iPhone connected with the cable:  
Detach the iPod/iPhone.

## SD card

### DNX8 DNX7

- 1 Press the <▲> button.



- 2 Touch [OPEN] to the panel fully opens.
- 3 Insert the SD card into the slot until it clicks.

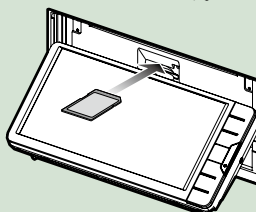
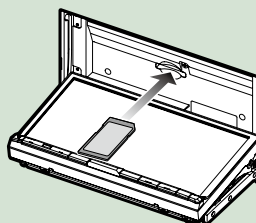

- 4 Press the <▲> button.
  - 5 Press the <HOME> button.
  - 6 Touch [SD]. (P.22)
- To remove:
    - 1 Press the <▲> button.
    - 2 Touch [OPEN] to the panel fully opens.
    - 3 Push the SD card until it clicks and then remove your finger from the card. The card pops up so that you can pull it out with your fingers.
    - 4 Press the <▲> button.

**DNX5**

- 1** Insert the microSD card into the slot until it clicks.

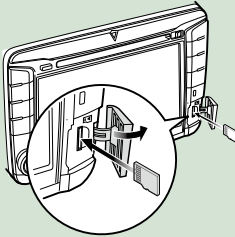
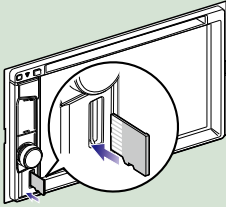

- 2** Press the <HOME> button.

- 3** Touch [SD]. [\(P.22\)](#)

- **To remove:**

Push the microSD card until it clicks and then remove your finger from the card. The card pops up so that you can pull it out with your fingers.

**NOTE**

- A dummy microSD card is inserted as the slot cover. Remove it before using and keep it in an appropriate place.

**HDMI/ MHL source****DNX8 DNX7**

You can display the screen of smartphones connected via the HDMI/MHL input terminal.

- 1** Press the <HOME> button.
- 2** Touch [  ].
- 3** Touch [HDMI/ MHL]. [\(P.22\)](#)
- 4** Start an application or playback on your smartphone.

- **About Wireless Display Adapter:**

This unit is compatible with Wireless Display Adapter. Connecting a Wireless Display Adapter (KCA-WL100: optional accessory) to the HDMI/MHL input terminal enables you to enjoy listening to music, watching videos, or viewing pictures over a wireless connection.

**NOTE**

- For details about Wireless Display Adapter settings, etc., refer to the instructions supplied with the Wireless Display Adapter.

## TV tuner

**(DNX8) (DNX7) (DNX5)**

You can connect the TV tuner (commercially available) with this unit and watch TV.

### Before use

- When you use TV control function, connect the TV tuner (commercially available) and set 3rd Party TV Tuner Control in [AV Setup \(P.87\)](#) to ON.
- The TV tuner can be controlled with its supplied remote control through the remote sensor on the front panel of this unit.

**1** Press the <HOME> button.

**2** Touch [  ].

**3** Touch [AV-IN1]. ([P.22](#))



**1**

### 1 Key display area

Touch to display the control screen.

### Menu control screen:

1) Touch [  ] Key display area.



2) Touch [TV Ctrl].

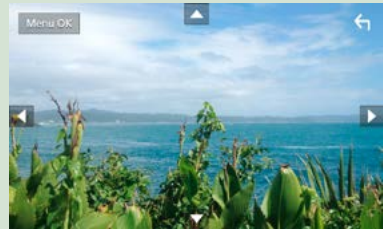

### Displays the menu/ Enters selected item

Touch [MENU/OK].

### Moves the cursor

Touch [▲], [▼], [◀], [▶].

### Exits menu control

Touch [  ].

## Detaching The Front Panel

You can detach the front panel to prevent theft.

### DNX8160DABS

- 1 Press the <▲> button.
- 2 Touch [OPEN] to the panel fully opens.

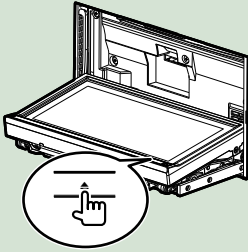

#### NOTE

- You can set the front panel to open automatically when the ignition is turned off. See [Monitor Angle Control \(P.77\)](#).

- 3 Detach the panel as the diagrams below.

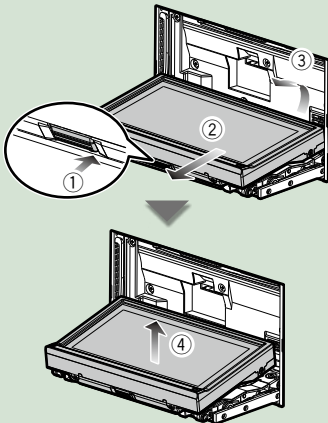

#### NOTE

- The attaching plate closes automatically in about 10 seconds after the front panel is released. Remove the panel before this happens.

### ● Attaching the front panel:

Hold the panel securely so as not to drop it accidentally, and fit it onto the attaching plate until it is firmly locked.

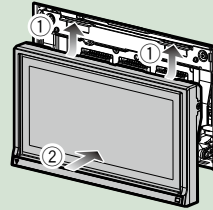

### DNX516DABS

- 1 Slide the Release key rightward to detach the part of the front panel.

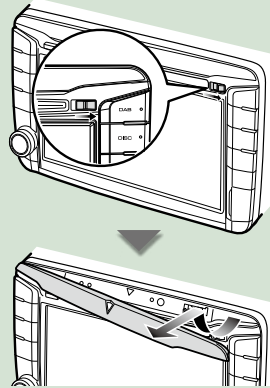

### ● Attaching the front panel:

Hold the panel securely so as not to drop it accidentally, and fit it onto the attaching plate until it is firmly locked.

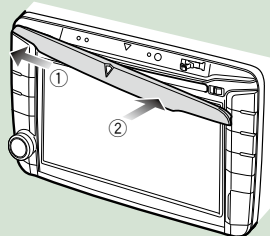

# Operating with the HOME Screen

Most functions can be performed from the HOME screen.

## 1 Press the <HOME> button.

DNX8160DABS



DNX5160DABS/ DNX5160BTS/ DNX3160BT

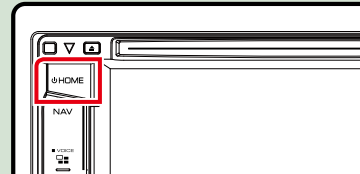

DNX716WDABS

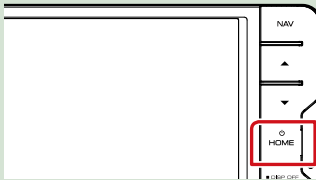

DNX516DABS



HOME screen appears.

## 2 Flick the screen left or right to select the widget.

Touch the widget to display the detailed screen.

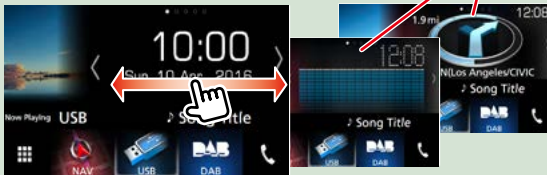

## Selecting the playback source on the HOME screen

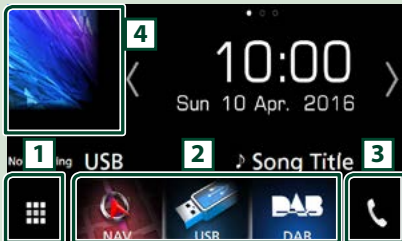





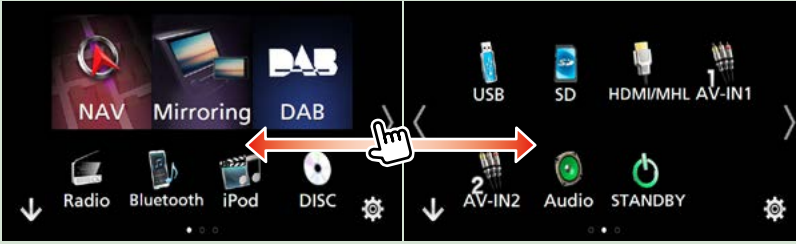







- 1 Displays the source selection screen.
- 2 Short-cut buttons.
- 3 Displays the Hands Free screen ([P.70](#)).
- 4 Displays the control screen of current source.

## 1 Touch [ ].



From this screen, you can perform the following functions.

Function	Icon	Operation
Switch the audio source	    etc.	Touch the icon of the desired source.
Switch the video source	  etc.	Touch the icon of the desired video source.
Switch the application installed in the iPhone/iPod or Android.	   etc.	Touch the icon of the desired application.
Display navigation screen		Touch [NAV].
Turn off all audio function		Touch [STANDBY].
Enter setup mode		Touch the icon of the desired setup function.

### ● Customizing Short-cut buttons on HOME screen

You can arrange the position of the source icons as you like.

1. Touch and hold the icon which you want to move to go into the customizing mode.
2. Drag it where you want to move.

### Customizing mode screen

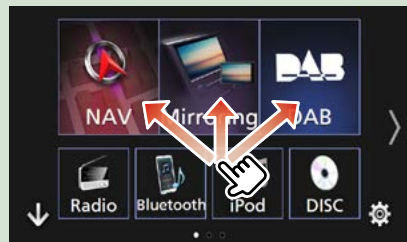



## Common Operations

Introduces the common operations.

### Popup menu

#### 1 Press the <MENU> button.

DNX8160DABS



DNX716WDABS

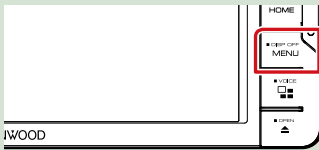

DNX516DABS



#### 1 Press the volume knob.

DNX5160DABS/ DNX5160BTS/ DNX3160BT

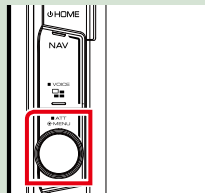

Popup menu appears.

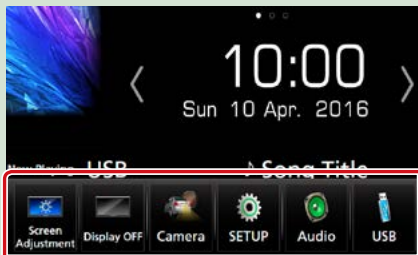

Touch to display the popup menu. The contents of the menu are as follows.

- : Displays the Screen Adjustment screen.
- : Turns the display off.
- : Displays the view camera.
- : Displays the SETUP Menu screen.
- : Displays the Audio Control Menu screen.
- : Displays the control screen of current source. Icon feature differs depending on the source.

### Source control screen descriptions

There are some functions which can be operated from most screens.

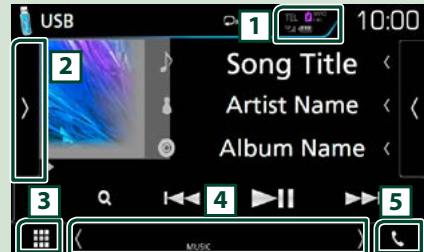

Indicators



Navigation information



Short-cut buttons

**1** Connected Bluetooth device information.

**2** : Lights up when quick charging battery of the connected iPod/ iPhone/ Smartphone.

**3** : Displays the function panel (other operation button window).

**4** : Displays all sources.

#### 4 Secondary screen

[<] [>]: The Secondary screen changes every time you touch it.

- **Indicators:** Displays the current source condition and so on.
- **Navigation information:** Displays the current location and the direction. The screen changes to the navigation screen when you touch here.
- **Short-cut buttons:** The source changes to the one you have set as a short-cut. For the short-cut setting, refer to [Customizing Short-cut buttons on HOME screen \(P.23\)](#).

#### 5 [F] [H]

Touch to display the Hands Free screen.

[\(P.70\)](#)

When connecting as Apple CarPlay or Android Auto, it works as a phone provided in Apple CarPlay or Android Auto.

## List screen

There are some common function keys in the list screens of most sources.

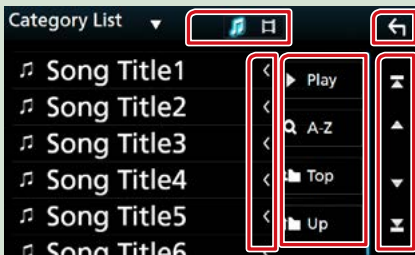

#### ← Return

Returns to previous screen.

#### < Text scroll

Scrolls the displayed text.

#### ▶ Play etc.

Keys with various functions are displayed here.

▶ **Play**: Play all tracks in the folder containing the current track.

🔍 **A-Z**: Jump to the letter you entered (alphabet search).

📁 **Top** 📁 **Up**: Moves to the upper hierarchy.

🎵 📁: Displays music/movie file list.

#### [▲] / [▼] / [↶] / [↷] Page scroll

You can change the page to display more items by pressing [▲]/[▼].

[↶]/[↷]: Displays the top or bottom page.

## Flick scrolling

You can scroll the list screen by flicking the screen up/down.

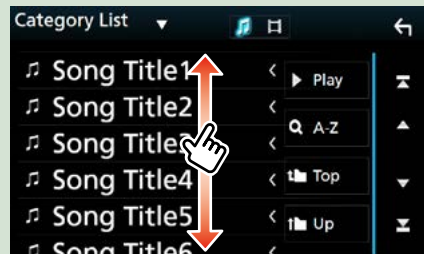

## Navigation Operation

For details on the navigation function, please refer to the Navigation Instruction Manual.

### Display the navigation screen

- 1 Press the <NAV> button.

DNX8160DABS

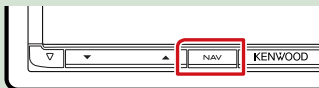

DNX716WDABS

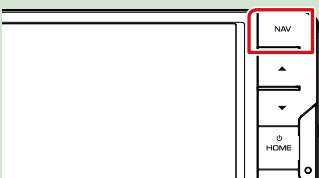

DNX5160DABS/ DNX5160BTS/ DNX3160BT

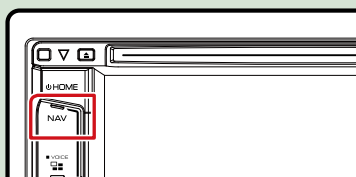

DNX516DABS

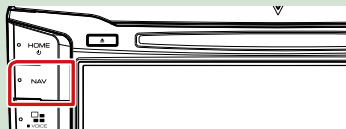

The navigation screen appears.

## Control audio from the navigation screen



You can control audio sources while the navigation screen is displayed.

Also, you can view the navigation information while the source control screen is displayed.

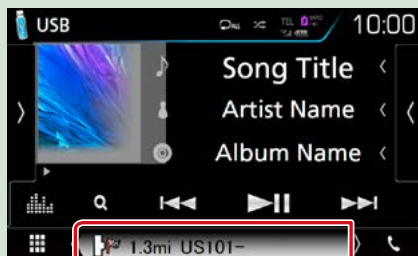
- 1 Touch the Navigation information of Secondary screen.



The navigation screen with audio information appears.

- 2 Each time you touch [  ] / [  ] / [  ] in the navigation screen,



Touching this area displays the audio screen.



Displays the navigation and control keys of the current source.



Displays the navigation and current video/  
picture playback display.



#### NOTE

- The screen switches between playback screen and view camera each time the viewing area is touched.

To return to the full navigation screen:

#### NOTE

- For details on control keys, refer to the instructions in each section.
- [  ] : It does not appear if the control keys like AV-IN, HDMI/MHL, etc. are not exist.
- Touching the source icon in the bottom of the screen displays the full audio screen.

## KENWOOD Traffic Powered By INRIX

You can receive INRIX traffic information and weather forecast by connecting your iPhone or Android smartphone in which the "KENWOOD Traffic Powered By INRIX" application is installed to this unit.

#### Preparation

- Install the latest version of the KENWOOD Traffic Powered By INRIX application on your iPhone or Android.
  - iPhone: Search for "KENWOOD Traffic Powered By INRIX" in the Apple App Store to find and install the most current version.
  - Android: Search for "KENWOOD Traffic Powered By INRIX" in Google play to find and install the most current version.
- For details, see "KENWOOD Traffic Powered By INRIX" application.

### 1 Register the Smartphone.

See [APP/iPod settings \(P.35\)](#).

### 2 Press the <NAV> button.

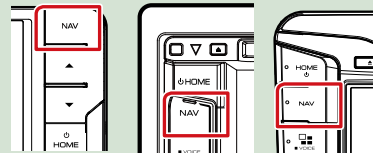

Navigation screen appears.

Touch [Apps] on the Main Menu screen  
and then an icon of your desired content

For details, see Navigation system manual.

# DVD/Video CD (VCD)

## DVD/VCD Basic Operation

Most functions can be controlled from the source control screen and playback screen.

**NOTE**

- Set the remote control mode switch to DVD mode before starting operation, see [Switching the operation mode \(P.101\)](#).
- The screen shot below is for DVD. It may be different from the one for VCD.

**1** When the operation buttons are not displayed on the screen, touch the **6** area.



### 1 Information display

Displays the following information.

- **Title #, Chap #:** DVD title and chapter number display
- **Track #/Scene #:** VCD track or scene number display  
Scene # is displayed only when Playback control (PBC) is on.
- **[Hide]:** Hides the control screen.
- **[Repeat]:** Repeats the current content. Each time you touch the key, repeat mode switches in the following sequence;  
DVD: Title repeat ( [Repeat Title] ), Chapter repeat ( [Repeat Chapter] ), Repeat off ( [Repeat Off] )  
VCD (PBC On): Does not repeat  
VCD (PBC Off): Track repeat ( [Repeat Track] ), Repeat off ( [Repeat Off] )

### 2 Function bar

Various functions can be performed by using keys in this area. For details on the keys, see [Function bar \(P.29\)](#).

- **[Equalizer]:** Displays the Graphic Equalizer screen. [\(P.92\)](#)

### 3 Function panel

Touch on the left side of the screen to display the function panel. Touch again to close the panel. For details on the keys, see [Function panel \(P.30\)](#).

### 4 Play mode indicator

- **▶, ▶▶, ■, etc.:** Current play mode indicator  
The meanings of each icon are as follows; ▶ (play), ▶▶ (fast forward), ◀◀ (fast backward), ■ (stop), **R** (resume stop), || (pause), |▶ (slow playback), ◀| (slow reverse playback).

**5 Searching area**

Touch to search the next/previous content.

**6 Key display area**

Touch to display the control screen.

**NOTE**

- The control screen disappears when no operation is done for 5 seconds.
- If you use a remote control, you can jump directly to the desired image with entering the chapter number, scene number, play time, etc. ([P.101](#)).

**Function bar****DVD****VCD**

The functions of each key are as follows.

[<<<] [>>>]

Searches the previous/next content.

Touch and hold to fast forward or fast backward. (It will be cancelled automatically after about 50 seconds.)

[▶ ||]

Plays or pauses.

## Function panel

### 1 Touch on the left side of the screen.



The functions of each key are as follows.

#### [■]

Stops playback. When touched twice, the disc is played from the beginning when you play it the next time.

#### [<<] [>>]

Fast forward or fast backward. Each time you touch the key, the speed changes; 2 times, 8 times.

#### [<] or [>] (DVD only)

Plays in slow motion forward or backward.

#### [SETUP] (DVD only)

Touch to display the DVD SETUP screen. See [DVD Setup \(P.32\)](#).

#### [MENU CTRL] (DVD only)

Touch to display the DVD-VIDEO disc menu control screen. See [DVD Disc Menu Operation \(P.31\)](#).

#### [PBC] (VCD only)

Turn Playback control (PBC) on or off.

#### [Audio] (VCD only)

Change the audio output channel.

## DVD Disc Menu Operation

You can set up some items in the DVD-VIDEO disc menu.

### 1 Touch illustrated area during playback.



### 2 Touch on the left side of the screen. Touch [MENU CTRL].

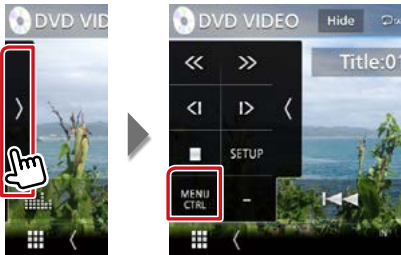

Menu Control screen appears.

### 3 Perform desired operation as follows.

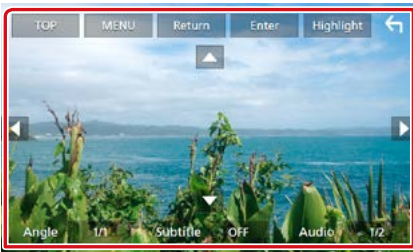

#### Displays the top menu

Touch [TOP].\*

#### Displays the menu

Touch [MENU].\*

#### Displays the previous menu

Touch [Return].\*

#### Enters selected item

Touch [Enter].

#### Enables direct operation

Touch [Highlight] to enter the highlight control mode (P.31).

#### Moves the cursor

Touch [▲], [▼], [◀], [▶].

#### Switches the subtitle language

Touch [Subtitle]. Each time you touch this key, language is switched.

#### Switches the audio language

Touch [Audio]. Each time you touch this key, language is switched.

#### Switches the picture angle

Touch [Angle]. Each time you touch this key, picture angle is switched.

\*These keys may not function depending on the disc.

## Highlight control

Highlight control lets you control the DVD menu by touching the menu key directly on the screen.

### 1 Touch [Highlight] in the Menu Control screen.

### 2 Touch desired item on the screen.



#### NOTE

- The highlight control is cleared automatically if you do not operate for a constant time.



## DVD Setup

You can set up the DVD playback functions.

### NOTE

- Each operation in this section can be started from the HOME screen. For details, see [Operating with the HOME Screen \(P.22\)](#).
- Some setup items can only be set in standby mode.

- 1 Touch on the left side of the screen. Touch [SETUP].

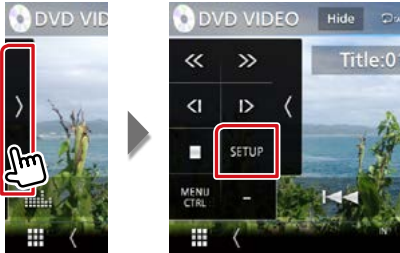

DVD SETUP screen appears.

- 2 Set each item as follows.



### Menu/Subtitle/Audio Language

See [Language setup \(P.33\)](#).

### Dynamic Range Control

Sets the dynamic range.

**Wide:** The dynamic range is wide.

**Normal:** The dynamic range is normal.

**Dialog (Default):** Makes the total sound volume larger than other modes. This is effective only when you are using Dolby Digital software.

### Screen Ratio

Sets the screen display mode.

**16:9 (Default):** Displays wide pictures.

**4:3 LB:** Displays wide pictures in the Letter Box format (having black stripes at the top and bottom of screen).

**4:3 PS:** Displays wide pictures in the Pan & Scan format (showing pictures cut at the right and left ends).

## Language setup

This setting is for the language used in the menu, subtitle, and voice.

- 1 **Touch the desired item; [Menu Language], [Subtitle Language], [Audio Language].**

Language Set screen appears.

- 2 **Select a language.**



For language code, refer to [DVD Language Codes \(P.115\)](#).

Sets the entered language and returns to the DVD Setting screen.

### NOTE

- To set the DVD's original language for audio language, touch [Original].

# CD/Audio and Visual Files/iPod/APPS

See the following sections for each source operation.

- **Music CD** [\(P.36\)](#)
- **Disc media** [\(P.37\)](#)
- **USB device** [\(P.37\)](#)
- **iPod** [\(P.37\)](#)
- **Spotify** [\(P.44\)](#)
- **Mirroring** [\(P.46\)](#)
- **Apple CarPlay** [\(P.48\)](#)
- **Android Auto** [\(P.50\)](#)

## Preparation

- To connect the Android device with this unit, the cable (sold separately) and the profile which your Android device supports are necessary as follows:

Use application	Sold separately	Automotive Mirroring	
To Android Auto source *1 (Android version 5.0 (Lollipop) or later)	Micro USB to USB cable	ON <a href="#">(P.50)</a>	
Use application	Sold separately	APP Connection select	Bluetooth Connection
To listen to music and watch video of Mirroring source *2	<ul style="list-style-type: none"> <li>• MHL or HDMI device</li> <li>• KCA-MH100 (MHL) or KCA-HD100 (HDMI)</li> </ul>	<ul style="list-style-type: none"> <li>• Android Bluetooth</li> <li>• HDMI/MHL</li> </ul>	Audio (A2DP)/App (SPP)
To listen to music of Bluetooth Audio source	–	–	Audio (A2DP)/App (SPP)

- To connect the iPod/iPhone with this unit, the cable, adapter (both sold separately), and the profile which your iPod/iPhone supports are necessary as follows:

Use application	Sold separately	Automotive Mirroring	
To Apple CarPlay source	KCA-iP103	ON <a href="#">(P.48)</a>	
Use application	Sold separately	APP Connection select (iPod Connection)	Bluetooth Connection
To listen music and watch video with Lightning connector device *2	<ul style="list-style-type: none"> <li>• Lightning Digital AV Adapter</li> <li>• KCA-HD100</li> <li>• KCA-iP103</li> </ul>	<ul style="list-style-type: none"> <li>• iPhone Bluetooth</li> <li>• HDMI/MHL (Bluetooth+HDMI/MHL)</li> </ul>	Audio (A2DP)/App (SPP)
To listen music with Lightning connector device	KCA-iP103	iPhone USB (USB)	–
To listen music with 30-pin connector device	KCA-iP102	iPhone USB (USB)	–
To listen to music via Bluetooth	–	iPhone Bluetooth (Bluetooth)	Audio (A2DP)/App (SPP)

- When connecting with Lightning Digital AV Adapter some applications can be controlled from this unit. The operable functions depend on the application.
- Do not leave the cable or the adapter made by other makers inside the car. It might lead the malfunction caused by heat.
- Some settings are necessary to meet the connected iPod/iPhone or Android device. Refer to [APP/iPod settings \(P.35\)](#) and [Connecting the Bluetooth unit \(P.66\)](#).

\*1 **DNX8/7** DNX516DABS only

\*2 **DNX8/7** only

## APP/iPod settings

Select how to connect your android smartphone or iPhone to use apps like Mirroring, etc.

### Preparation

- To connect an Android device or iPhone via Bluetooth, register it as the Bluetooth device and do the profile setting of the connection beforehand. See [Registering from the Bluetooth unit \(P.65\)](#) and [Connecting the Bluetooth unit \(P.66\)](#).

**1** Press the **DNX8/7** <MENU> button/**DNX5/3** volume knob.

Pop up menu appears.

**2** Touch **[SETUP]**.

SETUP Menu screen appears.

**3** Touch **[AV]**.



AV screen appears.

**4** Set **[Automotive Mirroring]** to **[OFF]**.

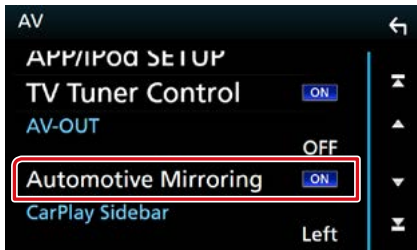

**5** Touch **[APP/iPod SETUP]**.



App/iPod SETUP screen appears.

**6** Set each item as follows.



### APP Connection select

Select how to connect your smartphone.

**Android Bluetooth:** Connect an Android smartphone via Bluetooth.

**iPhone Bluetooth:** Connect an iPhone via Bluetooth.

**HDMI/MHL:** Connect an Android smartphone or iPhone via Bluetooth and watch its video via HDMI/MHL. (**DNX8/7** only)

**iPhone USB:** Connect an iPhone through an USB cable.

### iPod Connection

It shows how the device that is used in the iPod source is connected. It changes depending on the "APP Connection select".

**7** Touch **[Done]**.

### NOTE

- After changing the setting if the unit does not work correctly, turn off the power of the unit and then turn on again.

## Music/Video Basic Operation

Most functions can be controlled from the source control screen and playback screen.

### NOTE

- Set the remote controller mode switch to AUD mode before starting operation, see [Switching the operation mode \(P.101\)](#).
- In this manual, "Music CD" will be referred to as the general CDs which include music tracks in. "Disc media" will be referred to as CD/DVD disc which includes audio, picture or video files.
- The screen shot below is for CD. It may be different from the one for disc media.

## Music CD

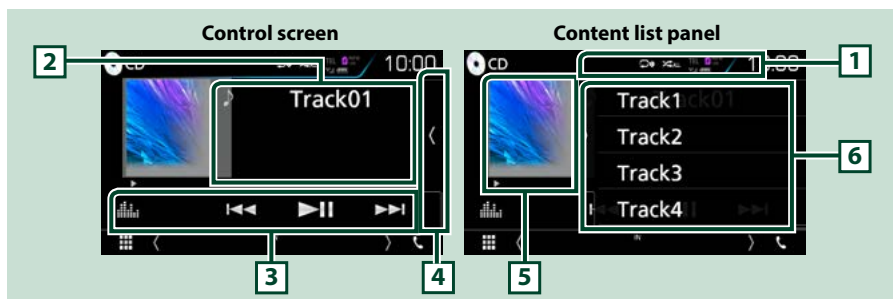

### 1 [ ] / [ ]

- [ ]: Repeats the current track. Each time you touch the key, repeat mode switches in the following sequence; Track repeat ( ), Repeat all ( )
- [ ]: Randomly plays all tracks in disc. Each time you touch the key, random mode switches in the following sequence; Track random ( ), Random off ( )

### 2 Track information

Displays the information of the current track.

### 3 Function bar

Various functions can be performed by using keys in this area. For details on the menu, see [Function bar \(P.38\)](#).

- [ ]: Displays the Graphic Equalizer screen. [\(P.92\)](#)

### 4 Content list

Touching on the screen or flicking the screen to left will display the Content list. Touching again or flicking to right will close the list.

### 5 Play mode indicator

- , , etc.: Current play mode indicator  
The meanings of each icon are as follows; (play), (fast forward), (fast backward), (pause).

### 6 Content list panel

Displays the playing list. When you touch a track/file name on the list, playback will start.

## Disc media, USB device, SD card, and iPod

To enter USB/ SD/ iPod source, touch [USB], [SD] or [iPod] icon in the HOME screen.

### NOTE

- SD card is for **DNX3**, **DNX7**, and **DNX5** only.
- The screen shot below is for USB device. It may be different from the one for iPod.

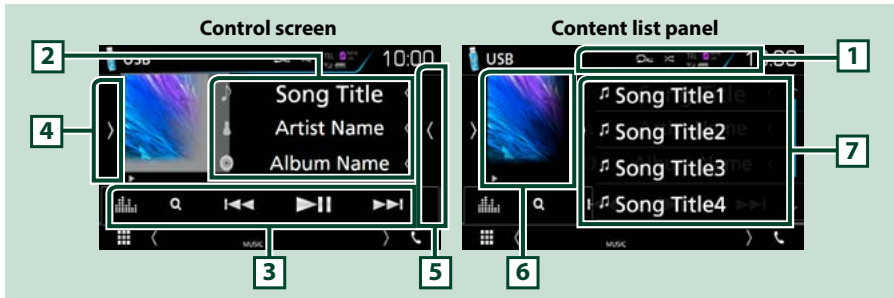

### 1 [ ] / [ ]

• [ ]: Repeats the current track/folder. Each time you touch the key, repeat mode switches in the following sequence;

Disc media, USB device, SD card: File repeat ( ), Folder repeat ( ), Repeat all ( )

iPod: Song repeat ( ), All songs repeat ( )

• [ ]: Randomly plays all tracks in current folder/disc. Each time you touch the key, random mode switches in the following sequence;

Disc media, USB device, SD card: File random ( ), Random off ( )

iPod: Song random ( ), Album random ( ), Random off ( )

### 2 Track information

• Displays the information of the current file.

Only a file name and a folder name are displayed if there is no tag information.

• Touch to display the category list screen. See [Category search \(P.40\)](#).

### 3 Function bar

Various functions can be performed by using keys in this area. For details on the keys, see [Function bar \(P.38\)](#).

• [ ]: Displays the Graphic Equalizer screen. [\(P.92\)](#)

### 4 Function panel

Touch on the left side of the screen to display the function panel. Touch again to close the panel. For details on the keys, see [Function panel \(P.39\)](#).

### 5 Content list

Touching on the screen or flicking the screen to left will display the Content list. Touching again or flicking to right will close the list.

### 6 Artwork/ Play mode indicator

The jacket of the currently playing file is displayed.

• : Current play mode indicator

The meanings of each icon are as follows; (play), (fast forward), (fast backward), (pause).

**Continued**

### 7 Content list panel

Displays the playback list. When you touch a track/file name on the list, playback will start.



### 8 Searching file area (picture/video file only)

Touch to search the next/previous file.

### 9 Key display area (picture/video file only)

Touch to display the control screen.

## Function bar

### Music CD



### Disc media



### iPod



### USB device and SD card



The following functions can be performed by using keys in this area.

### [Q] (Disc media, iPod, USB device, and SD card only)

Searches track/file. For details on search operation, see [Search Operation \(P.40\)](#).

### [<<<] [>>>]

Searches the previous/next track/file.

Touch and hold to fast forward or fast backward. (audio and video file only) (It will be cancelled automatically after about 50 seconds.)

### [▶ ||]

Plays or pauses.

## Function panel

### 1 Touch on the left side of the screen.



The following functions can be performed by using keys in this area.

[ + ] [ - ] (disc media, USB device, and SD card only)

Searches previous/next folder.

[USB DEVICE CHANGE] (Only for USB device of DNX3 / DNX7 / DNX5)

Switches to another USB device when two USB devices are connected.



## Search Operation

You can search music or video files by the following operations.

### NOTE

- If you use a remote control, you can jump directly to the desired track/file with entering the track/folder/file number, play time, etc. For details, see [Direct search mode \(P.101\)](#).

### List search

You can search tracks, folders, and files according to hierarchy.

#### 1 Touch on the right side of the screen.

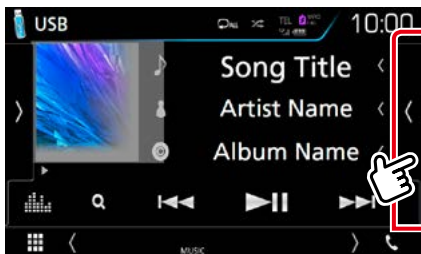

Control list appears.

#### 2 Touch desired track/file.

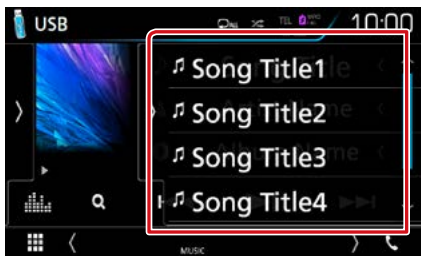

Playback starts.

### NOTE

- For disc media, you cannot display the list during random play and stop.

### Category search (USB device, iPod, and SD card only)

You can search a file by selecting category.

#### 1 Touch [Q].

Category List screen appears.

#### 2 Touch [▼].



#### 3 Touch [Category List].

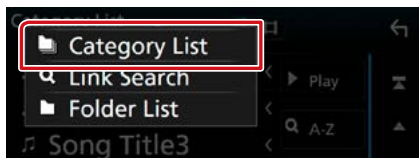

#### 4 Select whether you search by audio files [🎵] or video files [📺].

#### 5 Touch the desired category.

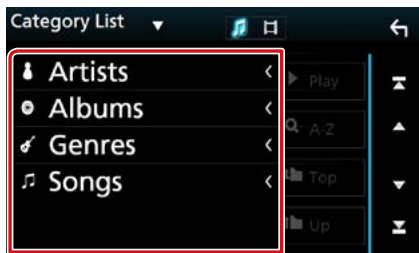

#### 6 The list is sorted by selected category.

#### 7 Touch desired item.

Playback starts.

### NOTE

- Touch [A-Z] to narrow the search you can select a letter.
- For operations in the list screen, see [List screen \(P.25\)](#).

## Link search (USB device, iPod, and SD card only)

You can search a file of same artist/album/genre/composer as the current track.

### 1 Touch [Q].

Category List screen appears.

### 2 Touch [▼].

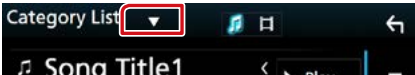

### 3 Touch [Link Search].

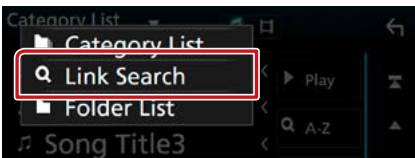

### 4 Touch the desired item. You can select from artist, album, genre and composer.



The list corresponding to your selection appears.

#### NOTE

- The list is sorted by the way you selected.
- **Artists:** Displays the album list of the artist.
- **Albums:** Displays all tunes of the current album.
- **Genres:** Displays the artists list in which artists belong to the same genre.
- **Composers:** Displays the album list of the composer of the current file.

#### NOTE

- Touch [A-Z] to narrow the search you can select a letter.
- For operations in the list screen, see [List screen \(P.25\)](#).

### 5 Touch to select desired item in the list. Repeat this step until you find the desired file.

## Folder search (USB device, disc media, and SD card only)

You can search a file according to hierarchy.

### 1 Touch [Q].

Category List screen appears.

### 2 Touch [▼].

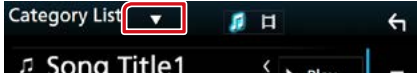

### 3 Touch [Folder List].

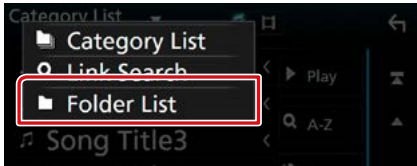

### 4 Touch the desired folder.

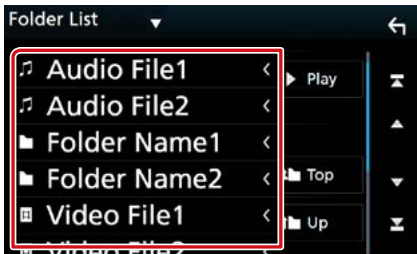

When you touch a folder its contents are displayed.

### 5 Touch desired item from the content list.

Playback starts.

#### NOTE

- For operations in the list screen, see [List screen \(P.25\)](#).



## Spotify Operation

You can listen to the Spotify on this unit by controlling the application installed in the iPhone or Android.

To enter Spotify source, touch [Spotify] icon in the HOME screen.

### Preparation

- Install the latest version of the Spotify application "Spotify" on your iPhone or Android.
- **iPhone:** Search for "Spotify" in the Apple App Store to find and install the most current version.
- **Android:** Search for "Spotify" in Google play to find and install the most current version.
- Select how to connect the unit with your smartphone. For the details, refer to [APP/iPod settings \(P.35\)](#).

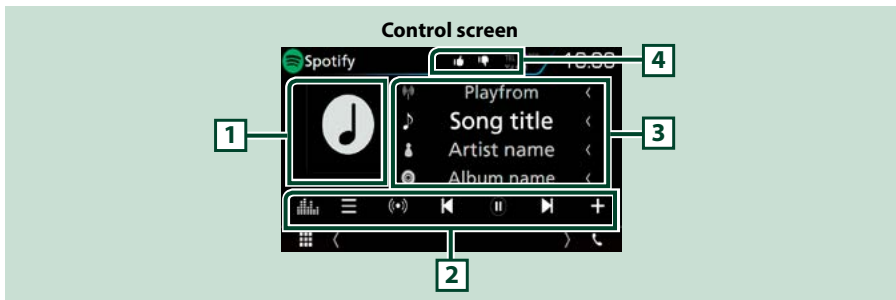

### 1 Artwork

The picture data is displayed if available from current content.

### 2 Function bar





Various functions can be performed by using keys in this area. For details on the keys, see [Function bar \(P.45\)](#).

- [  ]: Displays the Graphic Equalizer screen. [\(P.92\)](#)

### 3 Content information

Displays the information of the current content being played.

### 4 [ ] / [ ] / [ ] / [ ]

- [  ]: Thumbs down to the current song and skip to the next song.
- [  ]: Registers the current contents as favorite content.
- [  ]: Repeats the current song.
- [  ]: Randomly plays all song in current playlist.

## Function bar



The following functions can be performed by using keys in this area.



Displays the Menu screen



New radio station that relates to the artist of the currently playing song is selected and playback starts.



Skips the current song.



Plays or pauses the content of the current station.



Saves currently playing song to My Music.

## Selecting a track

### 1 Touch [ ].

Menu screen appears.

### 2 Select the list type, then select a desired item.



#### Selects the category and station

Touch the category and station name in the list.



Returns to the first hierarchy of the list.



Returns to the previous list.

### About Spotify®

#### iPhone or iPod touch

- Install the latest version of the Spotify application on your iPhone or iPod touch. (Search for “Spotify” in the Apple iTunes App Store to find and install the most recent version.)

#### Android™

- Visit Google play and search for “Spotify” to install.

#### Note

- Ensure you are logged in to your smartphone application. If you do not have an Spotify account, you can create one for free from your smartphone or at [www.spotify.com](http://www.spotify.com).
- Because Spotify is a third-party service, the specifications are subject to change without prior notice. Accordingly, compatibility may be impaired or some or all of the services may become unavailable.
- Some functions of Spotify cannot be operated from this unit.
- For issues using the application, contact Spotify at [www.spotify.com](http://www.spotify.com).
- An active internet connection.

## Mirroring Operation ( DNX8 DNX7 )

You can listen to music or watch video from the Mirroring operating on Android.

### Preparation

- Install the latest version of the KENWOOD Smartphone Control application on your Android. Search for "KENWOOD Smartphone Control" in Google play to find and install the most current version.  
For details, see web site. [http://www.kenwood.com/products/car\\_audio/app/kenwood\\_smartphone\\_control/eng/](http://www.kenwood.com/products/car_audio/app/kenwood_smartphone_control/eng/)
- The unit and the Android device are connected with MHL (KCA-MH100 ; sold separately) or HDMI (KCA-HD100 ; sold separately) and over Bluetooth profile HID and SPP.
- Screen calibration of Android device is required only when making the connection for the first time. Recalibration is only necessary when the output screen size of the Android device had been changed.
- Select how to connect the unit with your smartphone. For the details, refer to [APP/iPod settings \(P.35\)](#).

### Preparation

- 1 Press the <MENU> button.**  
Popup menu appears.
- 2 Touch [SETUP].**  
SETUP Menu screen appears.
- 3 Touch [AV].**  
AV screen appears.
- 4 Set [Automotive Mirroring] to [OFF].**

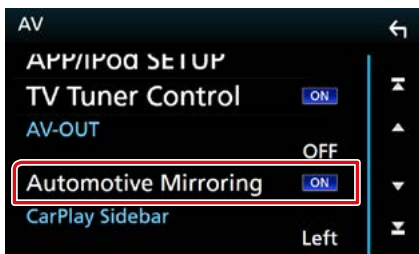

- 5 Touch [APP/iPod SETUP].**

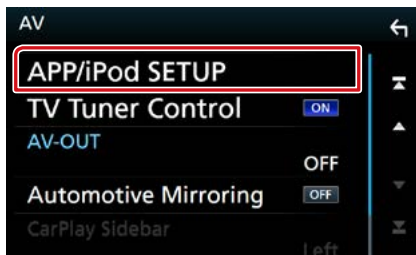

App/iPod SETUP screen appears.

- 6 Touch [Android Bluetooth].**



- 7 Touch [Done].**

- 8 Connect an Android device.**

## Operation

- 1 Press the <HOME> button.
- 2 Touch [  ].
- 3 Touch [Mirroring].
- 4 Touch [Agree].



If you drive using an app that is prohibited from using while driving, the confirmation screen appears. As you select [Yes], the launcher of “KENWOOD Smartphone Control” starts.

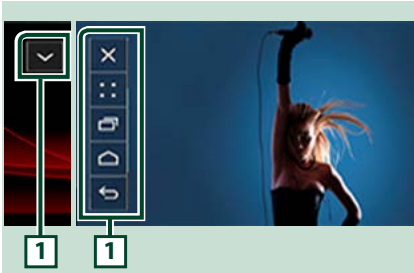

1

HOME / BACK / TASK Key will be displayed on this unit screen, and can be moved within the screen by dragging. In addition, it is possible to minimize these keys when they are not required.

HOME / BACK / TASK Key may not appear when using certain applications. (i.e. video application software etc.)

### NOTE

- Smartphone control from this unit is limited to a single finger operation like Tap/ Double Tap/ Long Tap/ Swipe.
- Operation that requires two or more fingers such as Pinch-in/ Pinch-out/ Multi-tap are unavailable.

## KENWOOD Music Control for Android

### Preparation

- Install the latest version of the KENWOOD Music Control application on your Android. Search for “KENWOOD Music Control for Android” in Google play to find and install the most current version. For details, see web site. [http://www.kenwood.com/car/app/kmc1\\_aapp/eng/](http://www.kenwood.com/car/app/kmc1_aapp/eng/)

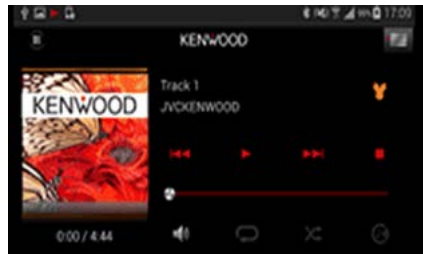

You can use KENWOOD Music Control as you use the smartphone to play music and video.



## Apple CarPlay Operation

CarPlay is a smarter, safer way to use your iPhone in the car. CarPlay takes the things you want to do with iPhone while driving and displays them on the screen of the product. You can get directions, make calls, send and receive messages, and listen to the music from iPhone while driving. You can also use Siri voice control to make it easier to operate iPhone.

For details about CarPlay, visit <https://ssl.apple.com/ios/carplay/>.

### Compatible iPhone devices

You can use CarPlay with the following iPhone models.

- iPhone 5
- iPhone 5c
- iPhone 5s
- iPhone 6
- iPhone 6 Plus
- iPhone 6s
- iPhone 6s Plus

## Preparation

- 1 Press the **DNX8/7** <MENU> button/ **DNX5/E** volume knob.**

Popup menu appears.

- 2 Touch [SETUP].**

SETUP Menu screen appears.

- 3 Touch [AV].**

AV screen appears.

- 4 Set each item as follows.**



### Automotive Mirroring

Select "ON" to use Apple CarPlay.  
"ON" (Default)/ "OFF"

### CarPlay Sidebar

Select the position of the control bar (left or right) shown on the touch panel.  
"Left" (Default)/ "Right"

- 5 Connect iPhone using KCA-iP103.**

When iPhone compatible with CarPlay is connected to the iPod terminal, the Bluetooth smartphone currently connected is disconnected.

- 6 Unlock your iPhone.**

## Operation buttons and available Apps on the home screen of CarPlay

You can use the Apps of the connected iPhone.

The items displayed and the language used on the screen differ among the connected devices.

To enter CarPlay mode, touch [Apple CarPlay] icon in the HOME screen.

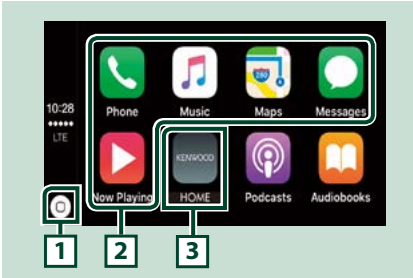

### 1 [ ]

- On the App screen: Displays the home screen of CarPlay.
- On the home screen of CarPlay: Touch and hold to activates Siri.

### 2 Application buttons

Starts the application.

### 3 [ HOME ]

Exits the CarPlay screen and displays the Home screen.

## To exit the CarPlay screen

- 1 Press the <HOME> button.

## Using Siri

You can activate Siri.

- 1 Press the <> button for 1 second.

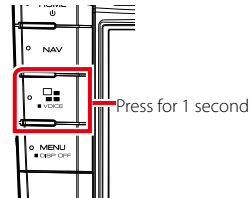
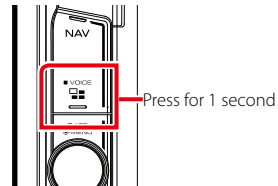
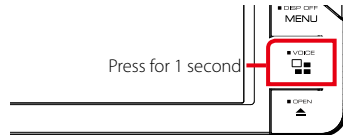
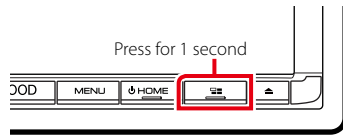

- 2 Talk to Siri.

## To deactivate

- 1 Press the <> button.

## Android Auto™ Operation (DNX8 DNX7 DNX516DABS)

Android Auto enables you to use functions of your Android device convenient for driving. You can easily access route guidance, make calls, listen to music, and access convenient functions on the Android device while driving.

For details about Android Auto, visit <https://www.android.com/auto/> and <https://support.google.com/androidauto>.

### Compatible Android devices

You can use Android Auto with Android devices of Android version 5.0 (Lollipop) or later.

#### Note

- Android Auto may not be available on all devices and is not available in all countries or regions.

## Preparation

- 1 Press the <MENU> button.**  
Pop-up menu appears.
- 2 Touch [SETUP].**  
SETUP Menu screen appears.
- 3 Touch [AV].**  
AV screen appears.
- 4 Set [Automotive Mirroring] to [ON].**

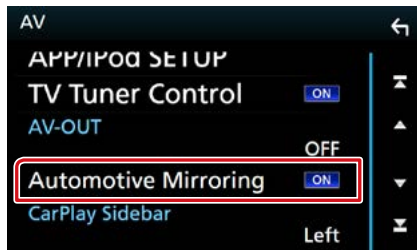

- 5 Connect an Android device via iPod/iPhone terminal.**

To use the hands-free function, connect the Android device via Bluetooth.

- When an Android device compatible with Android Auto is connected to the iPod/iPhone terminal, the device is connected via Bluetooth automatically, and the Bluetooth smartphone currently connected is disconnected.

- 6 Unlock your Android device.**

## Operation buttons and available Apps on the Android Auto screen

You can perform the operations of the Apps of the connected Android device.

The items displayed on the screen differ among the connected Android devices.

To enter Android Auto mode, touch [Android Auto] icon in the HOME screen.

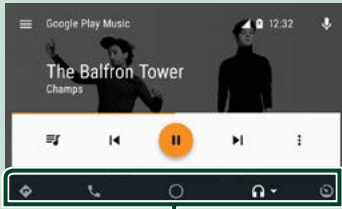

### 1 Application/information buttons

Starts the application or displays information.

### To exit the Android Auto screen

- 1 Press the <HOME> button.

## Using voice control

- 1 Press the <☰> button for 1 second.

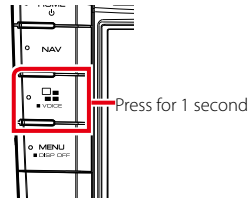
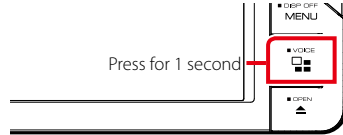
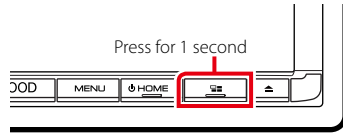

### To cancel

- 1 Press the <☰> button.

# Radio

## Radio Basic Operation

Most functions can be controlled from the source control screen.

To enter Radio source, touch [Radio] icon in the HOME screen.

### NOTE

- Set the remote control mode switch to AUD mode before starting operation, see [Switching the operation mode \(P.101\)](#).

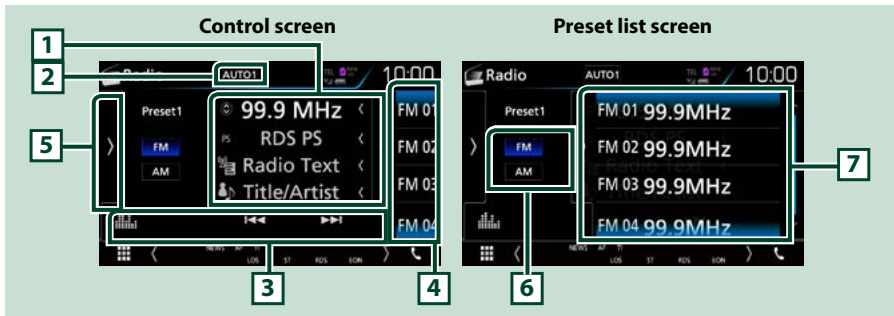

### 1 Information display

Displays the information of the current station: Frequency

Touching [↕] allows you to switch between Content A and Content B.

- Content A:** PS name, Radio Text, Title & Artist
- Content B:** PTY Genre, Radio Text plus

### 2 [AUTO1]/ [AUTO2]/ [MANUAL]

Switches the seek mode in the following sequence; [AUTO1], [AUTO2], [MANUAL].

- AUTO1:** Tunes in a station with good reception automatically.
- AUTO2:** Tunes in stations in memory one after another.
- MANUAL:** Switches to the next frequency manually.

### 3 Function bar

- [◀◀] [▶▶]: Tunes in a station. The method of frequency switching can be changed. (see 2 in table).
- [EQ]: Displays the Graphic Equalizer screen. [\(P.92\)](#)

### 4 Preset key

Recalls the memorized station.

Touching on the screen or flicking the screen to left will display the Preset list. Touching again or flicking to right will close the list.

### 5 Function panel

Touch on the left side of the screen to display the function panel. Touch again to close the panel. For details on the keys, see [Function panel \(P.53\)](#).

### 6 [FM] [AM]

Switches the band.

## 7 Preset list

Recalls the memorized station. When touched for 2 seconds, stores the current receiving station in memory.

### Function panel

#### 1 Touch on the left side of the screen.

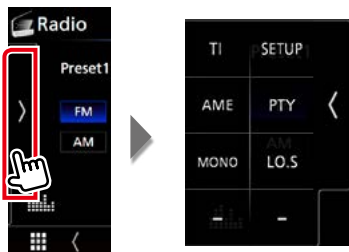

The functions of each key are as follows.

#### [TI] (FM Tuner only)

Sets the traffic information mode on. For details, see [Traffic Information \(P.58\)](#).

#### [SETUP]

Touch to display the Radio SETUP screen. For details, see [Radio Setup \(P.60\)](#).

#### [AME]

Presets stations automatically. For details, see [Auto memory \(P.56\)](#).

#### [PTY] (FM Tuner only)

Searches a program by setting program type. For details, see [Search by program type \(P.57\)](#).

#### [MONO] (FM Tuner only)

Select the Monaural reception.

#### [LO.S] (FM Tuner only)

Turns the Local Seek function on or off.

## Digital Radio Basic Operation (DNX8160DABS, DNX716WDABS, DNX5160DABS, DNX516DABS only)

Most functions can be controlled from the source control screen.

To enter Radio source, touch [DAB] icon in the HOME screen.

### NOTE

- Set the remote control mode switch to AUD mode before starting operation, see [Switching the operation mode \(P.101\)](#).

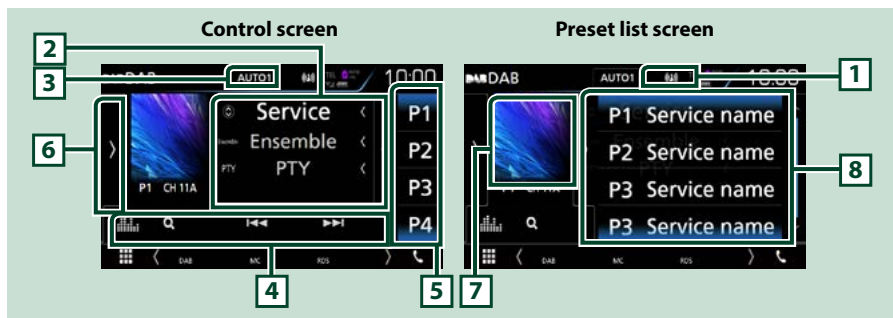

### 1 Indicator display

Displays the received signal strength.

### 2 Information display

Displays the information of the current station: Service Name

Touching [↕] allows you to switch between Content A, Content B and Content C.

- **Content A:** Ensemble name, PTY Genre
- **Content B:** Now Playing, Next Program
- **Content C:** Song Title, Artist Name, Audio Quality

### 3 [AUTO1]/ [AUTO2]/ [MANUAL]

Switches the seek mode in the following sequence; [AUTO1], [AUTO2], [MANUAL].

- **AUTO1:** Tunes in a ensemble with good reception automatically.
- **AUTO2:** Tunes in ensemble in memory one after another.
- **MANUAL:** Switches to the next ensemble manually.

### 4 Function bar

- [**◀▶▶▶**]: Tunes in a ensemble, service, and component. The seek mode switching can be changed. (see 3 in table).
- [**Q**]: Displays the Service List screen. For details on search operation, see [Service search \(P.58\)](#).
- [**📊**]: Displays the Graphic Equalizer screen. [\(P.92\)](#)

### 5 Preset key

Recalls the memorized service.

Touching on the screen or flicking the screen to left will display the Preset list. Touching again or flicking to right will close the list.

### 6 Function panel

Touch on the left side of the screen to display the function panel. Touch again to close the panel. For details on the keys, see [Function panel \(P.55\)](#).

## 7 Artwork area

The picture data is displayed if available from current content.  
Touch to switch between the Control and Information screen.

## 8 Preset list

Recalls the memorized service. When touched for 2 seconds, stores the current service in memory.

## Function panel

### 1 Touch on the left side of the screen.



The functions of each key are as follows.

#### [TI]

Sets the traffic information mode on. For details, see [Traffic Information \(P.58\)](#).

#### [SETUP]

Displays the DAB SETUP screen. For details, see [Digital Radio Setup \(P.61\)](#).

#### [Instant Replay] (Live mode only)

Change the Replay mode. See [Replay \(P.59\)](#).

#### [Live] (Replay mode only)

Change the Live mode.

#### [PTY] (Live mode only)

Searches a program by setting program type. For details, see [Search by program type \(P.57\)](#).

#### [DLS]

Display the Dynamic Label Segment screen.

## Information screen

### 1 Touch to switch between the Control and Information screen.

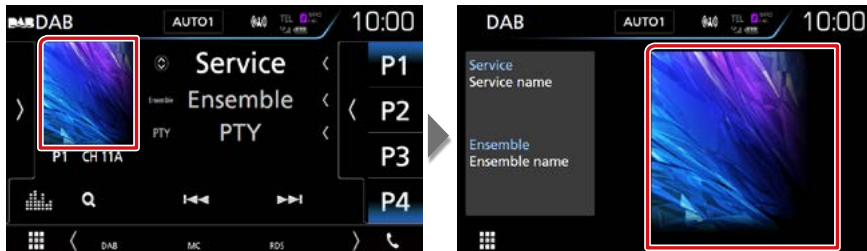



## Memory Operation

### Auto memory

You can store stations with good reception in memory automatically.

This function is for radio only.

#### 1 Touch desired band key.

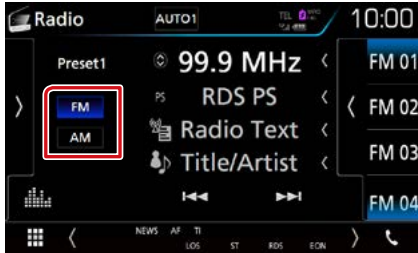

#### 2 Touch on the left side of the screen. Touch [AME].



#### 3 Touch [Yes].

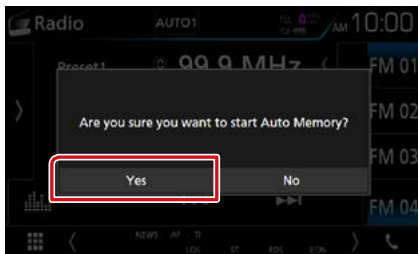

Auto memory starts.

### Manual memory

You can store the current receiving station or service in memory.

- 1 Select a station or service you wish to store in memory.
- 2 Touch [FM#] (#:1-15), [AM#] (#:1-5), or [P#] (#:1-15) in which you want to store the station for 2 seconds until a beep sounds.

## Selecting Operation

### Preset select

You can list and select memorized station or service.

#### Selecting from the preset list

**1 Touch on the right side of the screen.**

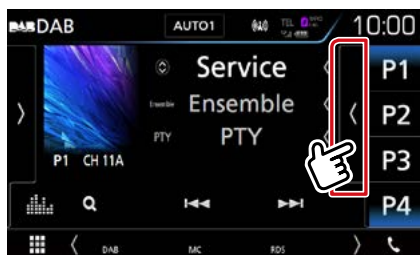

List Control screen appears.

**2 Select a station or service from the list.**



### Search by program type

You can tune to a station with a specific program type when listening to FM/ Digital Radio.

**1 Touch on the left side of the screen. Touch [PTY].**

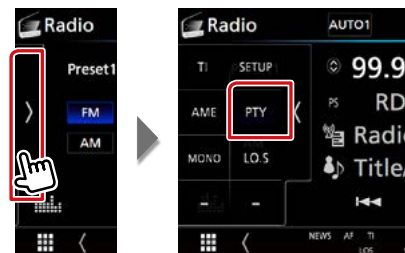

PTY Search screen appears.

**2 Select a program type from the list.**

**3 Touch [Search].**

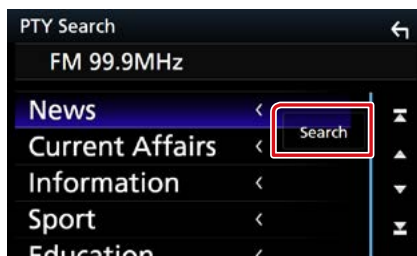

You can search a station of the selected program type.

## Service search (Digital Radio only)

You can select a service from a list of all services received.

### 1 Touch [Q].

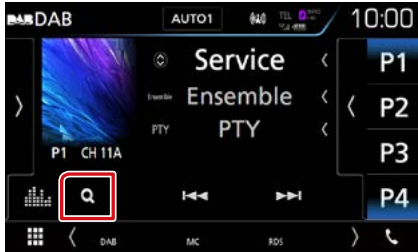

Service List appears.

### 2 Select the desired content from the list.

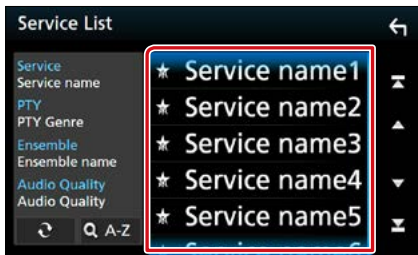

Touch and hold to find the latest service list.



Displays the keyboard screen.

Jump to the letter you entered (alphabet search).

## Traffic Information (FM Tuner and Digital Radio only)

You can listen and watch the traffic information automatically when a traffic bulletin starts.

However, this feature requires a Radio Data System and Digital Radio that includes the TI information.

### 1 Touch on the left side of the screen. Touch [TI].



Traffic information mode is set.

### When the traffic bulletin starts

The Traffic Information screen appears automatically.

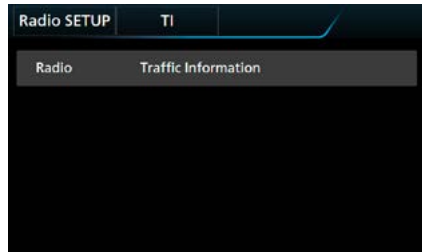

#### NOTE

- It is necessary to have Traffic Information function set to on in order to have the Traffic Information screen appear automatically.
- The volume setting during reception of traffic information is automatically stored. The next time the traffic information is received, this unit recalls the volume setting automatically.

## Replay (Digital Radio only)

You can replay last 30 minutes of current station.

- 1 Touch on the left side of the screen.  
Touch [Instant Replay].

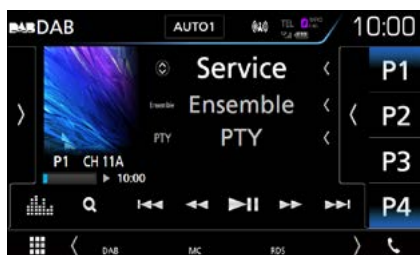

Forward/backward 15 seconds when touch it.



Plays or pauses.



Fast forward/fast backward when keep on touching. (It will be cancelled automatically after about 50 seconds.)

### Replay time bar

Display recorded capacity

### Function panel

Touch on the left side of the screen.



Change the Live mode

### NOTE

- PTY Watch starts operating and Replay function cannot be used while receiving a program.
- While replaying the current station, you can not store the station by [Manual memory \(P.56\)](#).

## Radio Setup

You can set tuner related parameters.

- 1 **Touch on the left side of the screen.**  
Touch [SETUP].



Radio SETUP screen appears.

- 2 **Set each item as follows.**

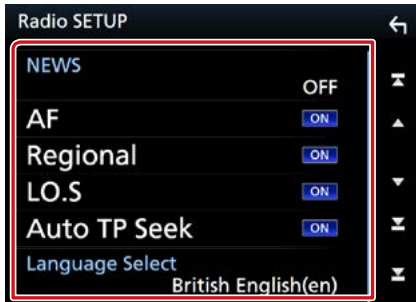

### NEWS

Sets a news bulletin interrupt time. Default is "OFF".

### AF

When station reception is poor, automatically switches to the station that is broadcasting the same program over the same Radio Data System network. Default is "ON".

### Regional

Sets whether to switch to the station only in the specific region using the "AF" control. Default is "ON".

### Auto TP Seek

When traffic information station reception is poor, automatically searches for a station that can be received better. Default is "ON".

### Language Select

Selects a display language for the PTY function.

## Digital Radio Setup

You can set Digital Radio related parameters.

- 1 Touch on the left side of the screen.  
Touch [SETUP].



Digital Radio SETUP screen appears.

- 2 Set each item as follows.



### Priority

If the same service is provided by Digital Radio during Radio Data System reception, automatically switches to Digital Radio. If the same service is provided by Radio Data System when reception of the service being provided by Digital Radio becomes poor, automatically switches to Radio Data System.

### PTY Watch

If the service of the set program type begins with the ensemble being received, switches from any source to Digital Radio for service reception.

### Announcement Select

Switches to the set Announcement service. For details, see [Announcement setup \(P.62\)](#).

### Seamless Blend

Prevents audio break when switching from Digital Radio to Analog Radio. Default is "ON".

### Antenna Power\*

Sets power supply to the Digital Radio antenna. Set to "ON" when the Digital Radio antenna in use is equipped with a booster. Default is "ON".

### L-Band Tuning

Sets L-band reception. When set to "ON", also receives L-band ensembles.

### Related Service

When you select ON, the unit switches to a related service (if exists) when a DAB service network is not available.

Default is "OFF".

\* This item can be set when in **STANDBY source**.

## Announcement setup

When the service for which ON is selected starts, switches from any source to Announcement to receive it.

**1 Touch [Announcement Select] in the DAB SETUP screen.**

The Announcement Select screen appears.

**2 Touch each Announcement list and set on or off.**



**NOTE**

- The volume setting during reception of Announcement service is automatically stored. The next time the Announcement service is received, this unit recalls the volume setting automatically.





# Bluetooth Control

Using the Bluetooth function, various functions can be used: listening to the audio file, making/receiving a call.

## About the cell-phone and Bluetooth audio player

This unit conforms to the following Bluetooth specifications:

### Version

Bluetooth Ver. 3.0

### Profile

Cell-phone:

HFP (V1.6) (Hands Free Profile)

SPP (Serial Port Profile)

HID (Human Interface Device Profile)

PBAP (Phonebook Access Profile)

GAP (Generic Access Profile)

Audio player:

A2DP (Advanced Audio Distribution Profile)

AVRCP (V1.5) (Audio/Video Remote Control Profile)

### Sound codec

SBC, AAC

### NOTE

- For the cell-phones verified for compatibility, access the following URL: <http://www.kenwood.com/cs/ce/bt/>.
- The units supporting the Bluetooth function have been certified for conformity with the Bluetooth Standard following the procedure prescribed by Bluetooth SIG. However, it may be impossible for such units to communicate with your cell-phone depending on its type.

## Registering and Connecting Bluetooth Unit

It is necessary to register the Bluetooth audio player or cell-phone to this unit before using the Bluetooth function.

You can register up to 10 Bluetooth units.

**1 Press the **DNX8/7** <MENU> button/ **DNX5/3** volume knob.**

Pop up menu appears.

**2 Touch [SETUP].**



SETUP Menu screen appears.

**3 Touch [Bluetooth].**



Bluetooth SETUP screen appears.

See the following section for each setting.

- **Registering from the Bluetooth unit** ([P.65](#))
- **Connecting the Bluetooth unit** ([P.66](#))
- **Change the PIN code** ([P.67](#))

## Registering from the Bluetooth unit

Follow the step 1, 2 and 3 for registration.

### Step 1: Registration from the Bluetooth device

- 1 Search the unit ("DNX\*\*\*\*") from your smartphone/cell-phone.
- 2 Input the PIN code in your smartphone/cell-phone.  
PIN code is set to "0000" as the default.

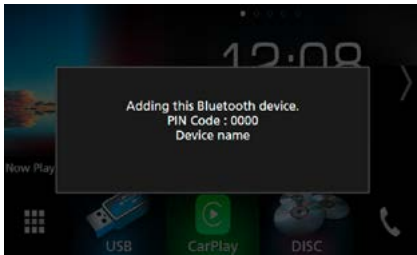

### SSP (Secure Simple Pairing of Bluetooth 2.1 or later)

- 1 Search the unit ("DNX\*\*\*\*") from your smartphone/cell-phone.
- 2 Confirm the request both on the smartphone/cell-phone and the unit.

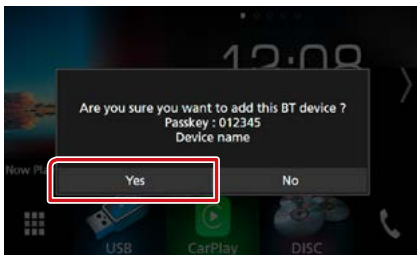

### NOTE

- A new device cannot be registered if there are 10 registered Bluetooth units. Delete unnecessary registration. See [Connecting the Bluetooth unit \(P.66\)](#).
- This unit is compatible with the Apple Easy Pairing function. When an iPod touch or iPhone is connected to this unit, an authentication dialog appears. Performing operation for authentication on this unit or iOS smartphone registers the smartphone as a Bluetooth device.

### Step 2: Connection settings

- 1 Select the hands-free number to connect.

A name of a smartphone is displayed when it has hands-free connection with the unit.

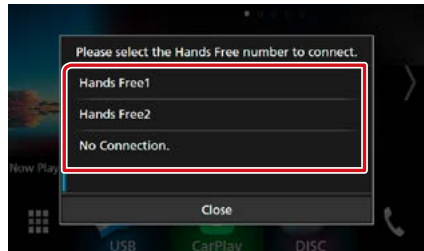

- 2 Select if you want to use the audio player app in your smartphone over A2DP, and the other apps in your smartphone over SPP.

This message appears if the device supports BT audio (A2DP) or smartphone link (SPP).

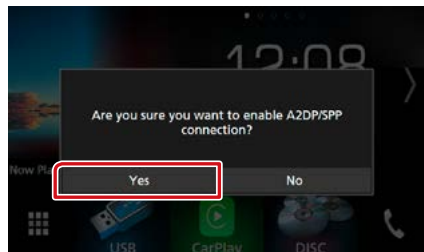

Continued

### Step 3: Phonebook transfer

#### 1 Select if you want to transfer your phonebook data.

This message appears if the device supports PBAP.

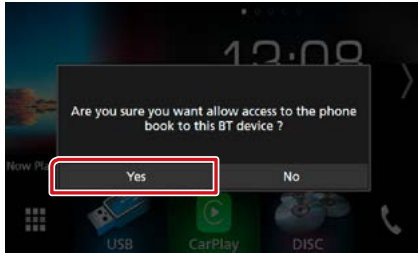

The phonebook data transmission starts. Some smartphones may request permission to access the data. The data transmission will start with your permission.



When the data transmission and connection have completed, the Bluetooth connection icon appears on the screen.

### Connecting the Bluetooth unit

#### 1 Touch [Select Device] in the Bluetooth SETUP screen.



#### 2 Touch the device name you want to connect.

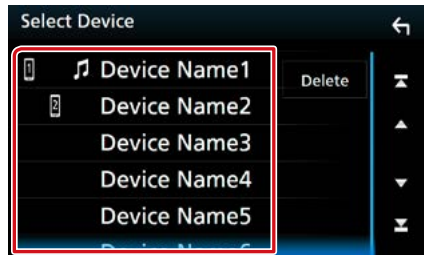

Profile select screen appears.

#### NOTE

- If the icon is lighted, it means that the unit will use that device.

#### 3 Set each profile as follows.

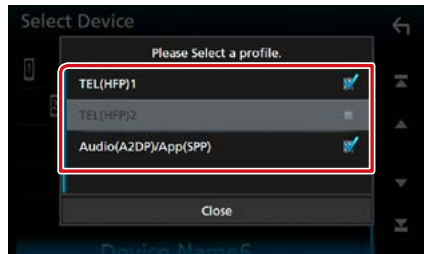

#### TEL (HFP) 1, TEL (HFP) 2

The device is connected with the unit as hands-free phone 1 or 2.

### Audio (A2DP)/App (SPP)

The device is connected with the unit as an audio player or as a smartphone with apps installed.

#### 4 Touch [Close].

#### NOTE

- If a device has been paired, the Bluetooth unit cannot be connected from the paired device.

### Deleting the registered Bluetooth unit

#### 1 Touch [Delete].

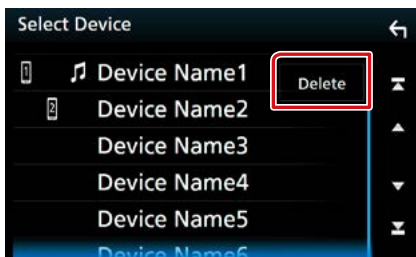

#### 2 Touch the device name to check.

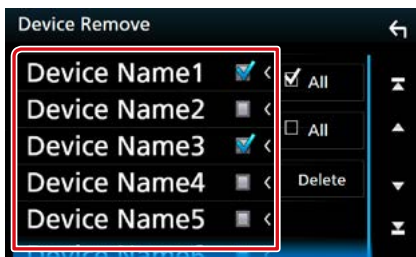

#### All

Select all Bluetooth unit.

#### All

Erases all check marks.

#### 3 Touch [Delete].

Confirmation message appears.

#### 4 Touch [Yes].

### Change the PIN code

#### 1 Touch [PIN Code] in the Bluetooth SETUP screen.

PIN Code Set screen appears.

#### 2 Input the PIN code



#### 3 Touch [SET].

### Change the device name

#### 1 Touch [Device Name] in the Bluetooth SETUP screen.

Change Device Name screen appears.

#### 2 Input the device name









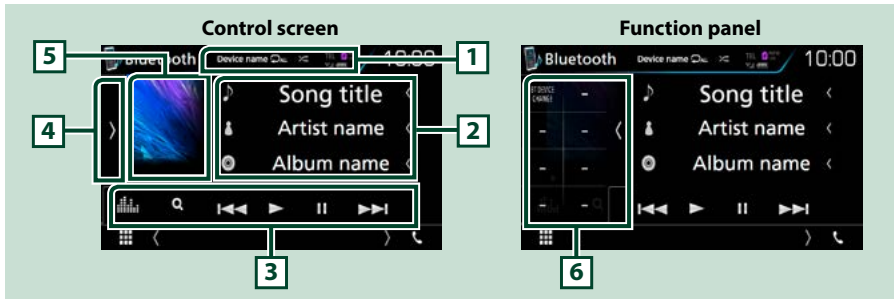

#### 3 Touch [Enter].

## Playing Bluetooth Audio Device

### Bluetooth basic operation









#### 1 Device name / [ ] / [ ]

- Connected device name.
- [  ] : Repeats the current track/folder. Each time you touch the key, repeat mode switches in the following sequence; File repeat (  ), Folder repeat (  ), All songs repeat (  ), Repeat off (  )
- [  ] : Randomly plays all tracks in current folder. Each time you touch the key, random mode switches in the following sequence; Folder random (  ), All random (  ), Random off (  )

#### 2 Information display \*

Displays the name of the track information.





#### 3 Function bar

- [  ] [  ]: Searches the previous/next content.\*
- [  ]: Plays.\*
- [  ]: Pauses.\*
- [  ]: Searches file.\* See [Folder search \(P.69\)](#).
- [  ]: Displays the Graphic Equalizer screen. [\(P.92\)](#)

#### 4 Function panel

Touch on the left side of the screen to display the function panel. Touch again to close the panel. For details on the keys, see [Function panel \(P.69\)](#).

#### 5 Play mode indicator

-  ,  : Current play mode indicator  
The meanings of each icon are as follows;  (play),  (pause).

#### 6 Function panel

Touch on the left side of the screen to display the function panel. Touch again to close the panel. For details on the keys, see [Function panel \(P.69\)](#).

\*These items appear **only when the audio player which supports AVRCP profile is connected.**

#### NOTE

- If the operation keys do not appear, operate from the player.
- Depending on your cell-phone or audio player, audio may be heard and controlled but text information may not appear.
- If the volume is too low, raise it on your cell-phone or audio player.

## Function panel

### 1 Touch on the left side of the screen.



The following functions can be performed by using keys in this area.

#### [BT DEVICE CHANGE]

Selects the device to connect via Bluetooth audio (A2DP) or APP (SPP). See [Connecting the Bluetooth audio \(P.69\)](#).

## Connecting the Bluetooth audio

Selects the device to connect via Bluetooth audio (A2DP) or APP (SPP).

### 1 Touch on the left side of the screen. Touch [BT DEVICE CHANGE].

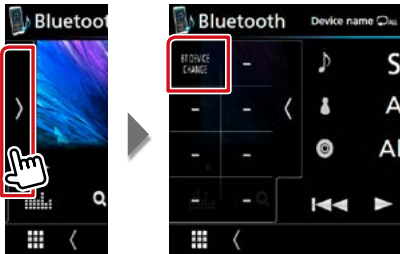

### 2 Touch the device name you want to connect.

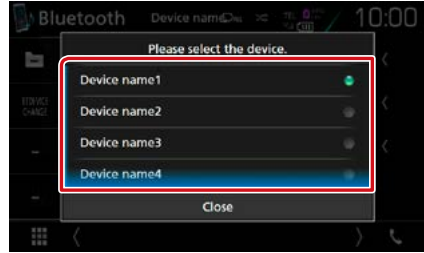

### 3 Touch [Close].

## Folder search

### 1 Touch [Q].

### 2 Touch the desired file or folder.

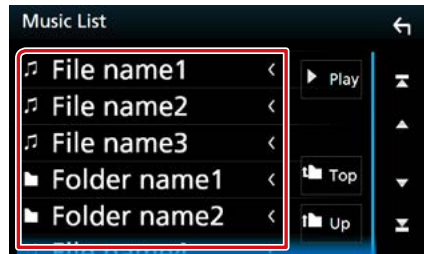

When you touch a folder its contents are displayed.

### 3 Touch desired item from the content list.

Playback starts.

#### NOTE

- For operations in the list screen, see [List screen \(P.25\)](#).

## Using Hands-Free Unit

You can use telephone function by connecting the Bluetooth telephone to this unit.

### Making a call

#### 1 Touch [☎].

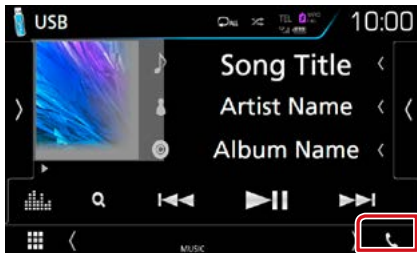

Hands Free screen appears.

#### NOTE

- If your mobile phone supports PBAP, you can display the phone book and call lists on the touch panel screen when the mobile phone is connected.
  - Phone book: up to 1000 entries
  - Dialed calls, received calls, and missed calls: up to 50 entries each

#### 2 Select a dialing method.



- [☰]: Call by entering a phone number
- [☎]: Call using call records
- [📖]: Call using the phonebook
- [★]: Call using the preset number
- [🗣️]: Voice Recognition ([P.73](#))

#### Select the cell-phone to use

When you connect two cell-phones

- ① Touch [ Device name1 Device name2 ] to select the phone you want to use.

#### Bluetooth SETUP

- ① Touch [🔗].  
Bluetooth SETUP screen appears.

#### NOTE

- The status icons such as battery and antenna displayed may differ from those displayed on the cell-phone.
- Setting the cell-phone in the private mode can disable the hands-free function.

**Call using call records**

- 1 Touch [  ].
- 2 Select the phone number from the list.

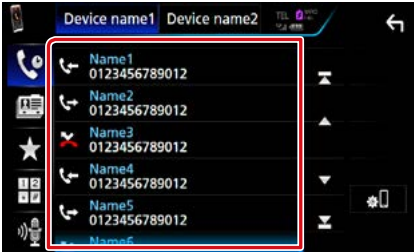
**Call by entering a phone number**

- 1 Touch [  ].
- 2 Enter a phone number with number keys.





- 3 Touch [  ].

**Call using the preset number**

- 1 Touch [  ].
- 2 Touch the Name or phone number.

**Call using the phonebook**

- 1 Touch [  ].
- 2 Touch [  ].
- 3 Select the initial.

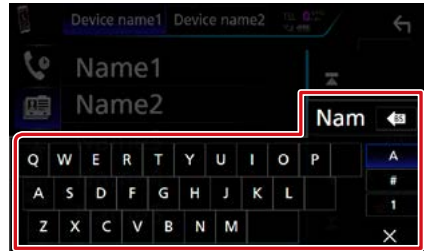

- Characters with no corresponding name will not appear.
- During search, a non-accent character such as "u" is searched for instead of an accent character such as "ü".

- 4 Select the person you want to call from the list.

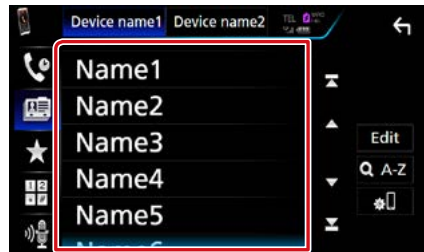



- 5 Select the phone number from the list.

**NOTE**

- You can set the list to arrange in the order of last name or first name. For details, see [Hands-Free Setup \(P.74\)](#).



## Receiving a call

- 1 Touch [  ] to answer a phone call or [  ] to reject an incoming call.

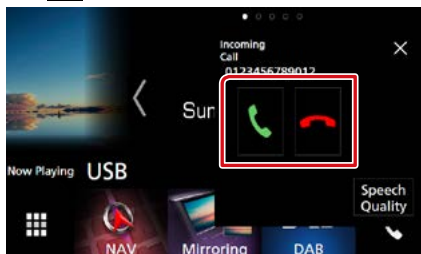

### NOTE

- While monitoring the view camera, this screen does not appear even if a call comes in. To display this screen, press the <TEL> button or return the shift knob of car to the driver position.

## Operations during a call

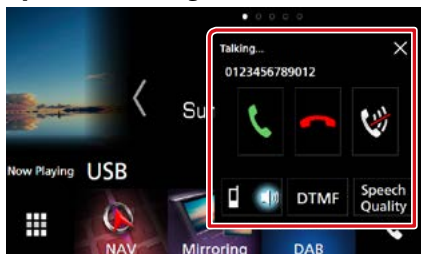

### Adjust the volume of your voice

- ① Touch [Speech Quality].
- ② Touch [◀] or [▶] of [Microphone Level].

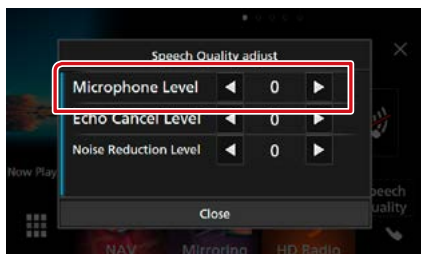

### Adjust the receiver volume

Press the <▼> or <▲> button.  
Turn the volume knob.

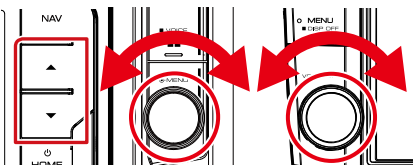



### Mute your voice

Touch [  ] to mute or not to mute your voice.

### Output the dial tone

Touch [DTMF] to display the tone input screen.  
You can send tones by touching desired keys on the screen.

### Switching the speaking voice output

Touching [  ] / [  ] each time switches the speaking voice output between cell-phone and speaker.

### Call-waiting

When you receive a call while talking on another call, you can answer the newly received call by touching [  ]. The current call is on hold.

Each time you touch [  ], the caller will change.

When you touch [  ], the current call will end and switch to the call in hold.

### [ × ]

The Hands-Free popup screen is closed. To display it again, touch [  ].

## Phone number preset

You can register frequently used phone numbers to this unit.

- 1 Touch [★].
- 2 Touch [Edit].



- 3 Select where to preset.



- 4 Select how to preset.

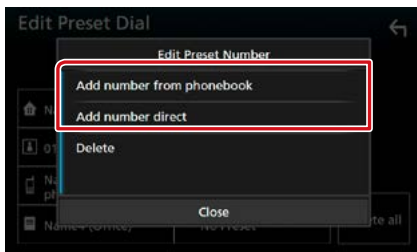

- [Add number from phonebook]: Select the number to preset by referring to "Call using the phonebook". See [Call using the phonebook \(P.71\)](#).
- [Add number direct]: Enter the telephone number directly and touch [SET]. See [Call by entering a phone number \(P.71\)](#).

### NOTE

- To delete the preset number, touch [Delete] and then touch [YES] on the confirmation screen.

## Voice Recognition

You can access the voice recognition function of the cell-phone connected to this unit. You can search the cell-phone phonebook by voice. (The functionality depends on the cell-phone.)

- 1 Press the <☰> button for 1 second.

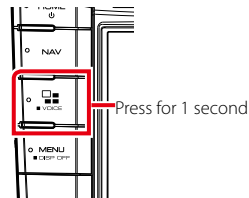
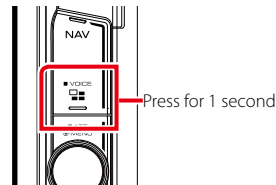
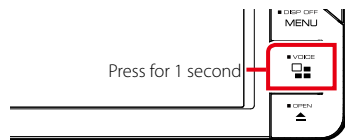
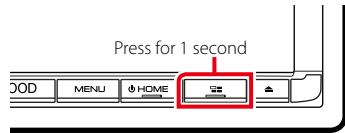

Voice Recognition screen appears.

- 2 Start speaking.

### NOTE

- You can use voice recognition function by touching [☰] on the Hands Free screen.

## Phonebook transfer

You can transfer the phonebook in your Bluetooth smartphone via PBAP.

1 Touch [  ].

2 Touch [Edit].



3 Touch [Add to Phonebook].

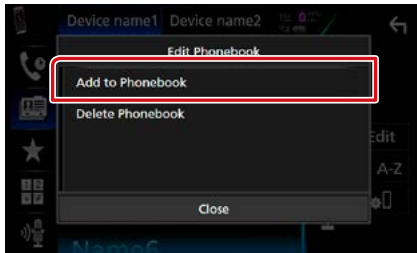

The phonebook data transmission starts.

## Phonebook deletion

1 Touch [  ].

2 Touch [Edit].



3 Touch [Delete Phonebook].

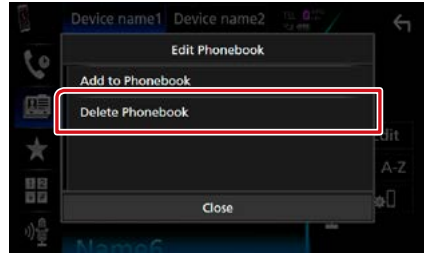

4 Touch the name to check.

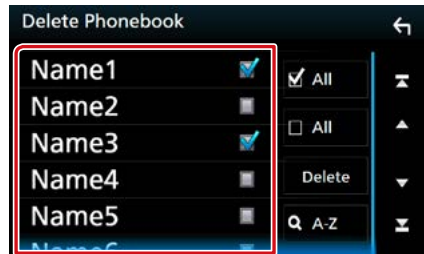

All

Checks all boxes.

All

Erases all check marks.

5 Touch [Delete].

Confirmation message appears.

6 Touch [Yes].

## Hands-Free Setup

You can perform various setup about handsfree function.

1 Press the **DNX8/7** <MENU> button/  
**DNX5/3** volume knob.

Popup menu appears.

2 Touch [SETUP].



SETUP Menu screen appears.

### 3 Touch [Bluetooth].



Bluetooth SETUP screen appears.

### 4 Touch [TEL SETUP].



TEL SETUP screen appears.

### 5 Set each item as follows.

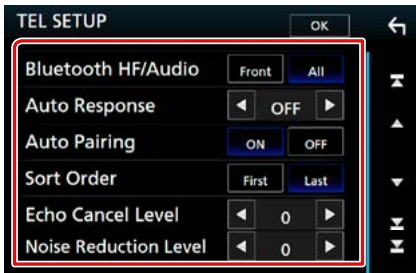

#### Bluetooth HF/Audio

Select the speakers to output the sound from cell-phone (such as phone call voice and ringing tone) and Bluetooth audio player.

**Front:** Outputs from the front speakers.

**All (Default):** Outputs from all speakers.

#### Auto Response\*

Sets an automatic response time to pick-up an incoming call.

**OFF (Default):** Automatic response is not available.

**1/ 5/ 10/ 15/ 20/ 25/ 30:** Set calling ring time (second).

#### Auto Pairing

When set to "ON", the Apple Auto Pairing function is turned on to automatically register the iPod touch or iPhone connected to this unit.

**ON (Default):** Uses Apple Auto Pairing function.

**OFF:** Not uses Apple Auto Pairing function.

#### Sort Order

Sets how to arrange the cell-phone phonebook.

**First:** Arranges in the order of first name.

**Last (Default):** Arranges in the order of last name.

#### Echo Cancel Level

Adjusts the level of echo cancellation.

Default is "0".

#### Noise Reduction Level

Reduces the noises generated by surrounding environment without changing the microphone volume. Use this setting when the voice of caller is not clear. Default is "0".

**\* Either the time interval for automatic answer set on this unit or the time interval set on the cell-phone, whichever is shorter takes effect.**

### 6 Touch [OK].

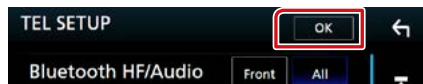

# Setting Up

## Monitor Screen Setup

You can adjust image quality in video, menu screen, etc.

**1** Press the **DNX3/7** <MENU> button/**DNX5/9** volume knob.

Pop up menu appears.

**2** Touch [Screen Adjustment].

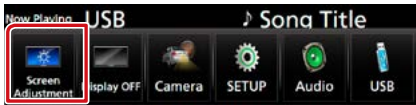

Screen Control screen appears.

**3** Adjust each item as follows.

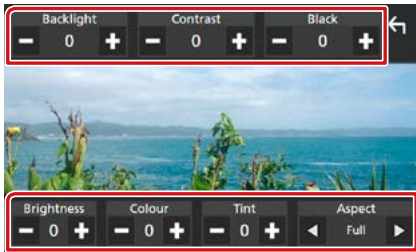

### Backlight / Contrast / Black / Brightness / Color / Tint

Adjusts each item.

### Aspect

Select screen mode.

**Full:** Changes the aspect ratio of video and displays fully on the screen.

**Normal:** Displays with 4:3 ratio.

**Auto:**

DVD, VCD and disc media: Video of 16:9 ratio is displayed in Full and video of 4:3 ratio is displayed in Regular.

USB device and SD card: Displays video fully on vertical or horizontal with no ratio change.

### NOTE

- Adjusting items are different depending on the current source.
- The image quality can be set for each source. Backlight and Black are common to all sources.

## Monitor Angle Control

### DNX8 DNX7

You can adjust the position of the monitor.

- 1 Press the **<▲>** button.  
Angle Adjust screen appears.
- 2 Select a below number that represents your desired angle setting.  
Default is "0".

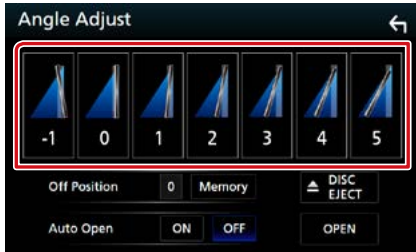

### Off Position

You can store the current monitor angle as the angle during power off. Touch [Memory] when the desired angle is selected.

It is effective when "Auto Open" is set to OFF.

### Auto Open (DNX8160DABS)

The front panel can be set to open automatically when the ignition is turned off, so that it can be detached for antitheft purpose.

## View Camera Control

You can select the front or rear view camera.

- 1 Press the **DNX8/7 <MENU>** button/**DNX5/E** volume knob.  
Pop up menu appears.
- 2 Touch [Camera].



View camera screen appears.

- 3 Adjust each item as follows.

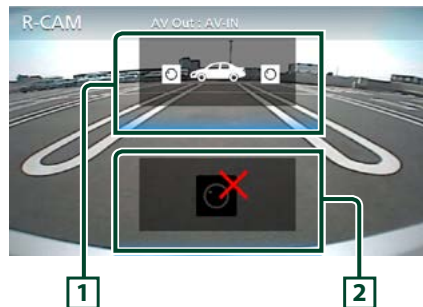

### 1 Switching the View Camera

Touching each time changes between the front view camera and rear view camera.

### 2 Camera off

Touch to exit the camera screen.

## System Setup

### NOTE

- Each operation in this section can be started from the multi function menu.

### 1 Press the **DNX8/7** <MENU> button/ **DNX5/3** volume knob.

Popup menu appears.

### 2 Touch [SETUP].



SETUP Menu screen appears.

See the following section for each setting.

- Set up the user interface [\(P.78\)](#)
- Set up special [\(P.81\)](#)
- Set up security [\(P.82\)](#)
- Set up display [\(P.83\)](#)
- Set up camera [\(P.85\)](#)
- Set up navigation [\(P.86\)](#)
- Set up AV [\(P.87\)](#)

## User Interface Setup

You can setup user interface parameters.

### 1 Press the **DNX8/7** <MENU> button/ **DNX5/3** volume knob.

Popup menu appears.

### 2 Touch [SETUP].



SETUP Menu screen appears.

### 3 Touch [User Interface].



User Interface screen appears.

### 4 Set each item as follows.



### Steering Remote Controller

Sets the desired function in the steering remote controller. (Contact your KENWOOD dealer for details.)

### Beep

Turns the key touch tone on or off.  
Default is "ON".

### Vehicle Adaptor Information\*<sup>1</sup>

Displays the vehicle information.  
This function requires a commercial adaptor.  
Consult your KENWOOD dealer for details.

### Beep for Parking distance control\*<sup>1</sup>

Sets whether to generate a warning tone when the onboard proximity sensor detects a human or object.  
Consult your KENWOOD dealer for details.

### Parking Distance Display\*<sup>1</sup>

You can display information about obstacles around the car.  
**ON:** Always displays information.  
**Dyn. (Default):** Displays information when the sensor detects obstacles.  
**OFF:** Cancels.

This function requires a commercial adaptor.  
Consult your KENWOOD dealer for details.

### Parking Distance Position\*<sup>1</sup>

Select where information about obstacles is displayed on the screen (left or right).  
"Left"/"Right" (Default)  
This function requires a commercial adaptor.  
Consult your KENWOOD dealer for details.

### Language Select Mode

Selects the mode to select a language.  
**Easy (Default):** Selects a language easily.  
**Advanced:** Allows you to select languages for respective items.\*<sup>2</sup>

### Language Select

Selects a language.

### Touch Panel Adjust (DNX7) / (DNX5B)

Adjust the sensing position of touch panel.  
[\(P.80\)](#)

### Clock

**NAV-SYNC (Default):** Synchronizes the clock time with navigation.  
**Manual:** Sets the clock manually

### Time Zone

If you have selected [Manual] for Clock, select the time zone.

### Clock Adjust

If you select [Manual] for Clock, adjust the date and time manually. [\(P.80\)](#)

**\*1 This setting is available when a commercial adaptor is connected.**

**\*2 If you select [Advanced] for Language Select Mode, the following screen appears.**

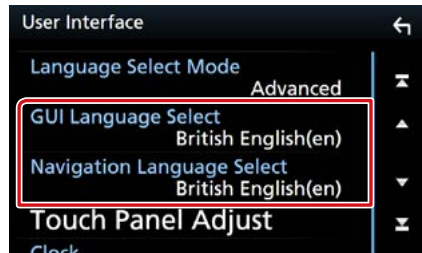

### GUI Language Select

Selects the display language used for the control screen and so forth.

### Navigation Language Select

Selects the language used for navigation.



## Setting Up

### Adjust the date and time manually.

#### 1 Touch [Clock Adjust] on the User Interface screen.

Clock Adjust screen appears.

#### 2 Adjust the date, then adjust the time.



#### 3 Touch [Set].

### Touch panel adjustment (~~DNX7~~ / ~~DNX5E~~)

#### 1 Touch [Touch Panel Adjust] on the User Interface screen.

Touch Panel Adjust screen appears.

#### 2 Follow the instruction on the screen and touch the center of each .



#### NOTE

- To cancel the touch panel adjustment, touch [Cancel].
- To reset to the initial status, touch [Reset].

## Special Setup

You can setup Special parameters.

**1 Press the **DNX3/7** <MENU> button/**DNX5/E** volume knob.**

Pop-up menu appears.

**2 Touch [SETUP].**

SETUP Menu screen appears.

**3 Touch [Special].**



Special screen appears.

**4 Set each item as follows.**



### DEMO

Set the demonstration mode. Default is "ON".

### SETUP Memory

Locks or unlocks the Audio SETUP Memory/ Recall/Clear.

### Audio SETUP Memory

Memorizes the current audio setting.

- Speaker / X'over, Equalizer, Position/DTA, Sound Effect [\(P.88\)](#)

### Audio SETUP Recall

Recalls the memorized audio setting.

### Audio SETUP Clear

Clears the AUDIO SETUP Memory and the currently memorized audio setting.

### Software Information

Check the software version of this unit.  
[\(P.81\)](#)

### Open Source Licenses

Displays the open source licenses.

### Initialize

Touch [Initialize] and then touch [Yes] to set all the settings to the initial default settings.

- Audio SETUP Memory is not initialized.

## Software Information

Check the software version of this unit.

**1 Touch [Software Information] in the Special screen.**

Software Information screen appears.

**2 Confirm the software version.**

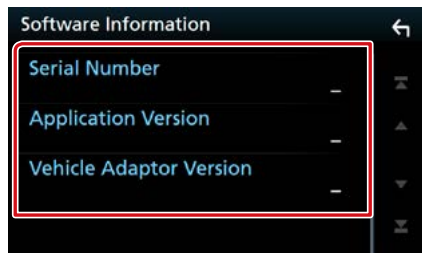

### NOTE

- For how to update the software, see the relevant update procedure manual which comes with the software.

## Security Setup

You can set up a security code to protect your receiver system against theft.

- 1 Press the **DNX3/7 <MENU> button/ DNX5/E volume knob.**

Popup menu appears.

- 2 Touch **[SETUP]**.

SETUP Menu screen appears.

- 3 Touch **[Security]**.

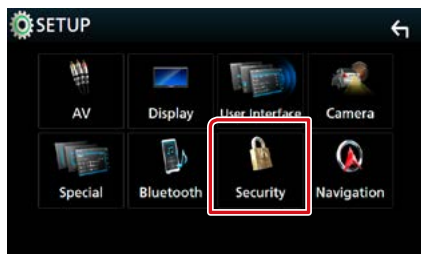

Security screen appears.

- 4 Set each item as follows.

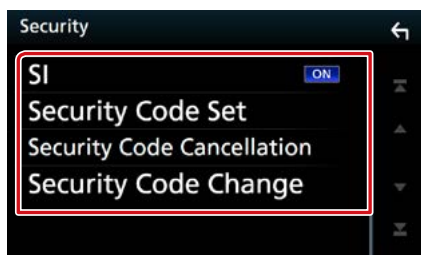

### SI \*1

A red indicator will blink on the unit after the ACC is set to OFF, warning potential thieves. If turned to "ON" (default), the security indicator on the front panel flashes when the vehicle ignition is off.

#### Security Code Set

Register the security code for the unit.

#### Security Code Cancellation

Clear the security code.

#### Security Code Change

Change the security code.

\*1 Except DNX716WDABS

## Security Code

When the Security Code function is activated, the code cannot be changed and the function cannot be released. Note the Security Code can be set as 4 to 8-digit number of your choice.

- 1 Touch **[Security Code Set]** on the Security screen.

Security Code Set screen appears.

- 2 Enter a security code with 4 to 8-digit number and touch **[Enter]**.

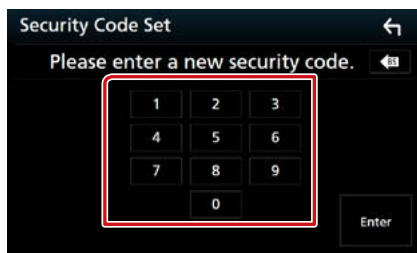

- 3 Enter the same code again and touch **[Enter]**.

Now, your security code is registered.

### NOTE

- Touch [BS] to delete the last entry.
- If you enter a different security code, the screen returns to step 2 (for the first code entry).
- if you have disconnected the Receiver from battery, enter the correct security code as that you have entered in step 2 and touch [Enter]. You can use your receiver.

### To change the security code:

- 1 Touch **[Security Code Change]** on the Security screen, then repeat step 2 and 3.

### To clear the security code:

- 1 Touch **[Security Code Cancellation]** on the Security screen.

## Display Setup

- 1 Press the **DNX6/7** <MENU> button/**DNX5/8** volume knob.

Popup menu appears.

- 2 Touch **[SETUP]**.

SETUP Menu screen appears.

- 3 Touch **[Display]**.



Display screen appears.

- 4 Set each item as follows.

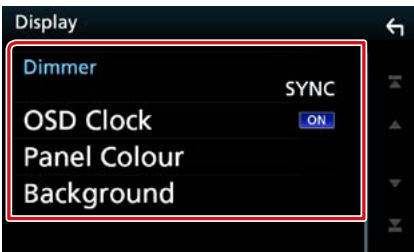

### Dimmer

Select dimmer mode.

**OFF:** The display and buttons do not dim.

**ON:** The display and buttons dim.

**SYNC (Default):** Turns the dimmer function on or off when the vehicle light control switch is turned on or off.

**NAV-SYNC:** Turns the dimmer function on or off according to the Navigation Day/Night display setting.

### OSD Clock

Select if you want to display the clock while watching DVD video, etc.

"ON" (Default)/ "OFF"

### Panel Color

You can set the screen and button illumination color. [\(P.83\)](#)

### Background

Changing background image. [\(P.84\)](#)

## Panel color coordinate

You can set the screen and button illumination color.

The selectable items differ depending on the unit.

- 1 Touch **[Panel Color]** in the **Display screen**.

Panel Color Coordinate screen appears.

- 2 Touch the desired color.



### User

The color you have set in the process of [Adjust] is registered.

### Scan

You can set the panel color to continuously scan through the color spectrum.

- 3 Touch **[←]**.

## Setting Up

### Registering original color

You can register your original color.

- 1 Touch [User] in the Panel Color Coordinate screen.
- 2 Touch [Adjust].  
Panel Color RGB Coordinate screen appears.
- 3 Use [-] and [+] to adjust each color value.



- 4 Touch [←].

### Changing background image

- 1 Touch [Background] in the Display screen.  
Background screen appears.
- 2 Select an image.



#### NOTE

- \*1 The color you have selected at [Panel Color] is added on the image. If you select "Scan" at [Panel Color], you cannot select this image.

### Registering original image

You can load an image from the connected USB device and set it for the background image.

Before operating this procedure, it is necessary to connect the device which has the image to load.

- 1 Touch [User1 Select] or [User2 Select] in the Background screen.  
User Background File Select screen appears.
- 2 Select the image to load.



- 3 Touch [Enter].

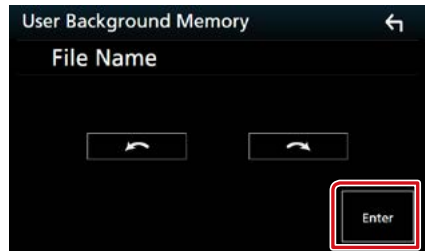

The selected image is loaded and the display returns to the Background screen.

#### NOTE

- Touching [↻] rotates counter clockwise.
- Touching [↻] rotates clockwise.

#### NOTE

- See [Playable Media and Files \(P.108\)](#) for readable image specifications.

## Camera Setup

You can set camera parameters.

**1** Press the **DNX8/7** <MENU> button/  
**DNX5/E** volume knob.

Popup menu appears.

**2** Touch **[SETUP]**.

SETUP Menu screen appears.

**3** Touch **[Camera]**.



Camera screen appears.

**4** Set each item as follows.

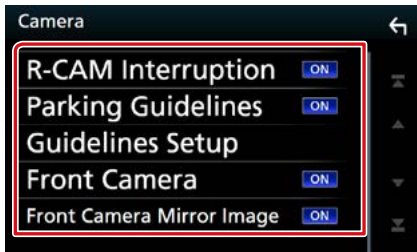

### R-CAM Interruption

**ON:** Displays the picture from the rear view camera when you shift the gear to the reverse (R) position.

**OFF (Default):** Select this when no camera is connected.

### Parking Guidelines

You can display parking guidelines to enable easier parking when you shift the gear to the reverse (R) position.

Default is "ON".

### Guideline Setup

If you select [ON] for Parking Guidelines, adjust the parking guidelines. See [Adjusting the parking guidelines \(P.86\)](#).

### Front Camera **DNX8** **DNX7** **DNX5**

**On:** Activates the front view camera. Select this to use the front view camera.

**OFF (Default):** Select this when no camera is connected.

### Front Camera Mirror Image **DNX8** **DNX7** **DNX5**

If you select [ON] for Front Camera.

**On:** Displays the picture from the front view camera horizontally reversed.

**OFF (Default):** Displays the picture from the front view camera as it is.

### Adjusting the parking guidelines

- 1 Touch [ON] of [Parking Guidelines] in the Camera screen.
- 2 Touch [Guideline Setup] in the Camera screen.
- 3 Adjust the parking guidelines by selecting the  mark.



- 4 Adjusting the position of the selected  mark.

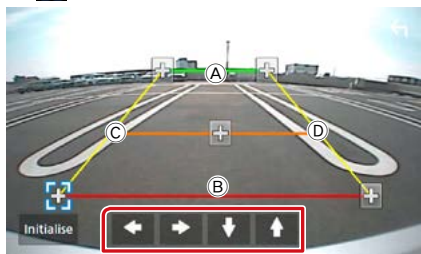

Make sure that (A) and (B) are horizontally parallel, and that (C) and (D) are the same length.

#### NOTE

- Touch [Initialize] and after touch [Yes] to set all the  marks to the initial default position.

## Navigation Setup

You can set navigation parameters.

- 1 Press the **DNX8/7** <MENU> button/**DNX5/E** volume knob.  
Popup menu appears.
- 2 Touch [SETUP].  
SETUP Menu screen appears.
- 3 Touch [Navigation].



Navigation SETUP screen appears.

- 4 Set each item as follows.



#### NAV Mute

Mutes the volume of rear speakers during voice guidance of the navigation system. Default is "ON".

#### NAV Interrupt Speaker

Selects speakers used for voice guidance of the navigation system.

**Front L:** Uses the front left side speaker for voice guidance.

**Front R:** Uses the front right side speaker for voice guidance.

**Front All (Default):** Uses both front speakers for voice guidance.

#### NAV Voice Volume

Adjusts the volume for voice guidance of the navigation system. Default is "24".

## AV Setup

You can set AV parameters.

**1** Press the **DNX3/7** <MENU> button/**DNX5/E** volume knob.

Popup menu appears.

**2** Touch **[SETUP]**.

SETUP Menu screen appears.

**3** Touch **[AV]**.



AV screen appears.

**4** Set each item as follows.

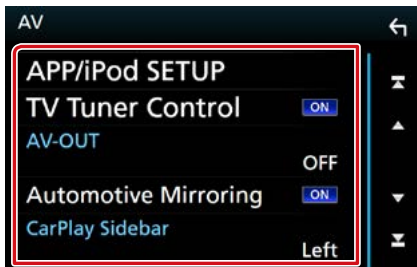

### APP/iPod SETUP

Set up APP/iPod connection. See [APP/iPod settings \(P.35\)](#).

### TV Tuner Control (except DNX3160BT)

Sets when connecting the TV tuner to AV INPUT.

**ON:** Set to ON when connecting the 3rd party TV tuner. AV-IN1 Name is set to TV. If you connect the TV tuner made by DOS and watch TV, you can perform some simple operations by touching the screen of this unit.

**OFF (Default):** Set to OFF when not connecting the 3rd party TV tuner.

### AV-OUT

You can select an AV source to be output from the AV OUTPUT port.

OFF, AV-IN, AV-IN1, AV-IN2, DISC, USB, SD, or iPod

- You cannot select iPod if it is connected via Bluetooth.
- If you select USB, SD, iPod, Disc, Mirroring, Bluetooth audio, Apple CarPlay or Android Auto as the main source, you cannot select USB, SD or iPod as the AV output source.

### Automotive Mirroring

Select "ON" to use Apple CarPlay or Android Auto.

"ON" (Default)/ "OFF"

### CarPlay Sidebar

Select the position of the control bar (left or right) shown on the touch panel.

"Left" (Default)/ "Right"



# Controlling Audio

**NOTE**

- Each operation in this section can be started from the multi function menu.

You can adjust the various settings such as audio balance or subwoofer level.

**1 Press the **DNX8/7** <MENU> button/ **DNX5/3** volume knob.**

Popup menu appears.

**2 Touch [Audio].**



Audio screen appears.

See the following section for each setting.

- **Set up speakers** [\(P.88\)](#)
- **Controlling audio** [\(P.91\)](#)
- **Controlling equalizer** [\(P.92\)](#)
- **Performing zone control** [\(P.94\)](#)
- **Set sound effect** [\(P.95\)](#)
- **Set volume offset** [\(P.93\)](#)
- **Set listening position** [\(P.96\)](#)

## Speaker/ X'over setup

**1 Press the **DNX8/7** <MENU> button/ **DNX5/3** volume knob.**

Popup menu appears.

**2 Touch [Audio].**



Audio screen appears.

**3 Touch [Speaker/X'over].**

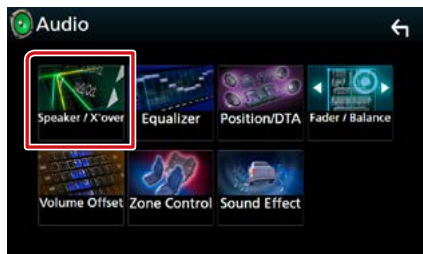

Speaker Select screen appears.

**4 Touch the speaker you wish to adjust and set each item as follows.**



### Car Type

You can setup the car type and speaker network, etc.

### Speaker

You can select a speaker type and its size to get the best sound effects.

When the speaker type and size are set, the speaker crossover network is set automatically.

**Location (Only for Front, Rear)**

Select the speaker position you have fixed.

**Tweeter (Only for Front)**

You can set the tweeter when you are selecting front speakers.

None, Small, Middle, Large

**X'over**

Displays the speaker crossover setup screen.

You can adjust the crossover setup that was set automatically when you selected the speaker type.

For details, see [Crossover network setup \(P.90\)](#)

**5 Select a item.****Car Type**

**You can setup the car type and speaker network, etc.**

- If your car type is selected, the Delay Time Alignment is set automatically (for timing adjustment of sound output for each channel) to have the highest surround effects.

**Speaker****Front**

OEM, 8 cm, 10 cm, 12 cm, 13 cm, 16 cm, 17 cm, 18 cm, 4x6, 5x7, 6x8, 6x9, 7x10

**Rear**

None, OEM, 8 cm, 10 cm, 12 cm, 13 cm, 16 cm, 17 cm, 18 cm, 4x6, 5x7, 6x8, 6x9, 7x10

**Subwoofer**

None, 16 cm, 20 cm, 25 cm, 30 cm, 38 cm over

- Select "None" if you have no speakers.

**Location****Front**

Select the location from "Upper Door Area"/ "Lower Door Area"/ "On Dash"/ "Under Dash".

**Rear**

Select the location from "Upper Door Area"/ "Lower Door Area"/ "Upper Cargo Area"<sup>\*1</sup>/ "Lower Cargo Area"<sup>\*1</sup>/ "Upper 3rd Row Area"<sup>\*2</sup>/ "Lower 3rd Row Area"<sup>\*2</sup>/ "Parcel Shelf Area"<sup>\*3</sup>

\*1 "Compact"/ "Wagon"/ "SUV"

\*2 "Minivan"/ "Passenger Van"

\*3 "OFF"/ "Sedan"

### Crossover network setup

You can set a crossover frequency of speakers.

#### 1 Touch [X'over].



X'over screen appears.

#### 2 Touch the speaker to set.



#### 3 Set each item as follows.



#### HPF FREQ

High Pass Filter adjustment. (When front or rear speaker is selected on Speaker Select screen)

#### LPF FREQ

Low Pass Filter adjustment. (When subwoofer is selected on Speaker Select screen)

#### Slope\*3

Sets a crossover slope.

#### Gain

Adjusts the front speaker, rear speaker, or subwoofer level.

#### TW (Tweeter) Gain \*1

Adjusts the tweeter level. (When front is selected on Speaker Select screen)

#### Phase Inversion\*2

Sets the phase of subwoofer output.

Check [Phase Inversion] to shift the phase 180 degrees. (When subwoofer is selected on Speaker Select screen)

\*1 Only when "Tweeter" is set to "Small", "Middle", "Large" in <Speaker Setup>.

\*2 Only when "Subwoofer" is set to a mode other than "None" in <Speaker Setup>.

\*3 Only when "LPF FREQ"/"HPF FREQ" is set to a mode other than "Through" in <X'over>.

## Controlling General Audio

- 1 Press the **DNX6/7** <MENU> button/  
**DNX5/6** volume knob.

Popup menu appears.

- 2 Touch [Audio].



Audio screen appears.

- 3 Touch [Fader / Balance].

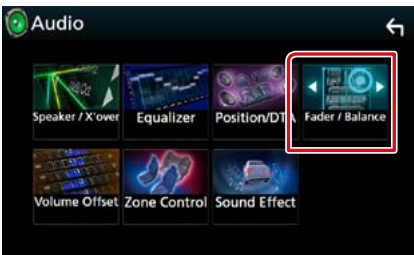

Fader / Balance screen appears.

- 4 Set each item as follows.

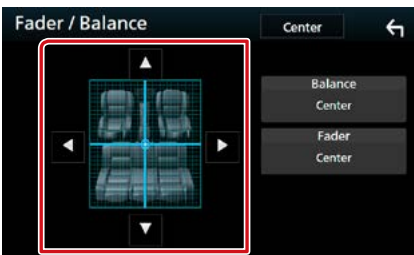

### Fader / Balance

Adjust the volume balance around the touched area.

[▶] and [◀] adjust the right and left volume balance.

[▲] and [▼] adjust the front and rear volume balance.

## Equalizer Control

You can adjust equalizer by selecting the optimized setting for each category.

**1** Press the **DNX8/7 <MENU>** button/**DNX5/3** volume knob.

Pop up menu appears.

**2** Touch [Audio].



Audio screen appears.

**3** Touch [Equalizer].

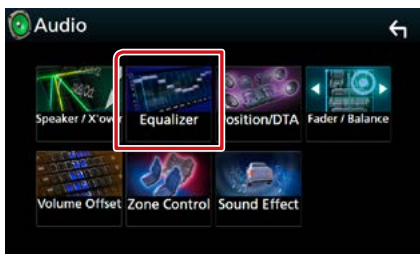

Equalizer screen appears.

**4** Touch the screen and set the **Graphic Equalizer** as desired.

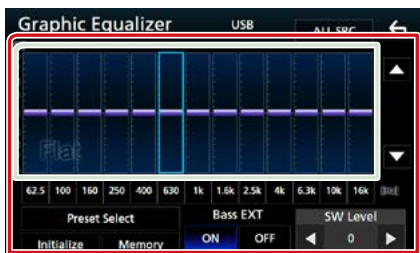

### Gain level (light green boxed area)

Adjust the gain level by touching the each frequency bar.

You can select frequency bar and adjust its level by [▲], [▼].

### Preset Select

Displays the screen to recall the preset equalizer curve.

### Memory

Saves the adjusted equalizer curve to "User1" to "User4".

### Initialize

The current EQ curve returns to flat.

### ALL SRC

Apply the adjusted equalizer to all sources. Touch [ALL SRC] and then touch [OK] on the confirmation screen.

### Bass EXT (Bass Extend Settings)

When turned on, the frequency lower than 62.5 Hz is set to the same gain level as 62.5 Hz.

### SW Level

Adjusts the subwoofer volume. This setting is not available when subwoofer is set to "None".

See [Speaker/ X'over setup \(P.88\)](#).

## Recall the EQ curve

**1** Touch [Preset Select].

**2** Select EQ curve.



### NOTE

- [iPod] is available only during iPod source.

## Save the EQ curve

- 1 Adjust the EQ curve.
- 2 Touch [Memory].
- 3 Select where to save.

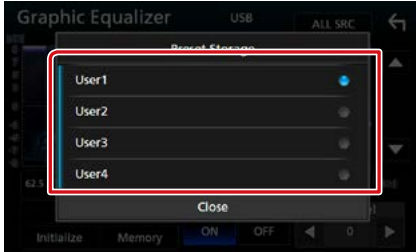

## Volume Offset

Finely adjust the volume of the current source to minimize the difference in volume between different sources.

- 1 Press the **DNX8/7** <MENU> button/**DNX5/3** volume knob.  
Pop up menu appears.

- 2 Touch [Audio].



Audio screen appears.

- 3 Touch [Volume Offset].

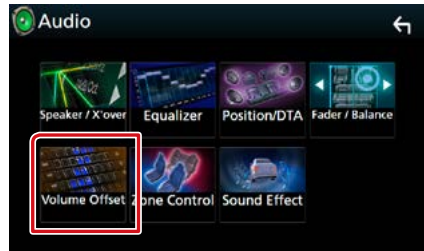

Volume Offset screen appears.

- 4 Touch [+ ] or [- ] to adjust the level.



## Initialize

Returns to the initial settings.

- \* If you have increased the volume first, then reduced the volume using the "Volume Offset", the sound generated if you suddenly switch to another source may be extremely loud.

## Zone Control

You can select different sources for both front and rear positions in the vehicle.

**1** Press the **DNX877** <MENU> button/**DNX55** volume knob.

Popup menu appears.

**2** Touch [Audio].



Audio screen appears.

**3** Touch [Zone Control].

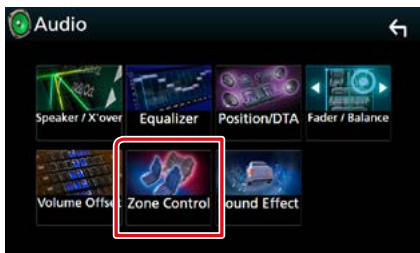

Zone Control screen appears.

**4** Touch [Zone Select].

**5** Touch [Dual Zone].

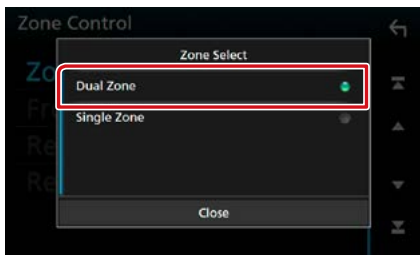

**6** Set each source as follows.



### [Zone Select]

Touch [Single Zone] to turn off the dual zone function.

### [Front Source] [Rear Source]

Select the audio source for each.

### [Rear VOL.]

Adjusts the rear channel volume.

### NOTE

- When the rear speaker sound is switched, the audio source that is output at the AV OUTPUT terminal is also switched to the same source.
- When the dual zone function is set to on, the following functions are not available.
  - Output from the subwoofer
  - Subwoofer Level/ Bass Boost ([P.95](#))
  - Equalizer Control/ Sound Effect/ Listening Position ([P.92, 95, 96](#))
  - Speaker Setup ([P.88](#))
- You cannot select iPod if it is connected via Bluetooth.
- If you select USB, SD, iPod, Disc, Mirroring, Bluetooth audio, Apple CarPlay or Android Auto as the Front Source, you cannot select USB, SD or iPod as the Rear Source.

## Sound Effect

You can set sound effects.

**1** Press the **DNX3/7** <MENU> button/  
**DNX5/9** volume knob.

Popup menu appears.

**2** Touch [Audio].



Audio screen appears.

**3** Touch [Sound Effect].

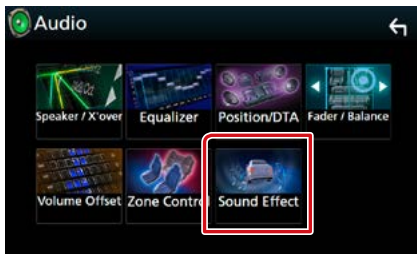

Sound Effect screen appears.

**4** Set each item as follows.



### Bass Boost

Sets the amount of bass boost among "OFF"/  
"1"/"2"/"3".

### Loudness

Sets the amounts of boost of low and high tones.

"OFF", "Low", "High"

### Drive Equalizer+

The sound quality is automatically optimized to meet the current car speed by GPS.

"OFF", "ON"

### Space Enhancer

Select the feeling of sound space enhancement.

"OFF"/"Small"/"Medium"/"Large".

### Supreme

Turns ON/OFF the Supreme function.

Technology to extrapolate and supplement with proprietary algorithm, the high-frequency range that is cut off when encoding.

### Realizer

Virtually makes the sound more realistic using the Digital Signal Processor (DSP) system.

Select the level from "OFF"/"1"/"2"/"3".

### Stage EQ

You can adjust the height of speakers virtually to suit your listening position.

"OFF"/"Low"/"Middle"/"High".



## Listening Position/ DTA

You can adjust the sound effects according to your listening position.

- 1 Press the **DNX3/7** <MENU> button/ **DNX5/3** volume knob.

Popup menu appears.

- 2 Touch [Audio].



Audio screen appears.

- 3 Touch [Position/DTA].

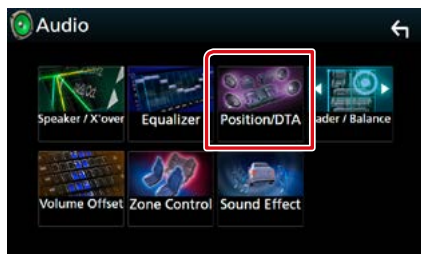

- Set up Listening Position ([P.96](#))
- Set up Front Focus ([P.98](#))

## Listening Position

Adjust the sound delay time as nearer speakers to the selected seat have more delay time, so that the sound from each speaker arrive a listener at the same time.

- 1 Touch [Listening Position] in the Position/DTA screen.
- 2 Select listening position from [Front R] (Right front), [Front L] (Left front), [Front All] (All front), and [All].



**Position DTA control**

You can fine-adjust your listening position.

- 1 Touch [Adjust].**
- 2 Touch [Delay].**
- 3 Touch [◀] or [▶] to adjust the delay time of the selected speaker.**



- 4 Touch [Level].**
- 5 Touch [◀] or [▶] to adjust the sound level of the selected speaker.**

**NOTE**

- To return to the initial setting of Delay and Level, touch [Initialize] and [YES] in the confirmation screen.

## Front Focus

This is the function to focus the imaginary sound image in front of the selected seat.

**1 Touch [Front Focus] in the Position/DTA screen.**

**2 Select a front focus position.**

For [Front All] and [All], select Priority L or R depending on which side you want to put the imaginary sound image.



## Front Focus fine adjustment

**1 Touch [Adjust].**

**2 Touch [Delay].**

**3 Set each item as follows.**



### Sound Image LR (Front)

Adjust the sound image to focus on in front of front seats.

### Sound Image LR (Rear)

Adjust the sound image to focus on in front of rear seats.

### Size of the Virtual Sound Field

Adjust the size of sound image to meet your taste. If the sound image is shifted from the front, adjust it by [Sound Image LR (Front)] or [Sound Image LR (Rear)].

### Subwoofer Delay

Adjust the delay time of subwoofer.

**4 Touch [Level].**

**5 Touch [◀] or [▶] to adjust the sound level of the selected speaker.**



**NOTE**

- To return to the initial setting of Delay and Level, touch [Initialize] and [YES] in the confirmation screen.

## Remote control

This unit can be operated using the remote control.  
The remote control is the optional accessory (KNA-RCDV331).

### ⚠ CAUTION

- Put the remote control in a place where it will not move during braking or other operations. A dangerous situation could result, if the remote control falls down and gets wedged under the pedals while driving.
- Do not leave the battery near fire or under direct sunlight. A fire, explosion or excessive heat generation may result.
- Do not recharge, short, break up or heat the battery or place it in an open fire. Such actions may cause the battery to leak fluid. If spilled fluid comes in contact with your eyes or on clothing, immediately rinse with water and consult a physician.
- Place the battery out of reach of children. In the unlikely event that a child swallows the battery, immediately consult a physician.

## Battery Installation

If the remote control operates only over shorter distances or does not operate at all, it is possible that the batteries are depleted.

In such instances, replace the both batteries with new ones.

- 1** Insert two "AAA"/"R03"-size batteries with the ⊕ and ⊖ poles aligned properly, following the illustration inside the case.

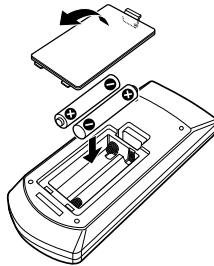

## Functions of the Remote control Buttons

### Switching the operation mode

The functions operated from the remote control differ depending on the position of the mode switch.

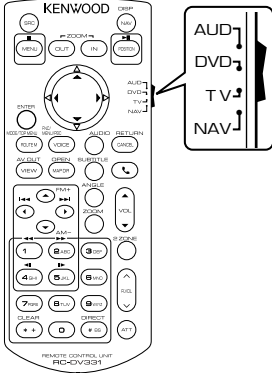

#### AUD mode

Switch to this mode when controlling a selected source or tuner source, etc.

#### DVD mode

Switch to this mode when playing a disc media including DVD, VCD, and CD.

#### NAV mode

Switch to this mode when controlling navigation function.

#### TV mode

Not used.

#### NOTE

- When controlling a player that is not integrated in the unit, select "AUD" mode.

### Direct search mode

Using the remote control, you can jump directly to the desired file, track chapter, etc. with entering the number corresponding to the content.

#### NOTE

- This operation cannot be performed for USB device and iPod.

### 1 Press the **<#BS>** button several times until the desired content appears.

The available contents are different depending on the source.

#### DVD

Title number/Chapter number

#### VCD 1.X and 2.X (PBC OFF)

Track number

#### VCD 2.X (PBC ON)

Scene number/Track number

#### Music CD

Track number

#### Radio

Frequency value

### 2 Enter the number of the content you want to play using the numeric keypad.



### 3 For DVD or VCD, music CD, press the **<ENTER>** button.

For radio, press the **<◀>** or **<▶>** button.

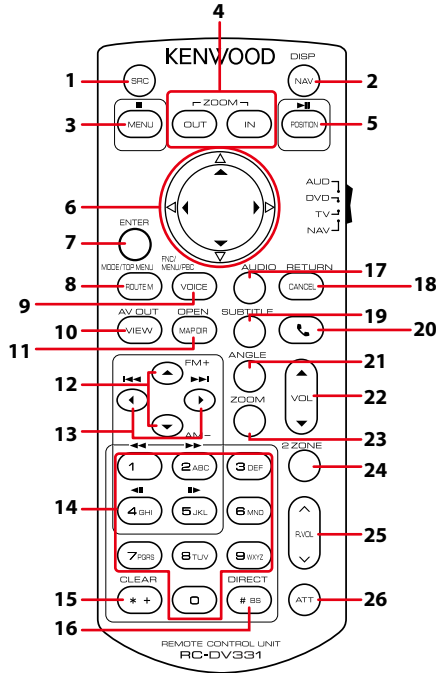
The content you entered is played.



	Key Name	Location of the mode switch	Function
1	SRC	AUD	Switches to the source to be played. In hands-free mode, hangs up the phone.
2	NAV	—	Switches between the navigation and the source screens.
3	MENU	DVD	Stops playing and memorizes the last point where the disc stopped. The last point is deleted by pressing twice.
		NAV	Displays Main menu.
4	OUT, IN	NAV	Zooms in or out the navigation map.
5	POSITION	AUD, DVD	Pauses the track or file, and resumes playing by pressing twice. During radio source in AUD mode, switches the seek mode.
		NAV	Displays the current position.
6	Cursor Key	DVD	Moves the cursor in the DVD menu.
		NAV	Moves the cursor or scrolls the map.
7	ENTER	AUD, DVD	Performs the selected function.
		NAV	<ul style="list-style-type: none"> <li>Registers the selected position.</li> <li>Performs the selected function.</li> </ul>
8	ROUTE M	AUD	Screen mode changes each time you press this key during video playback.
		DVD	Returns to the DVD top menu.
		NAV	Displays Route Option menu.

	Key Name	Location of the mode switch	Function
9	VOICE	AUD	Displays the control screen of current source. (USB/ SD/ iPod/ DISC)
		DVD	Displays the DVD menu. Turns the playback control on or off while playing VCD.
		NAV	Speaks the voice guidance.
10	VIEW	AUD, DVD	Switches the AV source to be output.
		NAV	Switches between 2D and 3D map displays.
11	MAP DIR	AUD, DVD	<b>DNX3</b> <b>DNX7</b> Switches the display angle each time it is pressed.
		NAV	Switches between the heading up navigation and north up navigation map displays.
12	▲/▼	AUD, DVD	Selects the folder to be played. During radio source in AUD mode, select FM/ AM band to be received.
13	◀/▶	AUD, DVD	Selects the track or file to be played. During radio source in AUD mode, switches to broadcast stations received by the unit.
14	Numeric Keypad	AUD	Specifies the number to search in direct search. For details on the direct search mode, see <a href="#">Direct search mode (P.101)</a> .
		DVD	<ul style="list-style-type: none"> <li>• Press [1] [2] to fast forward/backward.</li> <li>• Press [4] [5] to slow forward/backward. Switches the slow playback speed each time you press this key.*</li> </ul> *DVD only
15	* +	DVD	Clears the number.
16	# BS	AUD, DVD	Switches to the direct search mode. For details on the direct search mode, see <a href="#">Direct search mode (P.101)</a> .
17	AUDIO	DVD	Switches the voice language each time you press this key.
18	CANCEL	DVD	Displays previous screen.
		NAV	Cancels the operations.
19	SUBTITLE	DVD	Switches the subtitle language.
20		–	When a call comes in, answers the call.
21	ANGLE	DVD	Switches the picture angle each time you press this key.
22	Vol ▲▼	–	Adjusts the volume.
23	ZOOM	DVD	Switches the zoom ratio (2, 3, 4, Off) each time you press this key.
24	2 ZONE	AUD, DVD	Switches the Dual Zone function on and off.
25	R.VOL 	–	Adjusts volume at rear when the Dual Zone function is on.
26	ATT	–	Lowers the volume by pressing the key once. Restores the previous volume by pressing the key twice.



# Troubleshooting

## Problems and Solutions

If any trouble occurs, first check the following table for possible problems.

- Some functions of this unit may be disabled by some settings made on this unit.
- What might seem to be a malfunction in your unit may just be the result of slight misoperation or miswiring.

### About settings

Problem	Reason	Solution
<ul style="list-style-type: none"> <li>• Cannot set up the subwoofer.</li> <li>• Cannot set up subwoofer phase.</li> <li>• No output from the subwoofer.</li> <li>• Cannot set up the low pass filter.</li> <li>• Cannot set up the high pass filter.</li> </ul>	Subwoofer is not set to on.	Set the subwoofer to on. See <a href="#">Speaker/ X'over setup (P.88)</a> .
<ul style="list-style-type: none"> <li>• Cannot select the output destination of the subsource in the dual zone.</li> <li>• Cannot adjust the volume of the rear speakers.</li> </ul>	The dual zone function is enabled.	Set the dual zone function to off. See <a href="#">Zone Control (P.94)</a> .
<ul style="list-style-type: none"> <li>• Cannot set up the equalizer.</li> <li>• Cannot set up the crossover network.</li> </ul>	The dual zone function is disabled.	Set the dual zone function to on. See <a href="#">Zone Control (P.94)</a> .
	The dual zone function is enabled.	Set the dual zone function to off. See <a href="#">Zone Control (P.94)</a> .

### About audio operations

Problem	Reason	Solution
Radio reception is poor.	The car antenna is not extended.	Pull out the antenna all the way.
	The antenna control wire is not connected.	Connect the wire correctly. See "Connection" in the Quick Start Guide.
Cannot select a folder.	The random play function is enabled.	Turn off the random function.
Cannot perform repeat play during VCD playback.	The PBC function is enabled.	Turn off the PBC function.
The specified disc does not play, but another one plays instead.	The disc is quite dirty.	Clean the disc. See <a href="#">Precautions on handling discs (P.4)</a> .
	The disc is severely scratched.	Try another disc instead.
The sound skips when an audio file is being played.	The disc is scratched or dirty.	Clean the disc. See <a href="#">Precautions on handling discs (P.4)</a> .
	The recording condition is bad.	Record the file again or use another disc.

Other

Problem	Reason	Solution
The Touch Sensor Tone doesn't sound.	The preout jack is being used.	The Touch Sensor Tone cannot be output from the preout jack.

## Error Messages

When you fail to operate the unit correctly, the cause of the failure appears as the message on the screen.

Error Message	Cause	Solution
here is an error in the speaker wiring. Please check the connections.	Protective circuit has been activated because a speaker cord has shorted or it has come in contact with the car chassis.	Wire or insulate the speaker cord as appropriate and turn the power off and on again.
Hot Error	When the internal temperature of this unit rises to 60°C or more, the protection circuit is activated and you may not be able to operate the unit.	Use the unit again after reducing the temperature of the unit.
Mecha Error	The disc player is malfunctioning.	Eject the disc and try inserting it again. Contact the KENWOOD dealer if this indicator continues blinking or the disc cannot be ejected.
Disc Error	An unplayable disc is inserted.	Change the disc. See <a href="#">Playable Media and Files (P.108)</a> .
Read Error	The disc is quite dirty.	Clean the disc. See <a href="#">Precautions on handling discs (P.4)</a> .
	Disc is upside down.	Load the disc with the labeled side up.
Region Code Error	The disc you wanted to play has a region code that cannot be played with this unit.	See <a href="#">Region Codes in the World (P.114)</a> or try another disc.
Error 07–67	The unit is not operating correctly due to some reason or other.	Turn the power off and on again. If the "Error 07–67" message does not disappear, see your nearest KENWOOD dealer.
No Device (USB device)	The USB device is selected as a source although no USB device is connected.	Change the source to any source other than USB/iPod. Connect a USB device, and change the source to USB again.
Disconnected (iPod, Bluetooth audio player)	The iPod/Bluetooth audio player is selected as a source although no iPod/Bluetooth audio player is connected.	Change the source to any source other than iPod/Bluetooth. Connect an iPod/Bluetooth audio player, and change the source to iPod/Bluetooth again.
No Media file	The connected USB device contains no playable audio file. Media was played that doesn't have data recorded that the unit can play.	See <a href="#">Playable Media and Files (P.108)</a> and try another USB device.

## Troubleshooting

Error Message	Cause	Solution
USB device over current status detected.	The connected USB device is rated a current capacity higher than the allowable limit.	Check the USB device. Some trouble may have occurred to the connected USB device.
		Change the source to any source other than USB. Remove the USB device.
Navigation Error. Please turn on power again later.	The communication error has occurred due to severely cold temperature.	Turn on power again after warming your car interior.



# Appendix

## Playable Media and Files

You can play various kinds of media and files on this unit.

### List of playable discs

Disc types	Standard	Support	Remark
DVD	DVD Video	○	
	DVD Audio	×	
	DVD-VR	×	
	DVD-R*1	○	<ul style="list-style-type: none"> <li>• MP3/ WMA/ AAC/ WAV/ FLAC/ Vorbis/ MPEG1/ MPEG2/ MPEG4/ H.264/ WMV/ MKV playback</li> <li>• Multi-border/Multisession playback (Playback depends on authoring conditions)</li> </ul>
	DVD-RW	○	
	DVD+R	○	
	DVD+RW	○	
	DVD-R DL (Dual layer)	○	Only video format
	DVD+R DL (Double layer)	○	
DVD-RAM	×		
CD	Music CD*1	○	
	CD-ROM	○	<ul style="list-style-type: none"> <li>• MP3/ WMA/ AAC/ WAV/ FLAC/ Vorbis playback</li> <li>• Multisession is supported.</li> <li>• Packet write is not supported.</li> </ul>
	CD-R	○	
	CD-RW	○	
	DTS-CD	×	
	Video CD (VCD)	○	
	Super video CD	×	
	Photo CD	×	
	CD-EXTRA	△	Only music CD session can be played.
	HDCD	○	
CCCD	×		
Others	Dualdisc	×	
	Super audio CD	△	Only CD layer can be played.

\*1 Incompatible with 8 cm (3 inch) discs.

○ : Playback is possible.

△ : Playback is partly possible.

×

## ■ Use of DualDisc

When playing a "DualDisc" on this unit, the surface of the disc that is not played may be scratched while the disc is inserted or ejected. Since the music CD surface does not conform to the CD standard, playback may be impossible. (A "DualDisc" is a disc with one surface containing DVD standard signals and the other surface containing music CD signals.)

## ■ About disc format

The disc format should be the one of the following.

- ISO 9660 Level 1/2
- Joliet
- Romeo
- Long file name

## About files

The following audio, video, and picture files are supported.

### ■ Playable Audio files

	Bit rate	Sampling frequency	Bit count
AAC-LC (.m4a)	8 – 320kbps, VBR	16 – 48 kHz	16 bit
MP3 (.mp3)	8 – 320kbps, VBR	16 – 48 kHz	16 bit
WMA (.wma)	8 – 320kbps	16 – 48 kHz	16 bit
Linear PCM (WAVE) (.wav)	–	16 – 48 kHz (Disc), 16 – 192 kHz (USB/ SD)	16/ 24 bit
FLAC (.flac)	–	16 – 48 kHz (Disc), 16 – 192 kHz (USB/ SD)	16/ 24 bit
Vorbis (.ogg)	VBR	16 – 48 kHz	16 bit

### NOTE

- If music of normal CD and other playback systems are recorded in the same disc, only the playback system recorded at the first setout is played.
- WMA and AAC of which is covered with DRM cannot be played.
- Although the audio files are complied with the standards listed above, the play may be impossible depending on the types or conditions of media or device.
- An online manual about audio files is put on the site, [www.kenwood.com/cs/ce/audiophile/](http://www.kenwood.com/cs/ce/audiophile/).  
On this online manual, detailed information and notes which are not written in this manual are provided. Make sure to read through the online manual as well.

### ■ Acceptable Video files

	Profile	Max. Picture size	Max. bit rate	Audio format
MPEG-1 (.mpg, .mpeg)	–	352 × 240, 352 × 288	1.5 Mbps	MPEG Audio Layer 2
MPEG-2 (.mpg, .mpeg)	MP@ML	720 × 480, 720 × 576	8M bps	MPEG Audio Layer 2
H.264/MPEG-4 AVC (.mp4, .m4v, .avi, .flv, .f4v)	Baseline Profile, Main Profile	1280 × 720 (30 fps)	8M bps	MP3, AAC
MPEG-4 (.mp4, .avi)	Advanced Simple Profile	1920 × 1080 (30 fps)	8M bps	MP3, AAC
WMV (.wmv)	Main Profile	1920 × 1080 (30 fps)	8M bps	WMA
MKV (.mkv)	Video Format follows H.264/MPEG-4 AVC, MPEG-4, WMV			MP3, AAC, WMA, Vorbis, FLAC

### ■ Playing order of files

In the example of folder/file tree shown below, the files are played in the order from ① to ⑩.

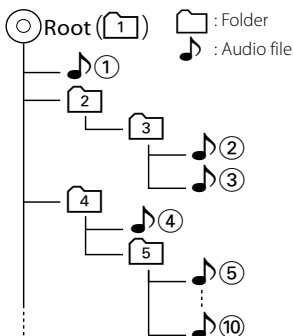

### Connectable iPod/iPhone

The following models can be connected to this unit.

Made for

- iPhone 6s Plus
- iPhone 6s
- iPhone 6 Plus
- iPhone 6
- iPhone 5s
- iPhone 5c
- iPhone 5
- iPhone 4s
- iPod touch (6th generation)
- iPod touch (5th generation)

#### NOTE

- For the details of the necessary cable and adapter to connect with iPod/iPhone, refer to [Music/Video Basic Operation \(P.36\)](#).
- Latest compatible list of iPod/iPhone. For details, see [www.kenwood.com/cs/ce/ipod/](http://www.kenwood.com/cs/ce/ipod/).
- By connecting your iPod/iPhone to this unit with an optional accessory iPod connection cable KCA-iP103 or KCA-iP102, you can supply power to your iPod/iPhone as well as charge it while playing music. However, the power of this unit must be on.
- If you start playback after connecting the iPod, the music that has been played by the iPod is played first.  
In this case, "Reading" is displayed without displaying a folder name, etc. Changing the browse item will display a correct title, etc.
- When the iPod is connected to this unit, "KENWOOD" or "✓" is displayed on the iPod to indicate that you cannot operate the iPod.

## Usable USB device

You can use a mass-storage-class USB device on this unit.

The word “USB device” appearing in this manual indicates a flash memory device and digital audio players can be recognized as mass-storage.

### ■ About file system

The file system should be the one of the following.

- FAT16
- FAT32
- exFAT
- NTFS

#### NOTE

- When the USB device is connected to this unit, it can be charged through the USB cable.
- Install the USB device in the place where it will not affect safe driving.
- You cannot connect a USB device via a USB hub and Multi Card Reader.
- Take backups of the audio files used with this unit. The files can be erased depending on the operating conditions of the USB device. We shall have no compensation for any damage arising from any erased data.
- No USB device comes with this unit. You need to purchase a commercially available USB device.
- When connecting the USB device, usage of the CA-U1EX (option) is recommended. (However, maximum supply current of CA-U1EX is 500mA.) Normal playback is not guaranteed when a cable other than the USB compatible cable is used.

## Usable SD card **DNX8/7** and microSD card **DNX5/3**.

The unit is capable of playback of SD/SDHC memory cards **DNX8/7** or microSD/microSDHC memory cards **DNX5/3** complying with the SD or SDHC standard.

A special adapter is required to use a miniSD card, miniSDHC card, microSD card, or microSDHC card.

The MultiMedia Card (MMC) cannot be used.



## Status Bar Indicator Items

Shown below is a list of indicators displayed on the status bar in the screen.  
Current status of this unit is displayed on the bar.

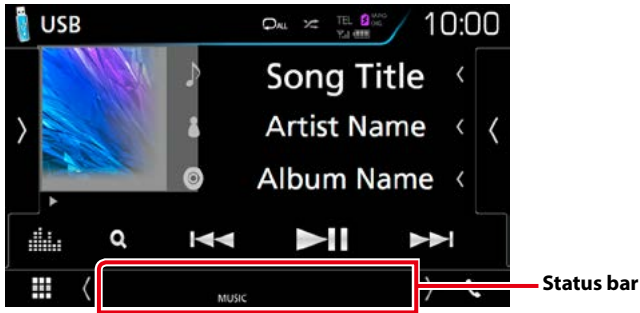

### ■ General

#### **ATT**

The attenuator is active.

#### **DUAL**

The dual zone function is on.

#### **MUTE**

The mute function is active.

#### **LOUD**

The loudness control function is on.

### ■ DVD/CD

#### **IN**

A disc is inserted.

- White: A Disc is inside the unit.
- Orange: Error at the disc player

#### **VIDEO**

Identifies the video file.

#### **MUSIC**

Identifies the music file.

### ■ VCD

#### **1chLL/2chLL**

Identifies the left audio output of channel 1 or 2.

#### **1chLR/2chLR**

Identifies the monaural audio output of channel 1 or 2.

#### **1chRR/2chRR**

Identifies the right audio output of channel 1 or 2.

#### **1chST/2chST**

Identifies the stereo audio output of channel 1 or 2.

#### **LL**

Identifies the left audio output.

#### **LR**

Identifies the monaural audio output.

#### **RR**

Identifies the right audio output.

#### **ST**

Identifies the stereo audio output.

#### **PBC**

The PBC function is on.

#### **VER1**

The VCD version is 1.

#### **VER2**

The VCD version is 2.

## ■ USB/SD

### VIDEO

Identifies the video file.

### MUSIC

Identifies the music file.

## ■ iPod

### MUSIC

Identifies the music file.

## ■ Digital Radio

### DAB

Digital Radio is being received.

### RDS

Radio Data System is being received.

### MC

Receiving service is displayed.

- White: Primary Component is received.
- Orange: Secondary Component is received.

## ■ Tuner

### ST

A stereo broadcast is being received.

### MONO

The forced monaural function is on.

### AF

The AF search function is on.

### EON

The Radio Data System station is sending EON.

### Lo.S

The Local Seek function is on.

### NEWS

News bulletin interruption is in progress.

### RDS

Indicates the state of the Radio Data System station when the AF function is on.

- White: Radio Data System is being received.
- Orange: Radio Data System is not being received.

### TI

Indicates the reception state of traffic information.

- White: TP is being received.
- Orange: TP is not being received.

## Region Codes in the World

The DVD players are given a region code according to the country or area it is marketed, as shown in the following map.

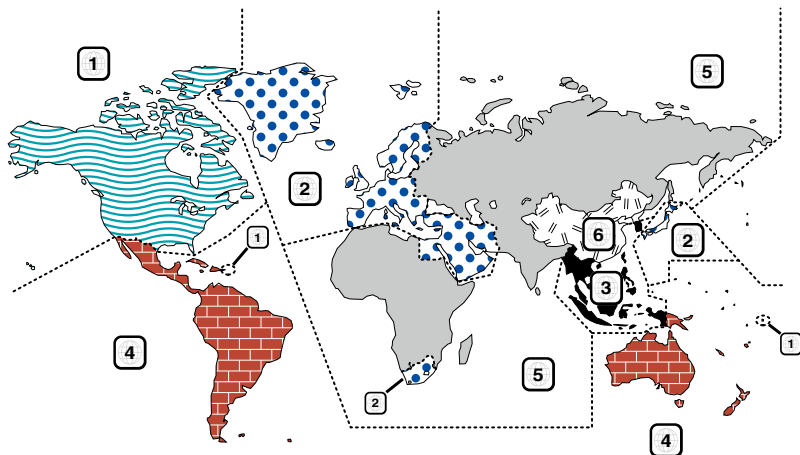

### ■ DVD disc marks



Indicates a region number. The discs with this mark can be played with any DVD player.



Indicates the number of audio languages recorded. Up to 8 languages can be recorded in a movie. You can select a favorite language.



Indicates the number of subtitled languages recorded. Up to 32 languages can be recorded.



If a DVD disc has scenes shot from multiple angles, you can select a favorite angle.

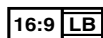

Indicates the type of screen for the image. The left mark indicates that a wide image picture (16:9) is displayed on a standard TV set screen (4:3) with a black band at both the top and bottom of the screen (letter box).

### ■ Operation regulatory marks

With this DVD, some functions of this unit such as the play function may be restricted depending on the location where the DVD is playing. In this case, the following marks will appear on the screen. For more information, refer to the disc manual.



### ■ Discs with limited period of use

Do not leave discs with a limited period of use in this unit. If you load an already expired disc, you may not be able to remove it from this unit.

## DVD Language Codes

Code	Language
aa	Afar
ab	Abkhazian
af	Afrikaans
am	Amharic
ar	Arabic
as	Assamese
ay	Aymara
az	Azerbaijani
ba	Bashkir
be	Byelorussian
bg	Bulgarian
bh	Bihari
bi	Bislama
bn	Bengali, Bangla
bo	Tibetan
br	Breton
ca	Catalan
co	Corsican
cs	Czech
cy	Welsh
da	Danish
de	German
dz	Bhutani
el	Greek
en	English
eo	Esperanto
es	Spanish
et	Estonian
eu	Basque
fa	Persian
fi	Finnish
fj	Fiji
fo	Faroese
fr	French
fy	Frisian
ga	Irish
gd	Scots Gaelic
gl	Galician
gn	Guarani
gu	Gujarati
ha	Hausa
he	Hebrew
hi	Hindi
hr	Croatian
hu	Hungarian
hy	Armenian

Code	Language
ia	Interlingua
ie	Interlingue
ik	Inupiak
id	Indonesian
is	Icelandic
it	Italian
ja	Japanese
jav	Javanese
ka	Georgian
kk	Kazakh
kl	Greenlandic
km	Cambodian
kn	Kannada
ko	Korean
ks	Kashmiri
ku	Kurdish
ky	Kirghiz
la	Latin
lb	Luxembourgish
ln	Lingala
lo	Laotian
lt	Lithuanian
lv	Latvian, Lettish
mg	Malagasy
mi	Maori
mk	Macedonian
ml	Malayalam
mn	Mongolian
mo	Moldavian
mr	Marathi
ms	Malay
mt	Maltese
my	Burmese
na	Nauru
ne	Nepali
nl	Dutch
no	Norwegian
oc	Occitan
om	(Afan) Oromo
or	Oriya
pa	Punjabi
pl	Polish
ps	Pashto, Pushto
pt	Portuguese
qu	Quechua
rm	Rhaeto-Romance

Code	Language
rn	Kirundi
ro	Romanian
ru	Russian
rw	Kinyarwanda
sa	Sanskrit
sd	Sindhi
sg	Sangho
sh	Serbo-Croatian
si	Singhalese
sk	Slovak
sl	Slovenian
sm	Samoaan
sn	Shona
so	Somali
sq	Albanian
sr	Serbian
ss	Siswati
st	Sesotho
su	Sundanese
sv	Swedish
sw	Swahili
ta	Tamil
te	Telugu
tg	Tajik
th	Thai
ti	Tigrinya
tk	Turkmen
tl	Tagalog
tn	Setswana
to	Tongan
tr	Turkish
ts	Tsonga
tt	Tatar
tw	Twí
uk	Ukrainian
ur	Urdu
uz	Uzbek
vi	Vietnamese
vo	Volapuk
wo	Wolof
xh	Xhosa
yo	Yoruba
zh	Chinese
zu	Zulu

## Specifications

### ■ Monitor section

#### Picture Size

DNX8160DABS, DNX716WDABS, DNX516DABS  
: 6.95 inches (diagonal) wide  
: 156.6 mm (W) × 81.6 mm (H)  
6-3/16 × 3-3/16 inch  
DNX5160DABS, DNX5160BTS, DNX3160BT  
: 6.2 inches (diagonal) wide  
: 137.5 mm (W) × 77.2 mm (H)  
5-7/16 × 3-1/16 inch

#### Display System

: Transparent TN LCD panel

#### Drive System

: TFT active matrix system

#### Number of Pixels

: 1,152,000 (800H x 480V x RGB)

#### Effective Pixels

: 99.99 %

#### Pixel Arrangement

: RGB striped arrangement

#### Back Lighting

: LED

### ■ DVD player section

#### D/A Converter

: 24/ 32 bit

#### Audio Decoder

: Linear PCM/ Dolby Digital/ MP3/ WMA/ AAC/ WAV/  
FLAC/ Vorbis

#### Video Decoder

: MPEG1/ MPEG2/ MPEG4/ WMV/ H.264/ mkv

#### Wow & Flutter

: Below Measurable Limit

#### Frequency Response

- 96 kHz : 20 – 44,000 Hz
- 48 kHz : 20 – 22,000 Hz
- 44.1 kHz : 20 – 20,000 Hz

#### Total Harmonic Distortion

: 0.010 % (1 kHz)

#### S/N Ratio (dB)

: 98 dB (DVD-Video 96 kHz)

#### Dynamic Range

: 98 dB (DVD-Video 96 kHz)

#### Disc Format

: DVD-Video/ VIDEO-CD/ CD-DA

#### Quantifying Bit Number

: 16/ 20/ 24 bit

### ■ USB interface section



#### USB Standard

: USB 2.0 High Speed

#### File System

: FAT 16/ 32, NTFS

#### Maximum Power Supply Current

DNX8160DABS, DNX716WDABS, DNX5160DABS,  
DNX5160BTS, DNX516DABS  
: DC 5 V  1.5 A × 2  
DNX3160BT  
: DC 5 V  1.5 A

#### D/A Converter

: 24 Bit

#### Audio Decoder

: MP3/ WMA/ AAC/ WAV/ FLAC/ Vorbis

#### Video Decoder

: MPEG1/ MPEG2/ MPEG4/ WMV/ H.264/ mkv

### ■ SD (DNX8160DABS, DNX716WDABS, DNX5160DABS, DNX5160BTS, DNX516DABS)

#### SD Standard

: SD / SDHC

#### Compatible File System

: FAT 16/ 32, NTFS

#### Capacity

: Maximum 32G Byte

#### Data Transfer Rate

: Maximum 24 Mbps

#### Audio Decoder

: MP3/ WMA/ AAC/ WAV/ FLAC/ Vorbis

#### Video Decoder

: MPEG1/ MPEG2/ MPEG4/ WMV/ H.264/ mkv

### ■ HDMI/ MHL section

#### HDMI

: HDMI Type-A

#### MHL Supported Version

: MHL 2

#### MHL Maximum Power Supply Current

: DC 5 V  900 mA

## ■ Bluetooth section

### Technology

: Bluetooth Ver.3.0

### Frequency

: 2.402 – 2.480 GHz

### Output Power

: +4dBm (MAX), 0dBm (AVE), Power Class2

### Maximum Communication range

: Line of sight approx. 10m (32.8 ft)

### Audio Codec

SBC/ AAC

### Profile (Multi Profile support)

- HFP (V1.6) (Hands Free Profile)
- SPP (Serial Port Profile)
- A2DP (Advanced Audio Distribution Profile)
- AVRCP (V1.5) (Audio/Video Remote Control Profile)
- HID (Human Interface Device Profile)
- PBAP (Phonebook Access Profile)
- GAP (Generic Access Profile)

## ■ DSP section

### Graphics equalizer

Band: 13 Band

Frequency (BAND1 – 13)

: 62.5/ 100/ 160/ 250/ 400/ 630/ 1k/ 1.6k/ 2.5k/ 4k/  
6.3k/ 10k/ 16k Hz

### Gain

: -9/-8/-7/-6/-5/-4/-3/-2/-1/0/1/2/3/4/5/6/7/8/9 dB

### 2Way X'Over

#### High pass filter

Frequency: Through, 30/ 40/ 50/ 60/ 70/ 80/ 90/ 100/  
120/ 150 / 180/ 220/ 250 Hz

Slope: -6/-12/-18/-24 dB/Oct.

#### Low pass filter

Frequency: 30/ 40/ 50/ 60/ 70/ 80/ 90/ 100/ 120/  
150/ 180/ 220/ 250 Hz, Through

Slope: -6/-12/-18/-24 dB/Oct.

### Position

#### Front / Rear /Subwoofer Delay

: 0 – 6.1 m (0.01 m Step)

#### Gain

: -8 – 0 dB

### Subwoofer level

: -50 – +10 dB

## ■ DAB section (DNX8160DABS, DNX716WDABS, DNX5160DABS, DNX516DABS)

### Frequency Range

L-BAND: 1452.960 – 1490.624 (MHz)

BAND III: 174.928 – 239.200 (MHz)

### Sensitivity

: -100 dBm

### S/N Ratio (dB)

: 90 dB

## ■ Digital Antenna Connector section (DNX8160DABS, DNX716WDABS, DNX5160DABS, DNX516DABS)

### Connector type

: SMB

### Output Voltage (11 – 16V)

: 14.4 V

### Maximum Current

: < 100 mA

## ■ FM tuner section

### Frequency Range (step)

: 87.5 MHz – 108.0 MHz (50 kHz)

### Usable Sensitivity (S/N : 26 dB)

: 9.3 dBf (0.8  $\mu$ V/75  $\Omega$ )

### Quieting Sensitivity (S/N : 46 dB)

: 15.2 dBf (1.6  $\mu$ V/75  $\Omega$ )

### Frequency Response

: 30 Hz – 15 kHz

### S/N Ratio (dB)

: 75 dB (MONO)

### Selectivity ( $\pm$ 400 kHz)

: Over 80 dB

### Stereo Separation

: 45 dB (1 kHz)

## ■ AM tuner section

### Frequency Range (step)

LW: 153 – 279 kHz (9 kHz)

MW: 531 – 1611 kHz (9 kHz)

### Usable Sensitivity

MW: 25 $\mu$ V

LW: 45 $\mu$ V

### ■ Video section

#### Color System of External Video Input

: NTSC/PAL

#### External Video Input Level (RCA jacks)

: 1 Vp-p/ 75  $\Omega$

#### External Video Input Level (mini jack)

: 1 Vp-p/ 75  $\Omega$

#### External Audio Max Input Level (RCA jacks)

: 2 V/ 25 k $\Omega$

#### External Audio Max Input Level (mini jack)

: 2 V/ 25 k $\Omega$

#### Video Input Level (RCA jacks)

: 1 Vp-p/ 75  $\Omega$

#### Video Output Level (RCA jacks)

: 1 Vp-p/ 75  $\Omega$

#### Audio Output Level (RCA jacks)

: 1.2 V/ 10 k $\Omega$

### ■ Audio section

#### Maximum Power (Front & Rear)

: 50 W  $\times$  4

#### Typical Power Output (Front & Rear)

Full Bandwidth Power (at less than 1% THD)

: 22 W  $\times$  4

#### Preout Level (V)

DNX8160DABS, DNX716WDABS

: 5 V/ 10 k $\Omega$

DNX5160DABS, DNX516DABS, DNX5160BTS,

DNX3160BT

: 4 V/ 10 k $\Omega$

#### Preout Impedance

DNX8160DABS, DNX716WDABS

:  $\leq$  300  $\Omega$

DNX5160DABS, DNX516DABS, DNX5160BTS,

DNX3160BT

:  $\leq$  600  $\Omega$

#### Speaker Impedance

: 4 – 8  $\Omega$

### ■ Navigation section

#### Receiver

: High-sensitivity GPS receiver

#### Reception Frequency

: 1575.42 MHz (C/A code)

#### Acquisition Times

Cold : 29 seconds (typ)

(All satellites at -130 dBm Without aiding)

#### Update Rate

: 1/second, continuous

#### Accuracy

Position: <2.5 meters, CEP, at -130 dBm

Velocity: 0.1 meter/sec

#### Position Method

: GPS

#### Antenna

: External GPS antenna

## ■ General

### Operating Voltage

: 14.4 V (10.5 – 16 V allowable)

### Maximum Current Consumption

: 15 A

### Installation Dimensions (W × H × D)

DNX8160DABS

: 182 × 112 × 163 mm

DNX716WDABS

: 178 × 100 × 160 mm

DNX5160DABS, DNX5160BTS, DNX3160BT

: 182 × 112 × 153 mm

DNX516DABS

: 178 × 100 × 147 mm

### Including the sub panel part (W × H × D)

DNX716WDABS

: 206 × 104 × 160 mm

### Operational Temperature Range

: -10 °C – +60 °C

### Weight

DNX8160DABS

: 2.7 kg

DNX716WDABS

: 2.5 kg

DNX5160DABS, DNX5160BTS, DNX3160BT

: 2.0 kg

DNX516DABS

: 2.3 kg

### NOTE

- Although the effective pixels for the liquid crystal panel is given as 99.99% or more, 0.01% of pixels may not light or may light incorrectly.

**Specifications subject to change without notice.**

## About this Unit

### ■ Copyrights

- The Bluetooth word mark and logos are owned by the Bluetooth SIG, Inc. and any use of such marks by JVC KENWOOD Corporation is under license. Other trademarks and trade names are those of their respective owners.
- The “AAC” logo is a trademark of Dolby Laboratories.
- “Made for iPod” and “Made for iPhone” mean that an electronic accessory has been designed to connect specifically to iPod, or iPhone, respectively, and has been certified by the developer to meet Apple performance standards. Apple is not responsible for the operation of this device or its compliance with safety and regulatory standards. Please note that the use of this accessory with iPod, or iPhone may affect wireless performance.
- iPhone, iPod, iPod classic, iPod nano, and iPod touch are trademarks of Apple Inc., registered in the U.S. and other countries.
- Apple, Siri, Apple CarPlay and Apple CarPlay logo are trademarks of Apple Inc., registered in the U.S. and other countries.
-  is a trademark of DVD Format/Logo Licensing Corporation registered in the U.S., Japan and other countries.
- This item incorporates copy protection technology that is protected by U.S. patents and other intellectual property rights of Rovi Corporation. Reverse engineering and disassembly are prohibited.
- Manufactured under license from Dolby Laboratories. Dolby and the double-D symbol are trademarks of Dolby Laboratories.
- SPOTIFY and the Spotify logo are among the registered trademarks of Spotify AB.
- INRIX is a registered trademark of INRIX, Inc.
- Android, Android Auto, Google Play and other marks are trademarks of Google Inc.
- BlackBerry®, RIM®, Research In Motion® and related trademarks, names and logos are the property of Research In Motion Limited and are registered and/or used in the U.S. and countries around the world. Used under license from Research In Motion Limited.
- SDHC and microSDHC Logos are trademarks of SD-3C, LLC.
- Adobe, Acrobat and Reader are either registered trademarks or trademarks of Adobe Systems Incorporated in the United States and/or other countries.
- QR Code ® is registered trademarks of DENSO WAVE INCORPORATED in JAPAN and other countries.
- The terms HDMI and HDMI High-Definition Multimedia Interface, and the HDMI logo are trademarks or registered trademarks of HDMI Licensing LLC in the United States and other countries.



## Appendix

- MHL and the MHL logo are a trademark or registered trademark of MHL, LLC.
  - Incorporates MHL 2
- THIS PRODUCT IS LICENSED UNDER THE AVC PATENT PORTFOLIO LICENSE FOR THE PERSONAL USE OF A CONSUMER OR OTHER USES IN WHICH IT DOES NOT RECEIVE REMUNERATION TO (j) ENCODE VIDEO IN COMPLIANCE WITH THE AVC STANDARD ("AVC VIDEO") AND/OR (j) DECODE AVC VIDEO THAT WAS ENCODED BY A CONSUMER ENGAGED IN A PERSONAL ACTIVITY AND/OR WAS OBTAINED FROM A VIDEO PROVIDER LICENSED TO PROVIDE AVC VIDEO. NO LICENSE IS GRANTED OR SHALL BE IMPLIED FOR ANY OTHER USE. ADDITIONAL INFORMATION MAY BE OBTAINED FROM MPEG LA, L.L.C. SEE [HTTP://WWW.MPEGLA.COM](http://www.mpegla.com)
- THIS PRODUCT IS LICENSED UNDER THE MPEG-4 VISUAL PATENT PORTFOLIO LICENSE FOR THE PERSONAL AND NON-COMMERCIAL USE OF A CONSUMER FOR (j) ENCODING VIDEO IN COMPLIANCE WITH THE MPEG-4 VISUAL STANDARD ("MPEG-4 VIDEO") AND/OR (j) DECODING MPEG-4 VIDEO THAT WAS ENCODED BY A CONSUMER ENGAGED IN A PERSONAL AND NON-COMMERCIAL ACTIVITY AND/OR WAS OBTAINED FROM A VIDEO PROVIDER LICENSED BY MPEG LA TO PROVIDE MPEG-4 VIDEO. NO LICENSE IS GRANTED OR SHALL BE IMPLIED FOR ANY OTHER USE. ADDITIONAL INFORMATION INCLUDING THAT RELATING TO PROMOTIONAL, INTERNAL AND COMMERCIAL USES AND LICENSING MAY BE OBTAINED FROM MPEG LA, L.L.C. SEE [HTTP://WWW.MPEGLA.COM](http://www.mpegla.com).
- THIS PRODUCT IS LICENSED UNDER THE VC-1 PATENT PORTFOLIO LICENSE FOR THE PERSONAL AND NON-COMMERCIAL USE OF A CONSUMER TO (i) ENCODE VIDEO IN COMPLIANCE WITH THE VC-1 STANDARD ("VC-1 VIDEO") AND/OR (ii) DECODE VC-1 VIDEO THAT WAS ENCODED BY A CONSUMER ENGAGED IN A PERSONAL AND NON-COMMERCIAL ACTIVITY AND/OR WAS OBTAINED FROM A VIDEO PROVIDER LICENSED TO PROVIDE VC-1 VIDEO. NO LICENSE IS GRANTED OR SHALL BE IMPLIED FOR ANY OTHER USE. ADDITIONAL INFORMATION MAY BE OBTAINED FROM MPEG LA, L.L.C. SEE [HTTP://WWW.MPEGLA.COM](http://www.mpegla.com)
- libFLAC  
Copyright (C) 2000,2001,2002,2003,2004,2005,2006,2007,2008,2009 Josh Coalson  
Redistribution and use in source and binary forms, with or without modification, are permitted provided that the following conditions are met:
  - Redistributions of source code must retain the above copyright notice, this list of conditions and the following disclaimer.
  - Redistributions in binary form must reproduce the above copyright notice, this list of conditions and the following disclaimer in the documentation and/or other materials provided with the distribution.
  - Neither the name of the Xiph.org Foundation nor the names of its contributors may be used to endorse or promote products derived from this software without

specific prior written permission.

THIS SOFTWARE IS PROVIDED BY THE COPYRIGHT HOLDERS AND CONTRIBUTORS "AS IS" AND ANY EXPRESS OR IMPLIED WARRANTIES, INCLUDING, BUT NOT LIMITED TO, THE IMPLIED WARRANTIES OF MERCHANTABILITY AND FITNESS FOR A PARTICULAR PURPOSE ARE DISCLAIMED. IN NO EVENT SHALL THE FOUNDATION OR CONTRIBUTORS BE LIABLE FOR ANY DIRECT, INDIRECT, INCIDENTAL, SPECIAL, EXEMPLARY, OR CONSEQUENTIAL DAMAGES (INCLUDING, BUT NOT LIMITED TO, PROCUREMENT OF SUBSTITUTE GOODS OR SERVICES; LOSS OF USE, DATA, OR PROFITS; OR BUSINESS INTERRUPTION) HOWEVER CAUSED AND ON ANY THEORY OF LIABILITY, WHETHER IN CONTRACT, STRICT LIABILITY, OR TORT (INCLUDING NEGLIGENCE OR OTHERWISE) ARISING IN ANY WAY OUT OF THE USE OF THIS SOFTWARE, EVEN IF ADVISED OF THE POSSIBILITY OF SUCH DAMAGE.

- libvorbis  
Copyright (c) 2002-2008 Xiph.org Foundation  
Redistribution and use in source and binary forms, with or without modification, are permitted provided that the following conditions are met:
  - Redistributions of source code must retain the above copyright notice, this list of conditions and the following disclaimer.
  - Redistributions in binary form must reproduce the above copyright notice, this list of conditions and the following disclaimer in the documentation and/or other materials provided with the distribution.
  - Neither the name of the Xiph.org Foundation nor the names of its contributors may be used to endorse or promote products derived from this software without specific prior written permission.THIS SOFTWARE IS PROVIDED BY THE COPYRIGHT HOLDERS AND CONTRIBUTORS "AS IS" AND ANY EXPRESS OR IMPLIED WARRANTIES, INCLUDING, BUT NOT LIMITED TO, THE IMPLIED WARRANTIES OF MERCHANTABILITY AND FITNESS FOR A PARTICULAR PURPOSE ARE DISCLAIMED. IN NO EVENT SHALL THE FOUNDATION OR CONTRIBUTORS BE LIABLE FOR ANY DIRECT, INDIRECT, INCIDENTAL, SPECIAL, EXEMPLARY, OR CONSEQUENTIAL DAMAGES (INCLUDING, BUT NOT LIMITED TO, PROCUREMENT OF SUBSTITUTE GOODS OR SERVICES; LOSS OF USE, DATA, OR PROFITS; OR BUSINESS INTERRUPTION) HOWEVER CAUSED AND ON ANY THEORY OF LIABILITY, WHETHER IN CONTRACT, STRICT LIABILITY, OR TORT (INCLUDING NEGLIGENCE OR OTHERWISE) ARISING IN ANY WAY OUT OF THE USE OF THIS SOFTWARE, EVEN IF ADVISED OF THE POSSIBILITY OF SUCH DAMAGE.
- libogg  
Copyright (c) 2002, Xiph.org Foundation  
Redistribution and use in source and binary forms, with or without modification, are permitted provided that the following conditions are met:
  - Redistributions of source code must retain the above copyright notice, this list of conditions and the following disclaimer.
  - Redistributions in binary form must reproduce the

above copyright notice, this list of conditions and the following disclaimer in the documentation and/or other materials provided with the distribution.

- Neither the name of the Xiph.org Foundation nor the names of its contributors may be used to endorse or promote products derived from this software without specific prior written permission.

THIS SOFTWARE IS PROVIDED BY THE COPYRIGHT HOLDERS AND CONTRIBUTORS "AS IS" AND ANY EXPRESS OR IMPLIED WARRANTIES, INCLUDING, BUT NOT LIMITED TO, THE IMPLIED WARRANTIES OF MERCHANTABILITY AND FITNESS FOR A PARTICULAR PURPOSE ARE DISCLAIMED. IN NO EVENT SHALL THE FOUNDATION OR CONTRIBUTORS BE LIABLE FOR ANY DIRECT, INDIRECT, INCIDENTAL, SPECIAL, EXEMPLARY, OR CONSEQUENTIAL DAMAGES (INCLUDING, BUT NOT LIMITED TO, PROCUREMENT OF SUBSTITUTE GOODS OR SERVICES; LOSS OF USE, DATA, OR PROFITS; OR BUSINESS INTERRUPTION) HOWEVER CAUSED AND ON ANY THEORY OF LIABILITY, WHETHER IN CONTRACT, STRICT LIABILITY, OR TORT (INCLUDING NEGLIGENCE OR OTHERWISE) ARISING IN ANY WAY OUT OF THE USE OF THIS SOFTWARE, EVEN IF ADVISED OF THE POSSIBILITY OF SUCH DAMAGE.

## ■ The marking of products using lasers



**CLASS 1  
LASER PRODUCT**

The label is attached to the chassis/case and says that the component uses laser beams that have been classified as Class 1. It means that the unit is utilizing laser beams that are of a weaker class. There is no danger of hazardous radiation outside the unit.

■ Information on Disposal of Old Electrical and Electronic Equipment and Batteries (applicable for EU countries that have adopted separate waste collection systems)

Products and batteries with the symbol (crossed-out wheeled bin) cannot be disposed as household waste. Old electrical and electronic equipment and batteries should be recycled at a facility capable of handling these items and their waste byproducts.

Contact your local authority for details in locating a recycle facility nearest to you.

Proper recycling and waste disposal will help conserve resources whilst preventing detrimental effects on our health and the environment.

Notice: The sign "Pb" below the symbol for batteries indicates that this battery contains lead.

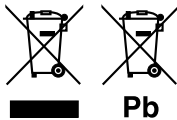

■ מידע בדבר השלכה לאשפה של ציוד חשמלי ואלקטרוני ישן וכן סוללות (רלוונטי למדינות שמשמשות במערכת איסוף אשפה מופרדת).

לא ניתן להשליך מוצרים וסוללות עם הסימון (פח אשפה עם X עליו) כאשפה ביתית רגילה.

יש למחזר ציוד חשמלי ואלקטרוני ישן וכן סוללות במתקן המסוגל לטפל בפריטים כאלה ובתוצרי הלואי שלהם.

צרו קשר עם הרשות המקומית לקבלת פרטים אודות מתקן המיחזור הקרוב אליכם. מיחזור והשלכה לאשפה נאותים יעזרו לשמר משאבים ולמנוע השפעות שליליות על בריאותנו ועל הסביבה.

שימו לב: הסימון Pb שמתחת לסימון עבור סוללות מצוין שהסוללה מכילה עופרת.

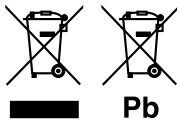



**Declaration of Conformity with regard to the EMC Directive**  
**Declaration of Conformity with regard to the R&TTE Directive 1999/5/EC**  
**Declaration of Conformity with regard to the RoHS Directive 2011/65/EU**

**Manufacturer:**

JVC KENWOOD Corporation

3-12, Moriyacho, Kanagawa-ku, Yokohama-shi, Kanagawa 221-0022, JAPAN

**EU Representative:**

JVCKENWOOD NEDERLAND B.V.

Amsterdamseweg 37, 1422 AC UITHOORN, The Netherlands

**English**

Hereby, JVC KENWOOD declares that this unit DNX8160DABS, DNX716WDABS, DNX5160DABS, DNX516DABS, DNX5160BTS, DNX3160BT is in compliance with the essential requirements and other relevant provisions of Directive 1999/5/EC.

**Français**

Par la présente JVC KENWOOD déclare que l'appareil DNX8160DABS, DNX716WDABS, DNX5160DABS, DNX516DABS, DNX5160BTS, DNX3160BT est conforme aux exigences essentielles et aux autres dispositions pertinentes de la directive 1999/5/CE.

Par la présente, JVC KENWOOD déclare que ce DNX8160DABS, DNX716WDABS, DNX5160DABS, DNX516DABS, DNX5160BTS, DNX3160BT est conforme aux exigences essentielles et aux autres dispositions de la directive 1999/5/CE qui lui sont applicables.

**Deutsch**

Hiermit erklärt JVC KENWOOD, dass sich dieser DNX8160DABS, DNX716WDABS, DNX5160DABS, DNX516DABS, DNX5160BTS, DNX3160BT in Übereinstimmung mit den grundlegenden Anforderungen und den anderen relevanten Vorschriften der Richtlinie 1999/5/EG befindet. (BMW)

Hiermit erklärt JVC KENWOOD die Übereinstimmung des Gerätes DNX8160DABS, DNX716WDABS, DNX5160DABS, DNX516DABS, DNX5160BTS, DNX3160BT mit den grundlegenden Anforderungen und den anderen relevanten Festlegungen der Richtlinie 1999/5/EG. (Wien)

**Nederlands**

Hierbij verklaart JVC KENWOOD dat het toestel DNX8160DABS, DNX716WDABS, DNX5160DABS, DNX516DABS, DNX5160BTS, DNX3160BT in overeenstemming is met de essentiële eisen en de andere relevante bepalingen van richtlijn 1999/5/EG.

Bij deze verklaart JVC KENWOOD dat deze DNX8160DABS, DNX716WDABS, DNX5160DABS, DNX516DABS, DNX5160BTS, DNX3160BT voldoet aan de essentiële eisen en aan de overige relevante bepalingen van Richtlijn 1999/5/EC.

**Italiano**

Con la presente JVC KENWOOD dichiara che questo DNX8160DABS, DNX716WDABS, DNX5160DABS, DNX516DABS, DNX5160BTS, DNX3160BT è conforme ai requisiti essenziali ed alle altre disposizioni pertinenti stabilite dalla direttiva 1999/5/CE.

**Español**

Por medio de la presente JVC KENWOOD declara que el DNX8160DABS, DNX716WDABS, DNX5160DABS, DNX516DABS, DNX5160BTS, DNX3160BT cumple con los requisitos esenciales y cualesquiera otras disposiciones aplicables o exigibles de la Directiva 1999/5/CE.

**Português**

JVC KENWOOD declara que este DNX8160DABS, DNX716WDABS, DNX5160DABS, DNX516DABS, DNX5160BTS, DNX3160BT está conforme com os requisitos essenciais e outras disposições da Directiva 1999/5/CE.

**Polska**

JVC KENWOOD niniejszym oświadcza, że DNX8160DABS, DNX716WDABS, DNX5160DABS, DNX516DABS, DNX5160BTS, DNX3160BT spełnia zasadnicze wymagania oraz inne istotne postanowienia dyrektywy 1999/5/EC.

**Český**

JVC KENWOOD tímto prohlašuje, že DNX8160DABS, DNX716WDABS, DNX5160DABS, DNX516DABS, DNX5160BTS, DNX3160BT je ve shodě se základními požadavky a s dalšími příslušnými ustanoveními Nařízení vlády č. 426/2000 Sb.

**Magyar**

Alulírott, JVC KENWOOD, kijelenti, hogy a jelen DNX8160DABS, DNX716WDABS, DNX5160DABS, DNX516DABS, DNX5160BTS, DNX3160BT megfelel az 1999/5/EC irányelvben meghatározott alapvető követelményeknek és egyéb vonatkozó előírásoknak.

**Croatia**

Ovim putem tvrtka JVC KENWOOD izjavljuje da je ovaj uređaj DNX8160DABS,

DNX716WDABS, DNX5160DABS, DNX516DABS, DNX5160BTS, DNX3160BT ünitesinin, 1999/5/EC Direktifinin başlıca gereksinimleri ve diğer ilgili hükümleri ile uyumlu olduğunu beyan eder.

**Svenska**

Härmed intygar JVC KENWOOD att denna DNX8160DABS, DNX716WDABS, DNX5160DABS, DNX516DABS, DNX5160BTS, DNX3160BT är i överensstämmelse med de väsentliga egenskapskrav och övriga relevanta bestämmelser som framgår av direktiv 1999/5/EG.

**Suomi**

JVC KENWOOD vakuuttaa täten että DNX8160DABS, DNX716WDABS, DNX5160DABS, DNX516DABS, DNX5160BTS, DNX3160BT täyttävien laite on direktiivin 1999/5/EY oleellisten vaatimusten ja sitä koskevien direktiivin muiden ehtojen mukainen.

**Slovensko**

S tem JVC KENWOOD izjavlja, da je ta DNX8160DABS, DNX716WDABS, DNX5160DABS, DNX516DABS, DNX5160BTS, DNX3160BT v skladu z osnovnimi zahtevami in ostalimi ustreznimi predpisi Direktive 1999/5/EC.

**Slovensky**

Spoločnosť JVC KENWOOD týmto vyhlasuje, že DNX8160DABS, DNX716WDABS, DNX5160DABS, DNX516DABS, DNX5160BTS, DNX3160BT spĺňa základné požiadavky a ďalšie príslušné ustanovenia Direktívy 1999/5/EC.

**Dansk**

Undertegnede JVC KENWOOD erklærer herved, at følgende udstyr DNX8160DABS, DNX716WDABS, DNX5160DABS, DNX516DABS, DNX5160BTS, DNX3160BT overholder de væsentlige krav og øvrige relevante krav i direktiv 1999/5/EF.

**Norsk**

JVC KENWOOD erklærer herved at enheten DNX8160DABS, DNX716WDABS, DNX5160DABS, DNX516DABS, DNX5160BTS, DNX3160BT oppfyller grunnleggende krav og andre bestemmelser i direktiv 1999/5/EF.

**Ελληνικά**

ΜΕ ΤΗΝ ΠΑΡΟΥΣΑ JVC KENWOOD ΔΗΛΩΝΕΙ ΟΤΙ ΔNX8160DABS, DNX716WDABS, DNX5160DABS, DNX516DABS, DNX5160BTS, DNX3160BT ΣΥΜΜΟΡΦΩΝΕΤΑΙ ΠΡΟΣ ΤΙΣ ΟΥΣΙΩΔΕΙΣ ΑΠΑΙΤΗΣΕΙΣ ΚΑΙ ΤΙΣ ΛΟΙΠΕΣ ΣΧΕΤΙΚΕΣ ΔΙΑΤΑΞΕΙΣ ΤΗΣ ΟΔΗΓΙΑΣ 1999/5/ΕΚ.

**Eesti**

Sellega kinnitab JVC KENWOOD, et see DNX8160DABS, DNX716WDABS, DNX5160DABS, DNX516DABS, DNX5160BTS, DNX3160BT vastab direktiivi 1999/5/EC põhilistele nõudmistele ja muudele asjakohastele määrustele.

**Latviešu**

Ar šo, JVC KENWOOD, apstiprina, ka DNX8160DABS, DNX716WDABS, DNX5160DABS, DNX516DABS, DNX5160BTS, DNX3160BT atbilst Direktīvas 1999/5/EK galvenajām prasībām un citiem tās nosacījumiem.

**Lietuviškai**

Šiuo, JVC KENWOOD, pareiškia, kad šis DNX8160DABS, DNX716WDABS, DNX5160DABS, DNX516DABS, DNX5160BTS, DNX3160BT atitinka pagrindinius Direktyvos 1999/5/EB reikalavimus ir kitas svarbias nuostatas.

**Malti**

Hawnhekk, JVC KENWOOD, jiddikjara li dan DNX8160DABS, DNX716WDABS, DNX5160DABS, DNX516DABS, DNX5160BTS, DNX3160BT jikkonforma mal-htigijiet essenzjali u ma provvedimenti oħrajn relevanti li hemmi fid-Direttiva 1999/5/EC.

**Українська**

Компанія JVC KENWOOD заявляє, що цей виріб DNX8160DABS, DNX716WDABS, DNX5160DABS, DNX516DABS, DNX5160BTS, DNX3160BT відповідає ключовим вимогам та іншим пов'язаним положенням Директиви 1999/5/EC.

**Türkçe**

Bu vesileyle JVC KENWOOD, DNX8160DABS, DNX716WDABS, DNX5160DABS, DNX516DABS, DNX5160BTS, DNX3160BT ünitesinin, 1999/5/EC Direktifinin başlıca gereksinimleri ve diğer ilgili hükümleri ile uyumlu olduğunu beyan eder.

**HDMI**™  
HIGH-DEFINITION MULTIMEDIA INTERFACE

**MHL**™

**DAB+**  
Digital Audio Broadcasting

 **Bluetooth**®

**SD**™  
**HC**

**micro**™  
**SD**  
**HC**

**DVD**  
VIDEO™

 **DOLBY**  
DIGITAL

 Designed for  
**Windows**  
Media™



 **Spotify**®

Made for

 **iPod**  **iPhone**



Works with  
**Apple CarPlay**

**android**  
**auto**

---

**KENWOOD**