

KENWOOD

DNX8160DABS
DNX716WDABS
DNX5160DABS
DNX516DABS
DNX5160BTS
DNX3160BT

GPS NAVIGATION SYSTEM

Quick Start Guide

JVCKENWOOD Corporation

- Updated information (the latest Instruction Manual, system updates, new functions, etc.) is available from <http://www.kenwood.com/cs/ce/>.

Contents

Before use	2
About the Quick start guide	2
How to read this manual	2
Precautions	2
Safety Precautions and Important Information	4
Initial settings	5
Initial setup	5
Basics	6
Functions of the Buttons on the Front Panel	6
Detaching The Front Panel	7
How to insert an SD Card/ microSD Card	8
Operating with the HOME Screen	9
Common Operations	10
Navigation	11
How to Use the Navigation System	11
DVD/ VCD	12
Playing a disc	12
Playback operations	13
Video menu operations	13
Discs/ USB/ iPod/ SD/ APP	14
Preparation	14
How to Play Music	15
Playback operations	15
Apple CarPlay	16
Android Auto™	17
Mirroring Operation	17
Radio/ Digital Radio	18
Digital Radio Basic Operation	18
Radio Basic Operation	19
Bluetooth smartphone	20
Register your smartphone to the unit	20
Receive a phone call	20
Make a phone call	21
Controlling Audio	22
Controlling General Audio	22
Equalizer Control	22
Installation	23
Before Installation	23
Installing the unit	24
About this Unit	29

Before use

About the Quick start guide

This Quick Start Guide describes basic functions of this unit. For functions not described in this Guide, refer to the Instruction Manual on the following website:
<http://manual.kenwood.com/edition/im391/>



To refer to Instruction manual, a PC loaded with Microsoft® Windows XP/Vista/7/8/10 or Mac OS X® 10.4 or later is required in addition to Adobe® Reader™ 7.1 or Adobe® Acrobat® 7.1 or later.

The Instruction manual is subject to change for modification of specifications and so forth. Be sure to download the latest edition of the Instruction manual for reference.

How to read this manual

- The panels shown in this guide are examples used to provide clear explanations of the operations. For this reason, they may be different from the actual panels.
- In this manual, each model name is abbreviated as follows.
 - DNX8160DABS: **DNX8**
 - DNX716WDABS: **DNX7**
 - DNX5160DABS, DNX516DABS, DNX5160BTS: **DNX5**
 - DNX3160BT: **DNX3**If above icons are showed, read the article applicable to the unit you use.
- In operation procedures, bracket shape indicates the key or button you should control.
 - < >: indicates the name of panel buttons.
 - []: indicates the name of touch keys

Precautions

▲WARNING

■ To prevent injury or fire, take the following precautions:

- To prevent a short circuit, never put or leave any metallic objects (such as coins or metal tools) inside the unit.
- Do not watch or fix your eyes on the unit's display when you are driving for any extended period.
- If you experience problems during installation, consult your KENWOOD dealer.

■ Precautions on using this unit

- When you purchase optional accessories, check with your KENWOOD dealer to make sure that they work with your model and in your area.
- You can select language to display menus, audio file tags, etc. See **User Interface Setup (P.74)** in the Instruction Manual.
- The Radio Data System or Radio Broadcast Data System feature won't work where the service is not supported by any broadcasting station.
- The unit may not function properly if the connectors between the unit and front panel are dirty. Detach the front panel and clean the connector with a cotton swab gently, being careful not to damage the connector.

■ Precautions on battery

- Put the remote control in a place where it will not move during braking or other operations. A dangerous situation could result, if the remote control falls down and gets wedged under the pedals while driving.
- Do not leave the battery near fire or under direct sunlight. A fire, explosion or excessive heat generation may result.
- Do not recharge, short, break up or heat the battery or place it in an open fire. Such actions may cause the battery to leak fluid. If spilled fluid comes in contact with your eyes or on clothing, immediately rinse with water

Before use

and consult a physician.

- Place the battery out of reach of children. In the unlikely event that a child swallows the battery, immediately consult a physician.

Protecting the monitor

- To protect the monitor from damage, do not operate the monitor using a ballpoint pen or similar tool with the sharp tip.

Lens fogging

When you turn on the car heater in cold weather, dew or condensation may form on the lens in the disc player of the unit. Called lens fogging, this condensation on the lens may not allow discs to play. In such a situation, remove the disc and wait for the condensation to evaporate. If the unit still does not operate normally after a while, consult your KENWOOD dealer.

Precautions on handling discs

- Do not touch the recording surface of the disc.
- Do not stick tape etc. on the disc, or use a disc with tape stuck on it.
- Do not use disc type accessories.
- Clean from the center of the disc and move outward.
- When removing discs from this unit, pull them out horizontally.
- If the disc center hole or outside rim has burrs, use the disc only after removing the burrs with a ballpoint pen etc.
- Discs that are not round cannot be used.

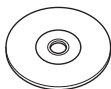

- 8-cm (3 inch) discs cannot be used.
- Discs with coloring on the recording surface or discs that are dirty cannot be used.

- This unit can only play the CDs with



This unit may not correctly play discs which do not have the mark.

- You cannot play a disc that has not been finalized. (For the finalization process see your writing software, and your recorder instruction manual.)

Acquiring GPS signal

The first time you turn on this unit, you must wait while the system acquires satellite signals for the first time.

This process could take up to several minutes. Make sure your vehicle is outdoors in an open area away from tall buildings and trees for fastest acquisition.

After the system acquires satellites for the first time, it will acquire satellites quickly each time thereafter.

About the front panel DNX3 DNX7

When removing the product from the box or installing it, the front panel may be positioned at the angle shown in (Fig. 1). This is due to the characteristics of mechanism the product is equipped with.

When the product is first powered on works properly, the front panel will automatically move into the position (initial setting angle) shown in (Fig. 2).



(Fig. 1)



(Fig. 2)

Cleaning the Unit

If the front panel of this unit is stained, wipe it with a dry soft cloth such as a silicon cloth. If the front panel is stained badly, wipe the stain off with a cloth moistened with neutral cleaner, then wipe it again with a clean soft dry cloth.

CAUTION

- Applying spray cleaner directly to the unit may affect its mechanical parts. Wiping the front panel with a hard cloth or using a volatile liquid such as thinner or alcohol may scratch the surface or erase screened print.

Before use

Safety Precautions and Important Information

Read this information carefully before starting to operate the KENWOOD Car Navigation System and follow the instructions in this manual. Neither KENWOOD nor Garmin shall be liable for problems or accidents resulting from failure to observe the instructions in this manual.

⚠WARNING

Failure to avoid the following potentially hazardous situations could result in an accident or collision resulting in death or serious injury.

When navigating, carefully compare information displayed on the navigation system to all available navigation sources, including information from street signs, visual sightings, and maps. For safety, always resolve any discrepancies or questions before continuing navigation.

Always operate the vehicle in a safe manner.

Do not become distracted by the navigation system while driving, and always be fully aware of all driving conditions. Minimize the amount of time spent viewing the screen of the navigation system while driving, and use voice prompts when possible.

Do not enter destinations, change settings, or access any functions requiring prolonged use of the navigation system controls while driving. Stop your vehicle in a safe and legal manner before attempting such operations.

Keep the system volume at a low enough level to be able to hear outside noises while driving. If you can no longer hear outside noises, you may be unable to react adequately to the traffic situation. This may cause accidents.

The navigation system will not display the correct current position of the vehicle the first time it is used after purchase, or if the vehicle battery is disconnected. GPS satellite signals will soon be received, however, and the correct position will be displayed.

Be careful of the ambient temperature. Using the navigation system at extreme temperatures can lead to malfunction or

damage. Also note that the unit can be damaged by strong vibration, by metal objects, or by water getting inside the unit.

⚠CAUTION

Failure to avoid the following potentially hazardous situations may result in injury or property damage.

The navigation system is designed to provide you with route suggestions. It does not reflect road closures or road conditions, weather conditions, or other factors that may affect safety or timing while driving.

Use the navigation system only as a navigational aid. Do not attempt to use the navigation system for any purpose requiring precise measurement of direction, distance, location, or topography.

The Global Positioning System (GPS) is operated by the United States government, which is solely responsible for its accuracy and maintenance. The government system is subject to changes that could affect the accuracy and performance of all GPS equipment, including the navigation system. Although the navigation system is a precision navigation device, any navigation device can be misused or misinterpreted and, therefore, become unsafe.

IMPORTANT INFORMATION

🔋 Vehicle Battery Preservation

This navigation system can be used when the ignition key is turned to ON or ACC. To preserve the battery, however, it should be used with the engine running whenever possible. Using the navigation system for a long time with the engine switched off can cause the battery to run down.

🗺 Map Data Information

One of the goals of Garmin is to provide customers with the most complete and accurate cartography that is available to us at a reasonable cost. We use a combination of governmental and private data sources, which we identify in product literature and copyright messages displayed to the consumer. Virtually all data sources contain some inaccurate or incomplete data. In some countries, complete and accurate map information is either not available or is prohibitively expensive.

Initial settings

Various setup screens appear automatically before using.

Initial setup

When you first turn on the unit, the screen of the configuration setting will appear.

1 Turn the ignition key of your car to ACC.

The unit is turned on.

Initial SETUP screen appears.

2 Touch the corresponding key and set the value.



Locale

Select the country for the navigation system.

The language, the distance unit, and the gasoline unit are set.

- 1) Touch [Locale].
- 2) Select the desired country.

Language

Select the language used for the control screen and setting items. Default is "British English(en)". (Instruction Manual P.74)

- 1) Touch [Language].
- 2) Touch [Language Select].
- 3) Select the desired language.
- 4) Touch [↩].

Colour

Set the screen and button illumination color. You can select whether to perform color scan and adjust scanning color. (Instruction Manual P.79)

- 1) Touch [Colour].
- 2) Touch [Panel Colour].
- 3) Select the desired color.
- 4) Touch [↩] twice.

Camera

Set the parameters for the camera. (Instruction Manual P.81)

- 1) Touch [Camera].
- 2) Set each item and touch [↩].

DEMO

Set the demonstration mode. Default is "ON".

- 1) Touch [DEMO] and set ON or OFF.

3 Touch [Finish].

Basics

Functions of the Buttons on the Front Panel

DNX8160DABS

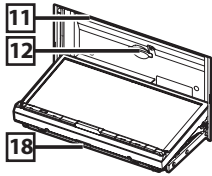
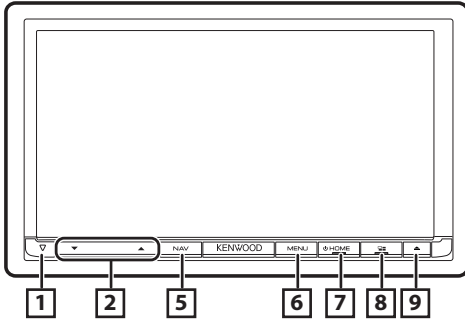

DNX716WDABS

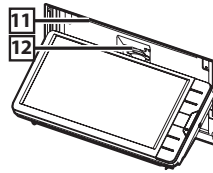
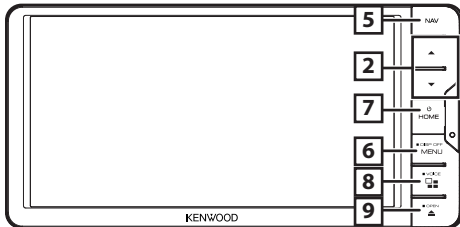

DNX5160DABS/ DNX5160BTS/ DNX3160BT

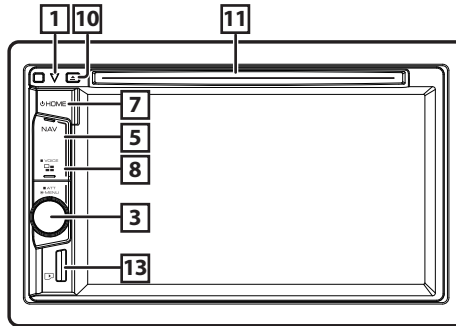

DNX516DABS

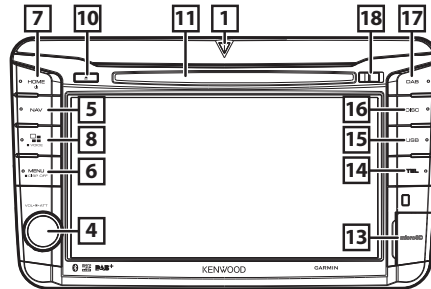

- 1 ▾
 - This indicator flashes when the vehicle ignition is off (Instruction Manual P.78).
- 2 ▲, ▾ (Volume)
 - Adjusts volume. The volume will go up until 15 when you keep pressing [▲].
- 3 Volume knob
 - Turn to adjust the volume.
 - Press to display the pop-up menu.
 - Pressing for 1 second switches attenuation of the volume on/off.
- 4 Volume knob
 - Turning adjusts volume up or down.
 - Pressing switches attenuation of the volume on/off.
- 5 NAV
 - Displays the navigation screen.
- 6 MENU
 - Displays the popup menu screen.
 - Pressing for 1 second turns the screen off.
- 7 HOME
 - Displays the HOME screen (Instruction Manual P.22).
 - Pressing for 1 second turns the power off.
 - When the power off, turns the power on.
- 8
 - Switch the APP (CarPlay/ Android Auto*/ Mirroring*) source.
 - Pressing for 1 second displays the Voice Recognition screen. (Instruction Manual P.69)
- 9 ▲
 - Displays the Angle Adjust screen.
 - [DISC EJECT]: Ejects the disc.
 - [OPEN]: Fully opens the panel to the location of the SD card slot.
 - When the panel is opened, pressing closes the panel.
 - To forcibly eject the disc, press it for 2 seconds and touch [DISC EJECT] after the message is displayed.

Basics

- 10 ▲**
- Ejects the disc.
 - To forcibly eject the disc, press it for 2 seconds and touch [Yes] after the message is displayed.
- 11 Disc insert slot**
- A slot to insert a disc media.
- 12 SD card slot**
- A slot to insert an SD card.
 - See **How to insert an SD Card/ microSD Card (P.8)**.
 - You can play audio/visual file in the card. *3
 - An SD card slot for upgrading the map. For how to upgrade the map, refer to the instruction manual of the navigation system.
- 13 microSD card slot**
- A slot to insert a microSD card.
 - See **How to insert an SD Card/ microSD Card (P.8)**.
 - You can play audio/visual file in the card. *3 (Only for DNX5160DABS, DNX5160BTS, DNX516DABS)
 - A microSD card slot for upgrading the map. For how to upgrade the map, refer to the instruction manual of the navigation system.
- 14 TEL**
- Displays the Hands Free screen.
- 15 USB**
- Switches to the USB sources.
- 16 DISC**
- Switches to the disc media sources.
- 17 DAB**
- Switches to the DAB sources.
- 18 Release key**
- Detaches the part of front panel.

*1 DNX8160DABS/ DNX716WDABS/ DNX516DABS only

*2 DNX8160DABS/ DNX716WDABS only

*3 If the map update file remains in the SD card, you cannot play audio/visual file.

Detaching The Front Panel

You can detach the front panel to prevent theft.

DNX8160DABS

- 1** Press <▲> button.
- 2** Touch [OPEN] to the panel fully opens.
- 3** Detach the panel as the diagrams below.

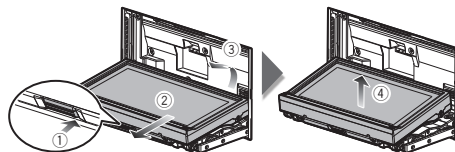

NOTE

- The attaching plate closes automatically in about 10 seconds after the front panel is released. Remove the panel before this happens.

Attaching the front panel

- 1** Hold the panel securely so as not to drop it accidentally, and fit it onto the attaching plate until it is firmly locked.

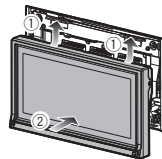

DNX516DABS

- 1** Slide the Release key rightward to detach the part of the front panel.

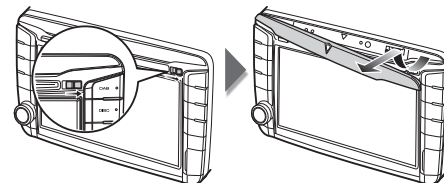

Attaching the front panel

- 1** Hold the panel securely so as not to drop it accidentally, and fit it onto the attaching plate until it is firmly locked.

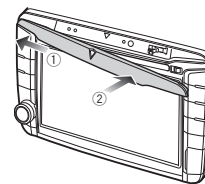

Basics

How to insert an SD Card/ microSD Card

DNX8160DABS/ DNX716WDABS

- 1 Press <▲> button.
- 2 Touch [OPEN] to the panel fully opens.
- 3 Hold the SD card with the label facing up, and insert it into the slot until it clicks.

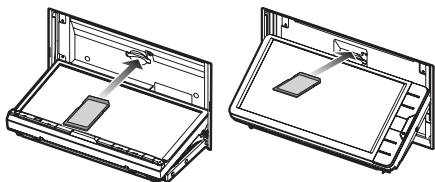

The unit reads the card and playback starts.

- 4 Press <▲> button.

■ Eject an SD Card

- 1 Press <▲> button.
- 2 Touch [OPEN] to the panel fully opens.
- 3 Push the SD card until it clicks and then remove your finger from the card. The card pops up so that you can pull it out with your fingers.
- 4 Press <▲> button.

DNX5160DABS/ DNX5160BTS/ DNX3160BT

- 1 Hold the microSD card with the label side facing right and the notched section down, and insert it into the slot until it clicks.

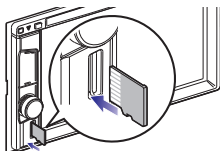

🔗 NOTE

- A dummy microSD card is inserted as the slot cover. Remove it before using and keep it in an appropriate place.

■ Eject a microSD Card

- 1 Push the microSD card until it clicks and then remove your finger from the card. The card pops up so that you can pull it out with your fingers.

DNX516DABS

- 1 Open the microSD card slot cover.
- 2 Hold the microSD card with the label side facing right and the notched section down, and insert it into the slot until it clicks.

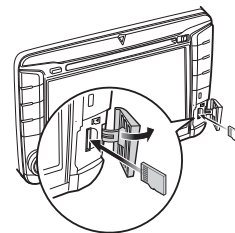

🔗 NOTE

- A dummy microSD card is inserted as the slot cover. Remove it before using and keep it in an appropriate place.

■ Eject a microSD Card

- 1 Open the microSD card slot cover.
- 2 Push the microSD card until it clicks and then remove your finger from the card. The card pops up so that you can pull it out with your fingers.

Basics

Operating with the HOME Screen

Most functions can be performed from the HOME screen.

1 Press the <HOME> button.

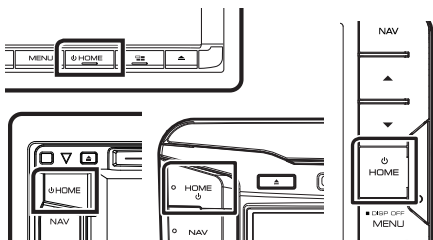

HOME screen appears.

2 Flick the screen left or right to select the widget.

Touch the widget to display the detailed screen.



■ Selecting the playback source on the HOME screen



- 1 Displays the source selection screen.
- 2 Short-cut buttons.
- 3 Displays the Hands Free screen (P.21).
- 4 Displays the control screen of current source.

1 Touch [].

Source selection screen appears.



- 1 Displays the HOME screen.
- 2 Displays the SETUP screen.

2 Flick the screen left or right to changes the page.

3 Touch source icon to changes the playback screen.

■ Customizing Short-cut buttons on HOME screen

You can arrange the position of the source icons as you like.

1 Touch and hold the icon which you want to move to go into the customizing mode.

2 Drag it where you want to move.



Basics

Common Operations

Popup menu

- 1 Press the **DNX8** **DNX7** <MENU> button/**DNX6** **DNX5** Volume knob.



Touch to display the popup menu. The contents of the menu are as follows.

- : Displays the Screen Adjustment screen.
- : Turns the display off.
- : Displays the view camera.
- : Displays the SETUP Menu screen.
- : Displays the Audio Control Menu screen.
- : Displays the control screen of current source. Icon feature differs depending on the source.

Source control screen descriptions

There are some functions which can be operated from most screens.

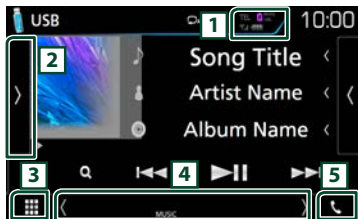

Indicators



Navigation information



Short-cut buttons

- 1 Connected Bluetooth device information.
- : Lights up when quick charging battery of the connected iPod/ iPhone/ Smartphone.
- 2 Displays the function panel (other operation button window).
- 3 Displays the source selection screen.
- 4 **[<] [>]**: The Secondary screen changes every time you touch it.
 - **Indicators**: Displays the current source condition and so on.
 - **Navigation information**: Displays the current location and the direction. The screen changes to the navigation screen when you touch here.
 - **Short-cut buttons**: The source changes to the one you have set as a short-cut. For the short-cut setting, refer to **Customizing Short-cut buttons on HOME screen (P.9)**.
- 5 Touch to display the Hands Free screen. **(P.21)**

List screen

There are some common function keys in the list screens of most sources.



- 1 Returns to previous screen.
- 2 : Displays music/movie file list.
- 3 Scrolls the displayed text.
- 4 Keys with various functions are displayed here.
 - : Plays all tracks in the folder containing the current track.
 - : Jump to the letter you entered (alphabet search).
 - : Moves to the upper hierarchy.
- 5 You can change the page to display more items by pressing .
 : Displays the top or bottom page.

Flick scrolling

You can scroll the list screen by flicking the screen up/down.

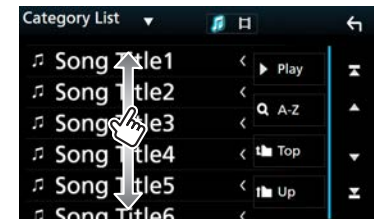

Navigation

How to Use the Navigation System

1 Press the <NAV> button to display the navigation screen.

2 Operate the desired function from the Main Menu screen.



① GPS satellite strength.

② Finds a destination.

③ Views the map.

④ Uses the Apps such as ecoRoute and Help.

⑤ Adjusts the settings.

NOTE

- You can get additional information about using the navigation system from Help. To display Help, touch [Apps] and then touch [Help].

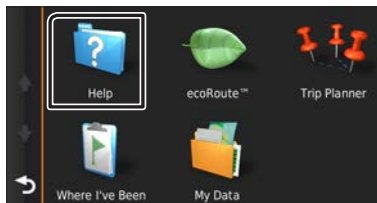

- For more information about your navigation system, download the latest version of the Owner's Manual from

<http://manual.kenwood.com/edition/im391/>

3 Enter your destination and start the guidance.

• Finding points of interest

- 1) Touch [Where To?].
- 2) Select a category and a subcategory.
- 3) Select a destination.
- 4) Touch [Go!].

NOTE

- To enter letters contained in the name, touch the Search bar and enter the letters.

4 Follow your route to the destination.

NOTICE

- The speed limit icon is for information only and does not replace the driver's responsibility to abide by all posted speed limit signs and to use safe driving judgment at all times. Garmin and JVC KENWOOD will not be responsible for any traffic fines or citations that you may receive for failing to follow all applicable traffic laws and signs.

Your route is marked with a magenta line. As you travel, your navigation system guides you to your destination with voice prompts, arrows on the map, and directions at the top of the map. If you depart from the original route, your navigation system recalculates the route.



① Views the Next Turn page or the junction view page, when available.

② Views the Turn List page.

③ Views the Where Am I? page.

④ Stops the current route.

⑤ Displays traffic information on the route.

⑥ Returns to the Main menu.

⑦ Displays a different data field.

⑧ Views the Trip Computer.

⑨ Displays more options.

NOTE

- Touch and drag the map to view a different area of the map.
- A speed limit icon could appear as you travel on major roadways.

• Adding a stop

- 1) While navigating a route, touch [] and then touch [Where To?].
- 2) Search for the extra stop.
- 3) Touch [Go!].
- 4) Touch [Add to Active Route] to add this stop before your final destination.

• Taking a detour

- 1) While navigating a route, touch [].
- 2) Touch [].

Other Features

• Manually avoiding traffic on your route

- 1) From the map, touch [].
- 2) Touch [Traffic On Route].
- 3) If necessary, touch the arrows to view other traffic delays on your route.
- 4) Touch [] > [Avoid].

• Viewing the traffic map

- 1) The traffic map shows color-coded traffic flow and delays on nearby.

Navigation

• About traffic

📎 NOTICE

- Traffic service is not available in some areas or countries.
- Garmin and JVC KENWOOD are not responsible for the accuracy or timeliness of the traffic information.
- You can receive INRIX traffic information and weather forecast by connecting your iPhone or Android smartphone in which the "KENWOOD Traffic Powered By INRIX" application is installed.
For details, see "KENWOOD Traffic Powered By INRIX" application.
- With an FM traffic receiver, the navigation system can receive and use traffic information. The FM TMC subscription activates automatically after your

navigation system acquires satellite signals while receiving traffic signals from the service provider. Go to www.garmin.com/kenwood for more information.

- While receiving INRIX traffic information, FM TMC information is not displayed.

• Updating the software

To update the navigation system software, you must have an SD card, a USB mass storage device and an internet connection.

- 1) Go to www.garmin.com/kenwood.
- 2) Select Update.
- 3) Follow the on-screen instructions.

• Updating maps

You can purchase updated map data from Garmin or ask your KENWOOD dealer or KENWOOD service center for details.

- 1) Go to www.garmin.com/kenwood.
- 2) Select Update.
- 3) Follow the on-screen instructions.

DVD/ VCD

Playing a disc

📀 Inserting a disc

DNX8 DNX7

- 1 Press the <▲> button.
- 2 Touch [DISC EJECT] to open the front panel.
- 3 Insert the disc into the slot.

The panel closes automatically and playback starts.

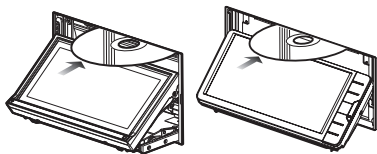

DNX5 DNX3

- 1 Insert the disc into the slot.

Playback starts.

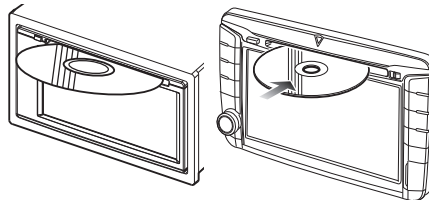

📀 Ejecting a disc

DNX8 DNX7

- 1) Press the <▲> button.
- 2) Touch [DISC EJECT] to open the front panel. When removing a disc, pull it horizontally.
- 3) Press the <▲> button.

DNX5 DNX3

- 1) Press the <▲> button.

DVD/ VCD

Playback operations

Video screen



- 1 Searches the next/previous content.
- 2 Displays the Source Control screen.

Control screen

1 Touch 2 area on the video screen.

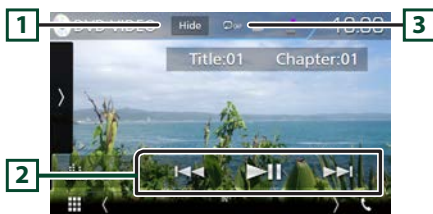

- 1 Hides the control screen.
- 2 **▶||**: Plays or pauses.
▶▶▶▶: Searches the previous/next content.
Press and hold to fast forward or fast backward. (It will be cancelled automatically after about 50 seconds.)
- 3 **↺**: Repeats the current content.

NOTE

- The control screen disappears when no operation is done for 5 seconds.

Function panel

1 Touch on the left side of the screen.



- Stops playing.
- << >>** Fast forward or fast backward. Each time you touch the key, the speed changes; 2 times, 8 times.
- <| |>** Plays in slow motion forward or backward. (DVD only)
- SETUP** Touch to display the DVD SETUP screen. (DVD only)
- MENU CTRL** Touch to display the DVD-VIDEO disc manu control screen. (DVD only)
- PBC** Turn Playback control (PBC) on or off. (VCD only)
- Audio** Change the audio output channel. (VCD only)

NOTE

- For other operations, refer to the Instruction Manual.

Video menu operations

1 Touch on the left side of the screen.

Touch [MENU CTRL].

2 Perform desired operation as follows.



- | | |
|--------------------|---|
| [TOP] * | Displays the top menu |
| [MENU] * | Displays the menu |
| [Return] * | Displays the previous menu |
| [Enter] | Enters selected item |
| [Highlight] | Enables direct operation
The menu screen disappears when no operation is done for 5 seconds. |
| [▲], [▼], [◀], [▶] | Moves the cursor |
| [Subtitle] | Switches the subtitle language |
| [Audio] | Switches the audio language |
| [Angle] | Switches the picture angle |

* These keys may not function depending on the disc.

Discs/ USB/ iPod/ SD/ APP

Preparation

NOTE

- For details about connecting Android. (P.29)
- For details about connecting iPod/iPhone. (P.28)
- Do not leave the cable or the adapter made by other makers inside the car. It might lead the malfunction caused by heat.

Connecting Android

To connect the Android device with this unit, the cable (sold separately) and the profile which your Android device supports are necessary as follows:

- To Android Auto source
 - Android version 5.0 (Lollipop) or later
 - Micro USB to USB cable
 - Automotive Mirroring: ON
 - **DNX8** **DNX7** DNX516DABS only
- To listen to music and watch video of Mirroring source
 - MHL or HDMI device
 - KCA-MH100 (MHL) or KCA-HD100 (HDMI)
 - Automotive Mirroring: OFF
 - **DNX8** **DNX7** only
- To listen to music of Bluetooth Audio source
 - Bluetooth Connection: Audio(A2DP)/App(SPP)

Connecting iPod/iPhone

To connect the iPod/iPhone with this unit, the cable, adapter (both sold separately), and the profile which your iPod/iPhone supports are necessary as follows:

- To Apple CarPlay source
 - KCA-iP103
 - Automotive Mirroring: ON
- To listen music and watch video with Lightning connector device
 - Lightning Digital AV Adapter
 - KCA-HD100
 - KCA-iP103
 - Automotive Mirroring: OFF
 - APP Connection select: iPhone Bluetooth, HDMI/MHL
 - Bluetooth Connection: Audio(A2DP)/App(SPP)
 - **DNX8** **DNX7** only
- To listen music with Lightning connector device
 - KCA-iP103
 - Automotive Mirroring: OFF
 - APP Connection select: iPhone USB
- To listen music with 30-pin connector device
 - KCA-iP102
 - Automotive Mirroring: OFF
 - APP Connection select: iPhone USB
- To listen to music via Bluetooth
 - Automotive Mirroring: OFF
 - APP Connection select: iPhone Bluetooth
 - Bluetooth Connection: Audio(A2DP)/App(SPP)

Selecting the Android/ iPod/ iPhone device to play and connection method

NOTE

- To connect an Android device or iPhone via Bluetooth, register it as the Bluetooth device and do the profile setting of the connection beforehand. (P.20)

1 Press the **DNX8** **DNX7** <MENU> button/
DNX5 **DNX3** Volume knob.

2 Touch [SETUP].

3 Touch [AV].

4 Set [Automotive Mirroring] to [OFF].

5 Touch [APP/iPod SETUP].

6 Set each item as follows.



APP Connection select

Select how to connect your smartphone.

Android Bluetooth: Connect an Android smartphone via Bluetooth.

iPhone Bluetooth: Connect an iPhone via Bluetooth.

HDMI/MHL: Connect an Android smartphone or iPhone via Bluetooth and watch its video via HDMI/MHL. **DNX8** **DNX7** only)

iPhone USB: Connect an iPhone through an USB cable.

iPod Connection

It shows how the device that is used in the iPod source is connected. It changes depending on the "APP Connection select".

7 Touch [Done].

Discs/ USB/ iPod/ SD/ APP

How to Play Music

You can play audio files from music CD, disc media, USB storage device, SD Card and iPod.

NOTE

- For details on playable file format, media format, iPod model, etc., refer to the Instruction Manual.

Connecting iPod/iPhone

- 1) Connect the iPod/iPhone.
- 2) Press the <HOME> button.
- 3) Touch [].
- 4) Touch [iPod].

NOTE

- For the details of the necessary cable and adapter to connect with iPod/iPhone, refer to "Connecting iPod/iPhone" (P.14).

To disconnect the iPod/iPhone connected with the cable:

Detach the iPod/iPhone.

Connecting a USB device

- 1) Connect the USB device with the USB cable.

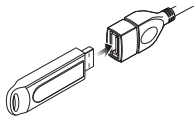

- 2) Press the <HOME> button.
- 3) Touch [].
- 4) Touch [USB].

To disconnect the USB device:

- 1) Press the <HOME> button.
- 2) Touch a source other than [USB].
- 3) Detach the USB device.

Inserting a disc

- To insert CD or DVD, refer to "Inserting a disc" (P.12).





SD card/ microSD card

- To insert SD card or microSD card, refer to "How to insert an SD Card/ microSD Card" (P.8).

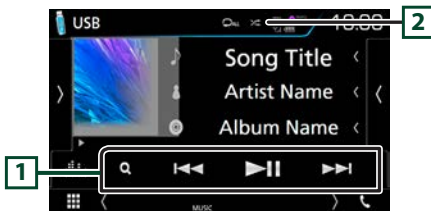
Playback operations

Control the music you are listening to on the source control screen.





- 1)  : Plays or pauses.
 : Searches the previous/next content. Press and hold to fast forward or fast backward. (It will be cancelled automatically after about 50 seconds.)
 : Searches track/file. (Disc media, iPod, USB device, and SD card only)
- 2)  : Repeats the current content.
 : Plays all contents in random order.

Function panel

1 Touch on the left side of the screen.





- 1)   : Searches previous/next folder. (disc media, USB device, and SD only)

- USB DEVICE CHANGE**      
- Switches to another USB device when two USB devices are connected. (Only for USB device of CHANGE)

Video screen



- 1)  : Searches the next/previous content.
- 2)  : Displays the Source Control screen.

NOTE

- For other operations, refer to the Instruction Manual.

Discs/ USB/ iPod/ SD/ APP

List search

- 1) Touch on the right side of the screen. The content list of the media being played is displayed.

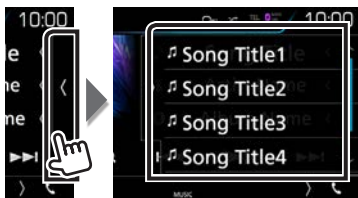

Refined search

- 1) Touch [Q].
- 2) Touch [▼].
- 3) Touch the desired refinement method.
The list is refined by the item you selected.

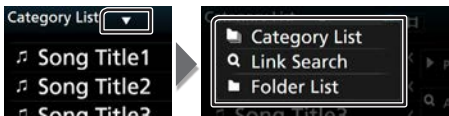

- 4) Select whether you search by audio files or video files .
- 5) Touch the desired item.

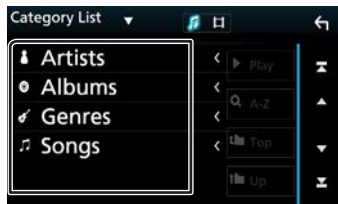

NOTE

- For details on searching operations, refer to **Search Operation (P.40)** in the Instruction Manual.

Apple CarPlay

CarPlay is a smarter, safer way to use your iPhone in the car. CarPlay takes the things you want to do with iPhone while driving and displays them on the screen of the product. You can get directions, make calls, send and receive messages, and listen to the music from iPhone while driving. You can also use Siri voice control to make it easier to operate iPhone.

For details about CarPlay, visit <https://ssl.apple.com/ios/carplay/>.

Preparation

- 1) Press the **DNX8** **DNX7** <MENU> button/ **DNX5** **DNX3** Volume knob.
- 2) Touch [SETUP].
- 3) Touch [AV].
- 4) Set each item as follows.



- **Automotive Mirroring**: Select "ON" to use Apple CarPlay.
 - **CarPlay Sidebar**: Select the position of the control bar (left or right) shown on the touch panel. "Left" (Default)/ "Right"
- 5) Connect iPhone using KCA-iP103. **(P.28)**
When iPhone compatible with CarPlay is connected to the iPod terminal, the Bluetooth smartphone currently connected is disconnected.
 - 6) Unlock your iPhone.

Operation buttons and available Apps on the home screen of CarPlay

You can use the Apps of the connected iPhone.

The items displayed and the language used on the screen differ among the connected devices.

- 1) Press the <HOME> button.
- 2) Touch .
- 3) Touch [Apple CarPlay].

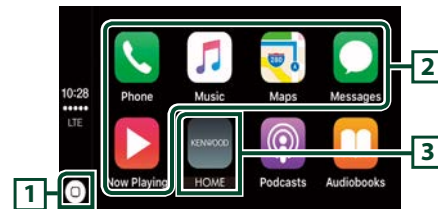

- 1) On the App screen: Displays the home screen of CarPlay.
 - On the home screen of CarPlay: Touch and hold to activate Siri.
- 2) Starts the application.
- 3) Exits the CarPlay screen and displays the Home screen.

To exit the CarPlay screen

- 1) Press the <HOME> button.

Using Siri

You can activate Siri.

- 1) Press the < > button for 1 second.
 - 2) Talk to Siri.
- **To deactivate**
 - 1) Press the < > button.

Discs/ USB/ iPod/ SD/ APP

Android Auto™

DNX877 DNX516DABS

Android Auto enables you to use functions of your Android device convenient for driving. You can easily access route guidance, make calls, listen to music, and access convenient functions on the Android device while driving.

For details about Android Auto, visit <https://www.android.com/auto/> and <https://support.google.com/androidauto>.

Preparation

Set [Automotive Mirroring] to [ON]. **(P.16)**

- 1) Connect an Android device via iPod/iPhone terminal.
(P.29)

To use the hands-free function, connect the Android device via Bluetooth.

When an Android device compatible with Android Auto is connected to the iPod/iPhone terminal, the device is connected via Bluetooth automatically, and the Bluetooth smartphone currently connected is disconnected.

- 2) Unlock your Android device.

Operation buttons and available Apps on the Android Auto screen

You can perform the operations of the Apps of the connected Android device.

The items displayed on the screen differ among the connected Android devices.

- 1) Press the <HOME> button.
- 2) Touch [].
- 3) Touch [Android Auto].

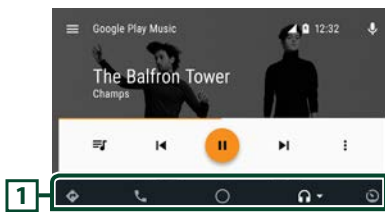

- 1) Starts the application or displays information.

To exit the Android Auto screen

- 1) Press the <HOME> button.

Using voice control

- 1) Press the <  > button for 1 second.
- #### To cancel
- 1) Press the <  > button.

Mirroring Operation DNX877

You can listen to music or watch video from the Mirroring operating on Android.

Preparation

- Set [Automotive Mirroring] to [OFF]. **(P.16)**
- The unit and the Android device are connected with MHL (KCA-MH100 ; sold separately) or HDMI (KCA-HD100 ; sold separately) and over Bluetooth profile HID and SPP.

Operation



- 1) Press the <HOME> button.
- 2) Touch [].
- 3) Touch [Mirroring].

Radio/ Digital Radio

Digital Radio Basic Operation (DNX8160DABS/ DNX716WDABS/ DNX5160DABS/ DNX516DABS)

- 1) Press the <HOME> button.
- 2) Touch [].
- 3) Touch [DAB].



- 1) Switches the seek mode in the following sequence; [AUTO1], [AUTO2], [MANUAL].
 - **AUTO1:** Tunes in an ensemble with good reception automatically.
 - **AUTO2:** Tunes in ensemble in memory one after another.
 - **MANUAL:** Switches to the next ensemble manually.
- 2) Displays the information of the current station. Touching [] allows you to switch between Content A, Content B and Content C.
- 3) The picture data is displayed if available from current content. Touch to switch between the Control and Information screen.
- 4)  : Tunes in an ensemble, service, and component. The seek mode switching can be changed. **Q** : Displays the Service List screen.
- 5) Recalls the memorized service.. When touched for 2 seconds, stores the current receiving service. in memory.
- 6) Displays the received signal strength.

Function panel

- 1) Touch on the left side of the screen.



TI	Sets the traffic information mode on.
SETUP	Displays the DAB SETUP screen.
Instant Replay	Change the Replay mode. (Live mode only)
Live	Change the Live mode. (Replay mode only)
PTY	Searches a program by setting program type.
DLS	Display the Dynamic Label Segment screen.

Recalling the preset service

- 1) Touch [P#] (#:1-15).

Service search

- 1) Touch [Q].
- 2) Select the desired content from the list.





- [] : Touch and hold to find the latest service list.
- [Q,A-Z] : Displays the keyboard screen. Jump to the letter you entered (alphabet search).

Replay

You can replay last 30 minutes of current station.

- 1) Touch [Instant Replay] on the function panel.



- 3)  : Plays or pauses.
 -  : Forward/backward 15 seconds when touch it.
 -  : Fast forward/fast backward when keep on touching. (It will be cancelled automatically after about 50 seconds.)

NOTE



- For other operations, see **Digital Radio Basic Operation (P.50)** in the Instruction Manual.

Radio/Digital Radio

Radio Basic Operation

- 1) Press the <HOME> button.
- 2) Touch [].
- 3) Touch [Radio].



- 1) Switches the seek mode in the following sequence; [AUTO1], [AUTO2], [MANUAL].
 - **AUTO1**: Tunes in a station with good reception automatically.
 - **AUTO2**: Tunes in stations in memory one after another.
 - **MANUAL**: Switches to the next frequency manually.
- 2) Displays the information of the current station. Touching [] allows you to switch between Content A and Content B.
- 3) **FM AM**: Switches the band.
- 4) : Tunes in a station. The method of frequency switching can be changed.
- 5) Recalls the memorized station. When touched for 2 seconds, stores the current receiving station in memory.

Function panel

- 1) Touch on the left side of the screen.

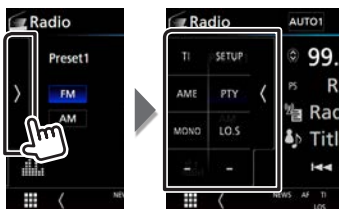

TI *1	Sets the traffic information mode on.
SETUP	Touch to display the Radio SETUP screen.
AME	Presets stations automatically.
PTY *1	Searches a program by setting program type.
MONO *1	Select the Monaural reception.
LO.S *1	Turns the Local Seek function on or off.

• *1 FM Tuner only

Auto memory

- 1) Touch [AM] or [FM] to select the band.
- 2) Touch on the left side of the screen to display the function panel.
- 3) Touch [AME].
- 4) Touch [Yes].
Auto memory starts.

Recalling the preset station

- 1) Touch [FM#] (#:1-15) or [AM#] (#:1-5).

Search by program type

- 1) Touch [PTY] on the function panel.
- 2) Select a program type from the list.
- 3) Touch [Search].

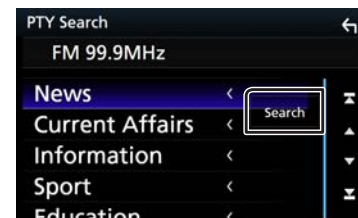

NOTE

- For other operations, see **Radio Basic Operation (P.48)** in the Instruction Manual.

Bluetooth smartphone

You can use your Bluetooth smartphone when paired to this unit.

Register your smartphone to the unit

Follow as the procedures shown below. For detailed operation, see **Registering from the Bluetooth unit (P.61)** in the Instruction Manual.

- 1 Search the unit ("DNX****") from your smartphone/cell-phone.
- 2 Confirm the request both on the smartphone/cell-phone and the unit.

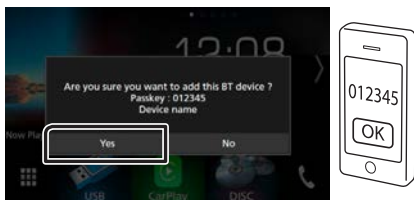

- Input the PIN code in your smartphone/cell-phone.

PIN code is set to "0000" as the default.

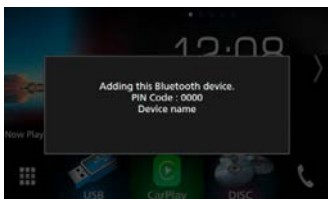

- 3 Select the hands-free number to connect.

A name of a smartphone is displayed when it has hands-

free connection with the unit.

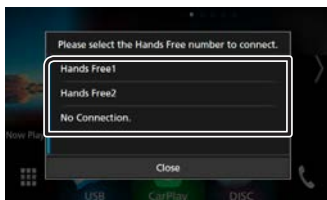

- 4 Select if you want to use the audio player app in your smartphone over A2DP, and the other apps in your smartphone over SPP.

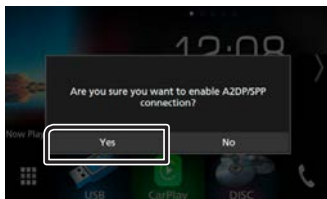

- 5 Select if you want to transfer your phonebook data.

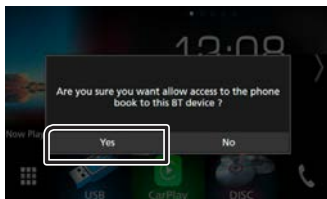

The phonebook data transmission starts.

Some smartphones may request permission to access the data. The data transmission will start with your permission.

When the data transmission and connection have completed, the Bluetooth connection icon appears on the screen.

Receive a phone call

- 1 Touch [📞].

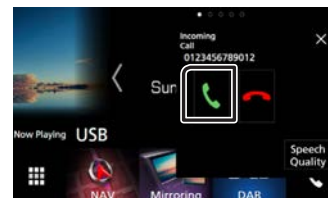

- [📞]: Reject an incoming call.

Operations during a call



- Ending a call
- Mute or not mute your voice.
- DTMF** You can send tones by touching desired keys on the screen.
- Switches the speaking voice output between cell-phone and speaker.

Bluetooth smartphone

- Speech Quality**
- **Microphone Level:** Adjust the microphone volume
 - **Echo Cancel Level:** Adjusts the level of echo cancellation.
 - **Noise Reduction Level:** Reduces the noises generated by surrounding environment without changing the microphone volume. Use this setting when the voice of caller is not clear.

x The Hands-Free popup screen is closed. To display it again, touch [📞].

- **Adjust the receiver volume**
DNX8 DNX7 Press the <▼> or <▲> button.
DNX5 DNX3 Turn the volume knob.

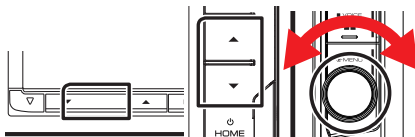

Make a phone call

1 Touch [📞].



2 Select the device to use.

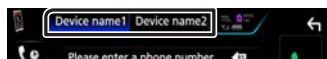

3 See the table below for each operation method.



Call by entering a phone number

- 1) Touch [📞].
- 2) Enter a phone number with number keys.
- 3) Touch [📞].

Call using call records

- 1) Touch [📞].
- 2) Select the phone number from the list.

Call using the phonebook

- 1) Touch [📞].
- 2) Touch [Q.A-Z].
- 3) Select the initial to sort the list in the alphabetical order.
- 4) Select the name from the list.
- 5) Select the number from the list.



Call using the preset number

- 1) Touch [★].
- 2) Touch the Name or phone number.

Call by voice

You can make a voice call using the voice recognition function of the cell-phone.

- 1) Touch [🗣️].
- 2) Pronounce the name registered in the cell-phone.

Phone number preset

You can register frequently used phone numbers to this unit.

- 1) Touch [★].
- 2) Touch [Edit].
- 3) Select where to preset.
- 4) Select how to preset.



- **[Add number from phonebook]:**
Select the number to preset by referring to "Call using the phonebook".
- **[Add number direct]:**
Enter the telephone number directly and touch [SET].

NOTE

- For detailed operation, see **Using Hands-Free Unit (P.66)** in the Instruction Manual.

Controlling Audio

1 Press the **DNX6** **DNX7** <MENU> button/
DNX5 **DNX3** Volume knob.

2 Touch [Audio].

Audio screen appears.



NOTE

- For detailed operation, see **Controlling Audio (P.84)** in the Instruction Manual.

Controlling General Audio

1 Touch [Fader / Balance] on the Audio screen.

2 Set each item as follows.

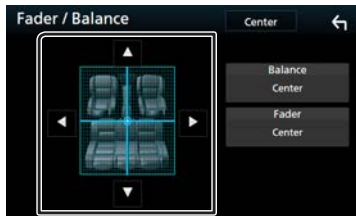

◀▶ Adjust the right and left volume balance.

▲▼ Adjust the front and rear volume balance.

Equalizer Control

1 Touch [Equalizer] on the Audio screen.

2 Touch the screen and set the Graphic Equalizer as desired.



Gain level (boxed area)

Adjust the gain level by touching the each frequency bar. You can select frequency bar and adjust its level by [▲], [▼].

Preset Select

Displays the screen to recall the preset equalizer curve.

Memory

Saves the adjusted equalizer curve to "User1" to "User4".

Initialize

The current EQ curve returns to flat.

ALL SRC

Apply the adjusted equalizer to all sources. Touch [ALL SRC] and then touch [OK] on the confirmation screen.

Bass EXT (Bass Extend Settings)

When turned on, the frequency lower than 62.5 Hz is set to the same gain level as 62.5 Hz.

SW Level

Adjusts the subwoofer volume.

Recall the EQ curve

- 1) Touch [Preset Select].
- 2) Select EQ curve.



NOTE

- [iPod] is available only during iPod source.

Save the EQ curve

- 1) Adjust the EQ curve.
- 2) Touch [Memory].
- 3) Select where to save.



Installation

Before Installation

Before installation of this unit, please note the following precautions.

⚠ WARNINGS

- If you connect the ignition wire (red) and the battery wire (yellow) to the car chassis (ground), you may cause a short circuit, that in turn may start a fire. Always connect those wires to the power source running through the fuse box.
- Do not cut out the fuse from the ignition wire (red) and the battery wire (yellow). The power supply must be connected to the wires via the fuse.

⚠ CAUTION

- Install this unit in the console of your vehicle. Do not touch the metal part of this unit during and shortly after the use of the unit. Metal part such as the heat sink and enclosure become hot.

🔧 NOTE

- Mounting and wiring this product requires skills and experience. For best safety, leave the mounting and wiring work to professionals.
- Make sure to ground the unit to a negative 12V DC power supply.
- Do not install the unit in a spot exposed to direct sunlight or excessive heat or humidity. Also avoid places with too much dust or the possibility of water splashing.
- Do not use your own screws. Use only the screws provided. If you use the wrong screws, you could damage the unit.
- If the power is not turned ON ("There is an error in the speaker wiring. Please check the connections." is displayed), the speaker wire may have a short-circuit or touched the chassis of the vehicle and the protection function may have been activated. Therefore, the speaker wire should be checked.
- If your car's ignition does not have an ACC position, connect the ignition wires to a power source that can be turned on and off with the ignition key. If you connect the ignition wire to a power source with a constant voltage supply, such as with battery wires, the battery may be drained.
- If the console has a lid, make sure to install the unit so that the

front panel will not hit the lid when closing and opening.

- If the fuse blows, first make sure the wires aren't touching to cause a short circuit, then replace the old fuse with one with the same rating.
- Insulate unconnected wires with vinyl tape or other similar material. To prevent a short circuit, do not remove the caps on the ends of the unconnected wires or the terminals.
- Connect the speaker wires correctly to the terminals to which they correspond. The unit may be damaged or fail to work if you share the ⊖ wires or ground them to any metal part in the car.
- When only two speakers are being connected to the system, connect the connectors either to both the front output terminals or to both the rear output terminals (do not mix front and rear). For example, if you connect the ⊕ connector of the left speaker to a front output terminal, do not connect the ⊖ connector to a rear output terminal.
- After the unit is installed, check whether the brake lamps, blinkers, wipers, etc. on the car are working properly.
- Mount the unit so that the mounting angle is 30° or less.
- This unit has the cooling fan to decrease the internal temperature. Do not mount the unit in a place where the cooling fan of the unit is blocked. Blocking these openings will inhibit the cooling of the internal temperature and result in malfunction.

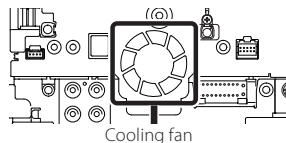

- Do not press hard on the panel surface when installing the unit to the vehicle. Otherwise scars, damage, or failure may result.
- Reception may drop if there are metal objects near the Bluetooth antenna.

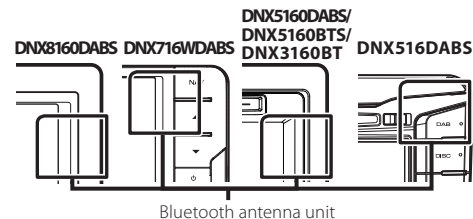

■ Supplied accessories for installation

①	x1	②	x1
③	x1	④ ^[3]	x2
⑤ ^[3]	x1	⑥	x1
⑦	x1	⑧ ^[4]	x1

^[1] DNX8160DABS, DNX716WDABS, DNX5160DABS, DNX516DABS, DNX5160BTS only

^[2] DNX3160BT only

^[3] DNX8160DABS, DNX5160DABS, DNX5160BTS, DNX3160BT only

^[4] DNX8160DABS only

Installation

■ Installation procedure

- 1) To prevent a short circuit, remove the key from the ignition and disconnect the ⊖ terminal of the battery.
- 2) Make the proper input and output wire connections for each unit.
- 3) Connect the wire on the wiring harness.
- 4) Take Connector B on the wiring harness and connect it to the speaker connector in your vehicle.
- 5) Take Connector A on the wiring harness and connect it to the external power connector on your vehicle.
- 6) Connect the wiring harness connector to the unit.
- 7) Install the unit in your car.
- 8) Reconnect the ⊖ terminal of the battery.
- 9) Perform the Initial Setup. See **Initial settings (P.5)**.

Installing the unit

■ DNX8160DABS, DNX5160DABS, DNX5160BTS, DNX3160BT

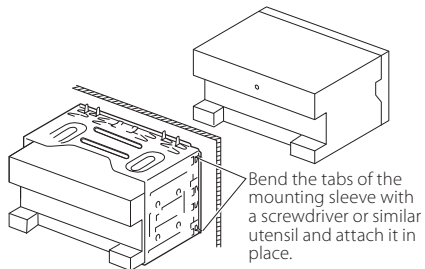

■ DNX716WDABS

Screw (M5x6mm) (Sold separately)

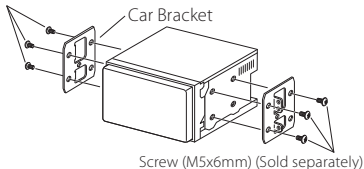

■ DNX516DABS

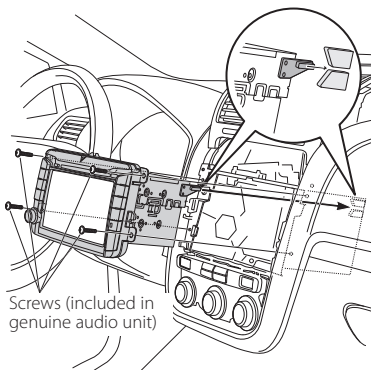

🔧 NOTE

- Make sure that the unit is installed securely in place. If the unit is unstable, it may malfunction (eg, the sound may skip).

■ Trim plate (DNX8160DABS, DNX5160DABS, DNX5160BTS, DNX3160BT)

- 1) Attach accessory ⑤ to the unit.

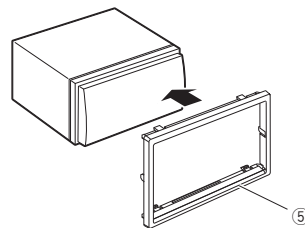

■ Microphone unit

- 1) Check the installation position of the microphone (accessory ③).
- 2) Clean the installation surface.
- 3) Remove the separator of the microphone (accessory ③), and stick the microphone to the place shown below.
- 4) Wire the microphone cable up to the unit with it secured at several positions using tape or other desired method.
- 5) Adjust the direction of the microphone (accessory ③) to the driver.

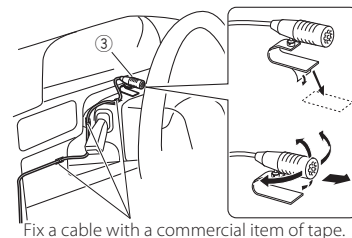

Installation

GPS antenna

GPS antenna is installed inside of the car. It should be installed as horizontally as possible to allow easy reception of the GPS satellite signals.

To mount the GPS antenna inside your vehicle:

- 1) Clean your dashboard or other surface.
- 2) Remove the separator of the metal plate (accessory ⑦).
- 3) Press the metal plate (accessory ⑦) down firmly on your dashboard or other mounting surface. You can bend the metal plate (accessory ⑦) to conform to a curved surface, if necessary.
- 4) Remove the separator of the GPS antenna (accessory ⑥), and stick the antenna to the metal plate (accessory ⑦).

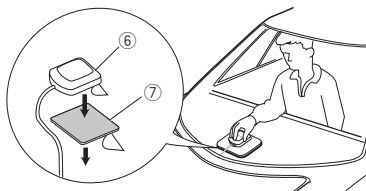

NOTE

- Depending on the type of car, reception of the GPS satellite signals might not be possible with an inside installation.
- Please install this GPS antenna in an area away from any antennas that are used with CB radios or satellite televisions.
- The GPS antenna should be installed at a position that is spaced at least 12 inch (30 cm) from cellular phone or other transmitting antennas. Signals from the GPS satellite may be interfered with by these types of communication.
- Painting the GPS antenna with (metallic) paint may cause a drop in performance.

Removing the trim plate (DNX8160DABS, DNX5160DABS, DNX5160BTS, DNX3160BT)

- 1) Engage the catch pins on the extraction key (accessory ④) and remove the two locks on the lower level. Lower the trim plate (accessory ⑤) and pull it forward as shown in the figure.

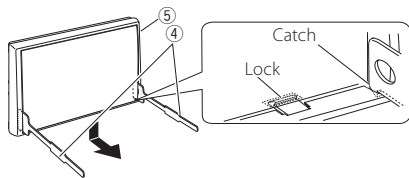

NOTE

- The trim plate can be removed from the top side in the same manner.

- 2) When the lower level is removed, remove the upper two locations.

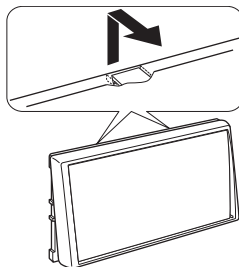

Removing the unit (DNX8160DABS, DNX5160DABS, DNX5160BTS, DNX3160BT)

- 1) Remove the trim plate by referring to step 1 in "Removing the trim plate".
- 2) Insert the two extraction keys (accessory ④) deeply into the slots on each side, as shown.

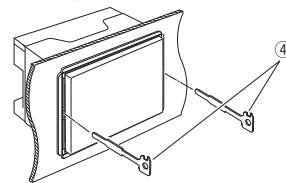

- 3) Lower the extraction key toward the bottom, and pull out the unit halfway while pressing towards the inside.

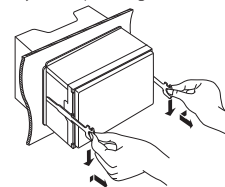

NOTE

- Be careful to avoid injury from the catch pins on the extraction key.
- 4) Pull the unit all the way out with your hands, being careful not to drop it.

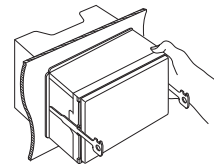

Installation

■ Connecting the system and external components

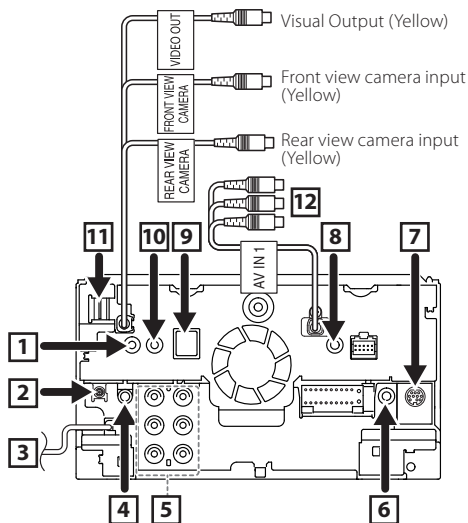

- 1 TV tuner remote output
(DNX8160DABS/ DNX716WDABS/ DNX5160DABS/
DNX516DABS/ DNX5160BTS only)
- 2 DAB antenna CX-DAB1 (Optional accessory)
(DNX8160DABS/ DNX716WDABS/ DNX5160DABS/
DNX516DABS only)



Use of a CX-DAB1 (optional accessory) as a DAB antenna is recommended.
When using a commercially available DAB antenna, the diameter of the SMB connector must be $\Phi 6.5$ mm or less.

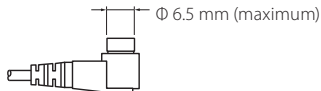

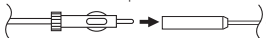
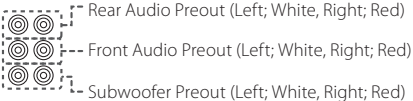
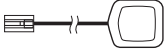
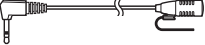
- 3 FM/AM antenna input

- 4 AV Audio output ($\phi 3.5$ mini jack)
- 5 When connecting to an external amplifier, connect its ground wire to the car's chassis to avoid damaging the unit.

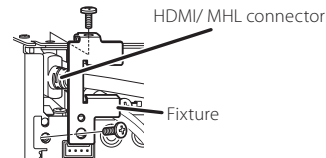
- 6 Connect to vehicle's steering remote harness. Contact your KENWOOD dealer for details.
(DNX8160DABS/ DNX716WDABS/ DNX5160DABS/
DNX516DABS/ DNX5160BTS only)
- 7 External I/F
(DNX8160DABS/ DNX716WDABS/ DNX5160DABS/
DNX516DABS/ DNX5160BTS only)
Maximum power supply current : 12 V \approx 500 mA
- 8 AV-IN2 (CA-C3AV; Optional Accessory) input
(AV-IN: DNX3160BT)
- 9 Accessory ⑥: GPS Antenna

- 10 Accessory ③: Bluetooth Microphone

- 11 HDMI/MHL input
(DNX8160DABS/ DNX716WDABS only)
MHL maximum power supply current : 5 V \approx 900 mA
When you connect the cable to HDMI/MHL terminal, remove the fixture. After connecting the cable, put the fixture again.



- 12 AV-IN1 input (Visual; Yellow, Left audio; White, Right audio; Red)
(DNX8160DABS/ DNX716WDABS/ DNX5160DABS/
DNX516DABS/ DNX5160BTS only)

Installation

■ Connecting wires to terminals

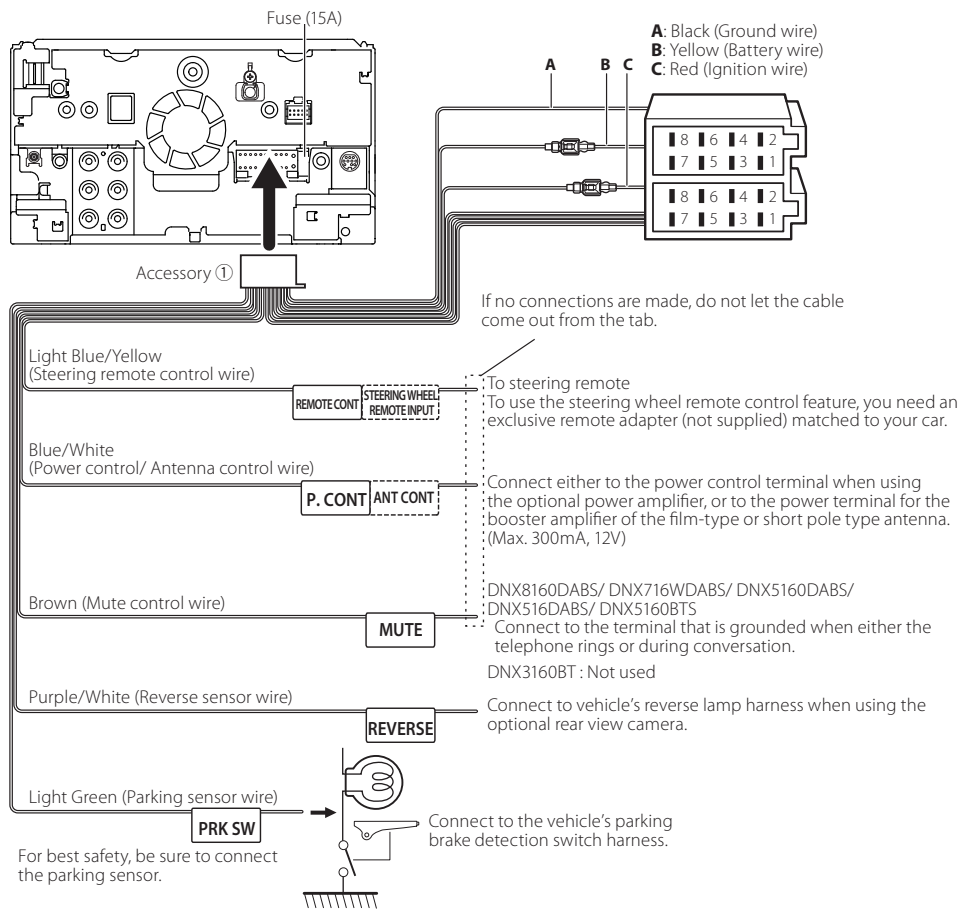

■ Wiring harness (Accessory ①) connector function guide

Pin	Color and function	
A-4	Yellow	Battery
A-5	Blue/White	Power Control
A-6	Orange/White	Dimmer
A-7	Red	Ignition (ACC)
A-8	Black	Earth (Ground) Connection
B-1/ B-2	Purple (+) / Purple/Black (-)	Rear Right
B-3/ B-4	Gray (+) / Gray/Black (-)	Front Right
B-5/ B-6	White (+) / White/Black (-)	Front Left
B-7/ B-8	Green (+) / Green/Black (-)	Rear Left

• *Speaker Impedance: 4-8 Ω

▲WARNING for Connecting the ISO Connector

The pin arrangement for the ISO connectors depends on the type of vehicle you drive. Make sure to make the proper connections to prevent damage to the unit. The default connection for the wiring harness is described in (1) below. If the ISO connector pins are set as described in (2), make the connection as illustrated. Please be sure to reconnect the cable as shown (2) below to install this unit to the **Volkswagen** vehicles etc.

(1): Default setting

The red (A-7 pin) of the vehicle's ISO connector is linked with the ignition, and the yellow (A-4 pin) is connected to the constant power supply.

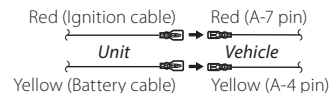

(2)

The red (A-7 pin) of the vehicle's ISO connector is connected to the constant power supply, and the yellow (A-4 pin) is linked to the ignition.

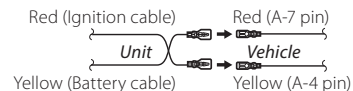

Installation

■ Connecting a USB device

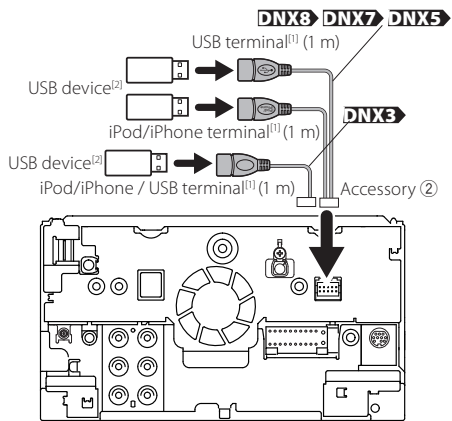

^[1]iPod/iPhone / USB maximum power supply current :
DC 5 V $\overline{\text{---}}$ 1.5 A

^[2]Sold separately / Use CA-U1EX to extend the cable if
necessary. (Max 500 mA, 5V)

■ Connecting the Wireless Display Adapter to use smartphone/iPod/iPhone over a wireless connection

Wireless Display Adapter: KCA-WL100
(Sold separately)

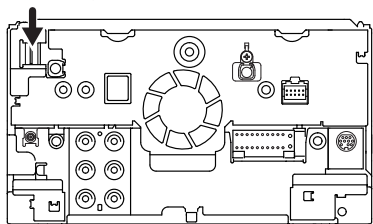

■ Connecting an iPod/iPhone

• Lightning connector

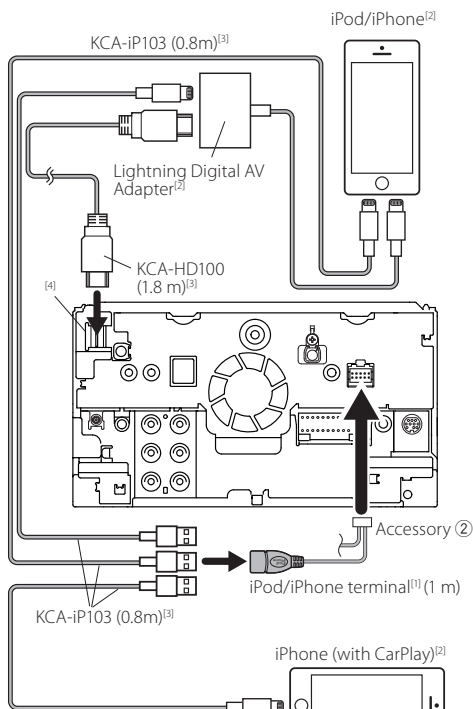

^[1]iPod/iPhone maximum power supply current :
DC 5 V $\overline{\text{---}}$ 1.5 A

^[2]Sold separately

^[3]Optional accessory

DNX8 DNX7

• 30-pin connector

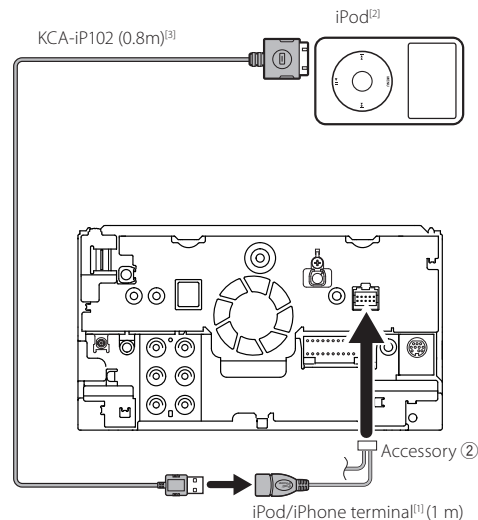

NOTE

- When you connect iPod/iPhone with HDMI cable, the necessary cable differs depended on the type of the connector like Lightning or 30-pin. Refer to "Connecting iPod/iPhone" (P.14) for the necessary cable.
- The setting is necessary to meet the connected iPod/iPhone or Android device. Refer to "Selecting the Android/iPod/iPhone device to play and connection method" (P.14).

Installation

■ Connecting an Android smartphone

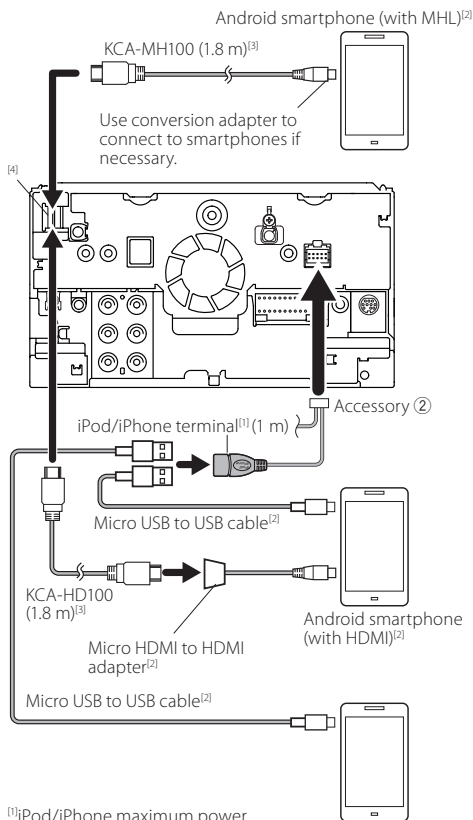

^[1]iPod/iPhone maximum power supply current : DC 5 V $\overline{\text{---}}$ 1.5 A

^[2]Sold separately

^[3]Optional accessory

^[4]**DNX8 DNX7**

^[5]**DNX8 DNX7** / DNX516DABS

About this Unit

■ Copyrights

- The Bluetooth word mark and logos are owned by the Bluetooth SIG, Inc. and any use of such marks by JVC KENWOOD Corporation is under license. Other trademarks and trade names are those of their respective owners.
- The "AAC" logo is a trademark of Dolby Laboratories.
- "Made for iPod" and "Made for iPhone" mean that an electronic accessory has been designed to connect specifically to iPod, or iPhone, respectively, and has been certified by the developer to meet Apple performance standards.

Apple is not responsible for the operation of this device or its compliance with safety and regulatory standards. Please note that the use of this accessory with iPod, or iPhone may affect wireless performance.

- iPhone, iPod, iPod classic, iPod nano, and iPod touch are trademarks of Apple Inc., registered in the U.S. and other countries.

Lightning is a trademark of Apple Inc.

- Apple, Siri, Apple CarPlay and Apple CarPlay logo are trademarks of Apple Inc., registered in the U.S. and other countries.

- **DVD** is a trademark of DVD Format/Logo Licensing Corporation registered in the U.S., Japan and other countries.

- This item incorporates copy protection technology that is protected by U.S. patents and other intellectual property rights of Rovi Corporation. Reverse engineering and disassembly are prohibited.

- Manufactured under license from Dolby Laboratories. Dolby and the double-D symbol are trademarks of Dolby Laboratories.

- INRIX is a registered trademark of INRIX, Inc.

- The terms HDMI and HDMI High-Definition Multimedia Interface, and the HDMI logo are trademarks or registered trademarks of HDMI Licensing LLC in the United States and other countries.

- MHL and the MHL logo are a trademark or registered

trademark of MHL, LLC.

- Incorporates MHL 2

- Android, Android Auto, Google Play and other marks are trademarks of Google Inc.
- BlackBerry®, RIM®, Research In Motion® and related trademarks, names and logos are the property of Research In Motion Limited and are registered and/or used in the U.S. and countries around the world. Used under license from Research In Motion Limited.
- SDHC and microSDHC Logos are trademarks of SD-3C, LLC.
- Adobe, Acrobat and Reader are either registered trademarks or trademarks of Adobe Systems Incorporated in the United States and/or other countries.
- QR Code® is registered trademarks of DENSO WAVE INCORPORATED in JAPAN and other countries.
- THIS PRODUCT IS LICENSED UNDER THE AVC PATENT PORTFOLIO LICENSE FOR THE PERSONAL USE OF A CONSUMER OR OTHER USES IN WHICH IT DOES NOT RECEIVE REMUNERATION TO (i) ENCODE VIDEO IN COMPLIANCE WITH THE AVC STANDARD ("AVC VIDEO") AND/OR (ii) DECODE AVC VIDEO THAT WAS ENCODED BY A CONSUMER ENGAGED IN A PERSONAL ACTIVITY AND/OR WAS OBTAINED FROM A VIDEO PROVIDER LICENSED TO PROVIDE AVC VIDEO. NO LICENSE IS GRANTED OR SHALL BE IMPLIED FOR ANY OTHER USE. ADDITIONAL INFORMATION MAY BE OBTAINED FROM MPEG LA, L.L.C. SEE [HTTP://WWW.MPEGLA.COM](http://WWW.MPEGLA.COM)
- THIS PRODUCT IS LICENSED UNDER THE MPEG-4 VISUAL PATENT PORTFOLIO LICENSE FOR THE PERSONAL AND NON-COMMERCIAL USE OF A CONSUMER FOR (i) ENCODING VIDEO IN COMPLIANCE WITH THE MPEG-4 VISUAL STANDARD ("MPEG-4 VIDEO") AND/OR (ii) DECODING MPEG-4 VIDEO THAT WAS ENCODED BY A CONSUMER ENGAGED IN A PERSONAL AND NON-COMMERCIAL ACTIVITY AND/OR WAS OBTAINED FROM A VIDEO PROVIDER LICENSED BY MPEG LA TO PROVIDE MPEG-4 VIDEO. NO LICENSE IS GRANTED OR SHALL BE IMPLIED FOR ANY OTHER USE. ADDITIONAL INFORMATION INCLUDING THAT RELATING TO PROMOTIONAL, INTERNAL

About this Unit

AND COMMERCIAL USES AND LICENSING MAY BE OBTAINED FROM MPEG LA, LLC. SEE [HTTP://WWW.MPEGLA.COM](http://www.mpegla.com).

- THIS PRODUCT IS LICENSED UNDER THE VC-1 PATENT PORTFOLIO LICENSE FOR THE PERSONAL AND NON-COMMERCIAL USE OF A CONSUMER TO (i) ENCODE VIDEO IN COMPLIANCE WITH THE VC-1 STANDARD ("VC-1 VIDEO") AND/OR (ii) DECODE VC-1 VIDEO THAT WAS ENCODED BY A CONSUMER ENGAGED IN A PERSONAL AND NON-COMMERCIAL ACTIVITY AND/OR WAS OBTAINED FROM A VIDEO PROVIDER LICENSED TO PROVIDE VC-1 VIDEO. NO LICENSE IS GRANTED OR SHALL BE IMPLIED FOR ANY OTHER USE. ADDITIONAL INFORMATION MAY BE OBTAINED FROM MPEG LA, L.L.C. SEE [HTTP://WWW.MPEGLA.COM](http://www.mpegla.com)

• libFLAC

Copyright (C) 2000,2001,2002,2003,2004,2005,2006,2007,2008,2009 Josh Coalson

Redistribution and use in source and binary forms, with or without modification, are permitted provided that the following conditions are met:

- Redistributions of source code must retain the above copyright notice, this list of conditions and the following disclaimer.
 - Redistributions in binary form must reproduce the above copyright notice, this list of conditions and the following disclaimer in the documentation and/or other materials provided with the distribution.
 - Neither the name of the Xiph.org Foundation nor the names of its contributors may be used to endorse or promote products derived from this software without specific prior written permission.
- THIS SOFTWARE IS PROVIDED BY THE COPYRIGHT HOLDERS AND ONTRIBUTORS "AS IS" AND ANY EXPRESS OR IMPLIED WARRANTIES, INCLUDING, BUT NOT LIMITED TO, THE IMPLIED WARRANTIES OF MERCHANTABILITY AND FITNESS FOR A PARTICULAR PURPOSE ARE DISCLAIMED. IN NO EVENT SHALL THE FOUNDATION OR CONTRIBUTORS BE LIABLE FOR ANY DIRECT, INDIRECT, INCIDENTAL, SPECIAL, EXEMPLARY, OR CONSEQUENTIAL DAMAGES (INCLUDING, BUT NOT LIMITED TO, PROCUREMENT OF SUBSTITUTE GOODS OR SERVICES; LOSS OF USE, DATA, OR PROFITS;

OR BUSINESS INTERRUPTION) HOWEVER CAUSED AND ON ANY THEORY OF LIABILITY, WHETHER IN CONTRACT, STRICT LIABILITY, OR TORT (INCLUDING NEGLIGENCE OR OTHERWISE) ARISING IN ANY WAY OUT OF THE USE OF THIS SOFTWARE, EVEN IF ADVISED OF THE POSSIBILITY OF SUCH DAMAGE.

• libvorbis

Copyright (c) 2002-2008 Xiph.org Foundation Redistribution and use in source and binary forms, with or without modification, are permitted provided that the following conditions are met:

- Redistributions of source code must retain the above copyright notice, this list of conditions and the following disclaimer.
 - Redistributions in binary form must reproduce the above copyright notice, this list of conditions and the following disclaimer in the documentation and/or other materials provided with the distribution.
 - Neither the name of the Xiph.org Foundation nor the names of its contributors may be used to endorse or promote products derived from this software without specific prior written permission.
- THIS SOFTWARE IS PROVIDED BY THE COPYRIGHT HOLDERS AND CONTRIBUTORS "AS IS" AND ANY EXPRESS OR IMPLIED WARRANTIES, INCLUDING, BUT NOT LIMITED TO, THE IMPLIED WARRANTIES OF MERCHANTABILITY AND FITNESS FOR A PARTICULAR PURPOSE ARE DISCLAIMED. IN NO EVENT SHALL THE FOUNDATION OR CONTRIBUTORS BE LIABLE FOR ANY DIRECT, INDIRECT, INCIDENTAL, SPECIAL, EXEMPLARY, OR CONSEQUENTIAL DAMAGES (INCLUDING, BUT NOT LIMITED TO, PROCUREMENT OF SUBSTITUTE GOODS OR SERVICES; LOSS OF USE, DATA, OR PROFITS; OR BUSINESS INTERRUPTION) HOWEVER CAUSED AND ON ANY THEORY OF LIABILITY, WHETHER IN CONTRACT, STRICT LIABILITY, OR TORT (INCLUDING NEGLIGENCE OR OTHERWISE) ARISING IN ANY WAY OUT OF THE USE OF THIS SOFTWARE, EVEN IF ADVISED OF THE POSSIBILITY OF SUCH DAMAGE.

• libogg

Copyright (c) 2002, Xiph.org Foundation Redistribution

and use in source and binary forms, with or without modification, are permitted provided that the following conditions are met:

- Redistributions of source code must retain the above copyright notice, this list of conditions and the following disclaimer.
 - Redistributions in binary form must reproduce the above copyright notice, this list of conditions and the following disclaimer in the documentation and/or other materials provided with the distribution.
 - Neither the name of the Xiph.org Foundation nor the names of its contributors may be used to endorse or promote products derived from this software without specific prior written permission.
- THIS SOFTWARE IS PROVIDED BY THE COPYRIGHT HOLDERS AND CONTRIBUTORS "AS IS" AND ANY EXPRESS OR IMPLIED WARRANTIES, INCLUDING, BUT NOT LIMITED TO, THE IMPLIED WARRANTIES OF MERCHANTABILITY AND FITNESS FOR A PARTICULAR PURPOSE ARE DISCLAIMED. IN NO EVENT SHALL THE FOUNDATION OR CONTRIBUTORS BE LIABLE FOR ANY DIRECT, INDIRECT, INCIDENTAL, SPECIAL, EXEMPLARY, OR CONSEQUENTIAL DAMAGES (INCLUDING, BUT NOT LIMITED TO, PROCUREMENT OF SUBSTITUTE GOODS OR SERVICES; LOSS OF USE, DATA, OR PROFITS; OR BUSINESS INTERRUPTION) HOWEVER CAUSED AND ON ANY THEORY OF LIABILITY, WHETHER IN CONTRACT, STRICT LIABILITY, OR TORT (INCLUDING NEGLIGENCE OR OTHERWISE) ARISING IN ANY WAY OUT OF THE USE OF THIS SOFTWARE, EVEN IF ADVISED OF THE POSSIBILITY OF SUCH DAMAGE.

About this Unit

Connectable iPod/iPhone

The following models can be connected to this unit.

Made for

- iPhone 6s Plus
- iPhone 6s
- iPhone 6 Plus
- iPhone 6
- iPhone 5s
- iPhone 5c
- iPhone 5
- iPhone 4s
- iPod touch (6th generation)
- iPod touch (5th generation)

About the Bluetooth smartphone and Bluetooth audio player

This unit conforms to the following Bluetooth specifications:

Version

Bluetooth Ver. 3.0

Profile

Smartphone/ Cell-phone:

HFP (V1.6) (Hands Free Profile)
SPP (Serial Port Profile)
HID (Human Interface Device Profile)
PBAP (Phonebook Access Profile)
GAP (Generic Access Profile)

Audio player:

A2DP (Advanced Audio Distribution Profile)
AVRCP (V1.5) (Audio/Video Remote Control Profile)

Sound codec

SBC, AAC

NOTE

- For the cell-phones verified for compatibility, access the following URL: <http://www.kenwood.com/cs/ce/bt/>.

Playable Audio files

(A) Bit rate : (B) Sampling frequency : (C) Bit count

- AAC-LC (.m4a)
(A) 8 – 320kbps, VBR : (B) 16 – 48 kHz : (C) 16 bit
- MP3 (.mp3)
(A) 8 – 320kbps, VBR : (B) 16 – 48 kHz : (C) 16 bit
- WMA (.wma)
(A) 8 – 320kbps : (B) 16 – 48 kHz : (C) 16 bit
- Linear PCM (WAVE) (.wav)
(A) – : (B) 16 – 48 kHz (Disc), 16 – 192 kHz (USB/ SD) :
(C) 16/ 24 bit
- FLAC (.flac)
(A) – : (B) 16 – 48 kHz (Disc), 16 – 192 kHz (USB/ SD) :
(C) 16/ 24 bit

- Vorbis (.ogg)
(A) VBR : (B) 16 – 48 kHz : (C) 16 bit

NOTE

- If music of normal CD and other playback systems are recorded in the same disc, only the playback system recorded at the first setout is played.
- WMA and AAC of which is covered with DRM cannot be played.
- Although the audio files are complied with the standards listed above, the play may be impossible depending on the types or conditions of media or device.

Acceptable Video files

Video Format (A) Profile : (B) Max. Picture size : (C) Max. bit rate)

: (D) Audio format

- MPEG-1 (.mpg, .mpeg)
(A) – : (B) 352 × 240, 352 × 288 : (C) 1.5M bps :
(D) MPEG Audio Layer 2
- MPEG-2 (.mpg, .mpeg)
(A) MP@ML : (B) 720 × 480, 720 × 576 : (C) 8M bps :
(D) MPEG Audio Layer 2
- H.264/MPEG-4 AVC (.mp4, .m4v, .avi, .flv, .f4v)
(A) Baseline Profile, Main Profile : (B) 1280 × 720 (30 fps) :
(C) 8M bps : (D) MP3, AAC
- MPEG-4 (.mp4, .avi)
(A) Advanced Simple Profile : (B) 1920 × 1080 (30 fps) :
(C) 8M bps : (D) MP3, AAC
- WMV (.wmv)
(A) Main Profile : (B) 1920 × 1080 (30 fps) : (C) 8M bps :
(D) WMA
- MKV (.mkv)
(A), (B), (C) Video Format follows H.264/MPEG-4 AVC, MPEG-4,
WMV : (D) MP3, AAC, WMA, Vorbis, FLAC

■ The marking of products using lasers

**CLASS 1
LASER PRODUCT**

The label is attached to the chassis/case and says that the component uses laser beams that have been classified as Class 1. It means that the unit is utilizing laser beams that are of a weaker class. There is no danger of hazardous radiation outside the unit.

■ Information on Disposal of Old Electrical and Electronic Equipment and Batteries (applicable for EU countries that have adopted separate waste collection systems)

Products and batteries with the symbol (crossed-out wheeled bin) cannot be disposed as household waste.

Old electrical and electronic equipment and batteries should be recycled at a facility capable of handling these items and their waste byproducts.

Contact your local authority for details in locating a recycle facility nearest to you.

Proper recycling and waste disposal will help conserve resources whilst preventing detrimental effects on our health and the environment.

Notice: The sign "Pb" below the symbol for batteries indicates that this battery contains lead.



■ מידע בדבר השלכה לאשפה של ציוד חשמלי

ואלקטרוני ישן וכן סוללות (רלוונטי למדינות

שמשמשות במערכת איסוף אשפה מופרדת).

לא ניתן להשליך מוצרים וסוללות עם הסימון (פח אשפה עם X עליו) כאשפה ביתית רגילה.

יש למחזר ציוד חשמלי ואלקטרוני ישן וכן סוללות במתקן המסוגל לטפל בפריטים כאלה ובתוצרי הלוואי שלהם.

צרו קשר עם הרשות המקומית לקבלת פריטים אודות מתקן המיחזור הקרוב אליכם. מיחזור והשלכה לאשפה נאותים יעזרו לשמר משאבים ולמנוע השפעות שליליות על בריאותנו ועל הסביבה.

שימו לב: הסימון Pb שמתחת לסימון עבור סוללות מצייין שהסוללה מכילה עופרת.





**Declaration of Conformity with regard to the EMC Directive
Declaration of Conformity with regard to the R&TTE Directive 1999/5/EC
Declaration of Conformity with regard to the RoHS Directive 2011/65/EU
Manufacturer:**

JVC KENWOOD Corporation
3-12, Moriyacho, Kanagawa-ku, Yokohama-shi, Kanagawa 221-0022, JAPAN

EU Representative:

JVCKENWOOD NEDERLAND B.V.
Amsterdamseweg 37, 1422 AC UITHOORN, The Netherlands

English

Hereby, JVC KENWOOD declares that this unit DNX8160DABS, DNX716WDABS, DNX5160DABS, DNX516DABS, DNX5160BTS, DNX3160BT is in compliance with the essential requirements and other relevant provisions of Directive 1999/5/EC.

Français

Par là présente JVC KENWOOD déclare que l'appareil DNX8160DABS, DNX716WDABS, DNX5160DABS, DNX516DABS, DNX5160BTS, DNX3160BT est conforme aux exigences essentielles et aux autres dispositions pertinentes de la directive 1999/5/CE.

Par la présente, JVC KENWOOD déclare que ce DNX8160DABS, DNX716WDABS, DNX5160DABS, DNX516DABS, DNX5160BTS, DNX3160BT est conforme aux exigences essentielles et aux autres dispositions de la directive 1999/5/CE qui lui sont applicables.

Deutsch

Hiermit erkläre JVC KENWOOD, dass sich dieser DNX8160DABS, DNX716WDABS, DNX5160DABS, DNX516DABS, DNX5160BTS, DNX3160BT in Übereinstimmung mit den grundlegenden Anforderungen und den anderen relevanten Vorschriften der Richtlinie 1999/5/EG befindet. (BMWV)

Hiermit erkläre JVC KENWOOD die Übereinstimmung des Gerätes DNX8160DABS, DNX716WDABS, DNX5160DABS, DNX516DABS, DNX5160BTS, DNX3160BT mit den grundlegenden Anforderungen und den anderen relevanten Festlegungen der Richtlinie 1999/5/EG. (Wiener)

Nederlands

Hierbij verklaart JVC KENWOOD dat het toestel DNX8160DABS, DNX716WDABS, DNX5160DABS, DNX516DABS, DNX5160BTS, DNX3160BT in overeenstemming is met de essentiële eisen en de andere relevante bepalingen van richtlijn 1999/5/EG.

Bij deze verklaart JVC KENWOOD dat deze DNX8160DABS, DNX716WDABS, DNX5160DABS, DNX516DABS, DNX5160BTS, DNX3160BT voldoet aan de essentiële eisen en aan de overige relevante bepalingen van Richtlijn 1999/5/EC.

Italiano

Con la presente JVC KENWOOD dichiara che questo DNX8160DABS, DNX716WDABS, DNX5160DABS, DNX516DABS, DNX5160BTS, DNX3160BT è conforme ai requisiti essenziali di tutte le altre disposizioni pertinenti stabilite dalla direttiva 1999/5/CE.

Español

Por medio de la presente JVC KENWOOD declara que el DNX8160DABS, DNX716WDABS, DNX5160DABS, DNX516DABS, DNX5160BTS, DNX3160BT cumple con los requisitos esenciales y cualesquiera otras disposiciones aplicables o exigibles de la Directiva 1999/5/CE.

Português

JVC KENWOOD declara que este DNX8160DABS, DNX716WDABS, DNX5160DABS, DNX516DABS, DNX5160BTS, DNX3160BT está conforme com os requisitos essenciais e outras disposições da Directiva 1999/5/CE.

Polska

JVC KENWOOD niniejszym oświadcza, że DNX8160DABS, DNX716WDABS, DNX5160DABS, DNX516DABS, DNX5160BTS, DNX3160BT spełnia zasadnicze wymogi oraz inne istotne postanowienia dyrektywy 1999/5/EC.

Český

JVC KENWOOD tímto prohlašuje, že DNX8160DABS, DNX716WDABS, DNX5160DABS, DNX516DABS, DNX5160BTS, DNX3160BT je v shodě se základními požadavky a s dalšími příslušnými ustanoveními Nařízení vlády č. 426/2000 Sb.

Magyar

Alulírott, JVC KENWOOD, kijelenti, hogy a jelen DNX8160DABS, DNX716WDABS, DNX5160DABS, DNX516DABS, DNX5160BTS, DNX3160BT megfelel az 1999/5/EC irányelvben meghatározott alapvető követelményeknek és egyéb vonatkozó előírásoknak.

Croatia

Ovim putem tvrtka JVC KENWOOD izjavljuje da je ovaj uređaj DNX8160DABS, DNX716WDABS, DNX5160DABS, DNX516DABS, DNX5160BTS, DNX3160BT unitesimin, 1999/5/EC Direktifinim bašlica gereskinimliri ve dijger iligli hūkümliri ile uyumlu olduğunu beyan eder.

Svenska

Härmed intygar JVC KENWOOD att denna DNX8160DABS, DNX716WDABS, DNX5160DABS, DNX516DABS, DNX5160BTS, DNX3160BT står i överensstämmelse med de väsentliga egenskapskrav och övriga relevanta bestämmelser som framgår av direktiv 1999/5/EG.

Suomi

JVC KENWOOD vakuuttaa täten että DNX8160DABS, DNX716WDABS, DNX5160DABS, DNX516DABS, DNX5160BTS, DNX3160BT tyyppinen laite on direktiivin 1999/5/EY oleellisten vaatimusten ja sitä koskevien direktiivin muiden ehtojen mukainen.

Slovensko

S tem JVC KENWOOD izjavlja, da je ta DNX8160DABS, DNX716WDABS, DNX5160DABS, DNX516DABS, DNX5160BTS, DNX3160BT v skladu z osnovnimi zahtevami in ostalimi ustreznimi predpisi Direktive 1999/5/EC.

Slovensky

Spoločnosť JVC KENWOOD týmto vyhlasuje, že DNX8160DABS, DNX716WDABS, DNX5160DABS, DNX516DABS, DNX5160BTS, DNX3160BT spĺňa základné požiadavky a ďalšie príslušné ustanovenia Direktívy 1999/5/EC.

Dansk

Undertegnede JVC KENWOOD erklærer herved, at følgende udstyr DNX8160DABS, DNX716WDABS, DNX5160DABS, DNX516DABS, DNX5160BTS, DNX3160BT overholder de væsentlige krav og øvrige relevante krav i direktiv 1999/5/EF.

Norsk

JVC KENWOOD erklærer herved at enheten DNX8160DABS, DNX716WDABS, DNX5160DABS, DNX516DABS, DNX5160BTS, DNX3160BT oppfyller grunnleggende krav og andre bestemmelser i direktiv 1999/5/EF.

Ελληνικά

ΜΕ ΤΗΝ ΠΑΡΟΥΣΑ JVC KENWOOD ΔΗΛΩΝΩ ΟΤΙ DNX8160DABS, DNX716WDABS, DNX5160DABS, DNX516DABS, DNX5160BTS, DNX3160BT ΣΥΜΜΟΡΦΟΝΕΤΑΙ ΠΡΟΣ ΤΙΣ ΟΥΣΙΩΔΕΙΣ ΑΠΑΙΤΗΣΕΙΣ ΚΑΙ ΤΙΣ ΛΟΙΠΕΣ ΣΧΗΤΙΚΕΣ ΔΙΑΤΑΞΕΙΣ ΤΗΣ ΟΔΗΓΙΑΣ 1999/5/ΕΚ.

Eesti

Sellela kinnitab JVC KENWOOD, et see DNX8160DABS, DNX716WDABS, DNX5160DABS, DNX516DABS, DNX5160BTS, DNX3160BT vastab direktiivi 1999/5/EC põhilistele nõudmistele ja muudele asjakohastele määrustele.

Latviešu

Ar šo, JVC KENWOOD, apstiprina, ka DNX8160DABS, DNX716WDABS, DNX5160DABS, DNX516DABS, DNX5160BTS, DNX3160BT atbilst Direktīvas 1999/5/EK galvenajām prasībām un citiem tā saucjamiem.

Lietuviškai

Šiuo, JVC KENWOOD, pareiškia, kad šis DNX8160DABS, DNX716WDABS, DNX5160DABS, DNX516DABS, DNX5160BTS, DNX3160BT atitinka pagrindinius Direktyvos 1999/5/EB reikalavimus ir kitas svarbias nuostatas.

Malti

Hawnhekk, JVC KENWOOD, jidjikkara li dan DNX8160DABS, DNX716WDABS, DNX5160DABS, DNX516DABS, DNX5160BTS, DNX3160BT jikkonforma mal-htigijiet essenzjali u ma provvedimenti oħrajn relevanti li hemm fid-Direttiva 1999/5/EC.

Українська

Компанія JVC KENWOOD заявляє, що цей виріб DNX8160DABS, DNX716WDABS, DNX5160DABS, DNX516DABS, DNX5160BTS, DNX3160BT відповідає ключовим вимогам та іншим пов'язаним положенням Директиви 1999/5/EC.

Türkçe

Bu vesileyle JVC Kenwood, DNX8160DABS, DNX716WDABS, DNX5160DABS, DNX516DABS, DNX5160BTS, DNX3160BT vđıldođude klavchovim vımogam ta ınlımm pov'yzanim polozhenıam Dırekıtvını bařlica gereskinimliri ve dijger iligli hūkümliri ile uyumlu olduğunu beyan eder.

HDMI™
HIGH-DEFINITION MULTIMEDIA INTERFACE

MHL™

DAB+
Digital Audio Broadcasting

DVD
VIDEO

DOLBY
DIGITAL



SD
HD

micro
SD
HD

Bluetooth®

Made for
 iPod iPhone

Works with
Apple CarPlay

Designed for
Windows
Media™

android
auto

KENWOOD