

DNX4150BT DNX4150BTM DNX4150DAB

GPS NAVIGATION SYSTEM INSTRUCTION MANUAL

JVC KENWOOD Corporation

Before reading this manual, click the button below to check the latest edition and the modified pages.

<http://manual.kenwood.com/edition/im386/>





What Do You Want To Do?

Thank you for purchasing the KENWOOD GPS NAVIGATION SYSTEM.
In this manual, you will learn various convenient functions of the system.

Click the icon of the media you want to play.

With one-click, you can jump to the section of each media!

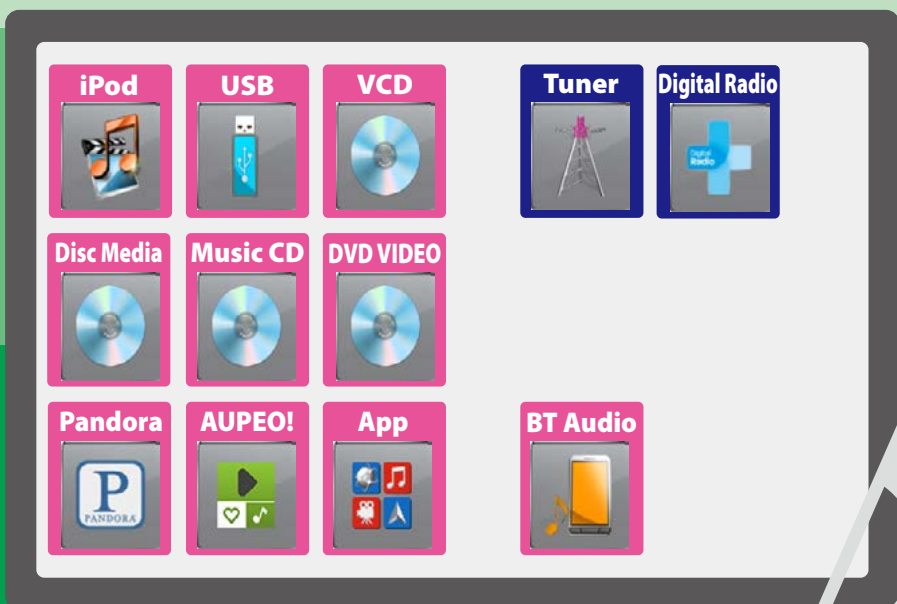

Contents

Before Use	4	Radio Operation	50
▲ WARNING _____	4	Radio Basic Operation _____	50
How to Read this Manual	5	Digital Radio Basic Operation (DNX4150DAB only) _____	52
Basic Operations	6	Memory Operation _____	54
Functions of the Buttons on the Front Panel _____	6	Selecting Operation _____	55
Turning on the Unit _____	8	Traffic Information (FM tuner and Digital Radio only) _____	56
How to Play Media _____	10	Replay (Digital Radio only) _____	57
Operating with the HOME Screen _____	12	Tuner Setup _____	58
Common Operations _____	14	Digital Radio Setup _____	59
Navigation Operation _____	16	Bluetooth Control	62
DVD/Video CD (VCD) Operation	18	Registering And Connecting Bluetooth Unit _____	62
DVD/VCD Basic Operation _____	18	Playing Bluetooth Audio Device _____	66
DVD Disc Menu Operation _____	21	Using Hands-Free Unit _____	67
Zoom Control For DVD And VCD _____	22	Hands-Free Setup _____	70
DVD Setup _____	24	Setting Up	72
CD/Audio and Visual Files/ iPod/App Operation	28	Monitor Screen Setup _____	72
Music/Video/Picture Basic Operation _____	28	System Setup _____	73
Search Operation _____	34	Display Setup _____	79
Movie Control _____	37	Navigation Setup _____	81
Pandora® Operation (region code 4 area only) _____	38	Camera Setup _____	82
AUPEO! Operation _____	41	Software Information _____	83
Apps Operation _____	43	AV Input Setup _____	84
USB/iPod/DivX Setup _____	44	AV Output Interface Setup _____	84

Controlling Audio **86**

Setting Audio _____ 86
Controlling General Audio _____ 90
Equalizer Control _____ 91
Zone Control _____ 92
Sound Effect _____ 93
Listening Position _____ 96

Remote control **98**

Battery Installation _____ 98
Functions of the Remote control Buttons _____ 99

Troubleshooting **102**

Problems and Solutions _____ 102
Error Messages _____ 103
Resetting the Unit _____ 105

Appendix **106**

Playable Media and Files _____ 106
Status Bar Indicator Items _____ 110
Region Codes in the World _____ 112
DVD Language Codes _____ 113
Specifications _____ 114
About this Unit _____ 117

Before Use

⚠ WARNING

To prevent injury or fire, take the following precautions:

- To prevent a short circuit, never put or leave any metallic objects (such as coins or metal tools) inside the unit.
- Do not watch or fix your eyes on the unit's display when you are driving for any extended period.
- If you experience problems during installation, consult your Kenwood dealer.

Precautions on using this unit

- When you purchase optional accessories, check with your Kenwood dealer to make sure that they work with your model and in your area.
- You can select language to display menus, audio file tags, etc. See [Language setup \(P.75\)](#).
- The Radio Data System or Radio Broadcast Data System feature won't work where the service is not supported by any broadcasting station.

Protecting the monitor

To protect the monitor from damage, do not operate the monitor using a ball point pen or similar tool with the sharp tip.

Cleaning the unit

If the faceplate of this unit is stained, wipe it with a dry soft cloth such as a silicon cloth. If the faceplate is stained badly, wipe the stain off with a cloth moistened with neutral cleaner, then wipe it again with a clean soft dry cloth.



- Applying spray cleaner directly to the unit may affect its mechanical parts. Wiping the faceplate with a hard cloth or using a volatile liquid such as thinner or alcohol may scratch the surface or erase screened print.

Lens fogging

When you turn on the car heater in cold weather, dew or condensation may form on the lens in the disc player of the unit. Called lens fogging, this condensation on the lens may not allow discs to play. In such a situation, remove the disc and wait for the condensation to evaporate. If the unit still does not operate normally after a while, consult your Kenwood dealer.

Precautions on handling discs

- Do not touch the recording surface of the disc.
- Do not stick tape etc. on the disc, or use a disc with tape stuck on it.
- Do not use disc type accessories.
- Clean from the center of the disc and move outward.
- When removing discs from this unit, pull them out horizontally.
- If the disc center hole or outside rim has burrs, use the disc only after removing the burrs with a ballpoint pen etc.
- Discs that are not round cannot be used.

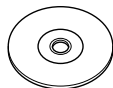

- 8-cm (3 inch) discs cannot be used.
- Discs with coloring on the recording surface or discs that are dirty cannot be used.

- This unit can only play the CDs with



This unit may not correctly play discs which do not have the mark.

- You cannot play a disc that has not been finalized. (For the finalization process see your writing software, and your recorder instruction manual.)

How to Read this Manual

[Return to the Top page](#)

[CD/Audio and Visual Files/iPod/App Operation](#)

Search Operation

You can search music, video or picture files by the following operations.

NOTE

- If you use a remote control, you can jump directly to the desired track/file with entering the track/folder/file number, play time, etc. For details, see [Direct search mode \(P.119\)](#).

List search

You can search tracks, folders, and files according to hierarchy.

1 Touch [Q].

The search type screen appears.

2 Touch desired search way.

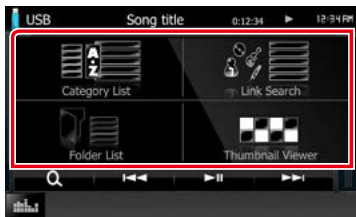

List Control screen appears.

3 Touch the desired folder.



4 Touch desired item from the content list.

Playback starts.

Other search

When you want to narrow the list down, there are other search ways.

This function is not available when music CD is the current source.

30

Link header

You can refer each section or top page with one-click.

Operation title

Introduces the function.

NOTE

Introduces some tips, notes, etc.

Reference mark

Displayed in blue notes.

With one-click, you can jump to the article related to the current section.

Operation procedure

Explains necessary procedures to achieve the operation.

< >: Indicates the name of panel buttons.

[]: Indicates the name of touch keys.

Screen shot

Shows some screen shots displayed during operation for reference.

The area or keys to touch are surrounded with a red frame.

NOTE

- The screens and panels shown in this manual are examples used to provide clear explanations of the operations. For this reason, they may be different from the actual screens or panels used, or some display patterns may be different.

Basic Operations

Functions of the Buttons on the Front Panel

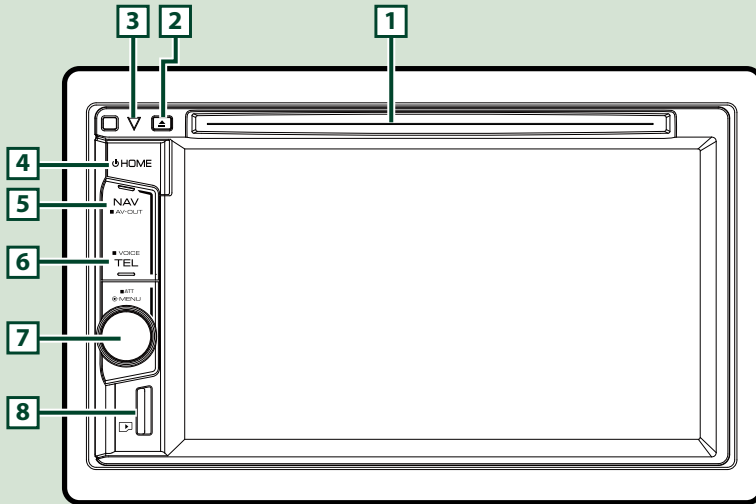

NOTE

- The panels shown in this guide are examples used to provide clear explanations of the operations. For this reason, they may be different from the actual panels.

How to insert a microSD Card

- 1) Hold the microSD card with the label side facing right and the notched section down, and insert it into the **8** slot until it clicks.

● To eject the card:

Push the card until it clicks and then remove your finger from the card.
The card pops up so that you can pull it out with your fingers.

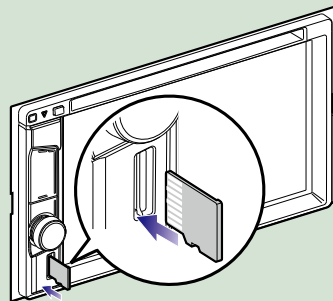

Number	Name	Motion
1	Disc insert slot	<ul style="list-style-type: none"> • A slot to insert a disc media.
2	▲ (Eject)	<ul style="list-style-type: none"> • Ejects the disc. • Pressing for 1 second ejects the disc forcibly.
3	▽ (Reset)	<ul style="list-style-type: none"> • If the unit or the connected unit fails to operate properly, the unit returns to factory settings when this button is pressed (P.105). • If the Security Indicator (SI) function is turned on, this indicator flashes when the panel is detached (P.77).
4	HOME	<ul style="list-style-type: none"> • Displays the HOME screen (P.12). • Pressing for 1 second turns the power off. • When the power off, turns the power on.
5	NAV	<ul style="list-style-type: none"> • Displays the navigation screen. • Pressing for 1 second switches AV out sources.
6	TEL	<ul style="list-style-type: none"> • Displays the Hands Free screen (P.67). • Pressing for 1 second displays the Voice Recognition screen. (P.70) *
7	Volume Knob	<ul style="list-style-type: none"> • Turning adjusts volume up or down. • Displays the option menu screen. • Pressing for 1 second switches attenuation of the volume on/off.
8	microSD card slot	<ul style="list-style-type: none"> • A microSD card slot for upgrading the map. For how to upgrade the map, refer to the instruction manual of the navigation system.

* [TEL] button can also be used to switch to the rear view camera or turn off the display. See [User interface \(P.74\)](#).

Turning on the Unit

The method of turning on is different depending on the model.

- 1 Press the <HOME> button.

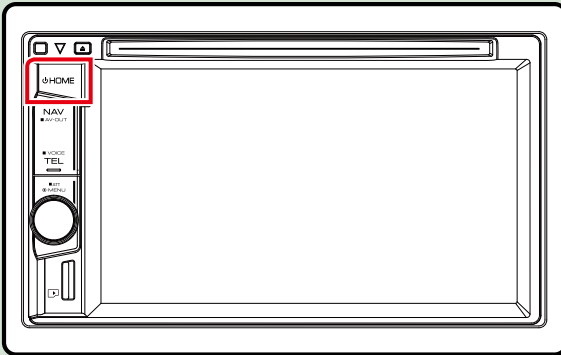

The unit is turned on.

- **To turn off the unit:**
Press the <HOME> button for 1 second.

If it is your first time turning the unit on after installation, it will be necessary to perform [Initial setup \(P.8\)](#).

Initial setup

Perform this setup when you use this unit first time or when you reset the unit ([P.105](#)).

- 1 Set each item as follows.



Locale

Select the country for the navigation system.

The language, the distance unit, and the gasoline unit are set.

After setting, touch [Enter].

- ① Touch [SET].
- ② Select the desired country.

Language

Select the language used for the control screen and setting items. Default is "British English (en)".

- ① Touch [SET].
- ② Touch [◀] or [▶] to select the desired language.
- ③ Touch [Enter].

For detailed operation, see [Language setup \(P.75\)](#).

Color

Set the screen and button illumination color. You can select whether to allow color scan operation or select a fixed color for operation.

- ① Touch [SET].
- ② Touch [ON] or [OFF] of [Panel Color Scan].
- ③ If you want to change color, touch [SET] of [Panel Color Coordinate].
- ④ Touch your desired color and [↵].

For detailed operation, see [Panel color coordinate \(P.79\)](#).

Camera

Set the parameters for the camera.

- ① Touch [SET].
- ② Set each item and touch [↵].

For detailed operation, see [Camera Setup \(P.82\)](#).

DEMO

Set the demonstration mode. Default is "ON".

- ① Touch [ON] or [OFF].

2 Touch [Finish].

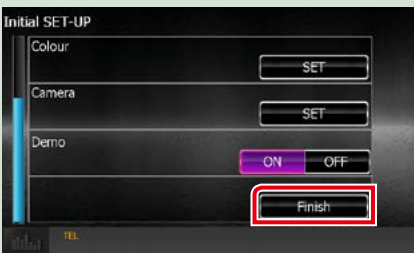

NOTE

- These settings can be set from the SETUP menu. See [Setting Up \(P.72\)](#).

How to Play Media

Music CD and disc media

- 1 Insert the disc into the slot.

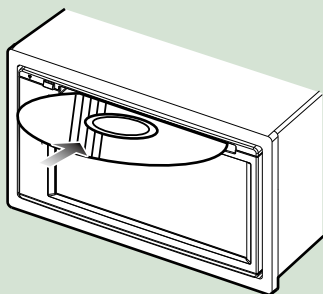

The unit loads the disc and playback starts.

- **To eject the disc:**
Press the <▲> button.

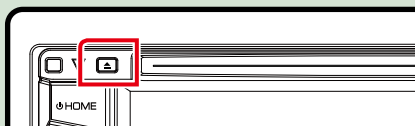

USB device

- 1 Connect the USB device with the USB cable.

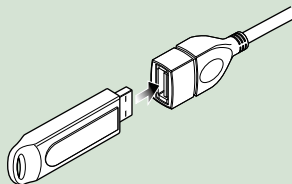

The unit reads the device and playback starts.

- **To disconnect the device:**
Touch screen from the left end to display the function panel.
Touch [▲]. Disconnect the device from the cable.

iPod

- 1 Connect the iPod.
- 2 Press the <HOME> button.
- 3 Touch [iPod] in the HOME screen. [\(P.12\)](#)

NOTE

- For the details of the necessary cable and adapter to connect with iPod/iPhone, refer to [Music/Video/Picture Basic Operation \(P.28\)](#).

- **To disconnect the iPod/iPhone connected with the cable:**
Touch screen from the left end to display the function panel.
Touch [▲]. Disconnect the iPod/ iPhone from the cable.

HDMI/ MHL source

You can display the screen of smartphones connected via the HDMI/MHL input terminal.

- 1 Press the <HOME> button.
- 2 Touch [HDMI/ MHL] in the HOME screen. [\(P.12\)](#)
- 3 Start an application or playback on your smartphone.

● About Miracast Dongles:

This unit is compatible with Miracast Dongles. Connecting a Miracast Dongle (KCA-WL100: optional accessory) to the HDMI/MHL input terminal enables you to enjoy listening to music, watching videos, or viewing pictures over a wireless connection.

NOTE

- For details about Miracast Dongle settings, etc., refer to the instructions supplied with the Miracast Dongle.

TV tuner

You can connect the TV tuner (commercially available) with this unit and watch TV.

Before use

- When you use TV control function, connect the TV tuner (commercially available) and set 3rd Party TV Tuner Control in [AV Input Setup \(P.84\)](#) to ON.
- The TV tuner can be controlled with its supplied remote control through the remote sensor on the front panel of this unit.

- 1 Press the <HOME> button.
- 2 Touch [TV] in the HOME screen. [\(P.12\)](#)

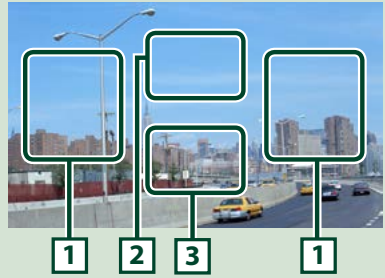

1 Switching channel area

Touch to switch the channel.

2 Menu display area

Touch to display the Menu control screen.

3 Key display area

Touch to display the control screen.

Menu control screen:

Touch **2** Menu display area to set the menu of the TV tuner.



Displays the menu/ Enters selected item

Touch [MENU/OK].

Moves the cursor

Touch [▲], [▼], [◀], [▶].

Exits menu control

Touch [Exit].

Operating with the HOME Screen

Most functions can be performed from the HOME screen.

1 Press the <HOME> button.

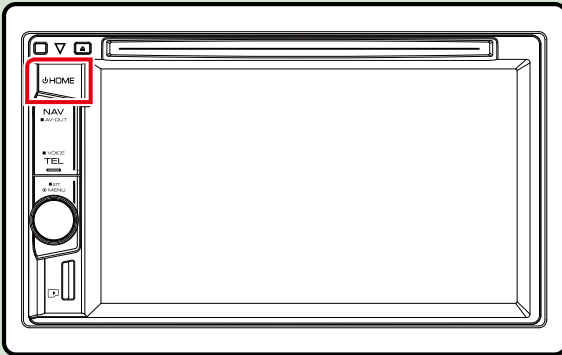

HOME screen appears.



NOTE

• HOME screen can be changed by flicking left or right.

● Customizing HOME screen





You can arrange the position of the source icons as you like.

1. Touch and hold the icon which you want to move to go into the customizing mode.
2. Drag it where you want to move.

Customizing mode screen

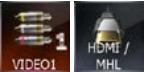
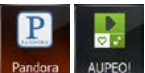

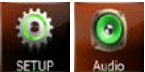
From this screen, you can perform the following functions.

Function	Icon	Operation
Switch the audio source	 USB iPod TUNER Digital Radio etc.	Touch the icon of the desired source.
Switch the video source	 VIDEO1 HDMI / MHL etc.	Touch the icon of the desired video source.
Switch the application installed in the iPhone/iPod or Android.	 Pandora AUPEQ!	Touch the icon of the desired application.
Switch the App source	 APPS	Touch the icon of the desired App source.
Enter setup mode	 SETUP Audio etc.	Touch the icon of the desired setup function.
Display navigation screen	 NAV or 0.5 mi → Sunset Blvd	Touch [NAV] or navigation information.
Turn off all audio function	 STANDBY	Touch [STANDBY].

Common Operations

Introduces the common operations.

Pop up menu

1 Press the volume knob.

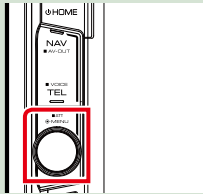

Pop up menu appears.



Touch to display the popup menu. The contents of the menu are as follows.

- : Displays the Screen Adjustment screen.
- : Turns the display off.
- : Displays the camera view.
- : Displays the SETUP Menu screen.
- : Displays the Audio Control Menu screen.
- : Displays the control screen of current source. Icon feature differs depending on the source.

General

There are some functions which can be operated from most screens.



(Graphic Equalizer)

Displays Graphic Equalizer screen.

(RETURN)

Returns to previous screen.

(Common menu key)

Touch to display the common menu. The contents of the menu are as follows.

- : Displays the SETUP Menu screen.
- : Displays the Audio Control Menu screen.
- : Displays the control screen of current source. Icon feature differs depending on the source.
- : Closes the menu.

List screen

There are some common function keys in the list screens of most sources.



◀ (Scroll)

Scrolls the displayed text.

All ▶ etc.

Touch keys with various functions are displayed here. Displayed keys differ depending on the current audio source, status, etc. For examples of functions of each key, refer to the table below.

Key	Function
All ▶	Lists all the music in the lower hierarchy.
◀ ▶	Moves to the upper hierarchy.
🎵	Displays current category folder.
🎵 🖼️ 📄	Displays music/picture/movie file list.

Flick scrolling

You can scroll the list screen by flicking the screen up/down or right/left.

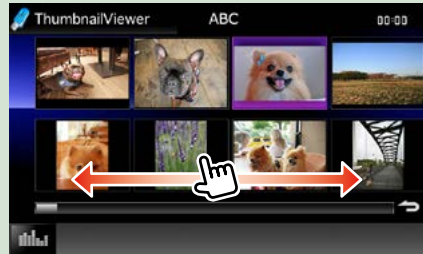

Navigation Operation

For details on the navigation function, please refer to the Navigation Instruction Manual.

Display the navigation screen

- 1 Press the <NAV> button.



The navigation screen appears.

Control audio from the navigation screen

You can control audio sources while the navigation screen is displayed.

Also, you can view the navigation information while the source control screen is displayed.

- 1 Touch the information bar.

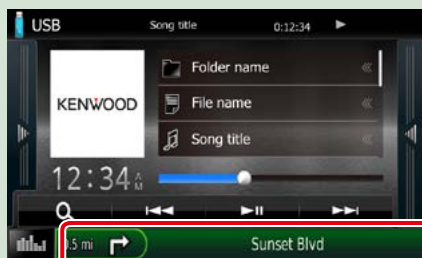

The navigation screen with audio information appears.

2 Touch [] or [] in the navigation screen.



Touching this area displays the audio screen.

 : Displays the navigation and control keys of the current source.



 : Displays the navigation and current video/picture playback display.



NOTE

- The screen switches between playback screen and camera view each time the viewing area is touched.
- Touching the source icon in the bottom of the screen displays the full audio screen.

● To return to the full navigation screen:

Touch [].

NOTE

- For details on control keys, refer to the instructions in each section.

DVD/Video CD (VCD) Operation

DVD/VCD Basic Operation

Most functions can be controlled from the source control screen and playback screen.

NOTE

- Set the remote control mode switch to DVD mode before starting operation, see [Switching the operation mode \(P.99\)](#).
- The screen shot below is for DVD. It may be different from the one for VCD.

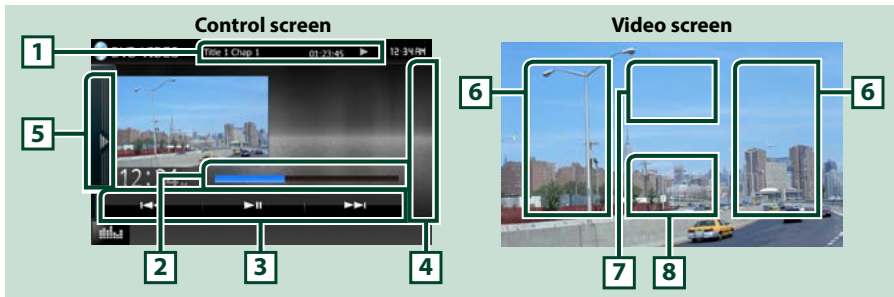

1 Information display

Displays the following information.

- **Title #, Chap #:** DVD title and chapter number display
- **Track #/Scene #:** VCD track or scene number display
Scene # is displayed only when Playback control (PBC) is on.
- **▶, ▶▶, ▶▶▶, ■, etc.:** Current play mode display
The meanings of each icon are as follows; ▶ (play), ▶▶ (fast forward), ◀◀ (fast backward), ▶▶▶ (search up), ◀◀◀ (search down), ■ (stop), **R** (resume stop), || (pause), |▶ (slow playback), ◀| (slow reverse playback).

Touch this area to display the disc label name.

2 Status bar (DVD only)

For confirmation of current playing position.

3 Function bar

Various functions can be performed by using keys in this area. For details on the keys, see [Function bar \(P.19\)](#).

4 Control list

Unavailable in DVD/VCD source.

5 Function panel

Touch on the left side of the screen to display the function panel. Touch again to close the panel. For details on the keys, see [Function panel \(P.20\)](#).

6 Searching area

Touch to search the next/previous content.

Scrolling from center of display to left or right performs fast backward or fast forward. Each time you touch each area, the speed changes; standard, 2 times, 3 times. To stop fast backward/forward, touch center of the display.

7 Menu display area

This area functions differently depending on the current status.

- **During DVD playback:** Displays the DVD menu. During the menu display, displays the highlight control screen.
- **During VCD playback:** Displays the Zoom Control screen ([P.22](#)).

8 Key display area

Touch to display the control screen.

NOTE

- If you use a remote control, you can jump directly to the desired image with entering the chapter number, scene number, play time, etc. ([P.99](#)).

Function bar

DVD



VCD



The functions of each key are as follows.

[<<<] [>>>]

Searches the previous/next content.

[▶ II]

Plays or pauses.

Function panel

1 Touch on the left side of the screen.

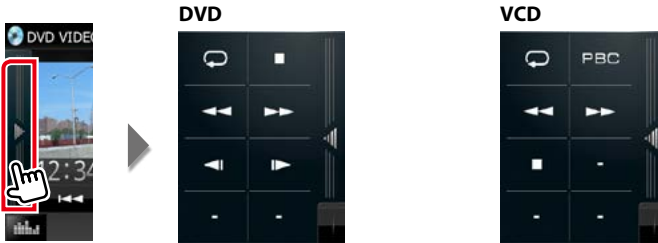



The functions of each key are as follows.



Repeats the current content. Each time you touch the key, repeat mode switches in the following sequence;

DVD: "title repeat" , "chapter repeat" , "function off" 

VCD (PBC On): Does not repeat

VCD (PBC Off): "track repeat" , "function off" 



Stops playback. When touched twice, the disc is played from the beginning when you play it the next time.

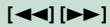

Fast forward or fast backward. Each time you touch the key, the speed changes; standard, 2 times, 3 times.

[◀|] or [I▶] (DVD only)

Plays in slow motion forward or backward.

[PBC] (VCD only)

Turn Playback control (PBC) on or off.

DVD Disc Menu Operation

You can set up some items in the DVD-VIDEO disc menu.

1 Touch illustrated area during playback.



Menu Control screen appears.

2 Perform desired operation as follows.



Displays the top menu

Touch [Top].*

Displays the menu

Touch [Menu].*

Displays the previous menu

Touch [Return].*

Enters selected item

Touch [Enter].

Enables direct operation

Touch [Highlight] to enter the highlight control mode ([P.21](#)).

Moves the cursor

Touch [▲], [▼], [◀], [▶].

*These keys may not function depending on the disc.

Highlight control

Highlight control lets you control the DVD menu by touching the menu key directly on the screen.

1 Touch [Highlight] in the Menu Control screen.

2 Touch desired item on the screen.



NOTE

- The highlight control is cleared automatically if you do not operate for a constant time.

DVD play mode setting

You can select DVD play mode.

- 1 Touch [Next] in the Menu Control screen.



Menu Control 2 screen appears.

- 2 Touch the key which corresponds to desired setting item.



Switches the subtitle language

Touch [Subtitle]. Each time you touch this key, language is switched.

Switches the audio language

Touch [Audio]. Each time you touch this key, language is switched.

Controls zoom ratio

Touch [Zoom]. For details, see [step 2 in Zoom Control For DVD And VCD \(P.22\)](#).

Switches the picture angle

Touch [Angle]. Each time you touch this key, picture angle is switched.

Exits menu control

Touch [Exit].

Displays the Menu Control 1 screen

Touch [Previous].

Zoom Control For DVD And VCD

You can enlarge Playback screen for DVD and VCD.

- 1 For VCD, touch illustrated area during playback.



Zoom Control screen appears.

NOTE

- For DVD, please refer to [DVD play mode setting \(P.22\)](#) to display the Zoom Control screen.

- 2 Perform desired operation as follows.



Switches zoom ratio

Touch [Zoom].

For DVD, changes the zoom ratio at 4 levels; Off, 2 times, 3 times, 4 times.

For VCD, changes the zoom ratio at 2 levels; Off, 2 times.

Scrolls the screen

Touch [▲], [▼], [◀], or [▶] to scroll the screen in the direction you touch.

Exits menu control

Touch [Exit].

Displays the previous menu*

Touch [Return].

***This function may not be performed depending on the disc.**

NOTE

- You cannot touch the menu keys directly on the screen when zooming.

DVD Setup

You can set up the DVD playback functions.

NOTE

- Each operation in this section can be started from the HOME screen. For details, see [Operating with the HOME Screen \(P.12\)](#).
- Some setup items can only be set in standby mode.

1 Press the volume knob.

Pop up menu appears.

2 Touch [SETUP].

SETUP Menu screen appears.

3 Touch [Source].

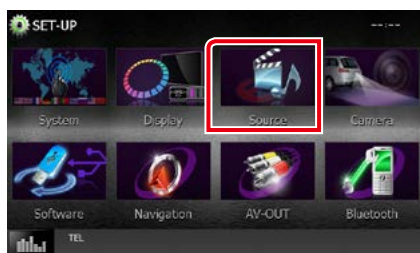

Source SETUP Menu screen appears.

4 Touch [DVD SETUP] in the list.

DVD SETUP screen appears.

5 Set each item as follows.



Menu/Subtitle/Audio Language*

See [Language setup \(P.25\)](#).

Dynamic Range Control*

Sets the dynamic range.

Wide: The dynamic range is wide.

Normal: The dynamic range is normal.

Dialog (Default): Makes the total sound volume larger than other modes. This is effective only when you are using Dolby Digital software.

Angle Mark

Sets an angle mark display.

ON (Default): An angle mark appears.

OFF: An angle mark does not appear.

Screen Ratio*

Sets the screen display mode.

16:9 (Default): Displays wide pictures.

4:3 LB: Displays wide pictures in the Letter Box format (having black stripes at the top and bottom of screen).

4:3 PS: Displays wide pictures in the Pan & Scan format (showing pictures cut at the right and left ends).

Parental Level*

See [Parental level \(P.26\)](#).

DISC SETUP

See [Disc setup \(P.26\)](#).

Stream Information

Displays the present source information.

The stream (Dolby Digital, dts, Linear PCM, MPEG, WMA or AAC) appears.

* These items are disabled when a DVD is inserted.

Language setup

This setting is for the language used in the menu, subtitle, and voice. You cannot setup these items during DVD playback.

1 Touch [SET] of the desired item; [Menu Language], [Subtitle Language], [Audio Language].

Language Set screen appears.

2 Enter the desired language code and touch [Enter].



For language code, refer to [DVD Language Codes \(P.113\)](#).

Sets the entered language and returns to the DVD SETUP screen.

NOTE

- To cancel the setup and return to the previous screen, touch [Cancel].
- To clear the entered code, touch [Clear].
- To set the DVD's original language for audio language, touch [Original].

Parental level

Sets a parental level. You cannot setup this item during DVD playback.

- 1 **Touch [SET] of [Parental Level].**
Parental Pass screen appears.
- 2 **Enter the parental code and touch [Enter].**
Parental Level screen appears.

NOTE

- The parental code is set to "0000" as default.
- To cancel the setup and return to the previous screen, touch [Cancel].
- To clear the entered code, touch [Clear].
- Current parental level appears as [Level#].

- 3 **Touch [◀] or [▶] to select a parental level.**



NOTE

- If a disc has higher parental lock level, you need to enter the code number.
- The parental lock level varies depending on a loaded disc.
- If a disc has no parental lock, anybody can play it back even when you have set the parental lock.

Disc setup

Performs setup when using disc media.

- 1 **Touch [SET] of [DISC SETUP].**
DISC SETUP screen appears.
- 2 **Select an option as follows.**

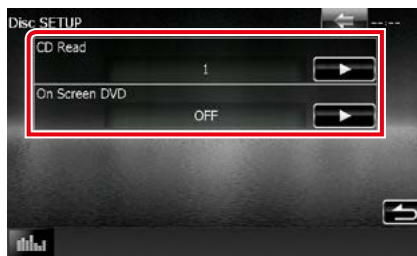

CD Read

Sets the motion of this unit when a music CD is played.

- 1 **(Default):** Automatically recognizes and plays back an audio file disc, a DVD or a music CD.
- 2: Forcibly plays back a disc as a music CD.
Select [2] if you wish to play a music CD having a special format or if you cannot play a disc in [1] position.

On Screen DVD

Sets an on-screen display.

Auto: When updated, information appears for 5 seconds.

OFF (Default): Information does not appear.

NOTE

- [CD Read] is not available when a disc is in the unit.
- You cannot play an audio file/VCD disc in the [2] position. Also, you may not play some music CDs in the [2] position.

CD/Audio and Visual Files/iPod/App Operation

Music/Video/Picture Basic Operation

Most functions can be controlled from the source control screen and playback screen.

NOTE

- Set the remote controller mode switch to AUD mode before starting operation, see [Switching the operation mode \(P.99\)](#).
- To connect the Android device with this unit, the cable (sold separately) and the profile which your Android device supports are necessary as follows:
 - To listen to music and watch video of APPS source
 - MHL device
 - KCA-MH100
 - Bluetooth profile: SPP
 - To listen to music of APPS source
 - Bluetooth profile: A2DP
 - Bluetooth profile: SPP
 - To listen to music of Bluetooth Audio source
 - Bluetooth profile: A2DP
 - Bluetooth profile: AVRCP
- To connect the iPod/iPhone with this unit, the cable, adapter (both sold separately), and the profile which your iPod/iPhone supports are necessary as follows:
 - To listen music and watch video with Lightning connector device
 - Lightning Digital AV Adapter
 - KCA-HD100
 - KCA-iP103
 - Bluetooth profile: SPP
 - To listen music with Lightning connector device
 - KCA-iP103
 - To listen music and watch video with 30-pin connector device
 - KCA-iP202
 - To listen music with 30-pin connector device
 - KCA-iP102
 - To listen to music via Bluetooth
 - Bluetooth profile: A2DP
 - Bluetooth profile: SPP

When connecting with Lightning Digital AV Adapter some applications can be controlled from this unit. The operable functions depend on the application.

- Do not leave the cable or the adapter made by other makers inside the car. It might lead the malfunction caused by heat.
- Some settings are necessary to meet the connected iPod/iPhone or Android device. Refer to [iPod/iPhone connection setup \(P.46\)](#) and [Application link setup \(P.48\)](#)

See the following sections for each source operation.

- **Music CD** [\(P.29\)](#)
- **Disc media** [\(P.29\)](#)
- **USB device** [\(P.31\)](#)
- **iPod** [\(P.31\)](#)
- **Pandora** [\(P.38\)](#)
- **AUPEO!** [\(P.41\)](#)
- **Apps** [\(P.43\)](#)

Music CD and disc media

NOTE

- In this manual, "Music CD" will be referred to as the general CDs which include music tracks in. "Disc media" will be referred to as CD/DVD disc which includes audio, picture or video files.
- The screen shot below is for CD. It may be different from the one for disc media.

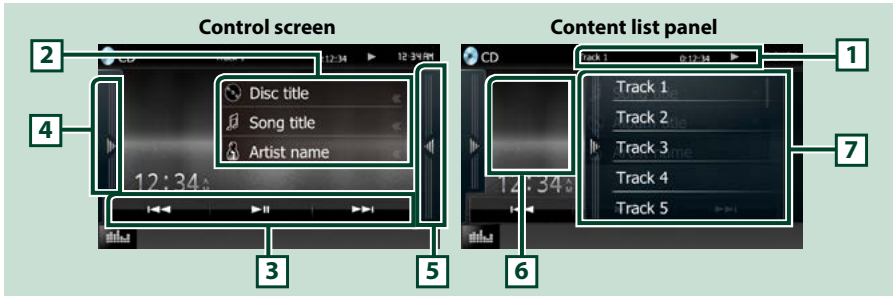

1 Information display

Displays the following information.

- **Track #:** Each time you touch this area, display switches between current track number, text, etc.
- **▶, ▶▶, ▶▶▶, ■, etc.:** Current play mode display
The meanings of each icon are as follows; ▶ (play), ▶▶ (fast forward), ◀◀ (fast backward), ▶▶| (search up), |◀◀ (search down), ■ (stop), **R** (resume stop), || (pause).

2 Track information

Displays the information of the current track.

However, only "No Information" is displayed for music CD.

3 Function bar

Various functions can be performed by using keys in this area. For details on the menu, see [Function bar \(P.32\)](#).

4 Function panel

Touch on the left side of the screen to display the function panel. Touch again to close the panel. For details on the keys, see [Function panel \(P.33\)](#).

5 Content list

Touching on the screen or flicking the screen to left will display the Content list. Touching again or flicking to right will close the list.

6 Artwork

The jacket of the currently playing file is displayed. Nothing is displayed if there is no jacket data.

7 Content list panel

Displays the playing list. When you touch a track/file name on the list, playback will start.

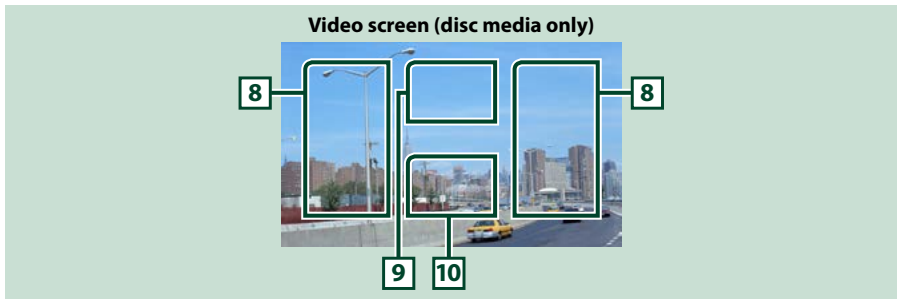

8 Searching file area (disc media only)

Touch to search the next/previous file.

Scrolling from center of display to left or right performs fast backward or fast forward. Each time you touch each area, the speed changes; standard, 2 times, 3 times. To stop fast backward/forward, touch center of the display.

9 Menu display area (disc media only)

Touch to display the disc menu. For details, see [Movie Control \(P.37\)](#).

10 Key display area (disc media only)

Touch to display the control screen.

USB device and iPod

NOTE

- The screen shot below is for USB device. It may be different from the one for iPod.

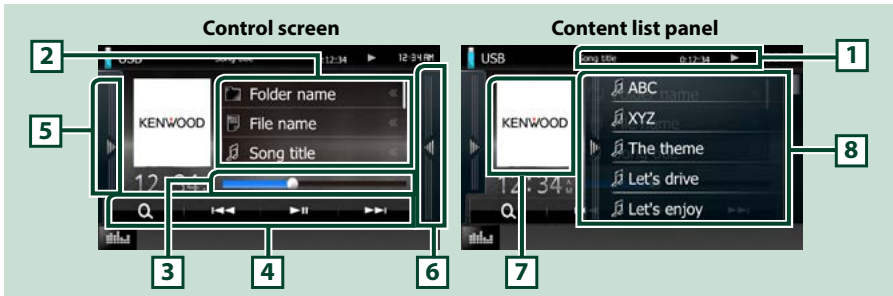

1 Information display

Displays the following information.

- **Current file name:** Each time you touch this area, display switches between file number/folder number and file name.
- **▶, etc.:** Current play mode display
The meanings of each icon are as follows; ▶ (play, searching), || (pause).

2 Track information

Displays the information of the current file.

3 Status bar

For confirmation of current playing position. You can drag the circle left or right to change the playing position.

4 Function bar

Various functions can be performed by using keys in this area. For details on the keys, see [Function bar \(P.32\)](#).

5 Function panel

Touch on the left side of the screen to display the function panel. Touch again to close the panel. For details on the keys, see [Function panel \(P.33\)](#).

6 Content list

Touching on the screen or flicking the screen to left will display the Content list. Touching again or flicking to right will close the list.

When you select the video source on the device connected with the Lightning connector, the source is switched to Apps [\(P.43\)](#) automatically.

7 Artwork

The jacket of the currently playing file is displayed. Nothing is displayed if there is no jacket data.

8 Content list panel

Displays the playing list. When you touch a track/file name on the list, playback will start.

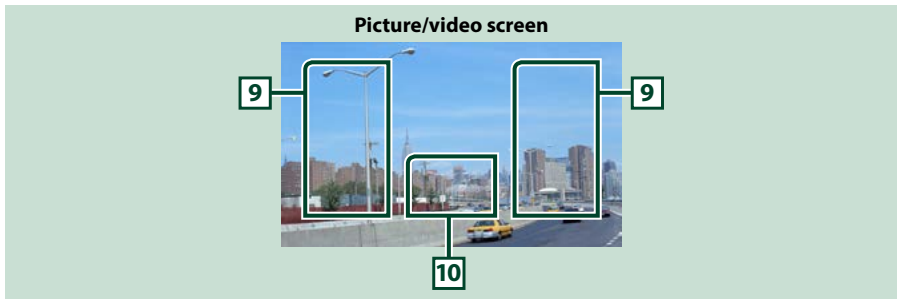

9 Searching file area (picture/video file only)

- Touch to search the next/previous file.
- During slide show in USB mode, touching each area searches the next/previous music file.
- Scrolling from center of display to left or right performs fast backward or fast forward. To stop fast backward/forward, touch center of the display. This function is not available when there is no music file in the current folder.

10 Key display area (picture/video file only)

Touch to display the control screen.

Function bar

Music CD



Disc media



iPod



USB device and SD card



The following functions can be performed by using keys in this area.

[] (Disc media, iPod, USB device, and SD card only)

Searches track/file. For details on search operation, see [Search Operation \(P.34\)](#).

[] []

Searches the previous/next track/file.

[]

Plays or pauses.

Function panel

1 Touch on the left side of the screen.

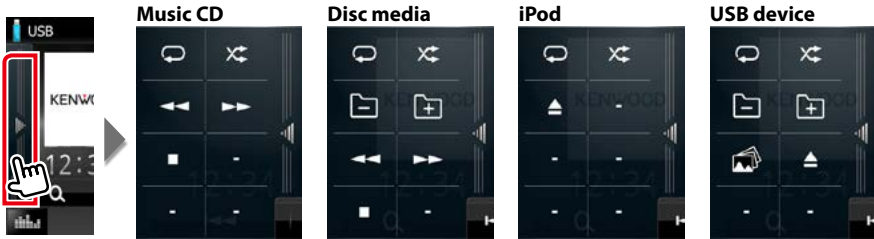

The following functions can be performed by using keys in this area.



Repeats the current track/folder. Each time you touch the key, repeat mode switches in the following sequence;

CD: "track repeat" "repeat off"

iPod: "song repeat" "all songs repeat" "repeat off"

Disc media, USB device: "file repeat" "folder repeat" "repeat off"



Randomly plays all tracks in current folder/disc or in current playlist in the connected iPod.

Each time you touch the key, random mode switches in the following sequence;

CD: "track random" "random off"

Disc media, USB device: "file random" "random off"

iPod: "track random" "album random" "random off"



Fast forward or fast backward.



Searches previous/next folder.

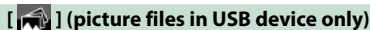

During picture playback, switches to picture display.

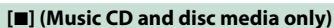

Stops playback.



Touch to disconnect the device. For details, see [How to Play Media \(P.10\)](#).

Search Operation

You can search music, video or picture files by the following operations.

NOTE

- If you use a remote control, you can jump directly to the desired track/file with entering the track/folder/file number, play time, etc. For details, see [Direct search mode \(P.99\)](#).

List search

You can search tracks, folders, and files according to hierarchy.

1 Touch on the right side of the screen.



Control list appears.

2 Touch desired track/file.

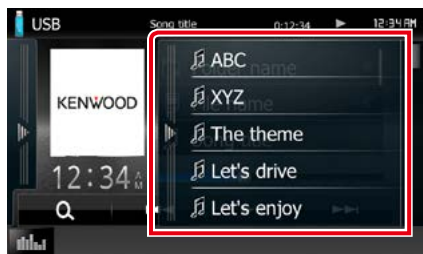

Playback starts.

NOTE

- For disc media, you can switch the file list and folder list by touching [].
- For disc media, you cannot display the list during random play and stop.

Other search

When you want to narrow the list down, there are other search ways.

This function is not available when music CD is the current source.

1 Touch [].

The search type screen appears.

2 Touch desired search way.

USB device



iPod

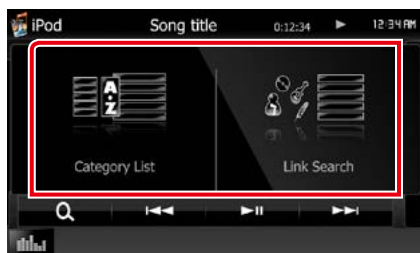

The list sorted in the way you selected appears.



See the following sections for each operation.

- [Category List]: You can search a file by selecting category ([P.35](#)).
- [Link Search]: You can search a file of same artist/album/genre/composer as the current track ([P.35](#)).
- [Folder List]: You can search a file according to hierarchy ([P.36](#)).
- [Thumbnail Viewer]: You can search a picture file ([P.36](#)).

NOTE

- For disc media, you can display the folder list directly by touching [].

Category search (USB device and iPod only)

- 1 Select whether you search by audio files  or video files .
- 2 Touch the desired category from the left part of the screen.



- 3 The list is sorted by selected category.
- 4 Touch desired item. Playback starts.

NOTE

- To narrow the search you can select a letter from the alphabet list in the center of the display.
- For operations in the list screen, see [Common Operations \(P.14\)](#).

Link search (USB device and iPod only)

- 1 Touch the desired item from the left part of the screen. You can select from artist, album, genre and composer.



The list corresponding to your selection appears.

NOTE

- The list is sorted by the way you selected.
- **artist:** Displays the album list of the artist.
- **album:** Displays all tunes of the current album.
- **genre:** Displays the artists list in which artists belong to the same genre.
- **composer:** Displays the album list of the composer of the current file.

- 2 Touch to select desired item in the list. Repeat this step until you find the desired file.

NOTE

- To narrow the search you can select a letter from the alphabet list in the center of the display.
- For operations in the list screen, see [Common Operations \(P.14\)](#).

Folder search (USB device and disc media only)

1 Touch the desired folder.



Folders in the selected source are displayed in the center.

When you touch a folder its contents are displayed.

The hierarchy till the current folder is displayed on the left.

2 Touch desired item from the content list.

Playback starts.

NOTE

- For operations in the list screen, see [Common Operations \(P.14\)](#).

Picture search (USB device only)

1 Touch the desired picture.

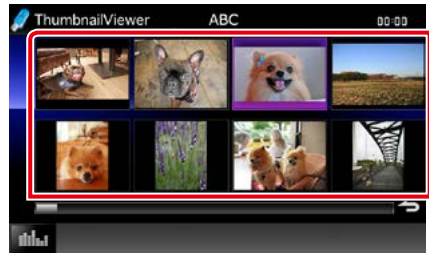

The selected picture appears in full screen. See number 9-10 in [USB device and iPod \(P.31\)](#) for operation of picture screen.

Movie Control

You can adjust the movie playback from a disc media.

- 1 In the playback screen, touch illustrated area.**



Movie Control screen appears.

- 2 Perform desired operation as follows.**



Changes subtitle language

Touch [Subtitle].

Changes audio language

Touch [Audio].

Exits the menu

Touch [Exit].

Pandora® Operation (region code 4 area only)

You can listen to the Pandora® on this unit by controlling the application installed in the iPhone or Bluetooth device.

To enter Pandora mode, touch [Pandora] icon in the HOME screen.

NOTE

- Install the latest version of the Pandora® application on your iPhone, Android or BlackBerry.
iPhone: Search for "Pandora" in the Apple App Store to find and install the most current version.
Android: Visit the Google play and search for Pandora to install.
BlackBerry: Visit www.pandora.com from the built in browser to download the Pandora application.
- When you first select Pandora as a source, the setting screen for the connection with the device installed the apps will appear. For the details, refer to [Application link setup \(P.48\)](#).

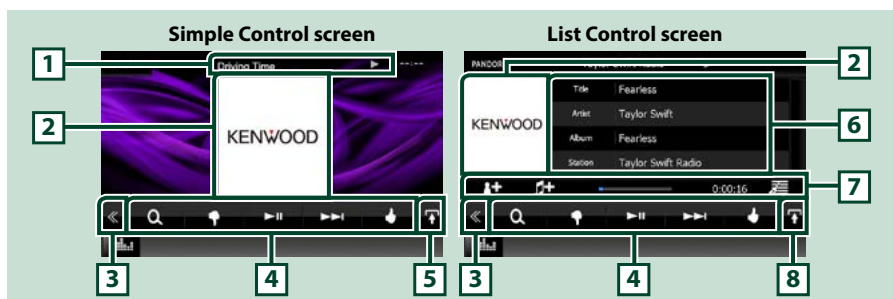

1 Information display

Displays text information of current contents that is being played.

2 Artwork/Control switching area

The picture data is displayed if available from current content.
Touch to switch between the Simple Control and List Control screen.

3 Multi function key

Touch to switch the multi function menu. For details on the menu, see [Multi function menu \(P.39\)](#).

4 Multi function menu

Various functions can be performed by using the keys in this area. For details on the keys, see [Multi function menu \(P.39\)](#).

5 Sub function key

Touch to display "Sub function menu" (7 in this table).

6 Content information

Displays the information of the current content being played.

7 Sub function menu

Various functions can be performed by using keys in this area. For details on the keys, see [Sub function menu \(P.39\)](#).

8 List switching key

Touch to switch between the content list and the current content information.

Multi function menu



The following functions can be performed by using keys in this area.



Searches for a station. For details on searching, see [Station list screen \(P.40\)](#).



Thumbs down to the current song and skip to the next song.



Plays or pauses the content of the current station.



Skips the current song.
(Note this function is disabled when the Pandora skip limitation is exceeded.)



Registers the current contents as favorite content.



Bookmark an artist in the current contents.



Bookmark a song in the current contents.

NOTE

- [SETUP], [AUDIO], and [REAR] functions same as iPod.

Sub function menu



The following functions can be performed by using keys in this area.

Status bar in center

Displays the elapsed time since when you select the station and status bar which shows current location.



Creates a new station based on an artist being played.



Creates a new station based on a song being played.



Displays the genre list screen. For details on searching, see [Genre list screen \(P.40\)](#).

Station list screen

You can perform the following functions from this screen.

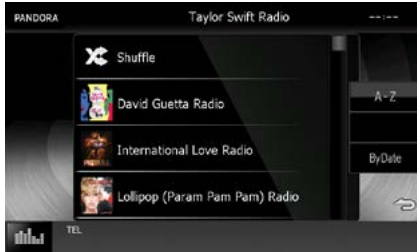

Selects the station

Touch the station name in the list.

Sort the list in alphabetical order

You can select the desired letter from the list which corresponds to the station name to help narrow the search.

Sort the list by registered date

Touch [ByDate]. The list is sorted to begin with the last registered station.

NOTE

- You can operate Pandora by using the remote control. However, only playing, pausing, and skipping are available.
- You cannot select iPod as rear source when you select Pandora as main source in dual zone function.

Genre list screen

You can perform the following functions from this screen.



The selected genre is created as a new station.

AUPEO! Operation

You can listen to the AUPEO! on this unit by controlling the application installed in the iPhone or Android.

To enter AUPEO! mode, touch [AUPEO!] icon in the HOME screen.

NOTE

- Install the latest version of the AUPEO! application "AUPEO!" on your iPhone or Android.
iPhone: Search for "AUPEO!" in the Apple App Store to find and install the most current version.
Android: Search for "AUPEO!" in Google play to find and install the most current version.
- When you first select AUPEO! as a source, the setting screen for the connection with the device installed the apps will appear. For the details, refer to [Application link setup \(P.48\)](#).

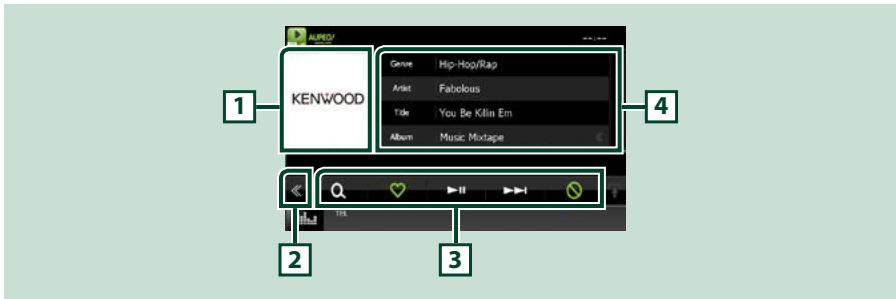

1 Artwork switching area

The picture data is displayed if available from current content. When the picture is not available, "No Photo" is displayed.

2 Multi function key

Touch to switch the multi function menu. For details on the menu, see [Multi function menu \(P.42\)](#).

3 Multi function menu

Various functions can be performed by using the keys in this area. For details on the keys, see [Multi function menu \(P.42\)](#).

4 Content information

Displays the information of the current content being played.

Multi function menu



The following functions can be performed by using keys in this area.



Searches for a station. For details on searching, see [Station search \(P.42\)](#).



Touching the key "Love" current song.



Plays or pauses.



Skips the current song.



Touching the key "Ban" current song.

NOTE

- [SETUP], [AUDIO], and [REAR] functions same as iPod.

Station search

You can list and select station.

1 Touch [] in the control screen.

The Station Search screen appears.

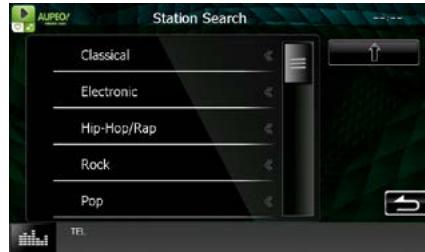

Selects the category and station

Touch the category and station name in the list.



Returns to the previous category list.

Apps Operation

You can listen to music or watch video from the Apps operating on iPod touch/iPhone or Android. To enter Apps mode, touch [APPS] icon in the HOME screen.

NOTE

- When you turn on the power and select apps as the source, the caution for the operation, watching video and listening music appears. With your acceptance, you can control apps, listen to music and watch video from apps when you are driving.
- When you first select APPS as a source, the setting screen for the connection with the device installed the apps will appear. For the details, refer to [Application link setup \(P.48\)](#).
- If the conditions below are satisfied, the touch keys will not appear, but the touch operation from the screen of the unit to the Android device becomes possible.
 - The unit and the Android device are connected with KCA-MH100 (sold separately) and over Bluetooth profile HID and SPP.
 - “Kenwood Smartphone Control” is installed on the Android device. For details, see web site. http://www.kenwood.com/products/car_audio/app/kenwood_smartphone_control/eng/index.html
 - If you drive using an app that is prohibited from using while driving, the confirmation screen appears. As you select [Yes], the launcher of “Kenwood Smartphone Control” starts.
- Depending on the app, the touch keys may not work or be displayed.



When the touch keys appear



When the touch operation is possible



1 Multi function key (iPod touch/iPhone only)

Touch to switch the multi function menu.

2 Multi function menu (iPod touch/iPhone only)

The following functions can be performed by using keys in this area.

- Plays or pauses: Touch [▶], [⏸], or [▶⏸] (iPod only).
- Searches the previous/next track/file: Touch [◀◀] or [▶▶].

3 Sub function menu (iPod touch/iPhone only)

The following functions can be performed by using keys in this area.

- Hides all keys (During video file playback only): Touch [⏏]

USB/iPod/DivX Setup

You can perform setup when using USB/iPod/DivX.

NOTE

- Each operation in this section can be started from the HOME screen. For details, see [Operating with the HOME Screen \(P.32\)](#).
- Some setup items can only be set in standby mode.

1 Press the volume knob.

Pop-up menu appears.

2 Touch [SETUP].

SETUP Menu screen appears.

3 Touch [Source].

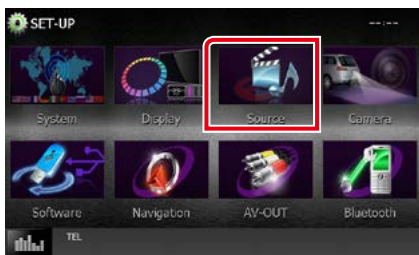

Source SETUP Menu screen appears.

4 Touch [USB SETUP], [iPod SETUP], [APP SETUP], or [DivX(R) VOD] in the list.

Each setup screen appears.

See the following section for each setting.

- [USB setup \(P.44\)](#)
- [iPod setup \(P.46\)](#)
- [Application link setup \(P.48\)](#)
- [DivX\(R\) VOD \(P.45\)](#)

USB setup

1 Set each item as follows.



Picture Display Time

Selects length of time to display JPEG picture file in the screen. Select from [Short], [Middle], and [Long] (default).

On Screen USB

Sets how to display the information of the USB device.

Auto (Default): Information appears for 5 seconds when updated.

OFF: Does not display any information.

DivX(R) VOD

1 Set each item as follows.



DivX(R) Registration Code

Checks the registration code. This code is needed when making a disc which has DRM (Digital Rights Management).

DivX(R) Deactivation

Deregisters the unit which is already registered. After you touch the key, a confirmation message appears. Follow the message and complete the operation.

NOTE

- [DivX(R) VOD] is disabled when a disc is being played.
- When downloading a DivX VOD file controlled by DRM, register the code appeared on the screen. Otherwise the file may not be able to play with this unit. Remaining number of viewing is displayed when playing a DivX VOD file with the viewing restriction. When the used number of viewing reached maximum number, a warning message appears and the file cannot be played.

iPod setup

1 Set each item as follows.

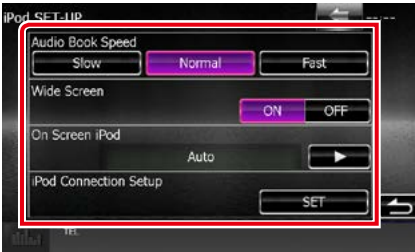

AudioBook Speed

Sets the audio book playback speed. Select from [Slow], [Normal] (default), and [Fast].

Wide Screen*

Sets Wide Screen. Set [ON] (default) or [OFF].

On Screen iPod

Sets how to display the information of the iPod.

Auto (Default): Information appears for 5 seconds when updated.

OFF: Does not display any information.

iPod connection setup

Sets the way to connect the iPod/iPhone with this unit. For details on searching, see [iPod/iPhone connection setup \(P.46\)](#).

* This setting is not available when an iPod is connected.

iPod/iPhone connection setup

- 1 Press the <HOME> button.
HOME screen appears.
- 2 Touch [STANDBY].
- 3 Press the volume knob.
Popup menu appears.
- 4 Touch [SETUP].
SETUP Menu screen appears.
- 5 Touch [Source].
Source SETUP Menu screen appears.
- 6 Touch [iPod SETUP] in the list.
- 7 Touch [iPod Connection Setup] in the iPod Settings screen.
iPod connection setup screen appears.
- 8 Touch [CHANGE].



9 Select the way to connect the iPod/iPhone with this unit.



USB + AV-IN

Select when connecting with KCA-iP202.

USB 1Wire

Select when connecting with KCA-iP103 or KCA-iP102.

HDMI + BT

Select when connecting with KCA-HD100 and Lightning Digital AV Adapter.

Bluetooth

Select when connecting via Bluetooth only.

10 Touch [Next].

Confirmation screen appears.

11 Touch [Done].

NOTE

- For the details of the necessary cable and adapter to connect with iPod/iPhone, refer to [Music/Video/Picture Basic Operation \(P.28\)](#).
- When you select "HDMI + BT" or "Bluetooth" in step 9, Bluetooth device selection screen will appear. Select the iPod/iPhone to be connected.



If a connectable Bluetooth device is not displayed, touch [Search] and do the pairing of the devices.

Application link setup

Sets the device an application is installed in and the app is selected as the source.

- 1 Press the <HOME> button.**
HOME screen appears.
- 2 Touch [STANDBY].**
- 3 Press the volume knob.**
Popup menu appears.
- 4 Touch [SETUP].**
SETUP Menu screen appears.
- 5 Touch [Source].**
Source SETUP Menu screen appears.
- 6 Touch [APP SETUP] in the list.**
- 7 Touch [CHANGE].**



8 Select the device installed the apps.



iPod / iPhone

Select when using iPod/iPhone.

Android / Other

Select when using Android or BlackBerry device.

- 9 Touch [Next].**
Connection setup screen appears.

10 Select the way to connect the device with this unit.



When selecting [iPod / iPhone]

USB + AV-IN

Select when connecting with KCA-IP202.

USB 1Wire

Select when connecting with KCA-IP103 or KCA-IP102.

HDMI + BT

Select when connecting with KCA-HD100 and Lightning Digital AV Adapter.

Bluetooth

Select when connecting via Bluetooth only.

When selecting [Android / Other]

HDMI/MHL + BT

Select when connecting with KCA-MH100.

Bluetooth

Select when connecting via Bluetooth only.

- 11 Touch [Next].**
Confirmation screen appears.

- 12 Touch [Done].**

NOTE

- This setup can be set when in STANDBY source.
- To enable the touch operation on this unit, install "Kenwood Smartphone Control" and start it. Search for "Kenwood Smartphone Control" in Google play to find and install the most current version.
- When you select APPS source and APP Settings appears, touch [OK] after setting. The screen will return to APP after you agree the caution.



- For the details of the necessary cable and adapter to connect with iPod/iPhone and Android, refer to [Music/Video/Picture Basic Operation \(P.28\)](#).
- When you select "HDMI + BT", "HDMI/MHL + BT" or "Bluetooth" in step 10, Bluetooth device selection screen will appear. Select the device to be connected.



If a connectable Bluetooth device is not displayed, touch [Search] and do the pairing of the devices.

- When you select "iPod/ iPhone" in Apps Setup, select "iPod" as the source, and select App on the iPod, the source of this unit is also changed to App automatically.

Radio Operation

Radio Basic Operation

Most functions can be controlled from the source control screen.

NOTE

- Set the remote controller mode switch to AUD mode before starting operation, see [Switching the operation mode \(P.99\)](#).

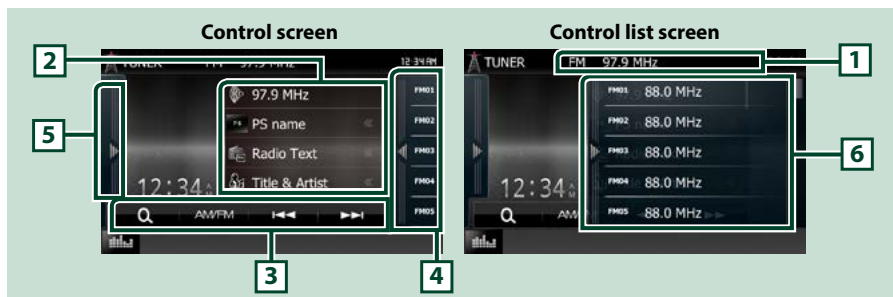

1 PS/Station name display (FM Tuner only)

Displays the PS name, Station name or Band, Frequency, Preset number.

2 Information display

Displays information about the current station: Frequency, PS name, Radio Text, Song Title, Artist Name, etc.

3 Function bar

Various functions can be performed by using keys in this area. For details on the menu, see [Function bar \(P.51\)](#).

4 Preset key

Recalls the memorized station or channel.

Touching on the screen or flicking the screen to left will display the Preset list. Touching again or flicking to right will close the list.

5 Function panel

Touch on the left side of the screen to display the function panel. Touch again to close the panel. For details on the keys, see [Function panel \(P.51\)](#).

6 Preset list

Recalls the memorized station or channel. When touched for 2 seconds, stores the current receiving station or channel in memory.

Function bar



The functions of each key are as follows.

[AM/FM]

Switches the band.

[◀▶]

Tunes in a station. The method of frequency switching can be changed. See [Function panel \(P.51\)](#).

[CH▼] [CH▲] (HD Radio tuner only)

Selects a channel.

[Q]

Selects the method of searching from preset stations selecting or channel searching. For details on search operation, see [Selecting Operation \(P.55\)](#).

Function panel

1 Touch on the left side of the screen.



The functions of each key are as follows.

[TI] (FM Tuner only)

Sets the traffic information mode on. For details, see [Traffic Information \(P.56\)](#).

[SEEK]

Switches the seek mode in the following sequence; [AUTO1], [AUTO2], [MANUAL].

- AUTO1: Tunes in a station with good reception automatically.
- AUTO2: Tunes in stations in memory one after another.
- MANUAL: Switches to the next frequency manually.

[AME]

Selects the auto memory mode. For details, see [Auto memory \(P.54\)](#).

[PTY] (FM Tuner only)

Searches a program by setting program type. For details, see [Search by program type \(P.56\)](#).

[MONO] (FM Tuner only)

Select the Monaural reception.

[LO.S] (FM Tuner only)

Turns the Local Seek function on or off.

Digital Radio Basic Operation (DNX4150DAB only)

Most functions can be controlled from the source control screen.

NOTE

- Set the remote controller mode switch to AUD mode before starting operation, see [Switching the operation mode \(P.99\)](#).

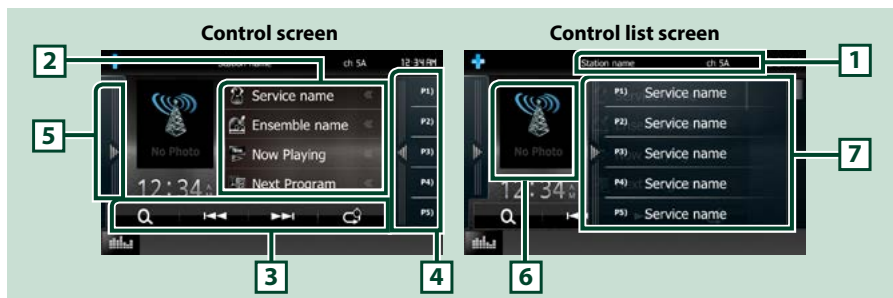

1 Service name display

Displays the Service name.

2 Information list

Displays information about the current music being played: Channel Name, Artist Name, Song Title, Content Info, Category Name, Channel Description, Similar Channels

3 Function bar

Various functions can be performed by using keys in this area. For details on the menu, see [Function bar \(P.53\)](#).

4 Preset key

Recalls the memorized service.

Touching on the screen or flicking the screen to left will display the Preset list. Touching again or flicking to right will close the list.

5 Function panel

Touch on the left side of the screen to display the function panel. Touch again to close the panel. For details on the keys, see [Function panel \(P.53\)](#).

6 Artwork area

The picture data is displayed if available from current content.

7 Preset list

Recalls the memorized service. When touched for 2 seconds, stores the current service in memory.

Function bar



The functions of each key are as follows.



Tunes in a ensemble, service, and component. The seek mode switching can be changed. See [Function panel \(P.53\)](#).



Selects the method of searching from preset stations selecting or channel searching. For details on search operation, see [Selecting Operation \(P.55\)](#).



Change the Replay mode. See [Replay \(P.57\)](#).

Function panel

1 Touch on the left side of the screen.

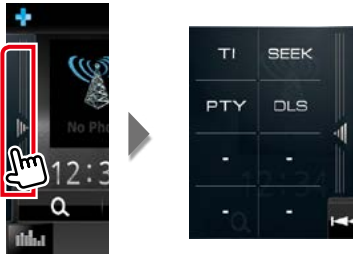

The functions of each key are as follows.



Sets the traffic information mode on. For details, see [Traffic Information \(P.56\)](#).



Switches the seek mode in the following sequence; [AUTO1], [AUTO2], [MANUAL].

- AUTO1: Tunes in a ensemble with good reception automatically.
- AUTO2: Tunes in ensemble in memory one after another.
- MANUAL: Switches to the next ensemble manually.



Searches a program by setting program type. For details, see [Search by program type \(P.56\)](#).



Display the Dynamic Label Segment screen.

Memory Operation

Auto memory

You can store stations with good reception in memory automatically.

This function is for radio only.

NOTE

- Auto memory terminates when 6 stations are stored or when all stations are tuned in.
- The operation ends automatically if you do not operate within 10 seconds.

1 Touch desired band key.



2 Touch on the left side of the screen. Touch [AME].

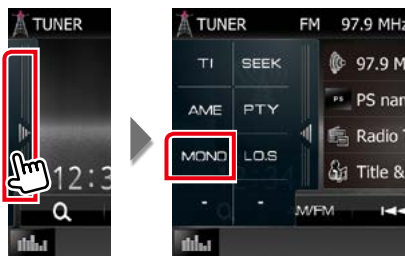

3 Touch [◀◀] or [▶▶] in the sub function menu.

Auto memory starts.

Manual memory

You can store the current receiving station or channel in memory.

- 1 Select a station or channel you wish to store in memory.**
- 2 Touch [FM#] (#:1-15), [AM#] (#:1-5), or [P#] (#:1-15) in which you want to store the station or channel for 2 seconds until a beep sounds.**

Selecting Operation

Preset select

You can list and select memorized station, ensemble, or channel.

Selecting from the preset list

1 Touch on the right side of the screen.



List Control screen appears.

2 Select a station or channel from the list.



NOTE

- Touching [] and then [Preset List] displays the preset channel list. You can also select your desired channel from the list.

List select

You can select an ensemble from a list of memorized ensembles or select a service from a list of all services received.

1 Touch [] in the Function bar.



The list type screen appears.

2 Touch desired list way.

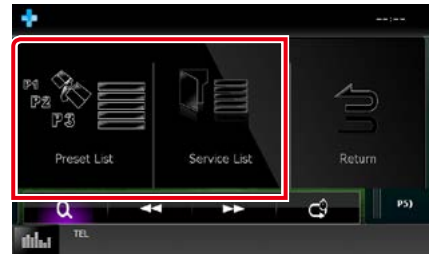

List screen appears.

3 Select a service from the list.

Search by program type (FM tuner and Digital Radio only)

You can tune to a station with a specific program type when listening to FM/ Digital Radio.

- 1 Touch on the left side of the screen.
Touch [PTY].



PTY Mode screen appears.

- 2 Select a program type from the list.
- 3 Touch [Search].

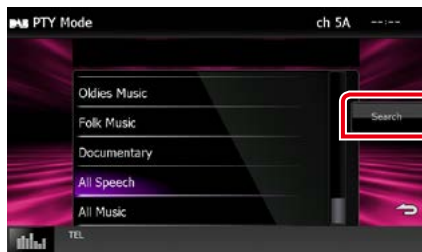

You can search a station of the selected program type.

Traffic Information (FM tuner and Digital Radio only)

You can listen and watch the traffic information automatically when a traffic bulletin starts.

However, this feature requires a Radio Data System and Digital Radio that includes the TI information.

- 1 Touch on the left side of the screen.
Touch [TI].

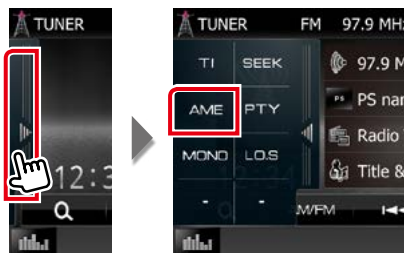

Traffic information mode is set.

When the traffic bulletin starts

The Traffic Information screen appears automatically.



NOTE

- It is necessary to have Traffic Information function set to on in order to have the Traffic Information screen appear automatically.
- The volume setting during reception of traffic information is automatically stored. The next time the traffic information is received, this unit recalls the volume setting automatically.

Replay (Digital Radio only)

You can replay last 15 minutes of current station.

1 Touch [] in the Function bar.

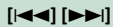

Forward/backward 15 seconds when touch it.



Plays or pauses.



Fast forward/fast backward when keep on touching.

Replay time bar

Display recorded capacity



Change the Live mode



Touch to display "Sub function menu".

NOTE

- PTY Watch starts operating and Replay function cannot be used while receiving a program.
- While replaying the current station, you can not store the station by [Manual memory \(P.54\)](#)

Tuner Setup

You can set tuner related parameters.

1 Press the volume knob.

Popup menu appears.

2 Touch [SETUP].

SETUP Menu screen appears.

3 Touch [Source].

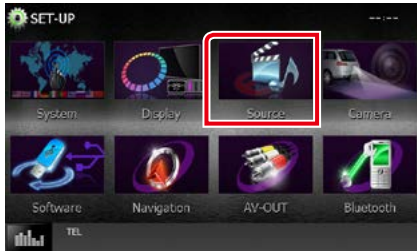

Source SETUP Menu screen appears.

4 Touch [TUNER SETUP] in the list.

TUNER SETUP screen appears.

5 Set each item as follows.



NEWS

Sets a news bulletin interrupt time. Default is "OFF".

AF

When station reception is poor, automatically switches to the station that is broadcasting the same program over the same Radio Data System network. Default is "OFF".

Regional

Sets whether to switch to the station only in the specific region using the "AF" control.

Default is "OFF".

Auto TP Seek

When traffic information station reception is poor, automatically searches for a station that can be received better. Default is "ON".

Language Select

Selects a display language for the PTY function.

Antenna Control

Allows you to turn off the Radio Data System function to prevent the motor-driven antenna from extending. Default is "ON".

Digital Radio Setup

You can set Digital Radio related parameters.

1 Press the volume knob.

Popup menu appears.

2 Touch [SETUP].

SETUP Menu screen appears.

3 Touch [Source].

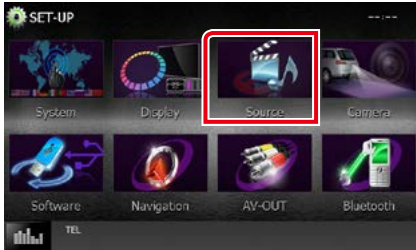

Source SETUP Menu screen appears.

4 Touch [Digital Radio SETUP] in the list.

Digital Radio SETUP screen appears.

5 Set each item as follows.



Priority

If the same service is provided by Digital Radio during Radio Data System reception, automatically switches to Digital Radio. If the same service is provided by Radio Data System when reception of the service being provided by Digital Radio becomes poor, automatically switches to Radio Data System.

PTY Watch

If the service of the set program type begins with the ensemble being received, switches from any source to Digital Radio for service reception.

Announcement Select

Switches to the set Announcement service. For details, see [Announcement setup \(P.60\)](#).

Seamless Blend

Prevents audio break when switching from Digital Radio to Analog Radio. Default is "ON".

Antenna Power*

Sets power supply to the Digital Radio antenna. Set to "ON" when the Digital Radio antenna in use is equipped with a booster. Default is "ON".

L-Band Tuning*

Sets L-band reception. When set to "ON", also receives L-band ensembles.

* This item can be set when in STANDBY source.

Announcement setup

When the service for which ON is selected starts, switches from any source to Announcement to receive it.

1 Touch [SET] of [Announcement Select] in the Digital Radio SETUP screen.

The Announcement Select screen appears.

2 Touch each Announcement list and set on or off.



NOTE

- The volume setting during reception of Announcement service is automatically stored. The next time the Announcement service is received, this unit recalls the volume setting automatically.

Bluetooth Control

Using the Bluetooth function, various functions can be used: listening to the audio file, making/receiving a call.

About the cell-phone and Bluetooth audio player

This unit conforms to the following Bluetooth specifications:

Version

Bluetooth Ver. 3.0+EDR Certified

Profile

Cell-phone:

HFP (V1.6) (Hands Free Profile)

SPP (Serial Port Profile)

HID (Human Interface Device Profile)

PBAP (Phonebook Access Profile)

GAP (Generic Access Profile)

Audio player:

A2DP (Advanced Audio Distribution Profile)

AVRCP (V1.4) (Audio/Video Remote Control Profile)

Sound codec

SBC, AAC, MP3

NOTE

- For the cell-phones verified for compatibility, access the following URL:
<http://www.kenwood.com/cs/ce/bt/>
- The units supporting the Bluetooth function have been certified for conformity with the Bluetooth Standard following the procedure prescribed by Bluetooth SIG.
However, it may be impossible for such units to communicate with your cell-phone depending on its type.

Registering And Connecting Bluetooth Unit

It is necessary to register the Bluetooth audio player or cell-phone to this unit before using the Bluetooth function.

You can register up to 5 Bluetooth units.

1 Press the volume knob.

Pop-up menu appears.

2 Touch [SETUP].

SETUP Menu screen appears.

3 Touch [Bluetooth].

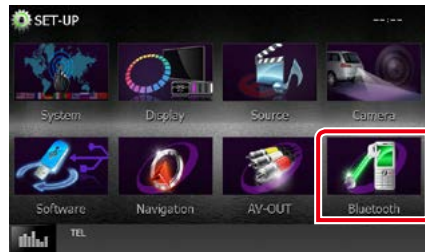

Bluetooth SETUP screen appears.

See the following section for each setting.

- **Registering the Bluetooth Unit** ([P.63](#))
- **Connecting the Bluetooth unit** ([P.64](#))
- **Registering from the Bluetooth unit** ([P.64](#))
- **Change the PIN code** ([P.65](#))

Registering the Bluetooth Unit

Preparation

- You cannot register the Bluetooth unit when you are using the following sources:
iPod, Bluetooth Audio, APPS, Pandora, AUPEO!
If you want to register the Bluetooth unit while using one of the above mentioned sources, send the connection request from the Bluetooth unit and register it.

1 Press the <HOME> button.

HOME screen appears.

2 Touch [STANDBY].

3 Press the volume knob.

Popup menu appears.

4 Touch [SETUP].

SETUP Menu screen appears.

5 Touch [Bluetooth].

Bluetooth SETUP screen appears.

6 Touch [Search].

Searched Device List screen appears.

NOTE

- A new device cannot be registered if there are 5 registered Bluetooth units. Delete unnecessary registration. See [Connecting the Bluetooth unit \(P.64\)](#).
- This unit is compatible with the Apple Easy Pairing function. When an iPod touch or iPhone is connected to this unit, an authentication dialog appears. Performing operation for authentication on this unit or iOS smartphone registers the smartphone as a Bluetooth device.
- If two Bluetooth units are connected, this unit will not start the search. In this case disconnect one of the Bluetooth units.

7 Select the Bluetooth unit to register from the list.



NOTE

- If the unit cannot be searched in step 1, you can search the unit again by touching [Search] in above screen.
- Touch [Cancel] to cancel searching for the Bluetooth unit.

8 Enter PIN code form the cell-phone.

Connecting the Bluetooth unit

- 1 Touch the device name you want to connect.

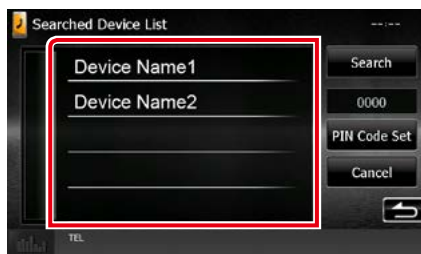

Profile select screen appears.

NOTE

- If the icon is lighted, it means that the unit will use that device.

- 2 Set each profile as follows.



TEL (HFP)

Means that the device is a cell-phone.

Audio (A2DP)

Means that the device is an audio player or cell-phone with audio player.

APP SETUP

Selects the device in which apps are installed and how to connect with the unit. Pressing [CHANGE], you will jump to the step 8 in page 48. See [Application link setup \(P.48\)](#).

NOTE

- If a device has been paired, the Bluetooth unit cannot be connected from the paired device.
- Touching [Remove] of [Device Remove Confirm] removes registration information. After you touch the key, a confirmation message appears. Follow the message and complete the operation.

Registering from the Bluetooth unit

- 1 Search the unit ("DNX****") from your smartphone/cell-phone.
- 2 Input the PIN code in your smartphone/cell-phone.
PIN code is set to "0000" as the default.

SSP (Secure Simple Pairing of Bluetooth 2.1 or later)

- 1 Search the unit ("DNX****") from your smartphone/cell-phone.
- 2 Confirm the request both on the smartphone/cell-phone and the unit.



Change the PIN code

1 Touch [PIN Code Set].



PIN Code Set screen appears.

2 Input the PIN code



3 Touch [Enter].

Playing Bluetooth Audio Device

Bluetooth basic operation

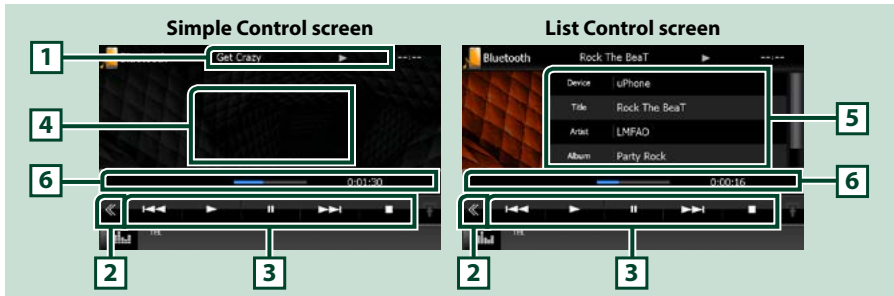

1 Information display

Displays the name of the track information. If the information is not available, device name is displayed.

2 Multi function key

Touch to switch the multi function menu.

3 Multi function menu

The functions of each key are as follows.

- [◀▶]: Searches the previous/next content.*
- [▶]: Plays.*
- [⏸]: Pauses.*
- [⏹]: Stops playback.*
- [🔊 AUDIO]: Touch to display the Audio Control screen. See [Registering the Bluetooth Unit \(P.63\)](#).
- [⚙️ SETUP]: Touch to display the SETUP Menu screen. See [Setting Up \(P.72\)](#).
- [🔇 REAR 🔇]: Touch to mute the rear speaker.

4 Control switching area

Touch to switch between the Simple Control and List Control screen.

5 File information

Displays the information of the current file.

6 Status bar

Displays the current play location, play time, and play mode.

* These items appear only when the audio player which supports AVRCP profile is connected.

NOTE

- If the operation keys do not appear, operate from the player.
- Depending on your cell-phone or audio player, audio may be heard and controlled but text information may not appear.
- If the volume is too low, raise it on your cell-phone or audio player.

Using Hands-Free Unit

You can use telephone function by connecting the Bluetooth telephone to this unit.

Making a call

1 Press the <TEL> button.

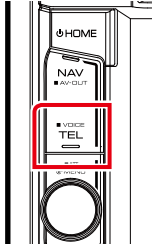

Hands Free screen appears.

NOTE

- When registration of your cell-phone is completed, the phone book of the cell-phone is automatically downloaded to this unit.
- Up to 600 phone numbers can be registered for each registered cell-phone.
- Up to 30 digits can be registered for each phone number along with up to 50 characters representing a name. (50 is the number of alphabetical characters. Fewer characters can be input depending on the type of characters.)
- Depending on the type of your cell-phone, the following restrictions are placed;
 - The phonebook data cannot be downloaded normally.
 - Characters in the phonebook are garbled.
- To cancel downloading the phonebook data, operate the cell-phone.

2 Select a dialing method.



See the following table for each method.



Select the cell-phone to use

When you connect two cell-phones





- ① Touch [] to select the phone you want to use.

If you register a cell-phone (device) for both hands-free call and APP Link, and you select that cell-phone (device) for hands-free call, it is also selected as the device of APP Link automatically. See [Application link setup \(P.48\)](#).



Call by entering a phone number

- ① Touch [].
- ② Enter a phone number with number keys.
- ③ Touch [].

Call using call records

- ① Touch [], [], or [].
- ② Select the phone number from the list.
- ③ Touch [].

Call using the phonebook

- ① Touch [].
- ② Select the name from the list.*1*2
- ③ Select the number from the list.
- ④ Touch [].

Call using the preset number

- ① Touch [Preset #] to start calling the corresponding phone number.
- ② Touch [].

Bluetooth SETUP

- ① Touch [].
Bluetooth SETUP screen appears.

Continued

*1 You can sort the list to begin with touched character.



- Characters with no corresponding name will not appear.
- During search, a non-accent character such as “u” is searched for instead of an accent character such as “ü”.

*2 You can set the list to arrange in the order of last name or first name. For details, see [Hands-Free Setup \(P.70\)](#).

NOTE

- If you edited the phonebook in your cell-phone, touch “Download” on top of the phonebook list in this unit to download it from your cell-phone. The phonebook in this unit will be updated with the latest downloaded data.
- While your car is moving, some functions are disabled for safety reasons. The keys associated with the disabled functions become ineffective if touched.
- The status icons such as battery and antenna displayed may differ from those displayed on the cell-phone.
- Setting the cell-phone in the private mode can disable the hands-free function.

Receiving a call

1 Touch [] to answer a phone call or [] to reject an incoming call.



NOTE

- While monitoring the camera view, this screen does not appear even if a call comes in. To display this screen, press the <TEL> button or return the shift knob of car to the driver position.

Operations during a call

Adjust the receiver volume

Turn the volume knob.

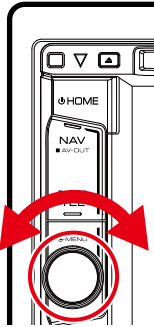

Output the dial tone

Touch [DTMF] to display the tone input screen. You can send tones by touching desired keys on the screen.

Switching the speaking voice output

Touching [Speaker icon] / [Cellphone icon] each time switches the speaking voice output between cell-phone and speaker.

Call-waiting

When you receive a call while talking on another call, you can answer the newly received call by touching [Call icon]. The current call is on hold.

Each time you touch [Call icon], the caller will change.

When you touch [End call icon], the current call will end and switch to the call in hold.

Phone number preset

You can register frequently used phone numbers to this unit.

1 Enter the number you want to register in Hands Free screen.



2 Touch [Preset 1], [Preset 2], or [Preset 3] for 2 seconds in the Hands Free screen.

Voice Recognition

You can access the voice recognition function of the cell-phone connected to this unit. You can search the cell-phone phonebook by voice. (The functionality depends on the cell-phone.)

1 Press the <TEL> button for 1 second.

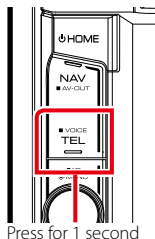

Voice Recognition screen appears.

2 Start speaking.

NOTE

- You can use voice recognition function by touching [] on the Hands Free screen.

Hands-Free Setup

You can perform various setup about handsfree function.

1 Press the volume knob.

Popup menu appears.

2 Touch [SETUP].

SETUP Menu screen appears.

3 Touch [Bluetooth].

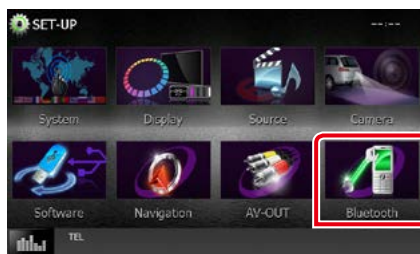

Bluetooth SETUP screen appears.

4 Touch [TEL SET-UP] in the Bluetooth SET-UP screen.



Hands-free SETUP screen appears.

5 Set each item as follows.



Bluetooth HF/Audio

Select the speakers to output the sound from cell-phone (such as phone call voice and ringing tone) and Bluetooth audio player.

Front Only: Outputs from the front speakers.

All (Default): Outputs from all speakers.

Auto Response*

Sets an automatic response time to pick-up an incoming call.

OFF (Default): Automatic response is not available.

0-99: Set calling ring time (second).

Auto Pairing

When set to "ON", the Apple Auto Pairing function is turned on to automatically register the iPod touch or iPhone connected to this unit.

ON (Default): Uses Apple Auto Pairing function.

OFF: Not uses Apple Auto Pairing function.

Phone Information Use

Sets whether to use phonebook, outgoing, incoming and missed calls list.

ON (Default): Yes.

OFF: No.

Sort Order

Sets how to arrange the cell-phone phonebook.

First: Arranges in the order of first name.

Last (Default): Arranges in the order of last name.

Echo Cancel Level

Adjusts the level of echo cancellation.

Default is "1".

Microphone Level

Adjusts the sensitivity of the telephone microphone. Default is "3".

Noise Reduction Level

Reduces the noises generated by surrounding environment without changing the microphone volume. Use this setting when the voice of caller is not clear. Default is "-10".

[Restore]

Resets the settings to the default settings.

*** Either the time interval for automatic answer set on this unit or the time interval set on the cell-phone, whichever is shorter takes effect.**

Setting Up

Monitor Screen Setup

You can adjust image quality in iPod video, picture file, menu screen, etc.

- 1 Press the volume knob.**
Popup menu appears.
 - 2 Touch [Screen Adjustment].**
Screen Control screen appears.
 - 3 Adjust each item as follows.**
- iPod/ AV-IN/ Camera

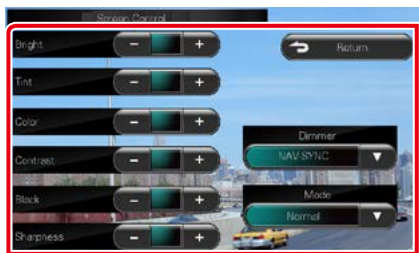

DVD/ USB



Bright / Tint* / Color* / Contrast / Black / Sharpness*

Adjusts each item.

Dimmer

Select dimmer mode.

ON: The display and buttons dim.

OFF: The display and buttons do not dim.

SYNC (Default): Turns the dimmer function on or off when the vehicle light control switch is turned on or off.

NAV-SYNC: Turns the dimmer function on or off according to the Navigation Day/Night display setting.

Mode* (except USB)

Select screen mode.

Full: Full picture mode

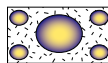

Just: Justify picture mode

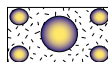

Zoom: Zoom picture mode

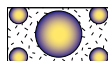

Normal: Normal picture mode

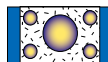

* Playback screen only

NOTE

- Adjusting items are different depending on the current source.
- You can perform this function only when you have applied the parking brake.
- The image quality can be set for each source.

System Setup

NOTE

- Each operation in this section can be started from the multi function menu.

1 Press the volume knob.

Popup menu appears.

2 Touch [SETUP].

SETUP Menu screen appears.

3 Touch [System].

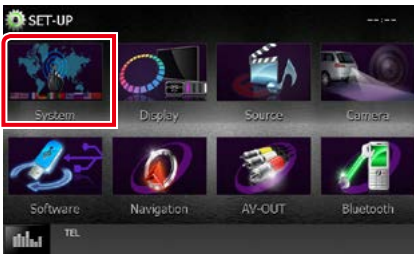

System Menu screen appears.

See the following section for each setting.

- **Set up the user interface** ([P.74](#))
- **Adjust touch panel** ([P.76](#))
- **Set up security** ([P.77](#))
- **Set up memory** ([P.78](#))

User interface

You can setup user interface parameters.

1 Touch [User Interface] in the list.

User Interface screen appears.

2 Set each item as follows.



Beep

Turns the key touch tone on or off.
Default is "ON".

Language

Select the language used for the control screen and setting items. See [Language setup \(P.75\)](#).

Text Scroll

Allows scrolling of text display on the source control screen. Select from "Auto"/"Once"/"OFF".

Auto (Default): Scrolls the text automatically.

Once: Allows you to scroll the text only once automatically when updated.

OFF: Does not scroll the text automatically.

Drawer Close

Sets whether to close the common menu [\(P.14\)](#) automatically. Default is "Auto".

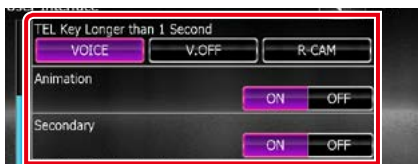

TEL Key Longer than 1 Second

You can set the operation performed when the TEL key is pressed for 1 second. Select from "Voice"/"V.OFF"/"R-CAM".

Voice (Default): Displays the Voice Recognition screen. [\(P.70\)](#).

V.OFF: Turn the display off.

R-CAM: Switches to the rear view camera video display.

Animation

Sets whether to display animation. Default is "ON".

Secondary

Sets whether to display the navigation information in the audio screen or vice versa. Default is "ON".

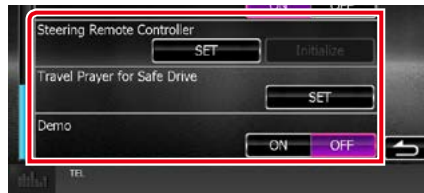

Steering Remote Controller

Sets the desired function in the steering remote controller. See [Learning function of steering remote \(P.75\)](#).

Travel Prayer for Safe Drive

Sets the prayer for driving safety is displayed when the unit is turned on, then Quran is played. See [Travel Prayer for Safe Drive Setting \(P.76\)](#).

DEMO

Set the demonstration mode. Default is "ON".

Language setup

1 Touch [SET] of [Language] in the User Interface screen.

Language Setting screen appears.

2 Set each item as follows.



Select Mode

Selects the mode to select a language.

Easy (Default): Selects a language easily.

Advanced: Allows you to select languages for respective items.*

Language Select

Selects a language.

* If you select [Advanced] for Select Mode, the following screen appears.



GUI Language Select:

Selects the display language used for the control screen and so forth.

Navigation Language Select:

Selects the language used for navigation.

Text Language Select:

Selects the language used for tag text (song information).

3 Touch [Enter].

NOTE

- To cancel the language setup, touch [Cancel].

Learning function of steering remote

This function is available only when your vehicle is equipped with the electrical steering remote controller.

If your steering remote controller is not compliant, learning may not be completed and error message may appear.

1 Touch [SET] of [Steering Remote Controller].

Steering Remote Controller Setting screen appears.

2 Press the steering remote controller button you want to set the function.

NOTE

- You can have the unit learned all buttons at a time. In that case, press the all buttons one at a time and after pressing all of them, touch [Done] in Steering Remote Controller Setting screen. However, new functions cannot be learned after this operation.

3 Touch the function you want to set.



4 Repeat steps 2 and 3 as necessary.

5 Touch [Done].

NOTE

- When changing the function already learned, touch the button you want to change in step 2 and then touch to select the changed function from the function list.
- Confirm the contents of the settable function on the function list. You cannot edit the function list.
- To initialize the contents, touch [Initialize] of [Steering Remote Controller] in User Interface screen. After you touch [Initialize], a confirmation message appears. Follow the message and complete the operation.

Travel Prayer for Safe Drive Setting (DNX4150BTM region code 2 area only)

When this function is set, the prayer for driving safety is displayed when the unit is turned on, then Quran is played.

1 Touch [SET] of [Travel Prayer for Safe Drive] in the User Interface screen.

Travel Prayer for Safe Drive Setting screen appears.

2 Set each item as follows.



Travel Prayer for Safe Drive

Turns the Safe drive pray function on or off.

Touch panel adjustment

1 Touch [Touch] in the System Menu screen.

Touch Panel Adjustment screen appears.

2 Follow the instruction on the screen and touch the center of each .

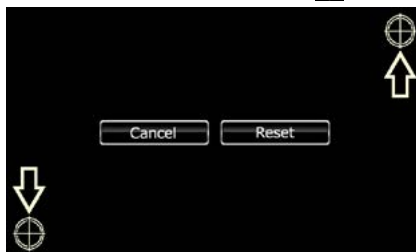

NOTE

- To cancel the touch panel adjustment, touch [Cancel].
- To reset to the initial status, touch [Reset].

Security setup

You can set up a security code to protect your receiver system against theft.

NOTE

- When the Security Code function is activated, the code cannot be changed and the function cannot be released. Note the Security Code can be set as the 4 digit number of your choice.

NOTE

- If you enter a different security code, the screen returns to step 4 (for the first code entry).
- If you have pressed <Reset> button or if you have disconnected the Receiver from battery, enter the correct security code as that you have entered in step 4 and touch [Enter]. You can use your receiver.

1 Touch [Security] in the System Menu screen.

Security screen appears.

2 Touch [ON] of [SI].



NOTE

- If "SI" is turned on, the SI indicator on the front panel flashes when the vehicle ignition is off. Default is "ON".

3 Touch [SET] of [Security Code Set].

NOTE

- If you have already completed the code registration, [CLR] is displayed.

4 Enter a security code with four-digit number and touch [Enter].

5 Enter the same code again and touch [Enter].

Security code is registered.

Setup memory

Audio Control, AV-IN SETUP, Camera, and Audio SETUP settings can be memorized. The memorized settings can be recalled at any time. For example, even when the settings are cleared due to replacement of the battery, the settings can be restored.

1 Touch [SETUP Memory] in the System Menu screen.

SETUP Memory screen appears.

2 Follow the instruction on the screen.

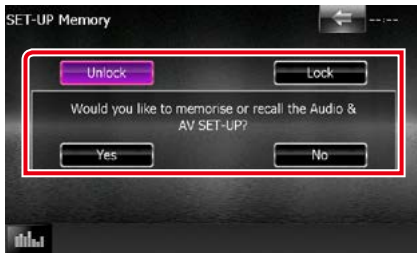

[Lock]/[Unlock]*

Locks or unlocks the AV-IN SETUP, and Audio SETUP settings.

Yes

Memorizes or recalls the settings.

No

Cancels the function or memorization.
The SETUP Menu screen appears again.

* When [Lock] is selected, you cannot change the AV-IN SETUP, and Audio SETUP settings. Also, the locked key mark is displayed under each setting icon in the setup menu.

3 Follow the instruction on the screen.



Recall

Recalls the memorized settings.

Memory

Memorizes the current settings.

Clear

Clears the currently memorized settings.

Cancel

Quits memorization/recalling of settings.

Display Setup

1 Press the volume knob.

Popup menu appears.

2 Touch [SETUP].

SETUP Menu screen appears.

3 Touch [Display].



Display Menu screen appears.

See the following section for each setting.

- **Adjust panel color** [\(P.79\)](#)
- **Changing background image** [\(P.80\)](#)

Panel color coordinate

You can set the screen and button illumination color.

The selectable items differ depending on the unit.

1 Touch [Color] in the Display Menu screen.

Color screen appears.

2 Touch [OFF] of [Panel Color Scan].

3 Touch [SET] of [Panel Color Coordinate].

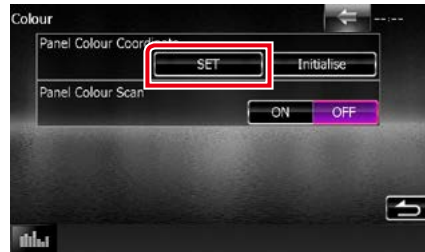

Panel Color Coordinate screen appears.

NOTE

- You can touch [SET] or [Initialize] when [Panel Color Scan] is set to off.
- Touch [Initialize] to reset the settings to the default settings.

4 Touch the desired color.

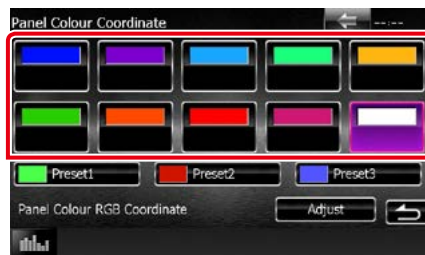

Registering original color

You can register your original color.

1 Touch [Adjust] in the Panel Color Coordinate screen.

Panel Color RGB Coordinate screen appears.

2 Use [◀] and [▶] to adjust each color value.

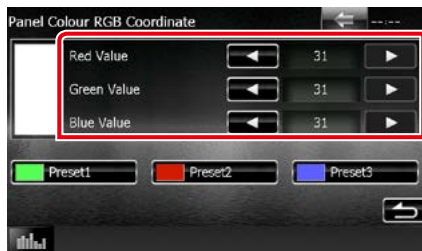

3 Touch the desired preset key for 2 seconds.

Panel color scan

You can set the panel color to continuously scan through the color spectrum.

1 Touch [ON] of [Panel Color Scan] in the Color screen.

Panel Color Scan is set to on.

Changing background image

You can load an image from the connected USB device and set it for the background image.

Before operating this procedure, it is necessary to connect the device which has the image to load.

1 Touch [Background] in the Display Menu screen.

Background screen appears.

2 Touch [STANDBY].



3 Touch [Memory] of [User Background].

User Background File Select screen appears.

4 Select the image to load.

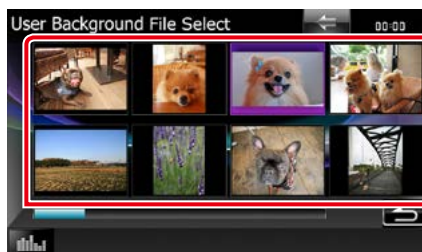

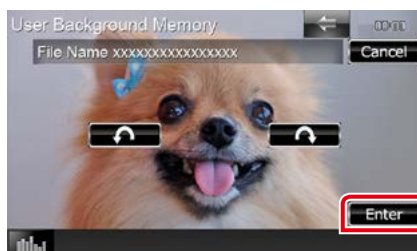

5 Touch [Enter].



The selected image is loaded and the

display returns to the Background screen.

NOTE

- Touching [] rotates counter clockwise.
- Touching [] rotates clockwise.

6 Touch [Change] of [Background Change] in the Background screen.

7 Select an image for background and touch [Enter].

NOTE

- See [Playable Media and Files \(P.106\)](#) for readable image specifications.
- Touching [Delete] in the Background screen deletes the background image. After you touch [Delete], a confirmation message appears. Follow the message and complete the operation.

Navigation Setup

You can set navigation parameters.

1 Press the volume knob.

Popup menu appears.

2 Touch [SETUP].

SETUP Menu screen appears.

3 Touch [Navigation].



Navigation SETUP screen appears.

4 Set each item as follows.



NAV Interrupt Speaker

Selects speakers used for voice guidance of the navigation system.

Front L: Uses the front left side speaker for voice guidance.

Front R: Uses the front right side speaker for voice guidance.

Front All (Default): Uses both front speakers for voice guidance.

NAV Voice Volume

Adjusts the volume for voice guidance of the navigation system. Default is "20".

NAV Mute

Mutes the volume of rear speakers during voice guidance of the navigation system. Default is "ON".

Camera Setup

You can set camera parameters.

1 Press the volume knob.

Popup menu appears.

2 Touch [SETUP].

SETUP Menu screen appears.

3 Touch [Camera].

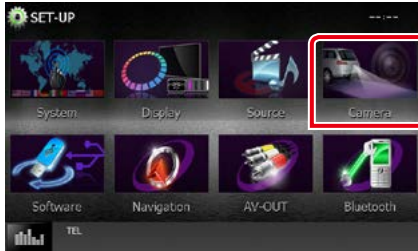

Camera SETUP screen appears.

4 Set each item as follows.



R-CAM Interruption

Sets a method for switching the display.
Setting values are ON and OFF.

ON: Switches to the rear view camera video display when shifting to reverse or pressing the <TEL>*1 button for 1 second.

OFF (Default): Switches to the rear view camera video display when pressing the <TEL>*1 button for 1 second.

Parking Guidelines*2

You can display parking guidelines to enable easier parking when you shift the gear to the reverse (R) position.
Default is "ON".

Guideline Setup*2

Adjust the parking guidelines. See [Adjusting the parking guidelines \(P.83\)](#).

*1 [TEL Key Longer than 1 Second] must be set to "R-CAM". See [User interface \(P.74\)](#)

*2 This setting becomes settable only when the "Rear Camera" is set to [Other].

Adjusting the parking guidelines

- 1 Touch [ON] of [Parking Guidelines] in the Camera SETUP screen.
- 2 Touch [Adjust] of [Guideline Setup] in the Camera SETUP screen.
- 3 Adjust the parking guidelines by selecting the  mark.



- 4 Adjusting the position of the selected  mark.

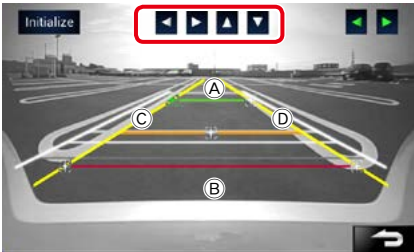

Make sure that (A) and (B) are horizontally parallel, and that (C) and (D) are the same length.

- Touch [Initialize] for 1 second to set all the  marks to the initial default position.

Software Information

Check the software version of this unit.

- 1 Press the volume knob.
Popup menu appears.
- 2 Touch [SETUP].
SETUP Menu screen appears.
- 3 Touch [Software].

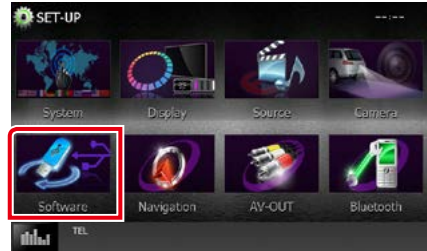

Software Information screen appears.

- 4 Confirm the software version. Touch [Update] as necessary.

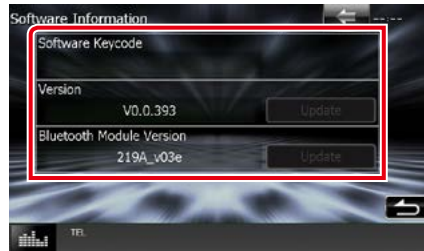

NOTE

- For how to update the software, see the relevant update procedure manual which comes with the software.

AV Input Setup

You can set AV input parameters.

1 Press the volume knob.

Popup menu appears.

2 Touch [SETUP].

SETUP Menu screen appears.

3 Touch [Source].

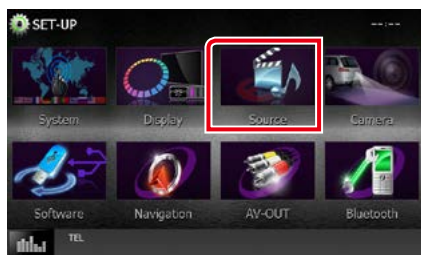

4 Touch [AV-IN SETUP] in the list.

AV-IN SETUP screen appears.

5 Set each item as follows.



TV Tuner Control

Sets when connecting the TV tuner to AV INPUT.

ON: Set to ON when connecting the 3rd party TV tuner. AV-IN Name is set to TV. If you connect the TV tuner made by DOS and watch TV, you can perform some simple operations by touching the screen of this unit.

OFF (Default): Set to OFF when not connecting the 3rd party TV tuner.

AV-IN1 Name/AV-IN2 Name

Sets a name to be displayed when you select a system that is connected via the AV INPUT port. Default is "VIDEO".

AV Output Interface Setup

You can select an AV source to be output at the AV OUTPUT port. Default is "VIDEO1".

1 Press the volume knob.

Popup menu appears.

2 Touch [SETUP].

SETUP Menu screen appears.

3 Touch [AV-OUT].

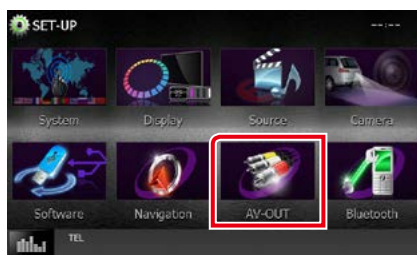

AV-OUT Interface screen appears.

4 Touch [◀] or [▶] to set [AV-OUT] to VIDEO1, DISC, iPod, USB, or OFF.

NOTE

- Only when you select "USB+AV-IN" in iPod Connection Setup, "USB" can be selected as AV output source. For the connection setting, refer to [iPod/iPhone connection setup \(P.46\)](#).

Controlling Audio

NOTE

- Each operation in this section can be started from the multi function menu.

You can adjust the various settings such as audio balance or subwoofer level.

1 Press the volume knob.

Popup menu appears.

2 Touch [Audio].

Audio screen appears.

See the following section for each setting.

- **Setting audio** ([P.86](#))
- **Controlling audio** ([P.90](#))
- **Controlling equalizer** ([P.91](#))
- **Performing zone control** ([P.92](#))
- **Set sound effect** ([P.93](#))
- **Set listening position** ([P.96](#))

Setting Audio

1 Press the volume knob.

Popup menu appears.

2 Touch [Audio].

Audio screen appears.

3 Touch [Audio SETUP].

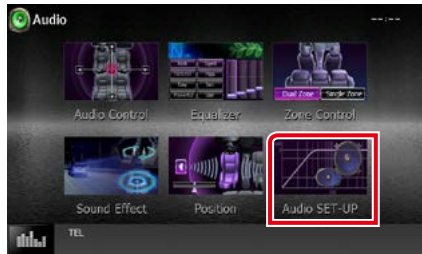

Audio SETUP screen appears.



See the following section for each setting.

- **Set up speakers** ([P.87](#))
- **Set up your car type** ([P.89](#))
- **Select DSP** ([P.90](#))

Speaker setup

You can select a speaker type and its size to get the best sound effects.

When the speaker type and size are set, the speaker crossover network is set automatically.

1 Touch [Speaker Select] in the Audio SETUP screen.

Speaker Select screen appears.



2 Touch the speaker you wish to adjust and set each item as follows.



Tweeter

You can set the tweeter when you are selecting front speakers.

None, Small, Middle, Large

X'over

Displays the speaker crossover setup screen. You can adjust the crossover setup that was set automatically when you selected the speaker type.

For details, see [Crossover network setup \(P.88\)](#)

3 Select a speaker size using [◀] and [▶]. The speaker size is different depending on the speaker type and the unit.

Front

OEM, 8 cm, 10 cm, 12 cm, 13 cm, 16 cm, 17 cm, 18 cm, 4x6, 5x7, 6x8, 6x9, 7x10

Rear

None, OEM, 8 cm, 10 cm, 12 cm, 13 cm, 16 cm, 17 cm, 18 cm, 4x6, 5x7, 6x8, 6x9, 7x10

Subwoofer

None, 16 cm, 20 cm, 25 cm, 30 cm, 38 cm over

NOTE

- Select "None" if you have no speakers.

When Speaker network is set to 3 way:
(DNX4150BT Region code 3 area only)

Tweeter

Small, Middle, Large

Mid Range

OEM, 8 cm, 10 cm, 12 cm, 13 cm, 16 cm, 17 cm, 18 cm, 4x6, 5x7, 6x8, 6x9, 7x10

Woofer

None, 16 cm, 20 cm, 25 cm, 30 cm, 38 cm over

NOTE

- For how to switch to the 3-way speaker system, see [3 way speaker system setup \(P.29\)](#) in the Quick Start Guide. Connecting 3-way speakers with the 2-way mode selected can break the speakers.
- Select "None" if you have no speakers.

Crossover network setup

You can set a crossover frequency of speakers.

- 1 Touch the speaker to set the crossover in the Speaker Select screen.
- 2 Touch [X'over].
X'over screen appears.
- 3 Set each item as follows.

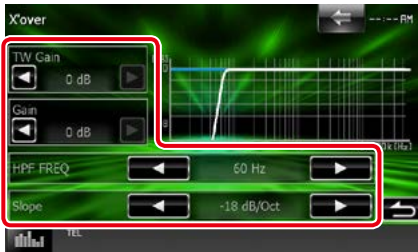

TW (Tweeter) Gain *1

Adjusts the tweeter level. (When front is selected on Speaker Select screen)

Gain

Adjusts the front speaker, rear speaker, or subwoofer level.

Phase*2

Sets the phase of subwoofer output.

The phase is reversed 180 degrees when set to "Reverse". (When subwoofer is selected on Speaker Select screen)

HPF FREQ

High Pass Filter adjustment. (When front or rear speaker is selected on Speaker Select screen)

LPF FREQ

Low Pass Filter adjustment. (When subwoofer is selected on Speaker Select screen)

Slope*3

Sets a crossover slope.

- *1 Only when "Tweeter" is set to "Small", "Middle", "Large" in <Speaker Setup>.
- *2 Only when "Subwoofer" is set to a mode other than "None" in <Speaker Setup>.
- *3 Only when "LPF FREQ"/"HPF FREQ" is set to a mode other than "Through" in <X'over>.

When Speaker network is set to 3 way:
(DNX4150BT Region code 3 area only)

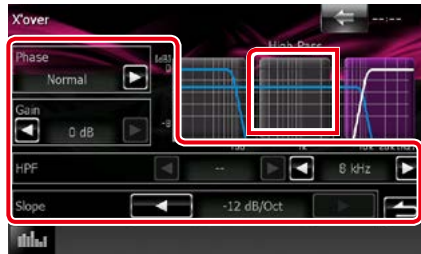

Range switching area (graph)

Selects the band for setting gain, frequency filter, and slope.

Touch the left arc to set the LPF, the center arc to set the BPF, and the right arc to set the HPF.

Phase*

Sets the phase of tweeter, mid range, and woofer output.

The phase is reversed 180 degrees when set to "Reverse".

Gain

Sets gain of each speaker.

HPF FREQ

High Pass Filter adjustment. (When tweeter is selected on Speaker Select screen)

BPF FREQ

Band Pass Filter adjustment. (When mid range speaker is selected on Speaker Select screen)

LPF FREQ

Low Pass Filter adjustment. (When woofer is selected on Speaker Select screen)

Slope

Sets a crossover slope.

NOTE

- For how to switch to the 3-way speaker system, see [3 way speaker system setup \(P.29\)](#) in the Quick Start Guide. Connecting 3-way speakers with the 2-way mode selected can break the speakers.

Car type setup

You can setup the car type and speaker network, etc.

1 Touch [Car Type] in the Audio SETUP screen.

Car Type screen appears.

2 Select your car type from the list.



NOTE

- If your car type is selected, the Delay Time Alignment is set automatically (for timing adjustment of sound output for each channel) to have the highest surround effects.

Speaker location setup

1 In the Car Type screen, touch [Location].

Speaker Location screen appears.

2 Select the speaker locations using [▶].



Front Speaker

Select the location from "Door"/"On Dash"/"Under Dash".

Rear Speaker

Select the location from "Door"/"Rear Deck", "2nd Row"/"3rd Row" (Minivan, Minivan (Long)).

When Speaker network is set to 3 way: (DNX4150BT Region code 3 area only)



Mid Range

Select the location from "Door"/"On Dash"/"Under Dash".

DSP select

You can select whether using DSP (Digital Signal Processor) System.

1 Touch [Bypass] or [Through] of [DSP Select] in the Audio SETUP screen.

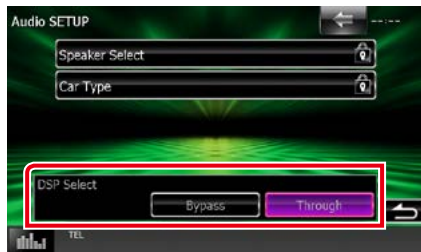

Bypass

There is no effect by DSP.

Through

There is an effect by DSP.

NOTE

- When the mode is set to [Bypass], DSP System cannot be adjusted.

Controlling General Audio

1 Press the volume knob.

Popup menu appears.

2 Touch [Audio].

Audio screen appears.

3 Touch [Audio Control].

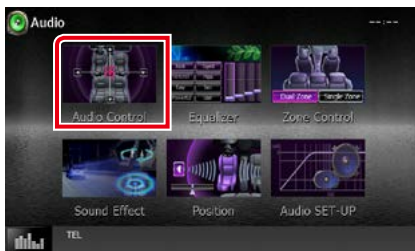

4 Set each item as follows.



Fader #/Balance

Adjust the volume balance around the touched area.

[◀] and [▶] adjust the right and left volume balance.

[▲] and [▼] adjust the front and rear volume balance.

Volume Offset*

Finely adjust the volume of the current source to minimize the difference in volume between different sources.

Subwoofer Level

Adjusts the subwoofer volume. This setting is not available when subwoofer is set to "None". See [Speaker setup \(P.87\)](#).

Bass Boost

Sets the amount of bass boost among "OFF"/"Level1"/"Level2"/"Level3".

* If you have increased the volume first, then reduced the volume using the “Volume Offset”, the sound generated if you suddenly switch to another source may be extremely loud.

Equalizer Control

You can adjust equalizer by selecting the optimized setting for each category.

1 Press the volume knob.

Popup menu appears.

2 Touch [Audio].

Audio screen appears.

3 Touch [Equalizer].



Equalizer screen appears.

Operation

Controlling EQ curves

1 Select EQ curve from [Natural], [Rock], [Pops], [Easy], [Top40], [Jazz], [Powerful], [iPod], and [User].

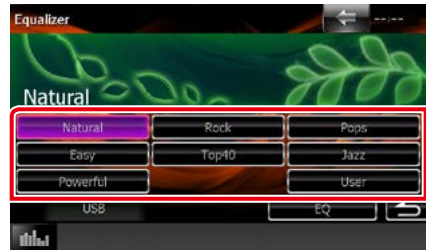

NOTE

• [iPod] is available only during iPod source.

Controlling equalizer manually

This setting cannot be performed when you select [iPod] in the Equalizer screen.

- 1 Touch [EQ] in the Equalizer screen.
- 2 Touch the screen and set the Graphic Equalizer as desired.

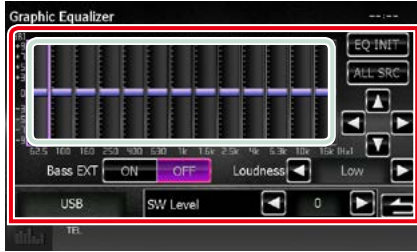

Gain level (light green boxed area)

Adjust the gain by touching the each frequency bar.

Touching [◀], [▶], [▲] and [▼] can also adjust the level. Use [◀] and [▶] to select a frequency, and [▲] and [▼] to set the level.

EQ INIT

Returns to the previous level which the gain level is adjusted.

ALL SRC

Apply the adjusted equalizer to all sources. Touch [ALL SRC] and then touch [OK] on the confirmation screen.

Bass EXT (Bass Extend Settings)

When turned on, the frequency lower than 62.5 Hz is set to the same gain level as 62.5 Hz.

Loudness

Sets the amounts of boost of low and high tones.

: "OFF", "Low", "High"

SW Level

Adjusts the subwoofer volume. This setting is not available when subwoofer is set to "None". See [Speaker setup \(P.87\)](#).

Zone Control

You can select different sources for both front and rear positions in the vehicle.

- 1 Press the volume knob.
Popup menu appears.
- 2 Touch [Audio].
Audio screen appears.
- 3 Touch [Zone Control].

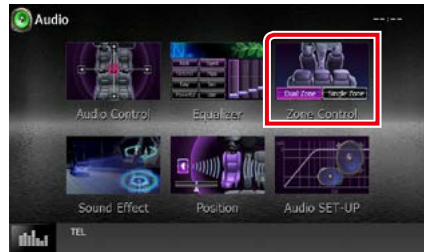

Zone Control screen appears.

- 4 Touch [Dual Zone].



- 5 Set each source as follows.



[▶] (Front Source, Rear Source)

Select the audio source for each.

[▼], [▲] (Rear VOL.)

Adjusts the rear channel volume.

[Single Zone]

Touch to turn off the dual zone function.

NOTE

- When the rear speaker sound is switched, the audio source that is output at the AV OUTPUT terminal is also switched to the same source.
- When the dual zone function is set to on, the following functions are not available.
 - Output from the subwoofer
 - Subwoofer Level/Bass Boost ([P.90](#))
 - Equalizer Control/ Sound Effect/ Listening Position ([P.91, 93, 96](#))
 - DSP Bypass Control/ Speaker Setup/Car Type Setup ([P.90, 87, 89](#))
- Different sources from iPod/iPhone (apps) cannot be set as front source and rear source separately. Only one source (app) can be set as front and rear sources.

Sound Effect

You can set sound effects.

- 1 Press the volume knob.**
Popup menu appears.
- 2 Touch [Audio].**
Audio screen appears.
- 3 Touch [Sound Effect].**



Sound Effect screen appears.



See the following section for each setting.

- **Set Space Enhancer** ([P.94](#))
- **Set Drive Equalizer** ([P.94](#))
- **Set up Sound Height Perception** ([P.95](#))
- **Set up Realizer or Supreme** ([P.95](#))

Space Enhancer

- 1 Touch **[Space Enhancer]** in the **Sound Effect** screen.



Space Enhancer screen appears.

- 2 Touch **[Small]**, **[Large]**, or **[OFF]**.
Each setting value indicates the soundscape level.

NOTE

- This setting is not available during HD Radio tuner source.

Drive Equalizer setting

The sound quality is automatically adjusted.

- 1 Touch **[ON]** or **[OFF]** of **[Drive Equalizer+]**.



The sound quality is automatically optimized to meet the current car speed by GPS.

Sound Height Perception

You can adjust the height of speakers virtually to suit your listening position.

- 1 Touch [Sound Height Perception] in the Sound Effect screen.

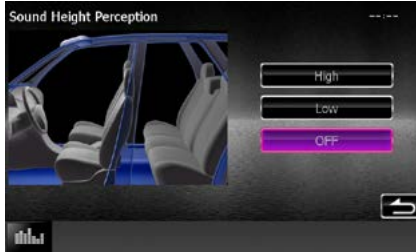

Sound Height Perception screen appears.

- 2 Select for the virtual height of speakers from [High], [Low], or [OFF].

Realizer and Supreme

You can restore the sound lost due to audio compression to a realistic sound.

- 1 Touch the screen in the Sound Effect screen.



Realizer

Realizer is sound enhancement and boosting low frequencies (bass boost).

Select the level from "OFF"/"Level1"/"Level2"/"Level3".

Supreme

Turns ON/OFF the Supreme function.

Technology to extrapolate and supplement with proprietary algorithm, the high-frequency range that is cut off when encoding.

This function works on DVD MEDIA, USB and iPod sources.

Listening Position

You can adjust the sound effects according to your listening position.

1 Press the volume knob.

Popup menu appears.

2 Touch [Audio].

Audio screen appears.

3 Touch [Position].

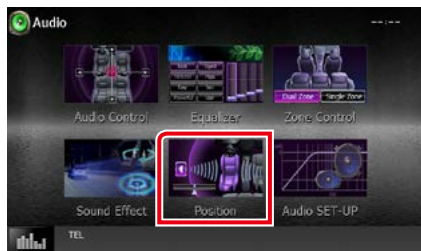

Position screen appears.

4 Select listening position from [Front R] (Right front), [Front L] (Left front), [Front All] (All front), and [All] using [◀] and [▶].



Position DTA control

You can fine-adjust your listening position.

1 In Position screen, touch [Adjust].

2 Select the speaker you wish to adjust by touching speaker icon.



3 Set DTA as follows.



[◀], [▶]

Adjust the settings of the DTA position.

Gain

Touch to adjust the gain of each speaker.

NOTE

- Make fine adjustment of the delay time of the speaker output specified here to have a more suitable environment for your vehicle.
- If you specify the distance from the center of the currently set listening position to every speaker, the delay time will be automatically computed and set.
 - ① Determine the center of the currently set listening position as the reference point.
 - ② Measure the distances from the reference point to the speakers.
 - ③ Calculate the differences between the distance of the furthest speaker and other speakers.
 - ④ Input the differences calculated in step ③ for individual speakers.
 - ⑤ Adjust gain for individual speakers. A sound image will be shifted to the speaker with increased gain.

Example: When [Front All] is selected as the listening position

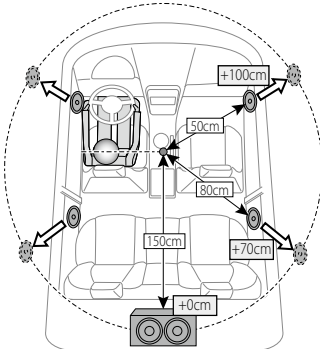

Remote control

This unit can be operated using the remote control.

▲ CAUTION

- Put the remote control in a place where it will not move during braking or other operations. A dangerous situation could result, if the remote control falls down and gets wedged under the pedals while driving.
- Do not leave the battery near fire or under direct sunlight. A fire, explosion or excessive heat generation may result.
- Do not recharge, short, break up or heat the battery or place it in an open fire. Such actions may cause the battery to leak fluid. If spilled fluid comes in contact with your eyes or on clothing, immediately rinse with water and consult a physician.
- Place the battery out of reach of children. In the unlikely event that a child swallows the battery, immediately consult a physician.

Battery Installation

If the remote control operates only over shorter distances or does not operate at all, it is possible that the batteries are depleted.

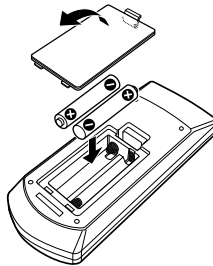

In such instances, replace the both batteries with new ones.

- 1 Insert two "AAA"/"R03"-size batteries with the ⊕ and ⊖ poles aligned properly, following the illustration inside the case.

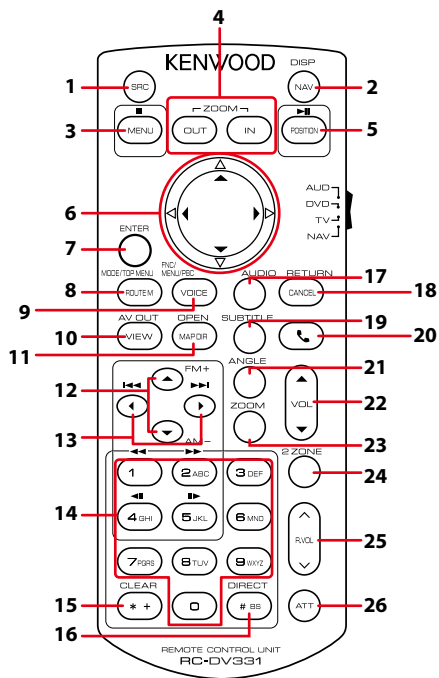



	Key Name	Location of the mode switch	Function
1	SRC	—	Switches to the source to be played. In hands-free mode, hangs up the phone.
2	NAV	—	Switches between the navigation and the source screens.
3	MENU	DVD	Stops playing and memorizes the last point where the disc stopped. The last point is deleted by pressing twice.
		NAV	Displays Main menu.
4	OUT, IN	NAV	Zooms in or out the navigation map.
5	POSITION	AUD, DVD	Pauses the track or file, and resumes playing by pressing twice. During radio source in AUD mode, switches the seek mode.
		NAV	Displays the current position.
6	Cursor Key	DVD	Moves the cursor in the DVD menu.
		NAV	Moves the cursor or scrolls the map.
7	ENTER	AUD, DVD	Performs the selected function.
		NAV	<ul style="list-style-type: none"> Registers the selected position. Performs the selected function.
8	ROUTE M	AUD	Screen mode changes each time you press this key during video playback.
		DVD	Returns to the DVD top menu.
		NAV	Displays Route Option menu.

	Key Name	Location of the mode switch	Function
9	VOICE	AUD	Switches navigation display on/off.
		DVD	Displays the DVD menu. Turns the playback control on or off while playing VCD.
		NAV	Speaks the voice guidance.
10	VIEW	AUD, DVD	Switches the AV source to be output.
		NAV	Switches between 2D and 3D map displays.
11	MAP DIR	NAV	Switches between the heading up navigation and north up navigation map displays.
12	▲/▼	AUD, DVD	Selects the folder to be played. During radio source in AUD mode, select FM/ AM band to be received.
13	◀▶	AUD, DVD	Selects the track or file to be played. During radio source in AUD mode, switches to broadcast stations received by the unit.
14	Numeric Keypad	AUD	Specifies the number to search in direct search. For details on the direct search mode, see Direct search mode (P.99) .
		DVD	<ul style="list-style-type: none"> • Press [1] [2] to fast forward/backward. Switches the fast forward/backward speed each time you press this key. • Press [4] [5] to slow forward/backward. Switches the slow playback speed each time you press this key.* *DVD only
15	* +	DVD	Clears the number.
16	# BS	AUD, DVD	Switches to the direct search mode. For details on the direct search mode, see Direct search mode (P.99) .
17	AUDIO	DVD	Switches the voice language each time you press this key.
18	CANCEL	DVD	Displays previous screen.
		NAV	Cancels the operations.
19	SUBTITLE	DVD	Switches the subtitle language.
20		–	When a call comes in, answers the call.
21	ANGLE	DVD	Switches the picture angle each time you press this key.
22	Vol ▲▼	–	Adjusts the volume.
23	ZOOM	DVD	Switches the zoom ratio (2, 3, 4, Off) each time you press this key.
24	2 ZONE	AUD, DVD	Switches the Dual Zone function on and off.
25	R.VOL 	–	Adjusts volume at rear when the Dual Zone function is on.
26	ATT	–	Lowers the volume by pressing the key once. Restores the previous volume by pressing the key twice.

Troubleshooting

Problems and Solutions

If any trouble occurs, first check the following table for possible problems.

- Some functions of this unit may be disabled by some settings made on this unit.
- What might seem to be a malfunction in your unit may just be the result of slight misoperation or miswiring.

About settings

Problem	Reason	Solution
<ul style="list-style-type: none"> • Cannot set up the subwoofer. • Cannot set up subwoofer phase. • No output from the subwoofer. • Cannot set up the low pass filter. • Cannot set up the high pass filter. 	Subwoofer is not set to on.	Set the subwoofer to on. See Speaker setup (P.87) .
	The dual zone function is enabled.	Set the dual zone function to off. See Zone Control (P.92) .
<ul style="list-style-type: none"> • Cannot select the output destination of the subsource in the dual zone. • Cannot adjust the volume of the rear speakers. 	The dual zone function is disabled.	Set the dual zone function to on. See Zone Control (P.92) .
<ul style="list-style-type: none"> • Cannot set up the equalizer. • Cannot set up the crossover network. 	The dual zone function is enabled.	Set the dual zone function to off. See Zone Control (P.92) .
	"DSP Select" is set to "Bypass".	Set "DSP Select" to "Through". See DSP select (P.90) .

About audio operations

Problem	Reason	Solution
Radio reception is poor.	The car antenna is not extended.	Pull out the antenna all the way.
	The antenna control wire is not connected.	Connect the wire correctly. See "Connection" in the Quick Start Guide.
Cannot play audio files stored in a disc.	"CD Read" is set to "2".	Set "CD Read" to "1". See Disc setup (P.26) .
Cannot select a folder.	The random play function is enabled.	Turn off the random function.
Cannot perform repeat play during VCD playback.	The PBC function is enabled.	Turn off the PBC function.
The specified disc does not play, but another one plays instead.	The disc is quite dirty.	Clean the disc. See Precautions on handling discs (P.4) .
	The disc is severely scratched.	Try another disc instead.

Problem	Reason	Solution
The sound skips when an audio file is being played.	The disc is scratched or dirty.	Clean the disc. See Precautions on handling discs (P.4) .
	The recording condition is bad.	Record the file again or use another disc.

Other

Problem	Reason	Solution
The Touch Sensor Tone doesn't sound.	The preout jack is being used.	The Touch Sensor Tone cannot be output from the preout jack.

Error Messages

When you fail to operate the unit correctly, the cause of the failure appears as the message on the screen.

Error Message	Cause	Solution
Protect	Protective circuit has been activated because a speaker cord has shorted or it has come in contact with the car chassis.	Wire or insulate the speaker cord as appropriate and then push the <Reset> button (P.105).
Hot Error	When the internal temperature of this unit rises to 60°C or more, the protection circuit is activated and you may not be able to operate the unit.	Use the unit again after reducing the temperature of the unit.
Mecha Error	The disc player is malfunctioning.	Eject the disc and try inserting it again. Contact the Kenwood dealer if this indicator continues blinking or the disc cannot be ejected.
Disc Error	An unplayable disc is inserted.	Change the disc. See Playable Media and Files (P.106) .
Read Error	The disc is quite dirty.	Clean the disc. See Precautions on handling discs (P.4) .
	Disc is upside down.	Load the disc with the labeled side up.
Region Code Error	The disc you wanted to play has a region code that cannot be played with this unit.	See Region Codes in the World (P.112) or try another disc.
Parental Level Error	The disc you wanted to play has a higher level than the parental level you set.	Set the parental level. See Parental level (P.26) .
Error 07–67	The unit is not operating correctly due to some reason or other.	Push the unit's Reset button. If the "Error 07–67" message does not disappear, see your nearest Kenwood dealer.
No Device (USB device, Bluetooth audio player)	The USB device is selected as a source although no USB device is connected.	Change the source to any source other than USB/iPod. Connect a USB device, and change the source to USB again.

Error Message	Cause	Solution
Disconnected (iPod)	The iPod/Bluetooth audio player is selected as a source although no iPod/Bluetooth audio player is connected.	Change the source to any source other than iPod/Bluetooth. Connect an iPod/Bluetooth audio player, and change the source to iPod/Bluetooth again.
No Media file	The connected USB device contains no playable audio file. Media was played that doesn't have data recorded that the unit can play.	See Playable Media and Files (P.106) and try another USB device.
USB Device Error!!	The connected USB device is rated a current capacity higher than the allowable limit.	Check the USB device. Some trouble may have occurred to the connected USB device. Change the source to any source other than USB. Remove the USB device.
Authorization Error	Connection to the iPod has failed.	<ul style="list-style-type: none">Remove the iPod and then reconnect it.The unit does not support the iPod. See Connectable iPod/iPhone (P.108).
Update your iPod	The iPod's software is an older version which the unit can not support.	The unit may not support the connected iPod model. Confirm that the software for the iPod is the latest version. See Connectable iPod/iPhone (P.108) .
Navigation Error. Please turn on power again later.	The communication error has occurred due to severely cold temperature.	Turn on power again after warming your car interior.
Antenna Error	The antenna has a short-circuit and the protective circuit has activated.	Check the Digital Radio antenna. If a passive antenna without a booster is used, set Antenna Power "OFF".

Resetting the Unit

If the unit or the connected unit fails to operate properly, reset the unit.

1 Press the <Reset> button.

The unit returns to factory settings.

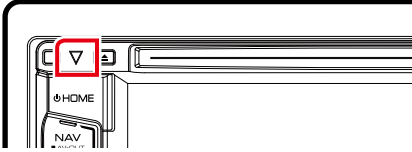

NOTE

- Disconnect the USB device before pressing the <Reset> button. Pressing the <Reset> button with the USB device connected can damage the data stored in the USB device. For how to disconnect the USB device, see [How to Play Media \(P.10\)](#).
- When the unit is turned on after resetting, the Initial SETUP screen appears. See [Initial setup \(P.8\)](#).

Appendix

Playable Media and Files

You can play various kinds of media and files on this unit.

List of playable discs

Disc types	Standard	Support	Remark
DVD	DVD Video	○	
	DVD Audio	×	
	DVD-VR	×	
	DVD-R*1	○	• MP3/WMA/AAC/MPEG1/MPEG2/DivX playback • Multi-border/Multisession playback (Playback depends on authoring conditions)
	DVD-RW	○	
	DVD+R	○	
	DVD+RW	○	
	DVD-R DL (Dual layer)	○	Only video format
	DVD+R DL (Double layer)	○	
DVD-RAM	×		
CD	Music CD*1	○	CD-TEXT
	CD-ROM	○	• MP3/WMA/AAC/MPEG1/MPEG2 playback • Multisession is supported. • Packet write is not supported.
	CD-R	○	
	CD-RW	○	
	DTS-CD	×	
	Video CD (VCD)	○	
	Super video CD	×	
	Photo CD	×	
	CD-EXTRA	△	Only music CD session can be played.
	HDCD	○	
CCCD	×		
Others	Dualdisc	×	
	Super audio CD	△	Only CD layer can be played.

*1 Incompatible with 8 cm (3 inch) discs.

○ : Playback is possible.

△ : Playback is partly possible.

× : Playback is impossible.

NOTE

- When buying DRM enabled contents, check the Registration Code in the [DivX\(R\) VOD \(P.45\)](#). Each time a file with the displayed code is played and protected against copying, the code changes.
- DivX can be played only from a DVD disc media.

■ Use of DualDisc

When playing a "DualDisc" on this unit, the surface of the disc that is not played may be scratched while the disc is inserted or ejected. Since the music CD surface does not conform to the CD standard, playback may be impossible.

(A "DualDisc" is a disc with one surface containing DVD standard signals and the other surface containing music CD signals.)

■ About disc format

The disc format should be the one of the following.

- ISO 9660 Level 1/2
- Joliet
- Romeo
- Long file name

About files

The following audio, video, and picture files are supported.

■ Audio files

- AAC-LC (.m4a)
- MP3 (.mp3)
- WMA (.wma)
- Linear PCM (WAVE) (.wav)
Mass-storage-class USB device only
- FLAC (.flac)
Mass-storage-class USB device only

NOTE

- If music of normal CD and other playback systems are recorded in the same disc, only the playback system recorded at the first setout is played.
- WMA and AAC of which is covered with DRM cannot be played.
- Although the audio files are complied with the standards listed above, the play may be impossible depending on the types or conditions of media or device.
- An online manual about audio files is put on the site, www.kenwood.com/cs/ce/audiofile/. On this online manual, detailed information and notes which are not written in this manual are provided. Make sure to read through the online manual as well.

■ Video files

- MPEG1 (.mpg, .mpeg, .m1v*)
*Mass-storage-class USB device only
- MPEG2 (.mpg, .mpeg, .m2v*)
*Mass-storage-class USB device only
- DivX (.divx, .div, .avi)
DVD only
- H.264/MPEG-4 AVC (mp4, .m4v)
Mass-storage-class USB device only
- WMV 9 (.wmv, .m2ts)
Mass-storage-class USB device only
- MKV (.mkv)
*Mass-storage-class USB device only

■ Picture files

Only picture files in USB tree can be displayed. Files stored in disc media is not supported.

- JPEG (.jpg, .jpeg)
- PNG (.png)
- BMP (.bmp)

NOTE

- BMP and PNG can be set only as wallpaper.

■ Playing order of files

In the example of folder/file tree shown below, the files are played in the order from ① to ⑩.

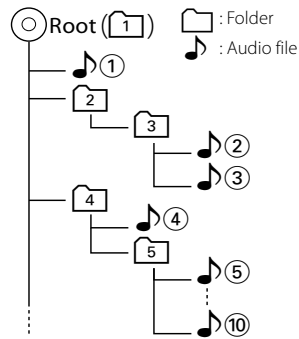

Connectable iPod/iPhone

The following models can be connected to this unit.

Made for

- iPhone 5s
- iPhone 5c
- iPhone 5
- iPhone 4S
- iPhone 4
- iPhone 3GS
- iPhone 3G
- iPhone
- iPod touch (5th generation)
- iPod touch (4th generation)
- iPod touch (3rd generation)
- iPod touch (2nd generation)
- iPod touch (1st generation)
- iPod classic
- iPod with video
- iPod nano (7th generation)
- iPod nano (6th generation)
- iPod nano (5th generation)
- iPod nano (4th generation)
- iPod nano (3rd generation)

NOTE

- For the details of the necessary cable and adapter to connect with iPod/iPhone, refer to [Music/Video/Picture Basic Operation \(P.28\)](#).
- For the conformity information on iPod/iPhone software, access www.kenwood.com/cs/ce/ipod/.
- By connecting your iPod/iPhone to this unit with an optional accessory iPod connection cable KCA-iP202 or KCA-iP102, you can supply power to your iPod/iPhone as well as charge it while playing music. However, the power of this unit must be on.
- If you start playback after connecting the iPod, the music that has been played by the iPod is played first.
In this case, "Reading" is displayed without displaying a folder name, etc. Changing the browse item will display a correct title, etc.
- When the iPod is connected to this unit, "KENWOOD" or "✓" is displayed on the iPod to indicate that you cannot operate the iPod.

Usable USB device

You can use a mass-storage-class USB device on this unit.

The word "USB device" appearing in this manual indicates a flash memory device and digital audio players can be recognized as mass-storage.

About file system

The file system should be the one of the following.

- FAT16
- FAT32

NOTE

- When the USB device is connected to this unit, it can be charged through the USB cable.
- Install the USB device in the place where it will not affect safe driving.
- You cannot connect a USB device via a USB hub and Multi Card Reader.
- Take backups of the audio files used with this unit. The files can be erased depending on the operating conditions of the USB device. We shall have no compensation for any damage arising from any erased data.
- No USB device comes with this unit. You need to purchase a commercially available USB device.
- When connecting the USB device, usage of the CA-U1EX (option) is recommended. (However, maximum supply current of CA-U1EX is 500mA.) Normal playback is not guaranteed when a cable other than the USB compatible cable is used.

Status Bar Indicator Items

Shown below is a list of indicators displayed on the status bar in the screen.

Current status of this unit is displayed on the bar.



Status bar

■ General

ATT

The attenuator is active.

DUAL

The dual zone function is on.

TEL

Indicates the connection state of the Bluetooth hands-free unit.

- White: Connected
- Orange: Not connected

MUTE

The mute function is active.

LOUD

The loudness control function is on.

■ DVD/CD

FO-REP

Folder repeat function is on.

IN

A disc is inserted.

- White: A Disc is inside the unit.
- Orange: Error at the disc player

VIDEO

Identifies the video file.

MUSIC

Identifies the music file.

RDM

The random function is on.

REP

The repeat function is on.

C-REP

The chapter repeat function is on.

T-REP

The title repeat function is on.

■ VCD

1chLL/2chLL

Identifies the left audio output of channel 1 or 2.

1chLR/2chLR

Identifies the monaural audio output of channel 1 or 2.

1chRR/2chRR

Identifies the right audio output of channel 1 or 2.

1chST/2chST

Identifies the stereo audio output of channel 1 or 2.

LL

Identifies the left audio output.

LR

Identifies the monaural audio output.

RR

Identifies the right audio output.

ST

Identifies the stereo audio output.

PBC

The PBC function is on.

VER1

The VCD version is 1.

VER2

The VCD version is 2.

REP

The repeat function is on.

■ USB

FO-REP

The folder repeat function is on.

VIDEO

Identifies the video file.

MUSIC

Identifies the music file.

PICTURE

Identifies the picture file.

RDM

The random function is on.

REP

The repeat function is on.

■ iPod

MUSIC

Identifies the music file.

VIDEO

Identifies the video file.

RDM

The random function is on.

A-RDM

The album random function is on.

REP

The repeat function is on.

■ Digital Radio

DAB

Digital Radio is being received.

RDS

Radio Data System is being received.

AUTO1

Seek mode is set to AUTO1.

AUTO2

Seek mode is set to AUTO2.

MANU

Seek mode is set to MANUAL.

MC

Receiving service is displayed.

- White: Primary Component is received.
- Orange: Secondary Component is received.

■ Tuner

AUTO1

Seek mode is set to AUTO1.

AUTO2

Seek mode is set to AUTO2.

MANU

Seek mode is set to MANUAL.

MONO

The forced monaural function is on.

EON*

The Radio Data System station is sending EON.

AF*

The AF search function is on.

LO.S*

The Local Seek function is on.

NEWS*

News bulletin interruption is in progress.

RDS*

Indicates the state of the Radio Data System station when the AF function is on.

- White: Radio Data System is being received.
- Orange: Radio Data System is not being received.

ST

A stereo broadcast is being received.

TI

Indicates the reception state of traffic information.

- White: TP is being received.
- Orange: TP is not being received.

Region Codes in the World

The DVD players are given a region code according to the country or area it is marketed, as shown in the following map.

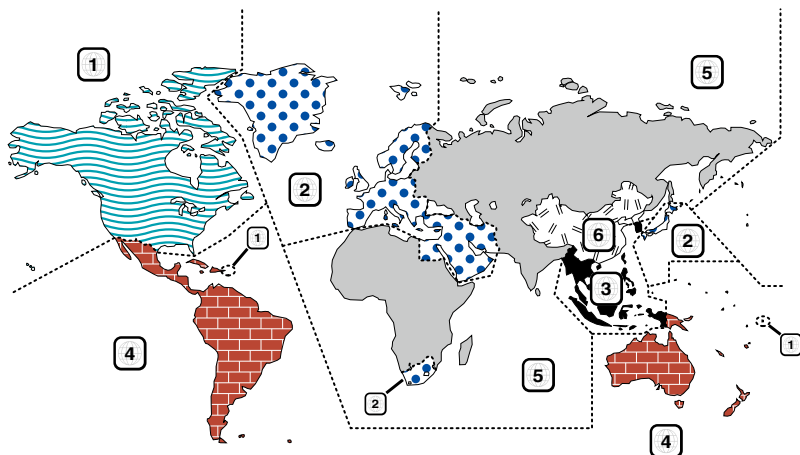

■ DVD disc marks



Indicates a region number. The discs with this mark can be played with any DVD player.



Indicates the number of audio languages recorded. Up to 8 languages can be recorded in a movie. You can select a favorite language.



Indicates the number of subtitled languages recorded. Up to 32 languages can be recorded.



If a DVD disc has scenes shot from multiple angles, you can select a favorite angle.

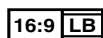

Indicates the type of screen for the image. The left mark indicates that a wide image picture (16:9) is displayed on a standard TV set screen (4:3) with a black band at both the top and bottom of the screen (letter box).

■ Operation regulatory marks

With this DVD, some functions of this unit such as the play function may be restricted depending on the location where the DVD is playing. In this case, the following marks will appear on the screen. For more information, refer to the disc manual.



■ Discs with limited period of use

Do not leave discs with a limited period of use in this unit. If you load an already expired disc, you may not be able to remove it from this unit.

DVD Language Codes

Code	Language
aa	Afar
ab	Abkhazian
af	Afrikaans
am	Amharic
ar	Arabic
as	Assamese
ay	Aymara
az	Azerbaijani
ba	Bashkir
be	Byelorussian
bg	Bulgarian
bh	Bihari
bi	Bislama
bn	Bengali, Bangla
bo	Tibetan
br	Breton
ca	Catalan
co	Corsican
cs	Czech
cy	Welsh
da	Danish
de	German
dz	Bhutani
el	Greek
en	English
eo	Esperanto
es	Spanish
et	Estonian
eu	Basque
fa	Persian
fi	Finnish
fj	Fiji
fo	Faroese
fr	French
fy	Frisian
ga	Irish
gd	Scots Gaelic
gl	Galician
gn	Guarani
gu	Gujarati
ha	Hausa
he	Hebrew
hi	Hindi
hr	Croatian
hu	Hungarian
hy	Armenian

Code	Language
ia	Interlingua
ie	Interlingue
ik	Inupiak
id	Indonesian
is	Icelandic
it	Italian
ja	Japanese
jav	Javanese
ka	Georgian
kk	Kazakh
kl	Greenlandic
km	Cambodian
kn	Kannada
ko	Korean
ks	Kashmiri
ku	Kurdish
ky	Kirghiz
la	Latin
lb	Luxembourgish
ln	Lingala
lo	Laotian
lt	Lithuanian
lv	Latvian, Lettish
mg	Malagasy
mi	Maori
mk	Macedonian
ml	Malayalam
mn	Mongolian
mo	Moldavian
mr	Marathi
ms	Malay
mt	Maltese
my	Burmese
na	Nauru
ne	Nepali
nl	Dutch
no	Norwegian
oc	Occitan
om	(Afan) Oromo
or	Oriya
pa	Punjabi
pl	Polish
ps	Pashto, Pushto
pt	Portuguese
qu	Quechua
rm	Rhaeto-Romance

Code	Language
rn	Kirundi
ro	Romanian
ru	Russian
rw	Kinyarwanda
sa	Sanskrit
sd	Sindhi
sg	Sangho
sh	Serbo-Croatian
si	Singhalese
sk	Slovak
sl	Slovenian
sm	Samoaan
sn	Shona
so	Somali
sq	Albanian
sr	Serbian
ss	Siswati
st	Sesotho
su	Sundanese
sv	Swedish
sw	Swahili
ta	Tamil
te	Telugu
tg	Tajik
th	Thai
ti	Tigrinya
tk	Turkmen
tl	Tagalog
tn	Setswana
to	Tongan
tr	Turkish
ts	Tsonga
tt	Tatar
tw	Twí
uk	Ukrainian
ur	Urdu
uz	Uzbek
vi	Vietnamese
vo	Volapuk
wo	Wolof
xh	Xhosa
yo	Yoruba
zh	Chinese
zu	Zulu

Specifications

■ Monitor section

Picture Size

: 6.2 inches (diagonal) wide
: 137.5 mm (W) x 77.2 mm (H)

Display System

: Transparent TN LCD panel

Drive System

: TFT active matrix system

Number of Pixels

: 1,152,000 (800H x 480V x RGB)

Effective Pixels

: 99.99 %

Pixel Arrangement

: RGB striped arrangement

Back Lighting

: LED

■ DVD player section

D/A Converter

: 24 bit

Audio Decoder

: Linear PCM/ Dolby Digital/ MP3/ WMA/ AAC

Video Decoder

: MPEG1/ MPEG2/ DivX

Wow & Flutter

: Below Measurable Limit

Frequency Response

- 96 kHz : 20 – 20,000 Hz
- 48 kHz : 20 – 20,000 Hz
- 44.1 kHz : 20 – 20,000 Hz

Total Harmonic Distortion

: 0.010 % (1 kHz)

S/N Ratio (dB)

: 98 dB (DVD-Video 96 kHz)

Dynamic Range

: 98 dB (DVD-Video 96 kHz)

Disc Format

: DVD-Video/ VIDEO-CD/ CD-DA

Sampling Frequency

: 44.1/ 48/ 96 kHz

Quantifying Bit Number

: 16/ 20/ 24 bit

■ USB interface section

USB Standard

: USB 2.0 High Speed

File System

: FAT 16/ 32

Maximum Power Supply Current

: DC 5 V  1 A

D/A Converter

: 24 Bit

Audio Decoder

: MP3/ WMA/ AAC/ WAV/ FLAC

Video Decoder

: MPEG1/ MPEG2/ MPEG4/ WMV/ H.264/mkv

■ Bluetooth section

Technology

: Bluetooth Ver. 3.0+EDR

Frequency

: 2.402 – 2.480 GHz

Output Power

: +4dBm (MAX), 0dBm (AVE), Power Class2

Maximum Communication range

: Line of sight approx. 10m (32.8 ft)

Audio Codec

SBC/ AAC/ MP3

Profile

- HFP (V1.6) (Hands Free Profile)
- SPP (Serial Port Profile)
- A2DP (Advanced Audio Distribution Profile)
- AVRCP (V1.4) (Audio/Video Remote Control Profile)
- HID (Human Interface Device Profile)
- PBAP (Phonebook Access Profile)
- GAP (Generic Access Profile)
- Multi Profile support

■ HDMI/ MHL section

HDMI

: HDMI Type-A

MHL Supported Version

: MHL 2

MHL Maximum Power Supply Current

: DC 5 V  900 mA

■ DSP section

Graphics equalizer

Band: 13 Band
Frequency (BAND1 – 13)
: 62.5/ 100/ 160/ 250/ 400/ 630/ 1k/ 1.6k/ 2.5k/ 4k/
6.3k/ 10k/ 16k Hz

Gain

: -9/-8/-7/-6/-5/-4/-3/-2/-1/0/1/2/3/4/5/6/7/8/9 dB

2Way X'Over

High pass filter

Frequency: Through, 30/ 40/ 50/ 60/ 70/ 80/ 90/ 100/
120/ 150/ 180/ 220/ 250 Hz
Slope: -6/-12/-18/-24 dB/Oct.

Low pass filter

Frequency: 30/ 40/ 50/ 60/ 70/ 80/ 90/ 100/ 120/
150/ 180/ 220/ 250 Hz, Through
Slope: -6/-12/-18/-24 dB/Oct.

3Way X'Over (DNX4150BT Region code 3 model)

High pass filter

Frequency: Through, 1k/ 1.6k/ 2.5k/ 4k/ 5k/ 6.3k/ 8k/
10k/ 12.5k Hz
Slope: -6/ -12 dB/Oct.

Band pass filter

Frequency: Through, 30/ 40/ 50/ 60/ 70/ 80/ 90/ 100/
120/ 150/ 180/ 220/ 250 Hz

Slope: -6/ -12 dB/Oct.

Frequency: 1k/ 1.6k/ 2.5k/ 4k/ 5k/ 6.3k/ 8k/ 10k/ 12.5k
Hz, Through

Slope: -6/ -12 dB/Oct.

Low pass filter

Frequency: 30/ 40/ 50/ 60/ 70/ 80/ 90/ 100/ 120/
150/ 180/ 220/ 250 Hz, Through

Slope: -6/-12 dB/Oct.

Position

Front / Rear /Subwoofer Delay

: 0 – 6.1 m (0.02 m Step)

Gain

: -8 – 0 dB

Subwoofer level

: -50 – +10 dB

■ FM tuner section

Frequency Range (step)

: 87.5 MHz – 108.0 MHz (50 kHz)

Usable Sensitivity (S/N : 26 dB)

Region code 2/3 model

: 0.63 μ V/75 Ω

Region code 4 model

: 7.2 dBf (0.63 μ V/75 Ω)

Quieting Sensitivity (S/N : 46 dB)

: 15.2 dBf (1.6 μ V/75 Ω)

Frequency Response (\pm 3.0 dB)

: 30 Hz – 15 kHz

S/N Ratio (dB)

: 75 dB (MONO)

Selectivity (\pm 400 kHz)

: Over 80 dB

Stereo Separation

: 45 dB (1 kHz)

■ AM tuner section

Frequency Range (step)

MW: 531 – 1611 kHz (9 kHz)

Usable Sensitivity

Region code 2/3 model: 25 μ V

Region code 4 model: 28 dB μ

■ Digital Radio section (DNX4150DAB)

Frequency Range

L-BAND: 1452.960 – 1490.624 (MHz)

BAND III: 174.928 – 239.200 (MHz)

Sensitivity

: -100 dBm

S/N Ratio (dB)

: 90 dB

■ Digital Antenna Connector section (DNX4150DAB)

Connector type

: SMB

Output Voltage (11 – 16V)

: 14.4 V

Maximum Current

: < 100 mA

■ **Video section**

Color System of External Video Input

: NTSC/PAL

External Video Input Level (mini jack)

: 1 Vp-p/ 75 Ω

External Audio Max Input Level (mini jack)

: 2 V/ 25 kΩ

Video Input Level (RCA jacks)

: 1 Vp-p/ 75 Ω

Video Output Level (RCA jacks)

: 1 Vp-p/ 75 Ω

Audio Output Level (RCA jacks)

: 1.2 V/ 10 kΩ

■ **Audio section**

Maximum Power (Front & Rear)

: 50 W x 4

Full Bandwidth Power (Front & Rear) (at less than 1%THD)

: 22 W x 4

Preout Level (V)

: 5 V/ 10 kΩ

Preout Impedance

: ≤ 250 Ω

Speaker Impedance

: 4 – 8 Ω

■ **Navigation section**

Receiver

: High-sensitivity GPS receiver

Reception Frequency

: 1575.42 MHz (C/A code)

Acquisition Times

Cold : 29 seconds (typ)

(All satellites at -130 dBm Without aiding)

Update Rate

: 1/second, continuous

Accuracy

Position: <2.5 meters, CEP, at -130 dBm

Velocity: 0.1 meter/sec

Position Method

: GPS

Antenna

: External GPS antenna

■ **General**

Operating Voltage

: 14.4 V (10.5 – 16 V allowable)

Maximum Current Consumption

: 10 A

Installation Dimensions (W x H x D)

: 182 x 112 x 156 mm

Operational Temperature Range

: -10 °C – +60 °C

Weight

: 2.0 kg

NOTE

- Although the effective pixels for the liquid crystal panel is given as 99.99% or more, 0.01% of pixels may not light or may light incorrectly.

Specifications subject to change without notice.

About this Unit

■ Copyrights

- The Bluetooth word mark and logos are owned by the Bluetooth SIG, Inc. and any use of such marks by JVC KENWOOD Corporation is under license. Other trademarks and trade names are those of their respective owners.
- The "AAC" logo is a trademark of Dolby Laboratories.
- "Made for iPod" and "Made for iPhone" mean that an electronic accessory has been designed to connect specifically to iPod or iPhone, respectively, and has been certified by the developer to meet Apple performance standards. Apple is not responsible for the operation of this device or its compliance with safety and regulatory standards. Please note that the use of this accessory with iPod, iPhone, or iPad may affect wireless performance.
- iPhone, iPod, iPod classic, iPod nano, and iPod touch are trademarks of Apple Inc., registered in the U.S. and other countries.
- iTunes is a trademark of Apple Inc.
-  is a trademark of DVD Format/Logo Licensing Corporation registered in the U.S., Japan and other countries.
- This item incorporates copy protection technology that is protected by U.S. patents and other intellectual property rights of Rovi Corporation. Reverse engineering and disassembly are prohibited.
- Manufactured under license from Dolby Laboratories. Dolby and the double-D symbol are trademarks of Dolby Laboratories.
- Android is a trademark of Google Inc.
- BlackBerry®, RIM®, Research In Motion® and related trademarks, names and logos are the property of Research In Motion Limited and are registered and/or used in the U.S. and countries around the world. Used under license from Research In Motion Limited.
- Adobe, Acrobat and Reader are either registered trademarks or trademarks of Adobe Systems Incorporated in the United States and/or other countries.
- QR Code ® is registered trademarks of DENSO WAVE INCORPORATED in JAPAN and other countries.
- DivX
This DivX Certified® device has passed rigorous testing to ensure it plays DivX® video.
To play purchased DivX movies, first register your device at vod.divx.com. Find your registration code in the DivX VOD section of your device setup menu. See [DivX\(R\) VOD \(P.45\)](#).
- DivX Certified® to play DivX® video, including premium content.
- DivX®, DivX Certified® and associated logos are trademarks of DivX, LLC and are used under license.
- The terms HDMI and HDMI High-Definition Multimedia Interface, and the HDMI logo are trademarks or registered trademarks of HDMI Licensing LLC in the United States and other countries.
- MHL and the MHL logo are a trademark or registered trademark of MHL, LLC.
 - Incorporates MHL 2
- "aupeo" is a trade mark of Aupeo GmbH.
- THIS PRODUCT IS LICENSED UNDER THE AVC PATENT PORTFOLIO LICENSE FOR THE PERSONAL USE OF A CONSUMER OR OTHER USES IN WHICH IT DOES NOT RECEIVE REMUNERATION TO (i) ENCODE VIDEO IN COMPLIANCE WITH THE AVC STANDARD ("AVC VIDEO") AND/OR (ii) DECODE AVC VIDEO THAT WAS ENCODED BY A CONSUMER ENGAGED IN A PERSONAL ACTIVITY AND/OR WAS OBTAINED FROM A VIDEO PROVIDER LICENSED TO PROVIDE AVC VIDEO. NO LICENSE IS GRANTED OR SHALL BE IMPLIED FOR ANY OTHER USE. ADDITIONAL INFORMATION MAY BE OBTAINED FROM MPEG LA, L.L.C. SEE [HTTP://WWW.MPEGLA.COM](http://www.mpegla.com)
- THIS PRODUCT IS LICENSED UNDER THE MPEG-4 VISUAL PATENT PORTFOLIO LICENSE FOR THE PERSONAL AND NON-COMMERCIAL USE OF A CONSUMER FOR (i) ENCODING VIDEO IN COMPLIANCE WITH THE MPEG-4 VISUAL STANDARD ("MPEG-4 VIDEO") AND/OR (ii) DECODING MPEG-4 VIDEO THAT WAS ENCODED BY A CONSUMER ENGAGED IN A PERSONAL AND NON-COMMERCIAL ACTIVITY AND/OR WAS OBTAINED FROM A VIDEO PROVIDER LICENSED BY MPEG LA TO PROVIDE MPEG-4 VIDEO. NO LICENSE IS GRANTED OR SHALL BE IMPLIED FOR ANY OTHER USE. ADDITIONAL INFORMATION INCLUDING THAT RELATING TO PROMOTIONAL, INTERNAL AND COMMERCIAL USES AND LICENSING MAY BE OBTAINED FROM MPEG LA, LLC. SEE [HTTP://WWW.MPEGLA.COM](http://www.mpegla.com).

• libFLAC

Copyright (C) 2000,2001,2002,2003,2004,2005,2006,2007,2008,2009 Josh Coalson

Redistribution and use in source and binary forms, with or without modification, are permitted provided that the following conditions are met:

- Redistributions of source code must retain the above copyright notice, this list of conditions and the following disclaimer.

- Redistributions in binary form must reproduce the above copyright notice, this list of conditions and the following disclaimer in the documentation and/or other materials provided with the distribution.

- Neither the name of the Xiph.org Foundation nor the names of its contributors may be used to endorse or promote products derived from this software without specific prior written permission.

THIS SOFTWARE IS PROVIDED BY THE COPYRIGHT HOLDERS AND CONTRIBUTORS "AS IS" AND ANY EXPRESS OR IMPLIED WARRANTIES, INCLUDING, BUT NOT LIMITED TO, THE IMPLIED WARRANTIES OF MERCHANTABILITY AND FITNESS FOR A PARTICULAR PURPOSE ARE DISCLAIMED. IN NO EVENT SHALL THE FOUNDATION OR CONTRIBUTORS BE LIABLE FOR ANY DIRECT, INDIRECT, INCIDENTAL, SPECIAL, EXEMPLARY, OR CONSEQUENTIAL DAMAGES (INCLUDING, BUT NOT LIMITED TO, PROCUREMENT OF SUBSTITUTE GOODS OR SERVICES; LOSS OF USE, DATA, OR PROFITS; OR BUSINESS INTERRUPTION) HOWEVER CAUSED AND ON ANY THEORY OF LIABILITY, WHETHER IN CONTRACT, STRICT LIABILITY, OR TORT (INCLUDING NEGLIGENCE OR OTHERWISE) ARISING IN ANY WAY OUT OF THE USE OF THIS SOFTWARE, EVEN IF ADVISED OF THE POSSIBILITY OF SUCH DAMAGE.

• **About Pandora®:**

Requirements for listening to the Pandora® are as follows:

iPhone or iPod touch

- Use an Apple iPhone or iPod touch running under iOS3 or later.
- Search for "Pandora" in the Apple App Store to find and install the most current version of the Pandora® application on your device.

Android™

- Visit the Google play and search for Pandora to install.

BlackBerry®

- Visit www.pandora.com from the built in browser to download the Pandora application.
- Bluetooth must be built in and the following profiles must be supported.
 - SPP (Serial Port Profile)
 - A2DP (Advanced Audio Distribution Profile)

NOTE

- In the application on your device, log in and create an account with Pandora.
- (If you are not already a registered user, an account can also be created at www.pandora.com.)
- Internet connection by LTE, 3G, EDGE, or WiFi.
- Pandora® is only available in the United States, Australia, and New Zealand.
- Because Pandora® is a third-party service, the specifications are subject to change without prior notice. Accordingly, compatibility may be impaired or some or all of the services may become unavailable.
- Some functions of Pandora® cannot be operated from this unit.
- For issues using the application, please contact Pandora® at pandora-support@pandora.com.

• **About AUPEO!:**

iPhone or iPod touch

- Install the latest version of the AUPEO! application on your iPhone or iPod touch. (Search for "AUPEO!" in the Apple iTunes App Store to find and install the most recent version.)

Android™

- Visit Google play and search for "AUPEO!" to install.

Note

- Ensure you are logged in to your smartphone application. If you do not have an AUPEO! account, you can create one for free from your smartphone or at www.aupeo.com.
- Because AUPEO! is a third-party service, the specifications are subject to change without prior notice. Accordingly, compatibility may be impaired or some or all of the services may become unavailable.
- Some functions of AUPEO! cannot be operated from this unit.
- For issues using the application, contact AUPEO! at www.aupeo.com.
- An active internet connection.

■ The marking of products using lasers



The label is attached to the chassis/case and says that the component uses laser beams that have been classified as Class 1. It means that the unit is utilizing laser beams that are of a weaker class. There is no danger of hazardous radiation outside the unit.

■ Eski Elektrik ve Elektronik Ekipmanların İmha Edilmesi Hakkında Bilgi (ayrı atık toplama sistemlerini kullanan ülkeleri için uygulanabilir)



Semböllü (üzerinde çarpı işareti olan çöp kutusu) ürünler ev atıkları olarak atılamaz.

Eski elektrik ve elektronik ekipmanlar, bu ürünleri ve ürün atıklarını geri dönüştürebilecek bir tesiste değerlendirilmelidir. Yaşadığınız bölgeye en yakın geri dönüşüm tesisinin yerini öğrenmek için yerel makamlara müracaat edin. Uygun geri dönüşüm ve atık imha yöntemi sağladığımız ve çevremiz üzerindeki zararlı etkileri önlerken kaynakların korunmasına da yardımcı olacaktır.

■ DNX4150BTM



Дата изготовления (месяц/год) находится на этикетке устройства.

■ DNX4150BTM



Declaration of Conformity with regard to the EMC Directive 2004/108/EC

Declaration of Conformity with regard to the R&TTE Directive 1999/5/EC

Declaration of Conformity with regard to the RoHS Directive 2011/65/EU

Manufacturer:

JVC KENWOOD Corporation
3-12, Moriyacho, Kanagawa-ku, Yokohama-shi,
Kanagawa 221-0022, JAPAN

EU Representative:

JVC KENWOOD NEDERLAND B.V.
Amsterdamseweg 37, 1422 AC UITHOORN, The
Netherlands

English

Hereby, JVC KENWOOD declares that this unit DNX4150BT, DNX4150BTM, DNX4150DAB is in compliance with the essential requirements and other relevant provisions of Directive 1999/5/EC.

Türkçe

Bu vesileyle JVC KENWOOD, DNX4150BT, DNX4150BTM, DNX4150DAB ünitesinin, 1999/5/EC Direktifinin başlıca gereksinimleri ve diğer ilgili hükümleri ile uyumlu olduğunu beyan eder.

■ For Turkey

Bu ürün 28300 sayılı Resmi Gazete'de yayımlanan Atık Elektrikli ve Elektronik Eşyaların Kontrolü Yönetmeliğe uygun olarak üretilmiştir.

[Return to the Top page](#)

[Appendix](#)

KENWOOD