

KENWOOD

DNX7150DAB **DNX715WDAB** **DNX4150DAB** **DNX4150BT** **DNX4150BTR**

GPS NAVIGATION SYSTEM

Quick Start Guide

JVCKENWOOD Corporation

You can update the system by connecting a USB device containing an update file.
For updating the system, visit <<http://www.kenwood.com/cs/ce/>>.

Contents

About the Quick start guide.....	2
Precautions	3
Safety Precautions and Important Information.....	5
First Step.....	6
Functions of the Buttons on the Front Panel.....	8
Detaching/ Attaching the faceplate and insert a SD Card.....	11
Common Operations.....	12
How to Use the Navigation System	13
How to Play Music.....	15
How to Play Movie/Picture.....	17
How to Listen to the DAB/ Radio	17
How to Make a Phone Call.....	18
Installation.....	19
About this Unit.....	27

About the Quick start guide

This Quick Start Guide describes basic functions of this unit.

For functions not described in this Guide, refer to the Instruction Manual on the following website:

<http://manual.kenwood.com/edition/im386/>



To refer to Instruction manual, a PC loaded with Microsoft® Windows XP/Vista/7/8 or Mac OS X® 10.4 or later is required in addition to Adobe® Reader™ 7.1 or Adobe® Acrobat® 7.1 or later.

The Instruction manual is subject to change for modification of specifications and so forth. Be sure to download the latest edition of the Instruction manual for reference.

NOTE

- The panels shown in this guide are examples used to provide clear explanations of the operations. For this reason, they may be different from the actual panels.
- In this manual, each model name is abbreviated as follows.
 - DNX7150DAB DNX715WDAB: **DNX7**
 - DNX4150DAB, DNX4150BT, DNX4150BTR: **DNX4**If above icons are showed, read the article applicable to the unit you use.
- In operation procedures, bracket shape indicates the key or button you should control.
 - < >: indicates the name of panel buttons.
 - []: indicates the name of touch keys

Precautions

⚠ WARNING

■ To prevent injury or fire, take the following precautions:

- To prevent a short circuit, never put or leave any metallic objects (such as coins or metal tools) inside the unit.
- Do not watch or fix your eyes on the unit's display when you are driving for any extended period.
- If you experience problems during installation, consult your Kenwood dealer.

■ Precautions on using this unit

- When you purchase optional accessories, check with your Kenwood dealer to make sure that they work with your model and in your area.
- You can select language to display menus, audio file tags, etc. See **Language setup (P.83)** in the Instruction Manual.
- The Radio Data System or Radio Broadcast Data System feature won't work where the service is not supported by any broadcasting station.
- The unit may not function properly if the connectors between the unit and front panel are dirty. Detach the front panel and clean the connector with a cotton swab gently, being careful not to damage the connector.

■ Precautions on battery

- Put the remote control in a place where it will not move during braking or other operations. A dangerous situation could result, if the remote control falls down and gets wedged under the pedals while driving.
- Do not leave the battery near fire or under direct sunlight. A fire, explosion or excessive heat generation may result.
- Do not recharge, short, break up or heat the battery or place it in an open fire. Such actions may cause the battery to leak fluid. If spilled fluid comes in contact with your eyes or on clothing, immediately rinse with water and consult a physician.
- Place the battery out of reach of children. In the unlikely event that a child swallows the battery, immediately consult a physician.

■ Protecting the monitor

- Put the remote control in a place where it will

not move during braking or other operations. A dangerous situation could result, if the remote control falls down and gets wedged under the pedals while driving.

■ Protecting the monitor

Put the remote control in a place where it will not move during braking or other operations. A dangerous situation could result, if the remote control falls down and gets wedged under the pedals while driving.

■ Lens fogging

When you turn on the car heater in cold weather, dew or condensation may form on the lens in the disc player of the unit. Called lens fogging, this condensation on the lens may not allow discs to play. In such a situation, remove the disc and wait for the condensation to evaporate. If the unit still does not operate normally after a while, consult your Kenwood dealer.

■ Precautions on handling discs

- Do not touch the recording surface of the disc.
- Do not stick tape etc. on the disc, or use a disc with tape stuck on it.
- Do not use disc type accessories.
- Clean from the center of the disc and move outward.
- When removing discs from this unit, pull them out horizontally.
- If the disc center hole or outside rim has burrs, use the disc only after removing the burrs with a ballpoint pen etc.
- Discs that are not round cannot be used.

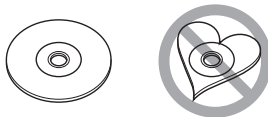

- 8-cm (3 inch) discs cannot be used.
- Discs with coloring on the recording surface or discs that are dirty cannot be used.
- This unit can only play the CDs with



This unit may not correctly play discs which do not have the mark.

- You cannot play a disc that has not been finalized. (For the finalization process see your writing software, and your recorder instruction manual.)

■ Acquiring GPS signal

The first time you turn on this unit, you must wait while the system acquires satellite signals for the first time. This process could take up to several minutes. Make sure your vehicle is outdoors in an open area away from tall buildings and trees for fastest acquisition.

After the system acquires satellites for the first time, it will acquire satellites quickly each time thereafter.

■ About the front panel **DNX7**

When removing the product from the box or installing it, the front panel may be positioned at the angle shown in (Fig. 1). This is due to the characteristics of mechanism the product is equipped with.

When the product is first powered on works properly, the front panel will automatically move into the position (initial setting angle) shown in (Fig. 2).

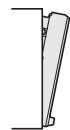

(Fig. 1)

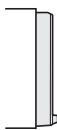

(Fig. 2)

■ Cleaning the Unit

If the front panel of this unit is stained, wipe it with a dry soft cloth such as a silicon cloth. If the front panel is stained badly, wipe the stain off with a cloth moistened with neutral cleaner, then wipe it again with a clean soft dry cloth.

⚠ CAUTION

- Applying spray cleaner directly to the unit may affect its mechanical parts. Wiping the front panel with a hard cloth or using a volatile liquid such as thinner or alcohol may scratch the surface or erase screened print.

■ How to reset your unit

If the unit or the connected unit fails to operate properly, reset the unit.

DNX7150DAB

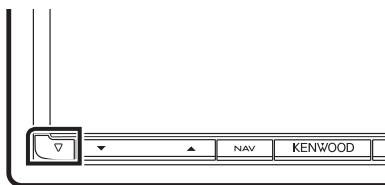

DNX715WDAB



DNX4

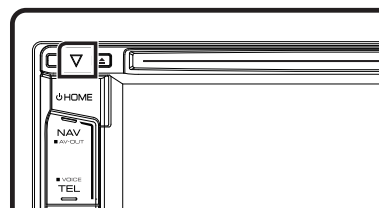

📎 NOTE

- Disconnect the USB device before pressing the <Reset> button. Pressing the <Reset> button with the USB device connected can damage the data stored in the USB device. For how to disconnect the USB device, see **How to Play Music (P.15)**.
- When the unit is turned on after resetting, the Initial SETUP screen appears. See **First Step (P.6)**.

Safety Precautions and Important Information

Read this information carefully before starting to operate the Kenwood Car Navigation System and follow the instructions in this manual. Neither Kenwood nor Garmin shall be liable for problems or accidents resulting from failure to observe the instructions in this manual.

⚠️ WARNING

Failure to avoid the following potentially hazardous situations could result in an accident or collision resulting in death or serious injury.

When navigating, carefully compare information displayed on the navigation system to all available navigation sources, including information from street signs, visual sightings, and maps. For safety, always resolve any discrepancies or questions before continuing navigation.

Always operate the vehicle in a safe manner.

Do not become distracted by the navigation system while driving, and always be fully aware of all driving conditions. Minimize the amount of time spent viewing the screen of the navigation system while driving, and use voice prompts when possible.

Do not enter destinations, change settings, or access any functions requiring prolonged use of the navigation system controls while driving. Stop your vehicle in a safe and legal manner before attempting such operations.

Keep the system volume at a low enough level to be able to hear outside noises while driving. If you can no longer hear outside noises, you may be unable to react adequately to the traffic situation. This may cause accidents.

The navigation system will not display the correct current position of the vehicle the first time it is used after purchase, or if the vehicle battery is disconnected. GPS satellite signals will soon be received, however, and the correct position will be displayed.

Be careful of the ambient temperature. Using the navigation system at extreme temperatures can lead to malfunction or damage. Also note that the unit can be damaged by strong vibration, by metal objects, or by water getting inside the unit.

⚠️ CAUTION

Failure to avoid the following potentially hazardous situations may result in injury or property damage.

The navigation system is designed to provide you with route suggestions. It does not reflect road closures or road conditions, weather conditions, or other factors that may affect safety or timing while driving.

Use the navigation system only as a navigational aid. Do not attempt to use the navigation system for any purpose requiring precise measurement of direction, distance, location, or topography.

The Global Positioning System (GPS) is operated by the United States government, which is solely responsible for its accuracy and maintenance. The government system is subject to changes that could affect the accuracy and performance of all GPS equipment, including the navigation system. Although the navigation system is a precision navigation device, any navigation device can be misused or misinterpreted and, therefore, become unsafe.

IMPORTANT INFORMATION

🔋 Vehicle Battery Preservation

This navigation system can be used when the ignition key is turned to ON or ACC. To preserve the battery, however, it should be used with the engine running whenever possible. Using the navigation system for a long time with the engine switched off can cause the battery to run down.

🗺️ Map Data Information

One of the goals of Garmin is to provide customers with the most complete and accurate cartography that is available to us at a reasonable cost. We use a combination of governmental and private data sources, which we identify in product literature and copyright messages displayed to the consumer. Virtually all data sources contain some inaccurate or incomplete data. In some countries, complete and accurate map information is either not available or is prohibitively expensive.

First Step

Various setup screens appear automatically before using.

Initial setup

When you first turn on the unit, the screen of the configuration setting will appear.

1 Turn the ignition key of your car to ACC.

The unit is turned on.
Initial SETUP screen appears.

2 Touch the corresponding key and set the value.



Locale

Select the country for the navigation system.
The language, the distance unit, and the gasoline unit are set.

Language

Select the language used for the control screen and setting items. Default is "British English (en)".
(Instruction Manual P.83)
After setting, touch [Enter].

Angle **DNX7**

Adjust the position of the monitor. Default is "0".
(Instruction Manual P.86)
After setting, touch [↵].

Color

Set the screen and button illumination color. You can select whether to perform color scan and adjust scanning color. (Instruction Manual P.87)
After setting, touch [↵].

Camera

Set the parameters for the camera. (Instruction Manual P.90)
After setting, touch [↵].

DEMO

Set the demonstration mode. Default is "ON".

3 Touch [Finish].

NOTE

- "Initial setup" also appears when the unit is reset.

📱 iPod/iPhone connection setup

When you first select iPod as a source, the setting screen of the iPod/iPhone connection will appear.

1 Press the <HOME> button.

HOME screen appears.

2 Touch [iPod] in the HOME screen.

iPod connection setup screen appears.

3 Touch [CHANGE].



Select the way of iPod/iPhone connection. For the details, refer to "iPod/iPhone connection setup" (P.54) in the Instruction Manual.

📎 NOTE

- For the details of the necessary cable and adapter to connect with iPod/iPhone, refer to "iPod/iPhone connection" (P.28).
- When you select "HDMI + BT" or "Bluetooth", Bluetooth device selection screen will appear. Select the iPod/iPhone to be connected.



If a connectable Bluetooth device is not displayed, touch [Search] and do the pairing of the devices.

- "iPod connection setup" also appears when the unit is reset.

📱 Application link setup

When you first select Apps as a source, the setting screen for the connection with the device installed the apps will appear.

1 Press the <HOME> button.

HOME screen appears.

2 Touch [APPS] in the HOME screen.

Application link setup screen appears.

3 Touch [CHANGE].



Select the way to connect with the device installed the apps. For the details, refer to "Application link setup" (P.56) in the Instruction Manual.

📎 NOTE

- For the details of the necessary cable and adapter to connect with iPod/iPhone and Android, refer to "iPod/iPhone connection" (P.28) and "Android connection" (P.28).
- When you select "HDMI + BT", "HDMI/MHL + BT" or "Bluetooth", Bluetooth device selection screen will appear. Select the device to be connected.



If a connectable Bluetooth device is not displayed, touch [Search] and do the pairing of the devices.

- "Application link setup" also appears when the unit is reset.

Functions of the Buttons on the Front Panel

■ DNX7150DAB

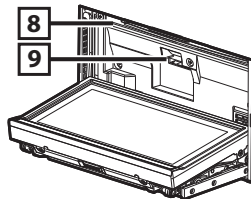
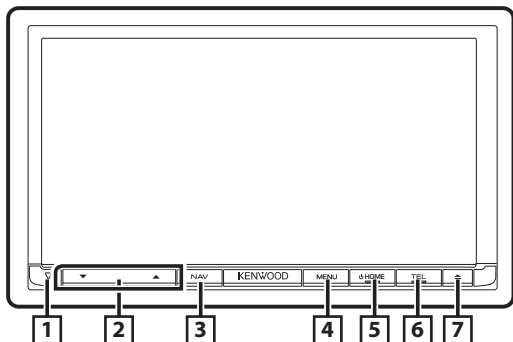

No.	Name/Motion
1	▽ (Reset) <ul style="list-style-type: none">• If the unit or the connected unit fails to operate properly, the unit returns to factory settings when this button is pressed (Instruction Manual P.113).• If the Security Indicator (SI) function is turned on, this indicator flashes when the panel is detached (Instruction Manual P.84).
2	▲, ▼ <ul style="list-style-type: none">• Adjusts volume.
3	NAV <ul style="list-style-type: none">• Displays the navigation screen.• Pressing for 1 second switches AV out sources.
4	MENU <ul style="list-style-type: none">• Displays the option menu screen.• Pressing for 1 second turns the screen off.*1
5	HOME <ul style="list-style-type: none">• Displays the HOME screen (Instruction Manual P.19).• Pressing for 1 second turns the power off.• When the power off, turns the power on.
6	TEL <ul style="list-style-type: none">• Displays the Hands Free screen (Instruction Manual P.75).• Pressing for 1 second displays the Voice Recognition screen. (Instruction Manual P.78)

No.	Name/Motion
7	▲ <ul style="list-style-type: none">• Ejects the disc.• When the panel is opened, pressing closes the panel and pressing for 1 second ejects the disc forcibly.• When the panel is closed, pressing for 1 second fully opens the panel to the location of the SD card slot.
8	Disc insert slot <ul style="list-style-type: none">• A slot to insert a disc media.
9	SD card slot <ul style="list-style-type: none">• A slot to insert an SD card. See Detaching/ Attaching the faceplate and insert a SD Card (P.11).• You can play audio/visual file in the card. *2• An SD card slot for upgrading the map. For how to upgrade the map, refer to the instruction manual of the navigation system.

*1 The function of the [MENU] button can be changed to camera view function. (Instruction Manual P.82).

*2 If the map update file remains in the SD card, you cannot play audio/visual file.

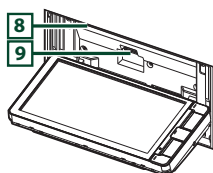
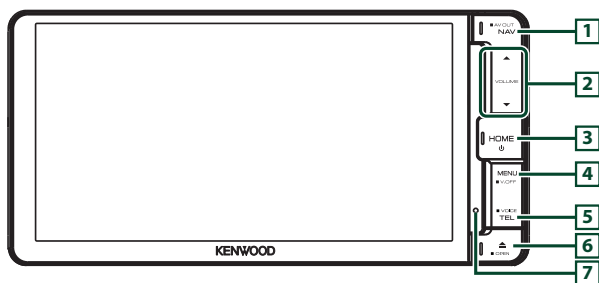

No.	Name/Motion
1	NAV <ul style="list-style-type: none"> • Displays the navigation screen. • Pressing for 1 second switches AV out sources.
2	▲, ▼ <ul style="list-style-type: none"> • Adjusts volume.
3	HOME <ul style="list-style-type: none"> • Displays the HOME screen (Instruction Manual P.19). • Pressing for 1 second turns the power off. • When the power off, turns the power on.
4	MENU <ul style="list-style-type: none"> • Displays the option menu screen. • Pressing for 1 second turns the screen off.*1
5	TEL <ul style="list-style-type: none"> • Displays the Hands Free screen (Instruction Manual P.75). • Pressing for 1 second displays the Voice Recognition screen. (Instruction Manual P.78)
6	▲ (Eject) <ul style="list-style-type: none"> • Ejects the disc. • Pressing for 1 second ejects the disc forcibly.
7	Reset <ul style="list-style-type: none"> • If the unit or the connected unit fails to operate properly, the unit returns to factory settings when this button is pressed (Instruction Manual P.113).
8	Disc insert slot <ul style="list-style-type: none"> • A slot to insert a disc media.

No.	Name/Motion
9	SD card slot <ul style="list-style-type: none"> • A slot to insert an SD card. • See Detaching/ Attaching the faceplate and insert a SD Card (P.11). • You can play audio/visual file in the card. *2 • An SD card slot for upgrading the map. • For how to upgrade the map, refer to the instruction manual of the navigation system.

*1 The function of the [MENU] button can be changed to camera view function. (Instruction Manual P.82).

*2 If the map update file remains in the SD card, you cannot play audio/visual file.

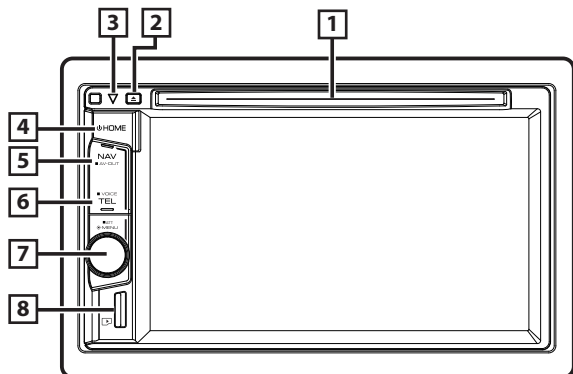

No.	Name/Motion
1	Disc insert slot <ul style="list-style-type: none"> • A slot to insert a disc media.
2	▲ (Eject) <ul style="list-style-type: none"> • Ejects the disc. • Pressing for 1 second ejects the disc forcibly.
3	▽ (Reset) <ul style="list-style-type: none"> • If the unit or the connected unit fails to operate properly, the unit returns to factory settings when this button is pressed (Instruction Manual P.113). • If the Security Indicator (SI) function is turned on, this indicator flashes when the vehicle ignition is off (Instruction Manual P.84).
4	HOME <ul style="list-style-type: none"> • Displays the HOME screen (Instruction Manual P.19). • Pressing for 1 second turns the power off. • When the power off, turns the power on.
5	NAV <ul style="list-style-type: none"> • Displays the navigation screen. • Pressing for 1 second switches AV out sources.
6	TEL <ul style="list-style-type: none"> • Displays the Hands Free screen (Instruction Manual P.75). • Pressing for 1 second displays the Voice Recognition screen.*1 (Instruction Manual P.78)

No.	Name/Motion
7	Volume knob <ul style="list-style-type: none"> • Turning adjusts volume up or down. • Displays the option menu screen. • Pressing for 1 second switches attenuation of the volume on/off.
8	microSD card slot <ul style="list-style-type: none"> • A slot to insert a microSD card. See Detaching/ Attaching the faceplate and insert a SD Card (P.11). • You can play audio/visual file in the card.*2 (DNX4150DAB/ DNX4150BT only) • A microSD card slot for upgrading the map. For how to upgrade the map, refer to the instruction manual of the navigation system.

*1 [TEL] button can also be used to switch to the rear view camera or turn off the display. (Instruction Manual P.82).

*2 If the map update file remains in the microSD card, you cannot play audio/visual file.

Detaching/ Attaching the faceplate and insert a SD Card

■ DNX7150DAB

• Detaching the faceplate

- 1) Press <▲> button for 1 second.
The panel fully opens.

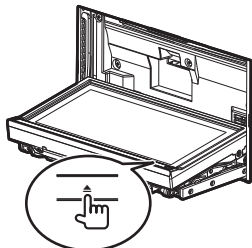

- 2) Detach the panel as the diagrams below.

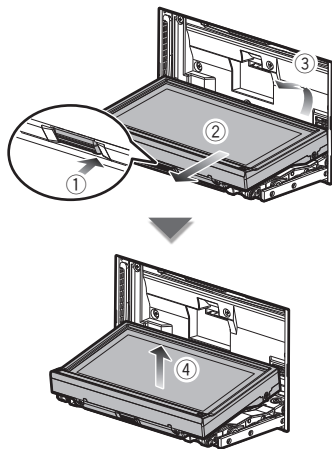

• Insert an SD Card

- 1) Press <▲> button for 1 second.
The panel fully opens.
- 2) Hold the SD card with the label facing up, and insert it into the slot until it clicks.

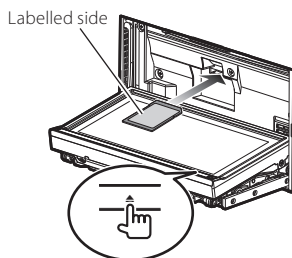

• Attaching the faceplate

- 1) Hold the front panel securely so as not to drop it accidentally. Fit the panel onto the attaching plate until it is firmly locked.

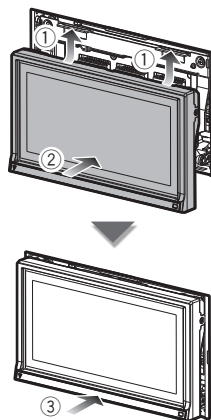

📎 NOTE

- The attaching plate closes automatically in about 10 seconds after the front panel is released. Remove the panel before this happens.

■ DNX715WDAB

• Insert an SD Card

- 1) Press <▲> button for 1 second.
The panel fully opens.
- 2) Hold the SD card with the label facing up, and insert it into the slot until it clicks.

Labelled side

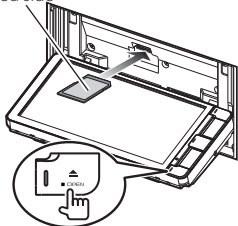

■ DNX4

• Insert a microSD Card

- 1) Hold the microSD card with the label side facing right and the notched section down, and insert it into the slot until it clicks.

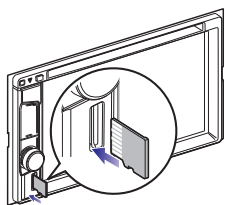

■ Eject an SD Card/ microSD Card

- 1) Push the card until it clicks and then remove your finger from the card.
- 2) The card pops up so that you can pull it out with your fingers.

Common Operations

■ Popup menu

- 1 Press the **DNX7** <MENU> button/ **DNX4** Volume knob.



Touch to display the popup menu. The contents of the menu are as follows.

- : Displays the Screen Adjustment screen.
- : Turns the display off.
- : Displays the camera view.
- : Displays the SETUP Menu screen.
- : Displays the Audio Control Menu screen.
- : Displays the control screen of current source.
Icon feature differs depending on the source.

■ General

There are some functions which can be operated from most screens.



(Graphic Equalizer)

Displays Graphic Equalizer screen.

(RETURN)

Returns to previous screen.

(common menu key)

Touch to display the common menu. The contents of the menu are as follows.

 : Displays the SETUP Menu screen.

 : Displays the Audio Control Menu screen.

 : Displays the control screen of current source.
Icon feature differs depending on the source.

 : Closes the menu.

List screen

There are some common function keys in the list screens of most sources.



(Scroll)

Scrolls the displayed text.

etc.

Touch keys with various functions are displayed here.

Displayed keys differ depending on the current audio source, status, etc.

For examples, see **List screen (P.22)** in the Instruction Manual.

Flick scrolling

You can scroll the list screen by flicking the screen up/down or right/left.

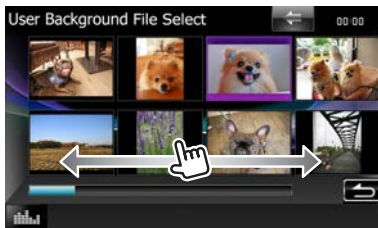
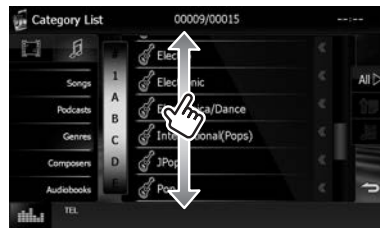

How to Use the Navigation System

1 Press the <NAV> button to display the navigation screen.

2 Operate the desired function from the Main Menu screen.



No.	Name/Motion
1	GPS satellite strength.
2	Finds a destination.
3	Views the map.
4	Uses the Apps such as ecoRoute and Help.
5	Adjusts the settings.

NOTE

- You can get additional information about using the navigation system from Help. To display Help, touch [Apps] and then touch [Help].

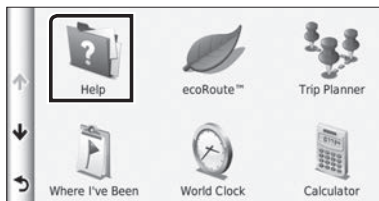

- For more information about your navigation system, download the latest version of the Owner's Manual from <http://manual.kenwood.com/edition/im386/>.

3 Enter your destination and start the guidance.

• Finding points of interest

- Touch [Where To?].
- Select a category and a subcategory.
- Select a destination.
- Touch [Go!].

NOTE

- To enter letters contained in the name, touch the Search bar and enter the letters.

4 Follow your route to the destination.

NOTICE

- The speed limit icon feature is for information only and does not replace the driver's responsibility to abide by all posted speed limit signs and to use safe driving judgment at all times. Garmin and JVC KENWOOD will not be responsible for any traffic fines or citations that you may receive for failing to follow all applicable traffic laws and signs.

Your route is marked with a magenta line. As you travel, your navigation system guides you to your destination with voice prompts, arrows on the map, and directions at the top of the map. If you depart from the original route, your navigation system recalculates the route.

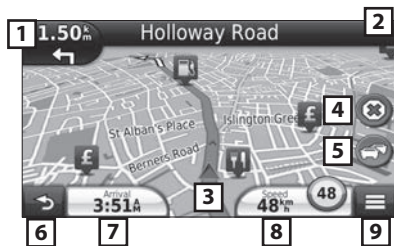

No.	Name/Motion
1	Views the Next Turn page or the junction view page, when available.
2	Views the Turn List page.
3	Views the Where Am I? page.
4	Stops the current route.
5	Displays traffic information on the route.
6	Returns to the Main menu.
7	Displays a different data field.
8	Views the Trip Computer.
9	Displays more options.

NOTE

- Touch and drag the map to view a different area of the map.
- A speed limit icon could appear as you travel on major roadways.

• Adding a stop

- While navigating a route, touch [↶] and then touch [Where To?].
- Search for the extra stop.
- Touch [Go!].
- Touch [Add to Active Route] to add this stop before your final destination.

• Taking a detour

- While navigating a route, touch [☰].
- Touch [↔].

■ Other Features

• Manually avoiding traffic on your route

- From the map, touch the traffic icon.
- Touch [Traffic On Route].
- If necessary, touch the arrows to view other traffic delays on your route.
- Touch [☰] > [Avoid].

• Viewing the traffic map

- 1) The traffic map shows color-coded traffic flow and delays on nearby.

• About traffic

NOTICE

- Traffic service is not available in some areas or countries.
- Garmin and JVC KENWOOD are not responsible for the accuracy or timeliness of the traffic information.
- You can receive INRIX traffic information and weather forecast by connecting your iPhone or Android smartphone in which the "KENWOOD Traffic Powered By INRIX" application is installed. (except DNX4150BTR) For details, see "KENWOOD Traffic Powered By INRIX" application.
- With an FM traffic receiver, the navigation system can receive and use traffic information. The FM TMC subscription activates automatically after your navigation system acquires satellite signals while receiving traffic signals from the service provider. Go to www.garmin.com/kenwood for more information.
- While receiving INRIX traffic information, FM TMC information is not displayed.

• Updating the software

To update the navigation system software, you must have an SD card, a USB mass storage device and an internet connection.

- 1) Go to www.garmin.com/kenwood.
- 2) Select Update.
- 3) Follow the on-screen instructions.

• Updating maps

You can purchase updated map data from Garmin or ask your Kenwood dealer or Kenwood service center for details.

- 1) Go to www.garmin.com/kenwood.
- 2) Select Update.
- 3) Follow the on-screen instructions.

How to Play Music

You can play audio files from music CD, disc media, USB storage device, SD Card, and iPod.

NOTE

- For details on playable file format, media format, iPod model, etc., refer to the Instruction Manual.

1 Connect the media you want to play as shown below.

Disc

DNX7

- 1) Press the <▲> button to open the front panel.
- 2) Insert the disc into the slot.
The panel closes automatically and playback starts.

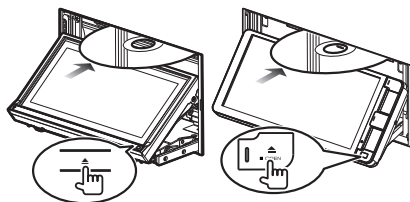

• To eject the disc:

- 1) Press the <▲> button.

DNX4

- 1) Insert the disc into the slot.
Playback starts.

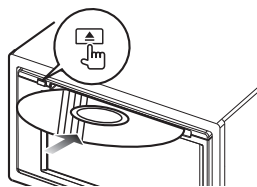

• To eject the disc:

- 1) Press the <▲> button.

iPod/iPhone

- 1) Connect the iPod/iPhone.
- 2) Press the <HOME> button.
- 3) Touch [iPod].

NOTE

- For the details of the necessary cable and adapter to connect with iPod/iPhone, refer to "iPod/iPhone connection" (P.28).

• **To disconnect the iPod/iPhone connected with the cable:**

- 1) Touch on the left side of the screen to display the function panel.
- 2) Touch [▲]. Disconnect the iPod/ iPhone from the cable.

USB device

- 1) Connect the USB device with the USB cable.

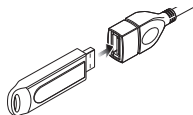

• **To disconnect the USB device:**

- 1) Touch on the left side of the screen to display the function panel.
- 2) Touch [▲]. Disconnect the device from the cable.

SD card/ microSD card (DNX7/ DNX4150DAB/ DNX4150BT)

- 1) Insert the SD card/ microSD card.
- 2) Replace the front panel.
Playback starts.

NOTE

- To insert SD card or microSD card, refer to "Detaching/ Attaching the faceplate and insert a SD Card" (P.11).

2 Control the music you are listening to on the source control screen.

The following symbols indicate the keys on the screen.

The functions of the keys are the same despite the difference of the source you are listening to.



Touch on the left side of the screen to display the function panel.



• **Basic operations from this screen**

- ▶||**
Plays or pauses.
- ◀◀◀▶▶▶**
Searches the previous/next content.
- ◀◀▶▶▶ or move the cursor in the center bar**
Fast forwards or Fast backwards (Disc media, CD, USB device, SD only).
- ↺**
Repeats current content.
- ⋈**
Plays all contents in random order.
- [+] [-]**
Searches previous/next folder. (disc media and USB device, SD only)
- Stops playing. (disc media only)
- ▲**
Disconnects the device. (USB device and iPod only)

NOTE

- For other operations, refer to the Instruction Manual.

3 Search the track/file you want to listen to.

• **List search**

- 1) Touch on the right side of the screen. The content list of the media being played is displayed.



• Refined search

- 1) Touch [Q].
- 2) Touch the desired refinement method.
The list is refined by the item you selected.
- 3) Touch the desired item.



NOTE

- For details on searching operations, refer to **Search Operation (P.42)** in the Instruction Manual.

How to Play Movie/Picture

You can play DVD video, Video CD (VCD), movie files from disc media, iPod and picture files from SD Card, USB storage device.

NOTE

- For details on playable file format, device format, etc., refer to the Instruction Manual.

1 Connect the media you want to play.

For the method of connecting, see **How to Play Music (P.15)**.

2 Control the movie/picture by touching the screen.

Each area on the screen has a separate function.

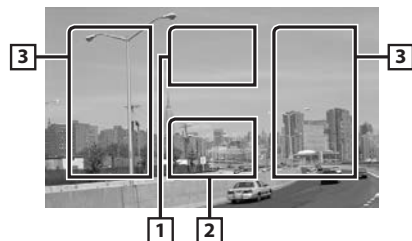

No.	Name/Motion
1	Displays the movie control screen.
2	Displays the Source Control screen.

No.	Name/Motion
3	<ul style="list-style-type: none"> • Searches the next/previous content or file. • Scrolling from center of display to left or right performs fast backward or fast forward. To stop fast backward/forward, touch center of the display.*1

*1 For USB/ SD Card, this function may be unavailable depending on the playing file format.

NOTE

- For operations on the source control screen, see **How to Play Music (P.15)**. However, searching by category/link/album artwork is not available.

How to Listen to the DAB/ Radio

1 Press the <HOME> button.

HOME screen appears.

2 Touch [DAB] (DNR), DNX4150DAB only or [TUNER].

The unit switches to the radio source.

3 Operate on the source control screen.

- Station search for DAB



- 1) Touch [◀▶] or [▶▶] to tune in the desired ensemble, service, or component.

- Station search for Radio



- 1) Touch [AM/FM] to select the band.
- 2) Touch [◀▶] or [▶▶] to tune in the desired station.

• Auto memory (Radio only)

- 1) Touch [AM/FM] to select the band.
- 2) Flick the screen from the left end to right to display the function panel.
- 3) Touch [AME].
- 4) Touch [◀◀] or [▶▶].
Auto memory starts.

• Recalling the preset station

- 1) Touch [P#] (#:1-15), [FM#] (#:1-15) or [AM#] (#:1-5).

NOTE

- For other operations, see **Radio Basic Operation (P.58)**, **Digital Radio Basic Operation (P.60)** in the Instruction Manual.

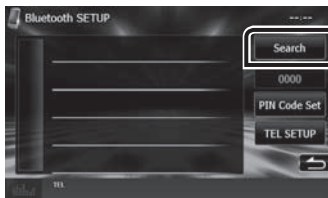

- 7) Select your cell-phone from the displayed list in the Searched Device List screen.
- 8) Enter PIN code for the cell-phone. Registering is completed.
The PIN code is set to "0000" as default.

2 Connect your cell-phone to the unit.

- 1) Touch the device name you want to connect in the Bluetooth SETUP screen.
- 2) Touch [ON] of [TEL(HFP)] in the BT Connection Settings screen.
The selected device is connected to the unit.



When registration of your cell-phone is completed, the phone book of the cell-phone is automatically downloaded to this unit.

3 Make or receive a phone call.

See the table below for each operation method.



Call by entering a phone number

- 1) Enter a phone number with number keys.
- 2) Touch [☎].

How to Make a Phone Call

You can use your Bluetooth cell-phone when paired to this unit.

NOTE

- You cannot register the Bluetooth unit when you are using the following sources:
iPod, Bluetooth Audio, APPS, aha, AUPEO

1 Register your cell-phone to the unit.



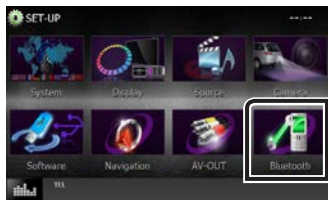

Follow as the procedures shown below. For detailed operation, see **Registering the Bluetooth Unit (P.71)** in the Instruction Manual.

- 1) Press the <HOME> button.
HOME screen appears.
- 2) Touch [STANDBY].
- 3) Press the **DNX7** <MENU> button/**DNX4** volume knob.
Popup menu appears.
- 4) Touch [SETUP].
SETUP Menu screen appears.
- 5) Touch [Bluetooth].
Bluetooth SETUP screen appears.





- 6) Touch [Search].
Searched Device List screen appears.

Call using call records

- 1) Touch [] (incoming calls), [] (missed calls), or [] (outgoing calls).
- 2) Select the phone number from the list.
- 3) Touch [].

Call using the phonebook

- 1) Touch [].
- 2) Select the name from the list.
- 3) Select the number from the list.
- 4) Touch [].

Call using the preset number

- 1) Touch [Preset #] to start calling the corresponding phone number.
- 2) Touch [].

Call by voice

You can make a voice call using the voice recognition function of the cell-phone.

- 1) Touch [].
- 2) Pronounce the name registered in the cell-phone.

NOTE

- For detailed operation, see **Using Hands-Free Unit (P.75)** in the Instruction Manual.

Installation

Before Installation

Before installation of this unit, please note the following precautions.

WARNINGS

- If you connect the ignition wire (red) and the battery wire (yellow) to the car chassis (ground), you may cause a short circuit, that in turn may start a fire. Always connect those wires to the power source running through the fuse box.
- Do not cut out the fuse from the ignition wire (red) and the battery wire (yellow). The power supply must be connected to the wires via the fuse.

CAUTION

- Install this unit in the console of your vehicle. Do not touch the metal part of this unit during and shortly after the use of the unit. Metal part such as the heat sink and enclosure become hot.

NOTE

- Mounting and wiring this product requires skills and experience. For best safety, leave the mounting and wiring work to professionals.
- Make sure to ground the unit to a negative 12V DC power supply.
- Do not install the unit in a spot exposed to direct sunlight or excessive heat or humidity. Also avoid places with too much dust or the possibility of water splashing.
- Do not use your own screws. Use only the screws provided. If you use the wrong screws, you could damage the unit.
- If the power is not turned ON ("PROTECT" is displayed), the speaker wire may have a short-circuit or touched the chassis of the vehicle and the protection function may have been activated. Therefore, the speaker wire should be checked.
- If your car's ignition does not have an ACC position, connect the ignition wires to a power source that can be turned on and off with the ignition key. If you connect the ignition wire to a power source with a constant voltage supply, such as with battery wires, the battery may be drained.
- If the console has a lid, make sure to install the unit so that the front panel will not hit the lid when closing and opening.
- If the fuse blows, first make sure the wires aren't touching to cause a short circuit, then replace the old fuse with one with the same rating.

- Insulate unconnected wires with vinyl tape or other similar material. To prevent a short circuit, do not remove the caps on the ends of the unconnected wires or the terminals.
- Connect the speaker wires correctly to the terminals to which they correspond. The unit may be damaged or fail to work if you share the \ominus wires or ground them to any metal part in the car.
- When only two speakers are being connected to the system, connect the connectors either to both the front output terminals or to both the rear output terminals (do not mix front and rear). For example, if you connect the \oplus connector of the left speaker to a front output terminal, do not connect the \ominus connector to a rear output terminal.
- After the unit is installed, check whether the brake lamps, blinkers, wipers, etc. on the car are working properly.
- Mount the unit so that the mounting angle is 30° or less.
- This unit has the cooling fan to decrease the internal temperature. Do not mount the unit in a place where the cooling fan of the unit is blocked. Blocking these openings will inhibit the cooling of the internal temperature and result in malfunction.

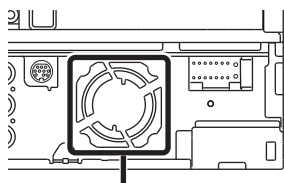

Cooling fan

- Do not press hard on the panel surface when installing the unit to the vehicle. Otherwise scars, damage, or failure may result.
- Reception may drop if there are metal objects near the Bluetooth antenna.



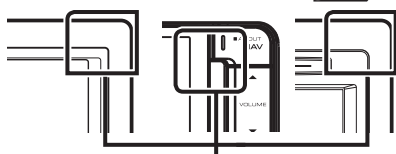



DNX7150DAB DNX715WDAB **DNX4** →

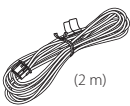

Bluetooth antenna unit

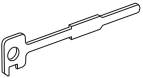
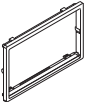
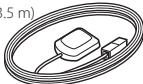
■ Supplied accessories

First of all, make sure that all accessories are supplied with the unit.

①  x1	②  (2 m) x1
③ ^{[1][2]}  x1	④ ^[3]  x2
⑤ ^[3]  x1	⑥  (3.5 m) x1
⑦  x1	⑧  (3 m) x1
⑨ ^[1]  x1	① ^[1] DNX7150DAB only ② ^[2] DNX715WDAB only ③ ^[3] Except DNX715WDAB

■ Unit

- 1) To prevent a short circuit, remove the key from the ignition and disconnect the \ominus terminal of the battery.
- 2) Make the proper input and output wire connections for each unit.
- 3) Connect the wire on the wiring harness.
- 4) Take Connector B on the wiring harness and connect it to the speaker connector in your vehicle.
- 5) Take Connector A on the wiring harness and connect it to the external power connector on your vehicle.
- 6) Connect the wiring harness connector to the unit.
- 7) Install the unit in your car
- 8) Reconnect the \ominus battery.
- 9) Press the <Reset> button. **(P.4)**
- 10) Perform the Initial Setup.

See **First Step (P.6)**.

• **DNX7150DAB, DNX4**

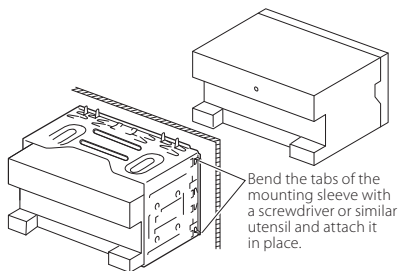

• **DNX715WDAB**

Screw (M5x6mm) (Sold separately)

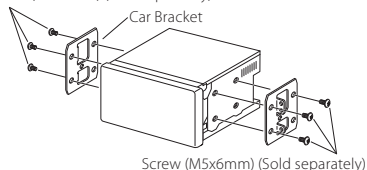

NOTE

- Make sure that the unit is installed securely in place. If the unit is unstable, it may malfunction (eg, the sound may skip).

Trim plate (DNX7150DAB, DNX4)

- 1) Attach accessory ⑤ to the unit.

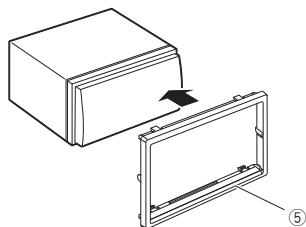

GPS antenna

GPS antenna is installed inside of the car. It should be installed as horizontally as possible to allow easy reception of the GPS satellite signals.

To mount the GPS antenna inside your vehicle:

- 1) Clean your dashboard or other surface.
- 2) Remove the separator of the metal plate (accessory ⑦).
- 3) Press the metal plate (accessory ⑦) down firmly on your dashboard or other mounting surface. You can bend the metal plate (accessory ⑦) to conform to a curved surface, if necessary.
- 4) Remove the separator of the GPS antenna (accessory ⑥), and stick the antenna to the metal plate (accessory ⑦).

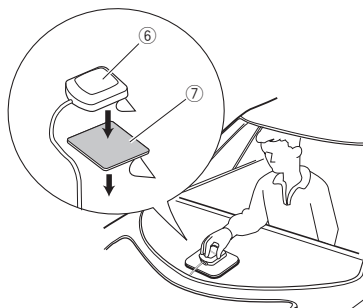

NOTE

- Depending on the type of car, reception of the GPS satellite signals might not be possible with an inside installation.
- The GPS antenna should be installed at a position that is spaced at least 12 inch (30 cm) from cellular phone or other transmitting antennas. Signals from the GPS satellite may be interfered with by these types of communication.
- Painting the GPS antenna with (metallic) paint may cause a drop in performance.

Microphone unit

- 1) Check the installation position of the microphone (accessory ⑧).
- 2) Clean the installation surface.
- 3) Remove the separator of the microphone (accessory ⑧), and stick the microphone to the place shown below.
- 4) Wire the microphone cable up to the unit with it secured at several positions using tape or other desired method.
- 5) Adjust the direction of the microphone (accessory ⑧) to the driver.

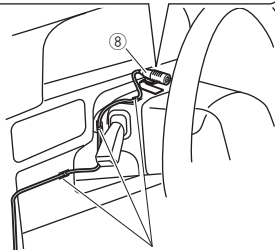
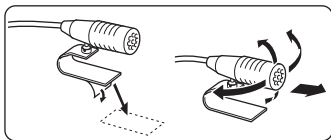

Fix a cable with a commercial item of tape.

Removing the trim plate (DNX7150DAB, DNX4)

- 1) Engage the catch pins on the extraction key (accessory ④) and remove the two locks on the lower level.
Lower the trim plate (accessory ⑤) and pull it forward as shown in the figure.

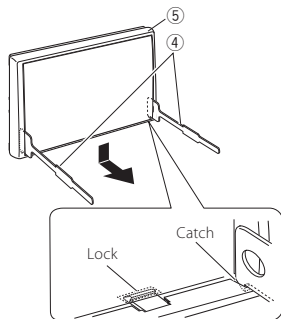

NOTE

- The trim plate can be removed from the top side in the same manner.
- 2) When the lower level is removed, remove the upper two locations.

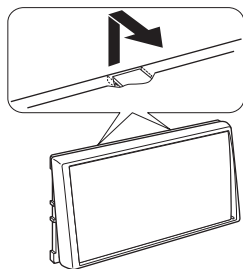

■ Removing the unit (DNX7150DAB, **DNX4**)

- 1) Remove the trim plate by referring to step 1 in "Removing the trim plate".
- 2) Insert the two extraction key (accessory④) deeply into the slots on each side, as shown.

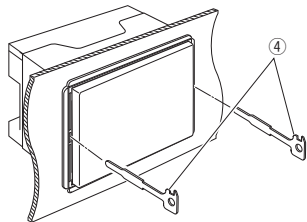

- 3) Lower the extraction key toward the bottom, and pull out the unit halfway while pressing towards the inside.

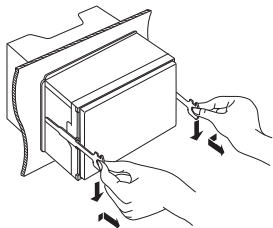

NOTE

- Be careful to avoid injury from the catch pins on the extraction key.
- 4) Pull the unit all the way out with your hands, being careful not to drop it.

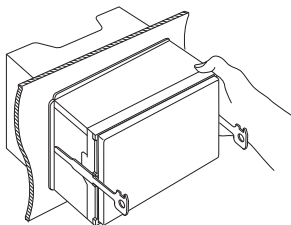

■ Wiring harness (Accessory ①) connector function guide

Pin Numbers for ISO Connectors	Cable Color	Functions
External Power Connector		
A-4	Yellow	Battery
A-5	Blue/White	Power Control
A-6	Orange/White	Dimmer
A-7	Red	Ignition (ACC)
A-8	Black	Earth (Ground) Connection
Speaker Connector		
B-1	Purple	Rear Right (+)
B-2	Purple/Black	Rear Right (-)
B-3	Gray	Front Right (+)
B-4	Gray/Black	Front Right (-)
B-5	White	Front Left (+)
B-6	White/Black	Front Left (-)
B-7	Green	Rear Left (+)
B-8	Green/Black	Rear Left (-)

*Speaker Impedance: 4-8 Ω

System connection

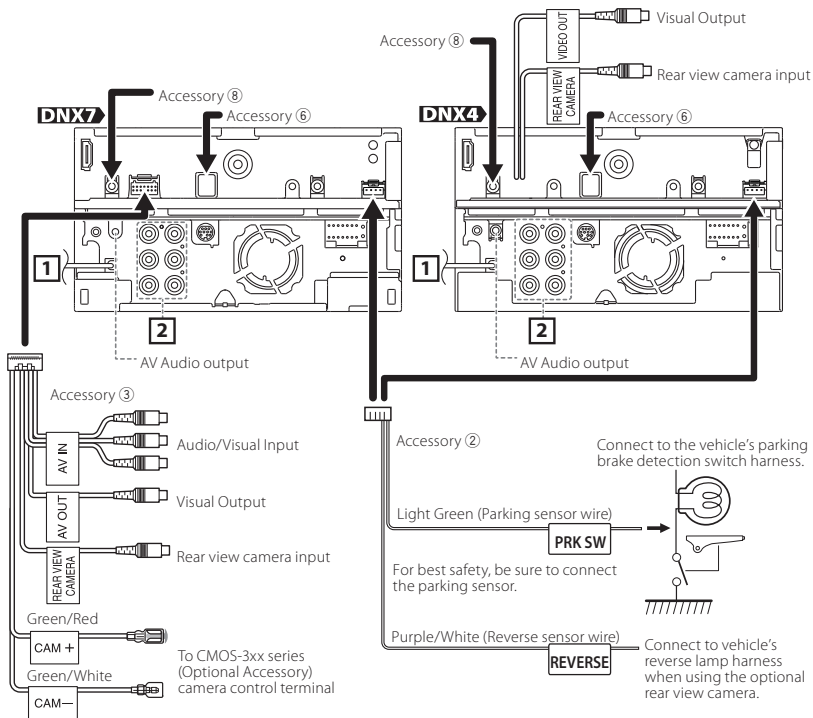

1 FM/AM antenna input

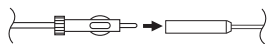

Accessory ⑥: GPS Antenna

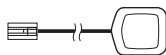

2

- Rear Audio Preout
- Front Audio Preout
- Subwoofer Preout

When connecting to an external amplifier, connect its ground wire to the car's chassis to avoid damaging the unit.

Accessory ⑧: Bluetooth Microphone

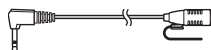

Connecting wires to terminals

DAB antenna CX-DAB1 (Optional accessory)
(DNX7150DAB, DNX715WDAB, DNX4150DAB only)

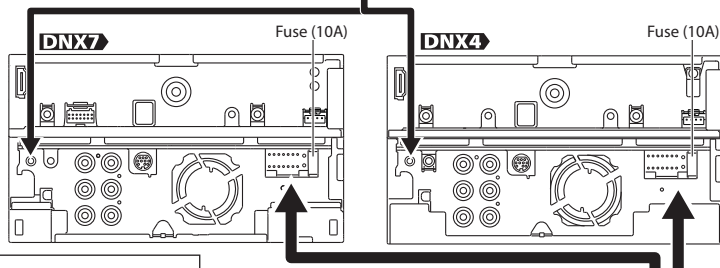

Use of a CX-DAB1 (optional accessory) as a DAB antenna is recommended.

When using a commercially available DAB antenna, the diameter of the SMB connector must be $\Phi 6.5$ mm or less.

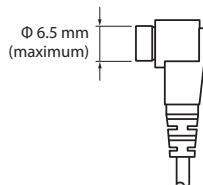

- A: Black (Ground wire)
- B: Yellow (Battery wire)
- C: Red (Ignition wire)

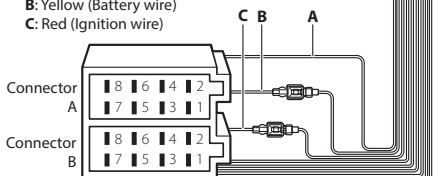

If no connections are made, do not let the wire come out from the tab.

Connect either to the power control terminal when using the optional power amplifier, or to the power terminal for the booster amplifier of the film-type or short pole type antenna.

Connect to the terminal that is grounded when either the telephone rings or during conversation.

To use the steering wheel remote control feature, an exclusive remote adapter (not supplied) that matches your car is required.

Blue/White (Power control/
Antenna control wire)

P.CONT ANT.CONT

Brown (Mute control wire)

MUTE

Light Blue/Yellow (Steering remote
control wire)

REMOTE CONT STEERING WHEEL REMOTE CONTROL

WARNING for Connecting the ISO Connector

The pin arrangement for the ISO connectors depends on the type of vehicle you drive. Make sure to make the proper connections to prevent damage to the unit. The default connection for the wiring harness is described in (1) below. If the ISO connector pins are set as described in (2), make the connection as illustrated. Please be sure to reconnect the cable as shown (2) below to install this unit to the **Volkswagen** vehicles etc.

(1): Default setting

The red (A-7 pin) of the vehicle's ISO connector is linked with the ignition, and the yellow (A-4 pin) is connected to the constant power supply.

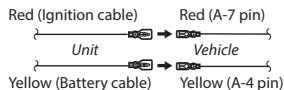

(2)

The red (A-7 pin) of the vehicle's ISO connector is connected to the constant power supply, and the yellow (A-4 pin) is linked to the ignition.

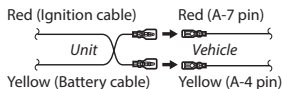

Optional accessory connection

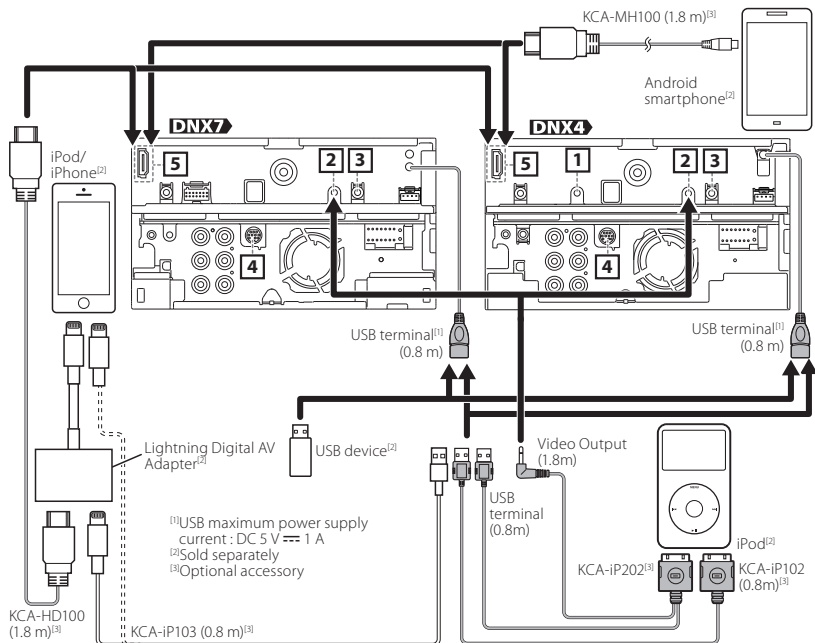

- 1** AV-IN (CA-C3AV; Optional Accessory) input
- 2** iPod/ AV-IN2 (CA-C3AV; Optional Accessory) input (iPod/ AV-IN2 switchable)
- 3** TV tuner remote output (DNX7, DNX4150DAB, DNX4150BT only)
- 4** External I/F
Maximum power supply current : 12 V $\overline{\overline{=}}$ 500 mA

- 5** MHL maximum power supply current : 5 V $\overline{\overline{=}}$ 900 mA
When you connect the cable to HDMI/MHL terminal, remove the fixture. After connecting the cable, put the fixture again.

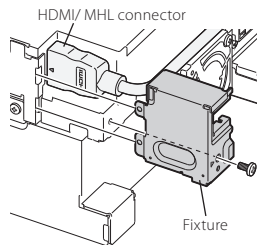

NOTE

- When you connect iPod/iPhone with HDMI cable, the necessary cable differs depending on the type of the connector like Lightning or 30-pin. Refer to "iPod/iPhone connection" (P.28) for the necessary cable.
- The setting is necessary to meet the connected iPod/iPhone or Android device.
- It is also possible to connect with iPod/iPhone or Android device via Bluetooth. Refer to "iPod/iPhone connection" (P.28) or "Android connection" (P.28).

About this Unit

■ Copyrights

- The Bluetooth word mark and logos are owned by the Bluetooth SIG, Inc. and any use of such marks by JVC KENWOOD Corporation is under license. Other trademarks and trade names are those of their respective owners.
- The "AAC" logo is a trademark of Dolby Laboratories.
- "Made for iPod" and "Made for iPhone" mean that an electronic accessory has been designed to connect specifically to iPod or iPhone, respectively, and has been certified by the developer to meet Apple performance standards.
Apple is not responsible for the operation of this device or its compliance with safety and regulatory standards. Please note that the use of this accessory with iPod or iPhone may affect wireless performance.
- iPhone, iPod, iPod classic, iPod nano, and iPod touch are trademarks of Apple Inc., registered in the U.S. and other countries.
iTunes is a trademark of Apple Inc.
Lightning is a trademark of Apple Inc.
-  is a trademark of DVD Format/Logo Licensing Corporation registered in the U.S., Japan and other countries.
- This item incorporates copy protection technology that is protected by U.S. patents and other intellectual property rights of Rovi Corporation. Reverse engineering and disassembly are prohibited.
- Manufactured under license from Dolby Laboratories.
Dolby and the double-D symbol are trademarks of Dolby Laboratories.
- Android is a trademark of Google Inc.
- Adobe, Acrobat and Reader are either registered trademarks or trademarks of Adobe Systems Incorporated in the United States and/or other countries.
- SDHC and microSDHC Logos are trademarks of SD-3C, LLC.
- DivX
This DivX Certified® device has passed rigorous testing to ensure it plays DivX® video.
To play purchased DivX movies, first register your device at vod.divx.com. Find your registration code in the DivX VOD section of your device setup menu.

See **DivX(R) VOD (P.53)**.

- DivX Certified® to play DivX® video, including premium content.
- DivX®, DivX Certified® and associated logos are trademarks of DivX, LLC and are used under license.
- The terms HDMI and HDMI High-Definition Multimedia Interface, and the HDMI logo are trademarks or registered trademarks of HDMI Licensing LLC in the United States and other countries.
- MHL and the MHL logo are a trademark or registered trademark of MHL, LLC.
- Incorporates MHL 2
- "aupeo" is a trade mark of Aupeo GmbH.
- INRIX is a registered trademark of INRIX, Inc.
- THIS PRODUCT IS LICENSED UNDER THE AVC PATENT PORTFOLIO LICENSE FOR THE PERSONAL USE OF A CONSUMER OR OTHER USES IN WHICH IT DOES NOT RECEIVE REMUNERATION TO (i) ENCODE VIDEO IN COMPLIANCE WITH THE AVC STANDARD ("AVC VIDEO") AND/OR (ii) DECODE AVC VIDEO THAT WAS ENCODED BY A CONSUMER ENGAGED IN A PERSONAL ACTIVITY AND/OR WAS OBTAINED FROM A VIDEO PROVIDER LICENSED TO PROVIDE AVC VIDEO. NO LICENSE IS GRANTED OR SHALL BE IMPLIED FOR ANY OTHER USE. ADDITIONAL INFORMATION MAY BE OBTAINED FROM MPEG LA, L.L.C. SEE [HTTP://WWW.MPEGLA.COM](http://www.mpegla.com)
- THIS PRODUCT IS LICENSED UNDER THE MPEG-4 VISUAL PATENT PORTFOLIO LICENSE FOR THE PERSONAL AND NON-COMMERCIAL USE OF A CONSUMER FOR (i) ENCODING VIDEO IN COMPLIANCE WITH THE MPEG-4 VISUAL STANDARD ("MPEG-4 VIDEO") AND/OR (ii) DECODING MPEG-4 VIDEO THAT WAS ENCODED BY A CONSUMER ENGAGED IN A PERSONAL AND NON-COMMERCIAL ACTIVITY AND/OR WAS OBTAINED FROM A VIDEO PROVIDER LICENSED BY MPEG LA TO PROVIDE MPEG-4 VIDEO. NO LICENSE IS GRANTED OR SHALL BE IMPLIED FOR ANY OTHER USE. ADDITIONAL INFORMATION INCLUDING THAT RELATING TO PROMOTIONAL, INTERNAL AND COMMERCIAL USES AND LICENSING MAY BE OBTAINED FROM MPEG LA, LLC. SEE [HTTP://WWW.MPEGLA.COM](http://www.mpegla.com).

- libFLAC

Copyright (C) 2000,2001,2002,2003,2004,2005,2006,2007,2008,2009 Josh Coalson

Redistribution and use in source and binary forms, with or without modification, are permitted

provided that the following conditions are met:

- Redistributions of source code must retain the above copyright notice, this list of conditions and the following disclaimer.

- Redistributions in binary form must reproduce the above copyright notice, this list of conditions and the following disclaimer in the documentation and/or other materials provided with the distribution.

- Neither the name of the Xiph.org Foundation nor the names of its contributors may be used to endorse or promote products derived from this software without specific prior written permission.

THIS SOFTWARE IS PROVIDED BY THE COPYRIGHT HOLDERS AND CONTRIBUTORS "AS IS" AND ANY EXPRESS OR IMPLIED WARRANTIES, INCLUDING, BUT NOT LIMITED TO, THE IMPLIED WARRANTIES OF MERCHANTABILITY AND FITNESS FOR A PARTICULAR PURPOSE ARE DISCLAIMED. IN NO EVENT SHALL THE FOUNDATION OR CONTRIBUTORS BE LIABLE FOR ANY DIRECT, INDIRECT, INCIDENTAL, SPECIAL, EXEMPLARY, OR CONSEQUENTIAL DAMAGES (INCLUDING, BUT NOT LIMITED TO, PROCUREMENT OF SUBSTITUTE GOODS OR SERVICES; LOSS OF USE, DATA, OR PROFITS; OR BUSINESS INTERRUPTION) HOWEVER CAUSED AND ON ANY THEORY OF LIABILITY, WHETHER IN CONTRACT, STRICT LIABILITY, OR TORT (INCLUDING NEGLIGENCE OR OTHERWISE) ARISING IN ANY WAY OUT OF THE USE OF THIS SOFTWARE, EVEN IF ADVISED OF THE POSSIBILITY OF SUCH DAMAGE.

Android connection

To connect the Android device with this unit, the cable (sold separately) and the profile which your Android device supports are necessary as follows:

- To listen to music and watch video of APPS source
 - MHL device
 - KCA-MH100 (Optional Accessory)
 - Bluetooth profile: SPP
- To listen to music of APPS source
 - Bluetooth profile: A2DP
 - Bluetooth profile: SPP
- To listen to music of Bluetooth Audio source
 - Bluetooth profile: A2DP
 - Bluetooth profile: AVRCP

iPod/iPhone connection

To connect the iPod/iPhone with this unit, the cable, adapter (both sold separately), and the profile which your iPod/iPhone supports are necessary as follows:

- To listen music and watch video with Lightning connector device
 - Lightning Digital AV Adapter
 - KCA-HD100
 - KCA-iP103
 - Bluetooth profile: SPP
- To listen music with Lightning connector device
 - KCA-iP103
- To listen music and watch video with 30-pin connector device
 - KCA-iP202
- To listen music with 30-pin connector device
 - KCA-iP102
- To listen to music via Bluetooth
 - Bluetooth profile: A2DP
 - Bluetooth profile: SPP

NOTE

- When connecting with Lightning Digital AV Adapter some applications can be controlled from this unit. The operable functions depend on the application. Refer to "Apps Operation" (P.51) in the Instruction Manual.
- Do not leave the cable or the adapter made by other makers inside the car. It might lead the malfunction caused by heat.

Connectable iPod/iPhone

The following models can be connected to this unit.

Made for

- iPhone 5s
- iPhone 5c
- iPhone 5
- iPhone 4S
- iPhone 4
- iPhone 3GS
- iPhone 3G
- iPhone
- iPod touch (5th generation)
- iPod touch (4th generation)
- iPod touch (3rd generation)
- iPod touch (2nd generation)
- iPod touch (1st generation)
- iPod classic
- iPod with video
- iPod nano (7th generation)
- iPod nano (6th generation)
- iPod nano (5th generation)
- iPod nano (4th generation)
- iPod nano (3rd generation)

Requirements Aha™:

iPhone or iPod touch

- Use an Apple iPhone or iPod touch running iOS4 or later.
- Search for “Aha” in the Apple iTunes App Store to find and install the most current version of the Aha™ application on your device.

Android™

- Use Android OS 2.2 or later.
- Download the Aha™ application to your smartphone from the Android Marketplace.

NOTE

- In the application on your device, log in and create a free account with Aha.
- Internet connection by 3G, EDGE, or WiFi.
- Because Aha™ is a third-party service, the specifications are subject to change without prior notice. Accordingly, compatibility may be impaired or some or all of the services may become unavailable.
- Some Aha™ functionality cannot be operated from this unit.
- aha, the Aha logo, and the Aha trade dress are trademarks or registered trademarks of HARMAN International Industries, used with permission.

About AUPEO!:

iPhone or iPod touch

- Install the latest version of the AUPEO! application on your iPhone or iPod touch. (Search for “AUPEO!” in the Apple iTunes App Store to find and install the most recent version.)

Android™

- Visit Google play and search for “AUPEO!” to install.

NOTE

- Ensure you are logged in to your smartphone application. If you do not have an AUPEO! account, you can create one for free from your smartphone or at www.aupeo.com.
- Because AUPEO! is a third-party service, the specifications are subject to change without prior notice. Accordingly, compatibility may be impaired or some or all of the services may become unavailable.
- Some functions of AUPEO! cannot be operated from this unit.
- For issues using the application, contact AUPEO! at www.aupeo.com.
- An active internet connection.

Information on Disposal of Old Electrical and Electronic Equipment and Batteries (applicable for EU countries that have adopted separate waste collection systems)

Products and batteries with the symbol (crossed-out wheeled bin) cannot be disposed as household waste. Old electrical and electronic equipment and batteries should be recycled at a facility capable of handling these items and their waste byproducts.

Contact your local authority for details in locating a recycle facility nearest to you.

Proper recycling and waste disposal will help conserve resources whilst preventing detrimental effects on our health and the environment.

Notice: The sign "Pb" below the symbol for batteries indicates that this battery contains lead.



The marking of products using lasers

**CLASS 1
LASER PRODUCT**

The label is attached to the chassis/case and says that the component uses laser beams that have been classified as Class 1. It means that the unit is utilizing laser beams that are of a weaker class. There is no danger of hazardous radiation outside the unit.

DNX4150BTR



Дата изготовления (месяц/год)
находится на этикетке устройства.

מידע בדבר השלכה לאשפה של ציוד חשמלי ואלקטרוני ישן וכן סוללות (רלוונטי למדינות שמשמשות במערכת איסוף אשפה מופרדת).

לא ניתן להשליך מוצרים וסוללות עם הסימון (פח אשפה עם X עליו) כאשפה ביתית רגילה.

יש למחזר ציוד חשמלי ואלקטרוני ישן וכן סוללות במתקן המסוגל לטפל בפריטים כאלה ובתוצרי הלוואי שלהם.

צרו קשר עם הרשות המקומית לקבלת פרטים אודות מתקן המיחזור הקרוב אליכם. מיחזור והשלכה לאשפה נאותים יעזרו לשמר משאבים ולמנוע השפעות שליליות על בריאותנו ועל הסביבה.

שימו לב: הסימון Pb שמתחת לסימון עבר סוללות מצוין שהסוללה מכילה עופרת.





Declaration of Conformity with regard to the EMC Directive 2004/108/EC
Declaration of Conformity with regard to the R&TTE Directive 1999/5/EC
Declaration of Conformity with regard to the RoHS Directive 2011/65/EU
Manufacturer:

JVC KENWOOD Corporation
3-12, Moriyacho, Kanagawa-ku, Yokohama-shi, Kanagawa 221-0022, JAPAN

EU Representative:
JVCKENWOOD NEDERLAND B.V.

Amsterdamseweg 37, 1422 AC UITHOORN, The Netherlands

English

Hereby, JVC KENWOOD declares that this unit DNX7150DAB, DNX715WDAB, DNX4150DAB, DNX4150BT, DNX4150BTR is in compliance with the essential requirements and other relevant provisions of Directive 1999/5/EC.

Français

Par la présente JVC KENWOOD déclare que l'appareil DNX7150DAB, DNX715WDAB, DNX4150DAB, DNX4150BT, DNX4150BTR est conforme aux exigences essentielles et aux autres dispositions pertinentes de la directive 1999/5/CE.

Par la présente, JVC KENWOOD déclare que ce DNX7150DAB, DNX715WDAB, DNX4150DAB, DNX4150BT, DNX4150BTR est conforme aux exigences essentielles et aux autres dispositions de la directive 1999/5/CE qui lui sont applicables.

Deutsch

Hiermit erklärt JVC KENWOOD, dass sich dieser DNX7150DAB, DNX715WDAB, DNX4150DAB, DNX4150BT, DNX4150BTR in Übereinstimmung mit den grundlegenden Anforderungen und den anderen relevanten Vorschriften der Richtlinie 1999/5/EG befindet. (BMW)

Hiermit erklärt JVC KENWOOD die Übereinstimmung des Gerätes DNX7150DAB, DNX715WDAB, DNX4150DAB, DNX4150BT, DNX4150BTR mit den grundlegenden Anforderungen und den anderen relevanten Festlegungen der Richtlinie 1999/5/EG. (Wien)

Nederlands

Hierbij verklaart JVC KENWOOD dat het toestel DNX7150DAB, DNX715WDAB, DNX4150DAB, DNX4150BT, DNX4150BTR in overeenstemming is met de essentiële eisen en de andere relevante bepalingen van richtlijn 1999/5/EG.

Bij deze verklaart JVC KENWOOD dat deze DNX7150DAB, DNX715WDAB, DNX4150DAB, DNX4150BT, DNX4150BTR voldoet aan de essentiële eisen en aan de overige relevante bepalingen van Richtlijn 1999/5/EC.

Italiano

Con la presente JVC KENWOOD dichiara che questo DNX7150DAB, DNX715WDAB, DNX4150DAB, DNX4150BT, DNX4150BTR è conforme ai requisiti essenziali ed alle altre disposizioni pertinenti stabilite dalla direttiva 1999/5/CE.

Español

Por medio de la presente JVC KENWOOD declara que el DNX7150DAB, DNX715WDAB, DNX4150DAB, DNX4150BT, DNX4150BTR cumple con los requisitos esenciales y cualesquiera otras disposiciones aplicables o exigibles de la Directiva 1999/5/CE.

Português

JVC KENWOOD declara que este DNX7150DAB, DNX715WDAB, DNX4150DAB, DNX4150BT, DNX4150BTR está conforme com os requisitos essenciais e outras disposições da Directiva 1999/5/CE.

Polska

JVC KENWOOD niniejszym oświadcza, że DNX7150DAB, DNX715WDAB, DNX4150DAB, DNX4150BT, DNX4150BTR spełnia zasadnicze wymagania oraz inne istotne postanowienia dyrektywy 1999/5/EC.

Český

JVC KENWOOD tímto prohlašuje, že DNX7150DAB, DNX715WDAB, DNX4150DAB, DNX4150BT, DNX4150BTR je ve shodě se základními požadavky a s dalšími příslušnými ustanoveními Nařízení vlády č. 426/2000 Sb.

Magyar

Alulírott, JVC KENWOOD, kijelenti, hogy a jelen DNX7150DAB, DNX715WDAB, DNX4150DAB, DNX4150BT, DNX4150BTR megfelel az 1999/5/EC irányelvben meghatározott alapvető követelményeknek és egyéb vonatkozó előírásoknak.

Croatia

Ovim putem tvrtka JVC KENWOOD izjavljuje da je ovaj uređaj DNX7150DAB, DNX715WDAB, DNX4150DAB, DNX4150BT, DNX4150BTR u skladu s osnovnim zahtjevima i ostalim ustrežnim predpisima Direktive 1999/5/EC.

Svenska

Härmed intygar JVC KENWOOD att denna DNX7150DAB, DNX715WDAB, DNX4150DAB, DNX4150BT, DNX4150BTR står i överensstämmelse med de väsentliga egenskapskrav och övriga relevanta bestämmelser som framgår av direktiv 1999/5/EG.

Suomi

JVC KENWOOD vakuuttaa täten että DNX7150DAB, DNX715WDAB, DNX4150DAB, DNX4150BT, DNX4150BTR tyypillinen laite on direktiivin 1999/5/EY oleellisten vaatimusten ja sitä koskevien direktiivin muiden ehtojen mukainen.

Slovensko

S tem JVC KENWOOD izjavlja, da je ta DNX7150DAB, DNX715WDAB, DNX4150DAB, DNX4150BT, DNX4150BTR v skladu z osnovnimi zahtevami in ostalimi ustreznimi predpisi Direktive 1999/5/EC.

Slovensky

Spoločnosť JVC KENWOOD týmto vyhlasuje, že DNX7150DAB, DNX715WDAB, DNX4150DAB, DNX4150BT, DNX4150BTR spĺňa základné požiadavky a ďalšie príslušné ustanovenia Direktívy 1999/5/EC.

Dansk

Undertegnede JVC KENWOOD erklærer herved, at følgende udstyr DNX7150DAB, DNX715WDAB, DNX4150DAB, DNX4150BT, DNX4150BTR overholder de væsentlige krav og øvrige relevante krav i direktiv 1999/5/EF.

Norsk

JVC KENWOOD erklærer herved at enheten DNX7150DAB, DNX715WDAB, DNX4150DAB, DNX4150BT, DNX4150BTR oppfyller grunnleggende krav og andre bestemmelser i direktiv 1999/5/EF.

Ελληνικά

ΜΕ ΤΗΝ ΠΑΡΟΥΣΑ JVC KENWOOD ΔΗΛΩΝΕΙ ΟΤΙ DNX7150DAB, DNX715WDAB, DNX4150DAB, DNX4150BT, DNX4150BTR ΣΥΜΜΟΡΦΟΝΕΤΑΙ ΠΡΟΣ ΤΙΣ ΟΥΣΙΩΔΕΙΣ ΑΠΑΙΤΗΣΕΙΣ ΚΑΙ ΤΙΣ ΛΟΙΠΕΣ ΣΧΕΤΙΚΕΣ ΔΙΑΤΑΞΕΙΣ ΤΗΣ ΟΔΗΓΙΑΣ 1999/5/ΕΚ.

Eesti

Sellega kinnitab JVC KENWOOD, et see DNX7150DAB, DNX715WDAB, DNX4150DAB, DNX4150BT, DNX4150BTR vastab direktiivi 1999/5/EC põhilistele nõudmistele ja muudele asjakohastele määrustele.

Latviešu

Ar šo, JVC KENWOOD, apstiprina, ka DNX7150DAB, DNX715WDAB, DNX4150DAB, DNX4150BT, DNX4150BTR atbilst Direktīvas 1999/5/EK galvenajām prasībām un citiem tās nosacījumiem.

Lietuviškai

Šiuo, JVC KENWOOD, pareiškia, kad šis DNX7150DAB, DNX715WDAB, DNX4150DAB, DNX4150BT, DNX4150BTR atitinka pagrindinius Direktyvos 1999/5/EB reikalavimus ir kitas svarbias nuostatas.

Malti

Hawnhekk, JVC KENWOOD, jiddikjara li dan DNX7150DAB, DNX715WDAB, DNX4150DAB, DNX4150BT, DNX4150BTR jikkonforma mal-ħitijiet essenenzjali u ma provvedimenti oħrajn relevanti li hemm fid-Dirrettiva 1999/5/EC.

Українська

Компанія JVC KENWOOD заявляє, що цей виріб DNX7150DAB, DNX715WDAB, DNX4150DAB, DNX4150BT, DNX4150BTR відповідає ключовим вимогам та іншим пов'язаним положенням Директиви 1999/5/EC.

Türkçe

Bu vesileyle JVC Kenwood, DNX7150DAB, DNX715WDAB, DNX4150DAB, DNX4150BT, DNX4150BTR ünitesinin, 1999/5/EC Direktifinin başlıca gereksinimleri ve diğer ilgili hükümleri ile uyumlu olduğunu beyan eder.

HDMI™
HIGH-DEFINITION MULTIMEDIA INTERFACE

MHL™
Mobile High-Definition Link

DAB+
Digital Audio Broadcasting

aha™

Bluetooth®

DOLBY DIGITAL

DIVX™

**SD
HG™**

**micro
SD
HG™**

AUPEO!®
PERSONAL RADIO

Made for
 iPod  iPhone

Designed for
 Windows
Media™



**DVD
VIDEO™**

KENWOOD