

KENWOOD

INSTRUCTION MANUAL



VHF DIGITAL TRANSCEIVER
TK-D200G/ TK-D200

UHF DIGITAL TRANSCEIVER
TK-D300G/ TK-D300

Mobile User Guide

When you are outside, refer to the "Mobile User Guide". Mobile User Guide can be viewed with standard browser for Android tablet and iPhone.



■ <http://manual2.jvckenwood.com/com/mobile/global/>

JVCKENWOOD Corporation

© B5A-0004-00 (E, E2)
09 08 07 06 05 04 03 02 01 00

THANK YOU

We are grateful you have chosen **KENWOOD** for your DMR (Digital Mobile Radio) applications.

This instruction manual covers only the basic operations of your DMR (Digital Mobile Radio). Ask your dealer for information on any customized features they may have added to your radio.

NOTICES TO THE USER

- ◆ Government law prohibits the operation of unlicensed radio transmitters within the territories under government control.
- ◆ Illegal operation is punishable by fine and/or imprisonment.
- ◆ Refer service to qualified technicians only.

Safety: It is important that the operator is aware of, and understands, hazards common to the operation of any transceiver.

Information on Disposal of Old Electrical and Electronic Equipment and Batteries (applicable for countries that have adopted separate waste collection systems)



Products and batteries with the symbol (crossed-out wheeled bin) cannot be disposed as household waste.

Old electrical and electronic equipment and batteries should be recycled at a facility capable of handling these items and their waste byproducts. Contact your local authority for details in locating a recycle facility nearest to you.



Proper recycling and waste disposal will help conserve resources whilst preventing detrimental effects on our health and the environment.

Notice: The sign "Pb" below the symbol for batteries indicates that this battery contains lead.

- QR Code is trademark of Denso Wave Incorporated.
- Android is trademark and/or registered trademark of Google Inc.
- iPhone is trademark of Apple Inc., registered in the U.S. and other countries.

PRECAUTIONS

- Do not charge the transceiver and battery pack when they are wet.
- Ensure that there are no metallic items located between the transceiver and the battery pack.
- Do not use options not specified by **KENWOOD**.
- If the die-cast chassis or other transceiver part is damaged, do not touch the damaged parts.
- If a headset or headphone is connected to the transceiver, reduce the transceiver volume. Pay attention to the volume level when turning the squelch off.
- Do not place the microphone cable around your neck while near machinery that may catch the cable.
- Do not place the transceiver on unstable surfaces.
- Ensure that the end of the antenna does not touch your eyes.
- When the transceiver is used for transmission for many hours, the radiator and chassis will become hot. Do not touch these locations when replacing the battery pack.
- Do not immerse the transceiver in water.
- Always switch the transceiver power off before installing optional accessories.
- The charger is the device that disconnects the unit from the AC mains line. The AC plug should be readily accessible.



WARNING

Turn the transceiver power off in the following locations:

- In explosive atmospheres (flammable gas, dust particles, metallic powders, grain powders, etc.).
- While taking on fuel or while parked at gasoline service stations.
- Near explosives or blasting sites.
- In aircraft. (Any use of the transceiver must follow the instructions and regulations provided by the airline crew.)
- Where restrictions or warnings are posted regarding the use of radio devices, including but not limited to medical facilities.
- Near persons using pacemakers.

**CAUTION**

- Do not disassemble or modify the transceiver for any reason.
- Do not place the transceiver on or near airbag equipment while the vehicle is running. When the airbag inflates, the transceiver may be ejected and strike the driver or passengers.
- Do not transmit while touching the antenna terminal or if any metallic parts are exposed from the antenna covering. Transmitting at such a time may result in a high-frequency burn.
- If an abnormal odor or smoke is detected coming from the transceiver, switch the transceiver power off immediately, remove the battery pack from the transceiver, and contact your **KENWOOD** dealer.
- Use of the transceiver while you are driving may be against traffic laws. Please check and observe the vehicle regulations in your area.
- Do not expose the transceiver to extremely hot or cold conditions.
- Do not carry the battery pack with metal objects, as they may short the battery terminals.
- Danger of explosion if the battery is incorrectly replaced; replace only with the same type.
- When attaching a commercial strap to the transceiver, ensure that the strap is durable. In addition, do not swing the transceiver around by the strap; you may inadvertently strike and injure another person with the transceiver.
- When operating the transceiver in areas where the air is dry, it is easy to build up an electric charge (static electricity). When using an earphone accessory in such conditions, it is possible for the transceiver to send an electric shock through the earphone and to your ear. We recommend you use only a speaker/microphone in these conditions, to avoid electric shocks.

Information concerning the battery pack:

The battery pack includes flammable objects such as organic solvent. Mishandling may cause the battery to rupture producing flames or extreme heat, deteriorate, or cause other forms of damage to the battery. Please observe the following prohibitive matters.



DANGER

- **Do not disassemble or reconstruct the battery!**

The battery pack has a safety function and protection circuit to avoid danger. If they suffer serious damage, the battery may generate heat or smoke, rupture, or burst into flame.

- **Do not short-circuit the battery!**

Do not join the + and – terminals using any form of metal (such as a paper clip or wire). Do not carry or store the battery pack in containers holding metal objects (such as wires, chain-necklaces or hairpins). If the battery pack is short-circuited, excessive current will flow and the battery may generate heat or smoke, rupture, or burst into flame. It will also cause metal objects to heat up.

- **Do not incinerate or apply heat to the battery!**

If the insulator is melted, the gas release vent or safety function is damaged, or the electrolyte is ignited, the battery may generate heat or smoke, rupture, or burst into flame.

- **Do not leave the battery near fire, stoves, or other heat generators (areas reaching over 80°C/ 176°F)!**

If the polymer separator is melted due to high temperature, an internal short-circuit may occur in the individual cells and the battery may generate heat or smoke, rupture, or burst into flame.

- **Avoid immersing the battery in water or getting it wet by other means!**

If the battery becomes wet, wipe it off with a dry towel before use. If the battery's protection circuit is damaged, the battery may charge at extreme current (or voltage) and an abnormal chemical reaction may occur. The battery may generate heat or smoke, rupture, or burst into flame.

**DANGER**

- **Do not charge the battery near fire or under direct sunlight!**
If the battery's protection circuit is damaged, the battery may charge at extreme current (or voltage) and an abnormal chemical reaction may occur. The battery may generate heat or smoke, rupture, or burst into flame.
- **Use only the specified charger and observe charging requirements!**
If the battery is charged in unspecified conditions (under high temperature over the regulated value, excessive high voltage or current over regulated value, or with a remodeled charger), it may overcharge or an abnormal chemical reaction may occur. The battery may generate heat or smoke, rupture, or burst into flame.
- **Do not pierce the battery with any object, strike it with an instrument, or step on it!**
This may break or deform the battery, causing a short-circuit. The battery may generate heat or smoke, rupture, or burst into flame.
- **Do not jar or throw the battery!**
An impact may cause the battery to leak, generate heat or smoke, rupture, and/or burst into flame. If the battery's protection circuit is damaged, the battery may charge at an abnormal current (or voltage), and an abnormal chemical reaction may occur. The battery may generate heat or smoke, rupture, or burst into flame.
- **Do not use the battery pack if it is damaged in any way!**
The battery may generate heat or smoke, rupture, or burst into flame.
- **Do not solder directly onto the battery!**
If the insulator is melted or the gas release vent or safety function is damaged, the battery may generate heat or smoke, rupture, or burst into flame.
- **Do not reverse the battery polarity (and terminals)!**
When charging a reversed battery, an abnormal chemical reaction may occur. In some cases, an unexpected large amount of current may flow upon discharging. The battery may generate heat or smoke, rupture, or burst into flame.

**DANGER**

- **Do not reverse-charge or reverse-connect the battery!**
The battery pack has positive and negative poles. If the battery pack does not smoothly connect with a charger or operating equipment, do not force it; check the polarity of the battery. If the battery pack is reverse-connected to the charger, it will be reverse-charged and an abnormal chemical reaction may occur. The battery may generate heat or smoke, rupture, or burst into flame.
- **Do not touch a ruptured and leaking battery!**
If the electrolyte liquid from the battery gets into your eyes, wash your eyes with fresh water as soon as possible, without rubbing your eyes. Go to the hospital immediately. If left untreated, it may cause eye-problems.

**WARNING**

- **Do not charge the battery for longer than the specified time!**
If the battery pack has not finished charging even after the regulated time has passed, stop it. The battery may generate heat or smoke, rupture, or burst into flame.
- **Do not place the battery pack into a microwave or high pressure container!**
The battery may generate heat or smoke, rupture, or burst into flame.
- **Keep ruptured and leaking battery packs away from fire!**
If the battery pack is leaking (or the battery emits a bad odor), immediately remove it from flammable areas. Electrolyte leaking from battery can easily catch on fire and may cause the battery to generate smoke or burst into flame.
- **Do not use an abnormal battery!**
If the battery pack emits a bad odor, appears to have different coloring, is deformed, or seems abnormal for any other reason, remove it from the charger or operating equipment and do not use it. The battery may generate heat or smoke, rupture, or burst into flame.

CONTENTS

UNPACKING AND CHECKING EQUIPMENT	1
PREPARATION	2
ORIENTATION	6
PROGRAMMABLE FUNCTIONS.....	10
BASIC OPERATIONS	17
MENU MODE (TYPE I ONLY).....	20
ADVANCED OPERATIONS	24
BACKGROUND OPERATIONS	28

UNPACKING AND CHECKING EQUIPMENT

Note: These unpacking instructions are for use by your **KENWOOD** dealer, an authorized **KENWOOD** service facility, or the factory.

Carefully unpack the transceiver. If any items are missing or damaged, file a claim with the carrier immediately.

SUPPLIED ACCESSORIES

Belt clip (KBH-10)	1
• Screws for belt clip (M3 x 6 mm)	2
Universal connector cap	1
• Dressing screw (preassembled).....	1
• Packing (preassembled)	1
Instruction manual	1

PREPARATION

INSTALLING/ REMOVING THE (OPTIONAL) BATTERY PACK

- 1 Match the guides of the battery pack with the grooves on the upper rear of the transceiver, then firmly press the battery pack in place.
- 2 Lock the safety catch to prevent accidentally releasing the battery pack.
- 3 To remove the battery pack, lift the safety catch, press the release latch, then pull the battery pack away from the transceiver.

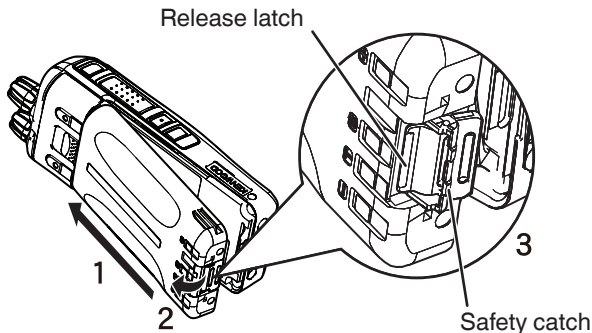

Note:

- ◆ For battery pack charging procedures and usage, refer to the battery charger Instruction Manual.
 - ◆ The battery pack is not charged at the factory; charge it before use.
 - ◆ Before charging a battery pack that is attached to the transceiver, ensure that the safety catch is firmly closed.
 - ◆ Install the battery pack after cleaning the battery pack contacts and the transceiver terminals.
-

INSTALLING THE (OPTIONAL) ANTENNA

Screw the antenna into the connector on the top of the transceiver by holding the antenna at its base and turning it clockwise until secure.

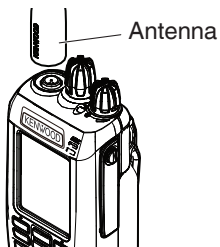

Note: Determine your positioning at a wide open location. When there is bad reception from the GPS satellite, pinpointing may take a while and location errors may occur.

INSTALLING THE BELT CLIP

Using the 2 screws (M3 x 6 mm), affix the supplied belt clip (KBH-10) in place.

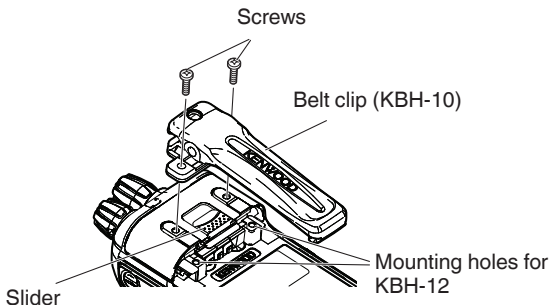

- When attaching the optional KBH-12 belt clip, use the mounting holes on the chassis for the KBH-12. (To attach the KBH-12, move the Slider forward.)

Note: If the belt clip is not installed, its mounting location may get hot during continuous transmission or when left sitting in a hot environment.



CAUTION

Do not use glue which is designed to prevent screw loosening when installing the belt clip, as it may cause damage to the transceiver. Acrylic ester, which is contained in these glues, may crack the transceiver's back panel.

INSTALLING THE CAP OVER THE UNIVERSAL CONNECTOR

Insert the cap into place over the universal connector and secure it in place using the attached screw.

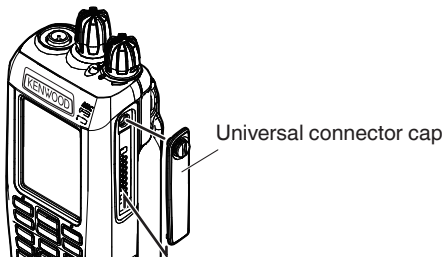

INSTALLING THE (OPTIONAL) SPEAKER/ MICROPHONE OR HEADSET

- 1 Insert the guide of the speaker/ microphone or headset connector into place over the universal connector.
- 2 Secure the connector in place using the attached screw.

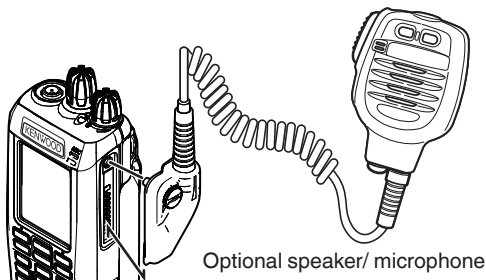

Note: When not using an optional speaker/ microphone or headset, install the cap over the universal connector.

ORIENTATION

There are 2 types of transceivers available:

Type I: Equipped with a display and full keypad.

Type II: Basic model.





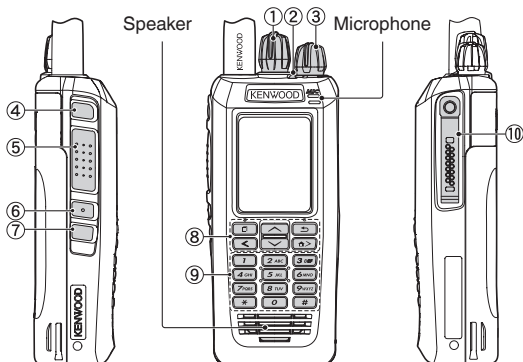



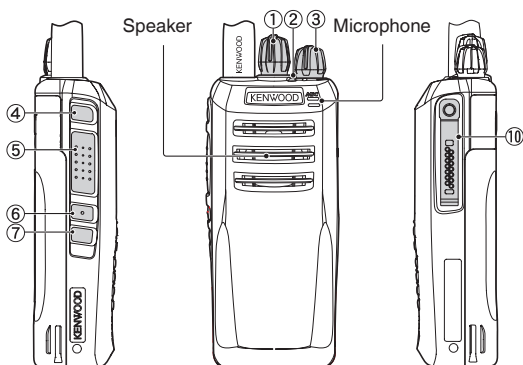



KEYS AND KNOBS

TYPE I



TYPE II













- ① **Selector knob**
Rotate to select a zone or channel (default).
- ② **Transmit/ Receive/ Battery low indicator**
If enabled by your dealer, lights red while transmitting and green while receiving a call. Blinks orange while receiving an Individual or Group call and blinks red when the battery power is low while transmitting
- ③ **Power switch/ Volume control**
Rotate to turn the transceiver On/Off and to adjust the volume.
- ④ **Auxiliary (orange) key**
Press to activate its programmable function. {p 10}
- ⑤ **PTT (Push-To-Talk) switch**
Press and hold this switch, then speak into the microphone to call a station.
- ⑥ **Side 1 key**
Press to activate its programmable function. {p 10} The default is [**Squelch Off Momentary**].
- ⑦ **Side 2 key**
Press to activate its programmable function. {p 10} The default is [**LCD Brightness**] (Type I) or [**None**] (Type II).
- ⑧ , , , , ,  **keys (Type I only)**
Press to activate their programmable functions. {p 10}
 key: The default setting is [**Menu**].
 key: The default setting is [**None**].
 key: The default setting is [**None**].
 key: The default setting is [**None**].
 key: The default setting is [**Zone Up**].
 key: The default setting is [**Zone Down**].
- ⑨ **Keypad (Type I only)**
These keys can also be programmed with secondary functions {p 10} if a programmable function key is programmed as “Function”.
- ⑩ **Universal connector**
Connect a speaker/ microphone or headset here. {p 5}
Otherwise, keep the supplied cap in place.

DISPLAY (TYPE I ONLY)



Indicator	Description
	Signal strength indicator. {p 28}
	Battery power indicator. {p 28}
	The Monitor or Squelch Off function is activated.
	The current Zone (left side icon) or Channel (right side icon) is added to scan.
	Scan is in progress. Blinks while scan is paused.
	A message is stored in memory. Blinks when a new message has arrived.
	The Talk Around function is activated.
	The Scrambler function is activated.
	The channel is using high transmit power.
	The channel is using low transmit power.
	Appears when the GPS position is determined.
	The Lone Worker function is activated.

Indicator	Description
	The Activity Detection function is activated.
	The Broadcast Call function is activated.
	The Key Lock function is activated.
	The OVCM (Open Voice Channel Mode) function is activated.
	Text input mode for capital letters.
	Text input mode for lower case letters.
	Text input mode for numbers.
	Displays the key functions (key guide) for  ,  , and  .

PROGRAMMABLE FUNCTIONS

Following is a list of available programmable functions. Please contact your dealer for further details on those functions which have been programmed on your transceiver.

Note:

- ◆ The listed name in < > brackets is the Key Guide Display default value. Your dealer can change the display.
 - ◆ The listed programmable functions may change or additional functions may be added.
-

■ None

No function has been programmed.

■ Activity Detection <ACT_DT>

Toggles Activity Detection on and off.

■ Activity Reset <ACT_RS>

Resets and begins counting down the timer for the Man-down Delay Time, Stationary Delay Time, and Motion Delay Time.

■ Broadcast <B.CAST>

Toggles the call type between Broadcast Call and Conference Call. You can also use this key to make a Broadcast Group Call.

■ Call 1 ~ 6 <CALL >

Initiates a call on the selected channel.

■ Call Interruption

Interrupts a call, stopping it from being received.

■ Channel Down <CH ▼>

Decreases the Channel number in steps of 1.

- **Channel Down (Continuous) <CH ▼>**
Hold down this key to continuously decrease the Channel number.
- **Channel Entry <CH_ENT>**
Selects the channel number.
- **Channel Up <CH ▲>**
Increases the Channel number in steps of 1.
- **Channel Up (Continuous) <CH ▲>**
Hold down this key to continuously increase the Channel number.
- **Contact List <CNTCT> (Type I Only)**
Places the transceiver in Contact List mode, allowing you to select a contact to perform a Group Call, Individual Call, transmission of a message, transmission of a status, or display/edit the contact details.
- **Digit 1x Up (Type I Only)**
The 5-tone Selcall Code increases by 1.
- **Digit 1x Down (Type I Only)**
The 5-tone Selcall Code decreases by 1.
- **Digit 10x Up (Type I Only)**
The 5-tone Selcall Code increases by 10.
- **Digit 10x Down (Type I Only)**
The 5-tone Selcall Code decreases by 10.
- **Display Format <DISP> (Type I Only)**
Toggles the display between the zone-channel number and the channel name.

■ **Emergency**

Places the transceiver into Emergency mode. Emergency mode is used to carry out emergency actions.

Note: This function can be programmed only on the Auxiliary (orange) key and the optional speaker/microphone PF1 (orange) key.

■ **Fixed Volume <FX_VOL>**

Cycles the various tone levels of the transceiver between low, high, and off.

■ **Function <FNC>**

Press this key, then press a programmable key to activate its secondary function.

■ **GPS Position Display <GPS> (Type I Only)**

Displays your location data.

■ **Home Channel <HOME>**

Press this key to immediately select your home zone and channel (pre-programmed by your dealer).

■ **Home Channel Select <HOME>**

Hold down this key to set the current zone and channel as the Home Channel.

■ **Key Lock <K_LOCK>**

Locks the transceiver keys.

■ **LCD Brightness <BRIGHT> (Type I Only)**

Adjusts the brightness of the transceiver display.

■ **Lone Worker <LN WKR>**

Toggles Lone Worker mode on and off.

■ **Low Transmit Power <LOW>**

Changes the output power to low when using a channel programmed with high power. Press this key again to return to high power.

■ **Maintenance <MAINT> (Type I Only)**

Places the transceiver in Maintenance Display mode.

■ **Menu <MENU> (Type I Only)**

Places the transceiver in Menu mode.

■ **Message <MESSAG> (Type I Only)**

Places the transceiver in Message mode, allowing you to confirm/reply to a received message, edit a message, transmit a short message, and confirm/transmit a message/drafted message.

■ **Monitor <MONI>**

Turns the transceiver signaling off, to listen to all calls that are received on the channel. Press this key again to turn the transceiver signaling back on.

■ **Monitor Momentary <MONI>**

Turns the transceiver signaling off while holding down this key. Release this key to turn the transceiver signaling back on. While signaling is off, you can listen to all calls that are received on the channel.

■ **OVCM <OVCM>**

Toggles OVCM (Open Voice Channel Mode) between on and off.

■ **Receive Entry (Type I Only)**

Places the transceiver in Receive Entry mode, allowing you to enter or change the 5-tone Receive Code.

■ Remote Control

Places the transceiver in Remote Control mode, allowing you to enter a transceiver ID and send commands to that transceiver.

■ Scan <SCAN>

Press this key to start scanning the transceiver channels.

■ Scan Delete/Add <D/A>

Adds or removes the selected Channel to or from the scan sequence.

■ Scrambler <SCR>

Toggles the Scrambler function on and off. Hold this key to enter Scrambler Code mode, to change the Privacy List number. Hold the key again exit Scrambler Code mode. Additionally, the Privacy List becomes the Scrambler List.

Note: This function cannot be used in certain countries. Contact your **KENWOOD** dealer for further information.

■ Selcall <SELCAL>

Places the transceiver in Selcall mode. For 5-tone, Selcall mode allows you to choose a Selcall list or enter a code.

■ Selcall + Status <SEL+ST>

Places the transceiver in Selcall mode. While in Selcall mode, press PF1 or  to enter Status mode. For 5-tone, Selcall mode allows you to choose a Selcall list or enter a code, and Status mode allows you to choose a Status list or enter a code.

■ Send the GPS Data <GPS_TX>

Manually sends your GPS data to the base station.

■ **Speaker Attenuation**

Temporarily reduces the volume level of the speaker/microphone. Only the speaker/microphone PF1 and PF2 keys can be programmed with this function.

■ **Squelch Level <SQL>**

Adjusts the transceiver squelch level.

■ **Squelch Off <SQ_OFF>**

Press to hear background noise. Press this key again to return to normal operation.

■ **Squelch Off Momentary <SQ_OFF>**

Hold down this key to hear background noise. Release this key to return to normal operation.

■ **Stack <STACK> (Type I Only)**

Places the transceiver in Stack mode.

■ **Status <STATUS> (Type I Only)**

Places the transceiver in Status mode. For DMR, Status mode allows you to choose a Status list or input a Status and transmit a message. For 5-tone, Status mode allows you to choose a Status list or enter a code.

■ **Talk Around <TA>**

Toggle Talk Around on and off. Talk Around allows you to communicate directly with other transceivers, without the use of a repeater.

■ **Transceiver Password <PASSWD> (Type I Only)**

Press to enter Transceiver Password mode. While in Transceiver Password mode, the transceiver will remain locked until the correct password is entered.

■ **Zone Delete/Add <ZN_D/A>**

Toggles the Zone status between deleted and added.

■ **Zone Down <ZONE ▼>**

Decreases the zone number in steps of 1.

■ **Zone Down (Continuous) <ZONE ▼>**

Hold down this key to continuously decrease the Zone number.

■ **Zone Up <ZONE ▲>**

Increases the zone number in steps of 1.

■ **Zone Up (Continuous) <ZONE ▲>**

Hold down this key to continuously increase the Zone number.

BASIC OPERATIONS









SWITCHING POWER ON/OFF

Turn the **Power** switch/ **Volume** control clockwise to switch the transceiver ON.

Turn the **Power** switch/ **Volume** control counterclockwise fully to switch the transceiver OFF.

■ Transceiver Password (Type I Only)

If the transceiver is password protected, "PASSWORD" will appear on the display when the power is turned On. To unlock the transceiver, enter the password:

- 1 Select a character using the /  keys.
 - Alternatively, you can enter the password directly by using the keypad.
- 2 Press the  key to enter the selected character.
 - This step is unnecessary when using the keypad.
- 3 Repeat steps 1 and 2 to enter the entire password.
 - Press the  or  key to delete a character. Press and hold  or  to delete all characters.
- 4 Press  or  to confirm the entry.
 - If you enter an incorrect password, an error tone sounds and the transceiver remains locked.
 - The password can contain a maximum of 6 digits.

ADJUSTING THE VOLUME

Rotate the **Power** switch/ **Volume** control to adjust the volume. Clockwise increases the volume and counterclockwise decreases it.

SELECTING A ZONE AND CHANNEL

Select the desired zone using the key programmed as **[Zone Up/ Down]**. Each zone contains a group of channels.

Select the desired channel using the **Selector** knob (default). Each channel is programmed with settings for transmitting and receiving.

- You can toggle the display between the zone and channel names and number by pressing the key programmed as **[Display Format]**, or by accessing the Menu.



Note: If the default settings for / and the **Selector** knob have been changed, use the appropriate keys to select the zone and channel.

TRANSMITTING

- 1 Select the desired zone and channel.
- 2 Press the key programmed as **[Monitor]** or **[Squelch Off]** to check whether or not the channel is free.
 - If the channel is busy, wait until it becomes free.
- 3 Press the **PTT** switch and speak into the microphone. Release the **PTT** switch to receive.
 - For best sound quality, hold the transceiver approximately 1.5 inches (3 ~ 4 cm) from your mouth.



■ Making Group Calls (Type I Only)

You can make calls to a group ID by using the key programmed as **[Contact List]**, or by accessing the Menu.

- 1 Press the key programmed as **[Contact List]**.
- 2 Press / to select a group ID/name from the list.
- 3 Press and hold the **PTT** switch to make the call.
 - Speak into the transceiver as you would during a normal transmission.

■ Making Individual Calls (Type I Only)

You can make calls to specific persons by using the key programmed as [**Contact List**], or by accessing the Menu.

- 1 Press the key programmed as [**Contact List**].
- 2 Press / to select a unit ID from the list.
 - You can also enter a unit ID directly by using the keypad.
- 3 Press and hold the **PTT** switch to make the call.
 - Speak into the transceiver as you would during a normal transmission.

RECEIVING

Select the desired zone and channel. If signaling has been programmed on the selected channel, you will hear a call only if the received signal matches your transceiver settings.

■ Receiving Group Calls

When you receive a group call and the received group ID matches the ID set on your transceiver, you can hear the caller's voice.

















■ Receiving Individual Calls

When you receive an individual call, a ringing tone will sound and the caller's ID will appear on the display. To respond to the call, press and hold the **PTT** switch and speak into the transceiver as you would during a normal transmission.

MENU MODE (TYPE I ONLY)

Many functions on this transceiver are selected or configured through the Menu instead of physical controls. Once you become familiar with the Menu system, you will appreciate the versatility it offers.

MENU ACCESS

- 1 Press the key programmed as **[Menu]**.
 - The category list appears. When there is only 1 category, the function list appears (proceed to step 4).
- 2 Press  /  to select a category.
- 3 Press  or  to view the function list.
- 4 Press  /  to select a function item.
- 5 Press  or  to set up the selected function.
 - Press  or  to return to the category list.
- 6 Press  /  to select your desired setting.
 - For settings with more than 1 level, repeat steps 5 and 6.
- 7 Press  or  to set the selected setting and exit Menu mode.
 - Press  or  at any time to return to the previous display.
 - Press  at any time to exit Menu mode.

MENU CONFIGURATION

Some transceiver keys may already be programmed with functions listed in the Menu. Those functions can be accessed directly by pressing the key. All other functions can still be accessed using the transceiver Menu. The following table lists the available Menu items.

Menu Item	Description
Activity Detection	Sets the Activity Detection function as on or off.
Broadcast	Sets the call type between Broadcast Call and Conference Call.
Contact List	Displays your contact list.
Display Format	Sets the display as the zone-channel number or name.
External Microphone Type	Sets the External microphone type as Microphone 1 or Microphone 2.
Fixed Volume	Sets the Tone level of the transceiver as High, Low, or off.
GPS Position Display	Displays your location data.
Home Channel Select	Sets the current channel as the Home Channel within the current zone.
LCD Brightness	Sets the LCD brightness as High, Medium, or Low.
Lone Worker	Toggles Lone Worker mode on and off.
Low Transmit Power	Sets the output power to low when using a channel programmed with high power.
Maintenance	Enter Maintenance Display mode.
Message	Enter Message mode.

Menu Item	Description
Minimum Volume	Set the smallest volume level after turning the Volume control to its minimum level.
Monitor	Sets the Monitor function as on or off.
OVCM	Sets the Open Voice Channel mode as on or off.
Receive Entry	Enter Receive Entry mode.
Remote Control	Enter Remote Control mode.
RX Audio Equalizer	Sets the receiver equalizer as flat (normal), high boost (treble boost), or low boost (bass boost).
RX Auto Gain Control	Sets the received audio volume level.
Scan	Start or stop scanning.
Scan Delete/Add	Adds or removes the selected channel to or from the scan sequence.
Scrambler	Toggles the Scrambler function on and off.
Scrambler key	Enter Scrambler key mode.
Selcall	Enter Selcall mode.
Selcall + Status	Enter Selcall mode. Press PF1 while in Selcall mode to enter Status mode.
Send the GPS Data	If programmed by your dealer, manually sends your GPS data to the base station.
Squelch Level	Enter Squelch level mode.
Squelch Off	Sets the Squelch Off function as on or off.
Stack	Places the transceiver in Stack mode.

Menu Item	Description
Status	Enter Status mode.
Talk Around	Sets Talk Around as on or off.
Transceiver Password	Enter Transceiver Password mode.
TX Audio Equalizer	Sets the transmission equalizer as flat (normal), high boost (treble boost), or low boost (bass boost).
TX Auto Gain Control	Sets the Auto Gain Control function for the microphone as on or off.
TX Noise Suppressor	Sets the TX Noise Suppressor function as on or off.
Zone Delete/ Add	Toggles the Zone status between deleted and added.

Note: The listed Menu items may change or additional items may be added.

ADVANCED OPERATIONS

TALK AROUND

Talk Around allows you to directly communicate with other transceivers without the use for a repeater.

To activate Talk Around, press the key programmed as **[Talk Around]** or access the Menu.

- The  icon appears on the display while Talk Around is active. To deactivate Talk Around, press the **[Talk Around]** key again.

KEY LOCK

Press the key programmed as **[Key Lock]** to lock and unlock the transceiver keys.

- The following keys still function when Key Lock is activated: Emergency, Backlight, Monitor, Monitor Momentary, Squelch Off, Squelch Off Momentary, Function, Key Lock, LCD Brightness, Call, PTT, and the Selector.

SCRAMBLER





Although the scrambler function does not offer complete privacy with your calls, it does prevent others from easily listening in on your calls. When activated, the transceiver distorts your voice so that anybody listening to your call will be unable to clearly hear what you are saying.

For members of your own group to clearly hear your call while you are using the scrambler, all other members must also activate the scrambler functions on their transceivers. This distorts everybody's voice while transmitting and corrects the voice message when you receive the call.

To activate the scrambler, press the key programmed as **[Scrambler]** or access the Menu.

- The  icon appears on the display while the scrambler is active. To deactivate the scrambler, press the **[Scrambler]** key again.

You can also change the scrambler key by holding the key programmed as **[Scrambler]**.

- 1 Press and hold the key programmed as **[Scrambler]**.
 - The current setting appears.
- 2 Press / to select a new scrambler code.
 - Be sure that all group members are using the same scrambler code.
- 3 Press  or  to set the selected setting and exit.

ACTIVITY DETECTION

Press the key programmed as **[Activity Detection]** to turn Activity Detection On and Off. If an event occurs while Activity Detection is enabled, for instance if the transceiver remains in the tilt or stationary state or is excessively in motion longer than the preconfigured time, the transceiver enters Emergency Mode.

Note:

- ◆ If programmed by your dealer, when Activity Detection has been turned off and the transceiver power is then turned off and back on, Activity Detection is automatically enabled.
- ◆ When using this function, verify that it operates before taking the transceiver.

■ Activity Reset

While Activity Detection is active, press the key programmed as **[Activity Reset]** to reset the Activity Detection countdown timer. This will allow you to remain in a tilted or stationary position, etc., Without the Emergency mode activating unnecessarily.





BACKLIGHT (Type I Only)

Press the key programmed as [**Backlight**] to turn the transceiver display backlight on.

- Once activated, the backlight remains on for a preset duration (set by your dealer).
- Pressing any key other than the **PTT** switch, the **Power** switch/**Volume** control, and the **Backlight** key while the backlight is on will reset the backlight timer, allowing it to remain lit for an additional duration.





To turn the transceiver backlight off immediately, press the [**Backlight**] key while the backlight is on.

You can also adjust the backlight brightness by pressing the key programmed as [**LCD Brightness**], or by accessing the Menu.

- 1 Press the key programmed as [**LCD Brightness**].
 - The current setting appears.
- 2 Press / to select a setting.
 - You can adjust the brightness between High, Medium, and Low.
- 3 Press  or  to set the selected setting and exit.

CHARACTER ENTRY (Type I Only)

There are 2 methods available for entering characters:

- ◆ Pressing the / keys
Press / to cycle the characters from A ~ Z, a ~ z, 0 ~ 9, and a space (default settings).
 - To toggle between capital letters, lower case letters, and numbers, press the  key.
- ◆ Using the keypad
Press the keypad keys to enter characters as shown in the table below:

Keypad	Character Cycle		
1			1
2	A B C	a b c	2
3	D E F	d e f	3
4	G H I	g h i	4
5	J K L	j k l	5
6	M N O	m n o	6
7	P Q R S	p q r s	7
8	T U V	t u v	8
9	W X Y Z	w x y z	9
0	[space]	[space]	0

BACKGROUND OPERATIONS

Your dealer can activate a variety of transceiver functions to perform without any additional operation on your part.

TIME-OUT TIMER (TOT)

The Time-out Timer prevents you from using a channel for an extended duration. If you continuously transmit for a preset time, the transceiver will stop transmitting and an alert tone will sound. Release the **PTT** switch.

BATTERY SAVER

The Battery Saver decreases the amount of power used when a signal is not being received and no operations are being performed, elongating your battery life.

LOW BATTERY WARNING (Type I Only)

Your dealer can set an alert tone to sound and the LED indicator to blink red when the battery power is low. The battery power icon displays the battery power remaining, as shown below. When the battery power is very low, recharge or replace the battery pack.



High

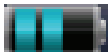

Sufficient



Low



Very low

SIGNAL STRENGTH INDICATOR (Type I Only)

The signal strength indicator displays the strength of received calls. No icon appears when no signal is available.



Strong



Sufficient



Weak



Very weak

COMPANDER

If programmed by your dealer for a channel, the compander will remove excessive noise from transmitted signals, to provide higher clarity of signals.

BUSY CHANNEL LOCKOUT (BCL)

When activated, BCL prevents you from interfering on a channel that is already in use. Pressing the **PTT** switch will cause an alert tone to sound and the transceiver will not transmit. Release the **PTT** switch to stop the tone.

If BCL Override has been programmed, you can transmit over the current signal:

- 1 Press and hold the **PTT** switch.
 - If the channel is already in use, a warning tone will sound.
- 2 Quickly release and then press the **PTT** switch again.
- 3 Speak into the transceiver as you would during a normal call.

VOICE ANNUNCIATION

When changing the zone and/or channel, an audio voice will announce the new zone and channel number.

KENWOOD

CE0168!