

# KENWOOD

## KDC-BT73DAB KDC-BT53U KDC-5057SD

---

### CD-RECEIVER INSTRUCTION MANUAL

JVC KENWOOD Corporation



# Contents

<b>1. Before use</b>	<b>4</b>	<b>8. Listen to the CD/ Audio file</b>	<b>36</b>
1-1. Safety precaution		8-1. Playing music	
1-2. Important information		8-2. Music search	
1-3. Regulatory Compliance		8-3. Skip search	
<b>2. Appendix</b>	<b>8</b>	8-4. Skip search ratio setting	
2-1. Specifications		8-5. Playback mode	
2-2. Trademarks		8-6. About the Audio file	
<b>3. Basic operations</b>	<b>12</b>	8-7. About the USB device	
3-1. Component names		8-8. About SD card	
3-2. Preparations		8-9. About "KENWOOD Music Editor Light" and "KENWOOD Music Control"	
3-3. How to select the item		8-10. About the discs used with this unit	
3-4. General operations		8-11. Handling discs	
<b>4. Audio adjustments (KDC-5057SD)</b>	<b>16</b>	<b>9. Listen to the tuner</b>	<b>42</b>
4-1. Audio control		9-1. Listening to the radio	
4-2. Audio preset		9-2. Station preset memory	
4-3. Audio preset recall		9-3. Auto memory	
<b>5. DSP settings (KDC-BT73DAB, KDC-BT53U)</b>	<b>18</b>	9-4. Recall preset station	
5-1. Audio control		9-5. Tuner setting	
5-2. Manual equalizer control		9-6. PTY (Program Type)	
5-3. Car type selection		<b>10. Listen to the Digital Radio (KDC-BT73DAB)</b>	<b>46</b>
5-4. Speaker setting		10-1. Listening to the Digital Radio	
5-5. X'Over setting		10-2. Service preset memory	
5-6. Listening position setting		10-3. Recall preset service	
5-7. Delay time control		10-4. Service list select	
5-8. Channel level fine adjustments		10-5. Alphabet Search for service	
5-9. Resetting of DTA Settings		10-6. PTY (Program Type)	
5-10. DSP preset		10-7. Announcement setup	
5-11. DSP preset recall		10-8. Replay	
<b>6. Listen to the iPod</b>	<b>26</b>	10-9. Digital Radio setting	
6-1. Models of iPods/iPhones that can be connected to this unit		10-10. Digital Radio initial settings	
6-2. Playing music		<b>11. Display settings</b>	<b>52</b>
6-3. Music search		11-1. Selecting a display type	
6-4. Alphabet search		11-2. Information display setting	
6-5. Direct search		11-3. Illumination color selection	
6-6. Skip search		11-4. Adjusting the Illumination color	
6-7. Skip search ratio setting		11-5. Selecting a text display	
6-8. Playback mode		11-6. Display & Illumination setting	
6-9. App & iPod mode setting		<b>12. General settings</b>	<b>58</b>
<b>7. Aha Radio (KDC-BT73DAB, KDC-BT53U)</b>	<b>32</b>	12-1. Adjusting the clock	
7-1. Requirements Aha™		12-2. Adjusting the date	
7-2. Listening to the Aha Radio		12-3. Clock & date display type setting	
7-3. Basic operations		12-4. Auxiliary input display setting	
7-4. Station search		12-5. Muting the audio upon reception of a phone call	
7-5. Calling a number in the content		12-6. Demonstration mode setting	
7-6. Aha source control		12-7. Initial settings	

### **13. Registering a Bluetooth (KDC-BT73DAB, KDC-BT53U) 62**

---

- 13-1. About the Bluetooth module
- 13-2. Registering a Bluetooth device
- 13-3. Selecting the Bluetooth device you wish to connect
- 13-4. Deleting a registered Bluetooth device
- 13-5. Bluetooth device registration test

### **14. Hands-free phoning (KDC-BT73DAB, KDC-BT53U) 66**

---

- 14-1. Receiving a call
- 14-2. Calling a number in the phone book
- 14-3. Dialing a number
- 14-4. Calling a number in the call log
- 14-5. Speed dialing (Preset dial)
- 14-6. Registering in the preset dial number list
- 14-7. During a call
- 14-8. Clearing the disconnection message
- 14-9. Voice Control
- 14-10. Display of phone number types (categories)

### **15. Bluetooth audio (KDC-BT73DAB, KDC-BT53U) 72**

---

- 15-1. Before use
- 15-2. Basic operations
- 15-3. Playback mode

### **16. Bluetooth settings (KDC-BT73DAB, KDC-BT53U) 74**

---

- 16-1. Registering the PIN code
- 16-2. Downloading the phone book
- 16-3. Deleting the phone book
- 16-4. Displaying the firmware version
- 16-5. Switching between two connected cell-phones
- 16-6. Bluetooth detail setting

### **17. Troubleshooting guide 78**

---

- 17-1. Setting error
- 17-2. Operation/wiring error
- 17-3. Error messages

# 1. Before use

## 1-1. Safety precaution

### ▲ WARNING

To prevent injuries or a fire, take the following precautions:

- Stop the car before operating the unit.
- To prevent a short circuit, never put or leave any metallic objects (such as coins or metal tools) inside the unit.

### ▲ CAUTION

- Adjust the volume so that you can hear the sound outside the car. Driving with the volume too high may cause an accident.
- Wipe off the dirt on the panel with a dry silicon or soft cloth.  
Failure to observe this precaution may result in damage to the monitor or unit.
- If you experience problems during installation, consult your Kenwood dealer.

## 1-2. Important information

### Before using the this unit for the first time

This unit is factory-set to operate in the Demonstration mode initially.

When using this unit for the first time, cancel the Demonstration mode. Refer to [<Cancel the Demonstration mode>](#) (page 13).

### Cleaning the connector

The unit may not function properly if the connectors between the unit and faceplate are dirty. Detach the faceplate and clean the connector with a cotton swab gently, being careful not to damage the connector.



### Condensation

When the car is air-conditioned, moisture may collect on the laser lens. This may cause disc read errors. In this case, remove the disc and wait for the moisture to evaporate.

### How to reset your unit

If the unit fails to operate properly, press the Reset button. The unit returns to the factory settings when the Reset button is pressed.

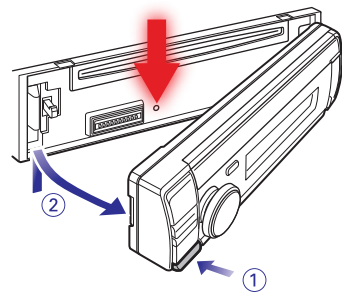

### Notes

- When you purchase optional accessories, check with your Kenwood dealer to make sure that they can work with your model and in your area.
- Characters that conform to ISO 8859-1 can be displayed.
- Characters that conform to ISO 8859-5 or ISO 8859-1 can be displayed. Refer to "Russian" of [<12-7. Initial settings>](#) (page 61).
- The illustrations of the display and panel appearing in this manual are examples used to explain more

clearly how the controls are used. Therefore, what appears on the display in the illustrations may differ from what appears on the display on the actual equipment, and some of the images on the display may be inapplicable.

- USB rating is indicated on the main unit under the detachable faceplate.

## Before use

### 1-3. Regulatory Compliance

#### Information on Disposal of Old Electrical and Electronic Equipment and Batteries (applicable for EU countries that have adopted separate waste collection systems)



Products and batteries with the symbol (crossed-out wheeled bin) cannot be disposed as household waste. Old electrical and electronic equipment and batteries should be recycled at a facility capable of handling these items and their waste byproducts.



Contact your local authority for details in locating a recycle facility nearest to you. Proper recycling and waste disposal will help conserve resources whilst preventing detrimental effects on our health and the environment. Notice: The sign "Pb" below the symbol for batteries indicates that this battery contains lead.

#### The marking of products using lasers



The label is attached to the chassis/case and says that the component uses laser beams that have been classified as Class 1. It means that the unit is utilizing laser beams that are of a weaker class. There is no danger of hazardous radiation outside the unit.



#### Declaration of Conformity with regard to the EMC Directive 2004/108/EC

#### Declaration of Conformity with regard to the R&TTE Directive 1999/5/EC

#### Manufacturer:

JVC KENWOOD Corporation

3-12, Moriyacho, Kanagawa-ku, Yokohama-shi, Kanagawa 221-0022, JAPAN

#### EU Representative:

Kenwood Electronics Europe BV  
Amsterdamseweg 37, 1422 AC UITHOORN, The Netherlands

#### English

Hereby, JVC KENWOOD declares that this unit KDC-BT73DAB, KDC-BT53U is in compliance with the essential requirements and other relevant provisions of Directive 1999/5/EC.

#### Français

Par la présente JVC KENWOOD déclare que l'appareil KDC-BT73DAB, KDC-BT53U est conforme aux exigences essentielles et aux autres dispositions pertinentes de la directive 1999/5/CE. Par la présente, JVC KENWOOD déclare que ce KDC-BT73DAB, KDC-BT53U est conforme aux exigences essentielles et aux autres dispositions de la directive 1999/5/CE qui lui sont applicables.

#### Deutsch

Hiermit erklärt JVC KENWOOD, dass sich dieser KDC-BT73DAB, KDC-BT53U in Übereinstimmung mit den grundlegenden Anforderungen und den anderen relevanten Vorschriften der Richtlinie 1999/5/EG befindet. (BMWi)  
Hiermit erklärt JVC KENWOOD die Übereinstimmung des Gerätes KDC-BT73DAB, KDC-BT53U mit den grundlegenden Anforderungen und den anderen relevanten Festlegungen der Richtlinie 1999/5/EG. (Wien)

#### Nederlands

Hierbij verklaart JVC KENWOOD dat het toestel KDC-BT73DAB, KDC-BT53U in overeenstemming is met de essentiële eisen en de andere relevante bepalingen van richtlijn 1999/5/EG. Bij deze verklaart JVC KENWOOD dat deze KDC-BT73DAB, KDC-BT53U voldoet aan de essentiële eisen en aan de overige relevante bepalingen van Richtlijn 1999/5/EC.

#### Italiano

Con la presente JVC KENWOOD dichiara che questo KDC-BT73DAB, KDC-BT53U è conforme ai requisiti essenziali ed alle altre disposizioni pertinenti stabilite dalla direttiva 1999/5/CE.

#### Español

Por medio de la presente JVC KENWOOD declara que el KDC-BT73DAB, KDC-BT53U cumple con

los requisitos esenciales y cualesquiera otras disposiciones aplicables o exigibles de la Directiva 1999/5/CE.

### **Português**

JVC KENWOOD declara que este KDC-BT73DAB, KDC-BT53U está conforme com os requisitos essenciais e outras disposições da Directiva 1999/5/CE.

### **Polska**

JVC KENWOOD niniejszym oświadcza, że KDC-BT73DAB, KDC-BT53U spełnia zasadnicze wymagania oraz inne istotne postanowienia dyrektywy 1999/5/EC.

### **Český**

JVC KENWOOD tímto prohlašuje, že KDC-BT73DAB, KDC-BT53Ue ve shode se základními požadavky a s dalšími příslušnými ustanoveními Nařízení vlády č. 426/2000 Sb.

### **Magyar**

Alulírott, JVC KENWOOD, kijelenti, hogy a jelen KDC-BT73DAB, KDC-BT53U megfelel az 1999/5/EC irányelvben meghatározott alapvető követelményeknek és egyéb vonatkozó előírásoknak.

### **Svenska**

Härmed intygar JVC KENWOOD att denna KDC-BT73DAB, KDC-BT53U står i överensstämmelse med de väsentliga egenskapskrav och övriga relevanta bestämmelser som framgår av direktiv 1999/5/EG.

### **Suomi**

JVC KENWOOD vakuuttaa täten että KDC-BT73DAB, KDC-BT53U tyyppinen laite on direktiivin 1999/5/EY oleellisten vaatimusten ja sitä koskevien direktiivin muiden ehtojen mukainen.

### **Slovensko**

S tem JVC KENWOOD izjavlja, da je ta KDC-BT73DAB, KDC-BT53U v skladu z osnovnimi zahtevami in ostalimi ustreznimi predpisi Direktive 1999/5/EC.

### **Slovensky**

Spoločnosť JVC KENWOOD týmto vyhlasuje, že KDC-BT73DAB, KDC-BT53U spĺňa základné požiadavky a ďalšie príslušné ustanovenia Direktívy 1999/5/EC.

### **Dansk**

Undertegnede JVC KENWOOD erklærer herved, at følgende udstyr KDC-BT73DAB, KDC-BT53U overholder de væsentlige krav og øvrige relevante krav i direktiv 1999/5/EF.

### **Ελληνικά**

ΜΕ ΤΗΝ ΠΑΡΟΥΣΑ JVC KENWOOD ΔΗΛΩΝΕΙ ΟΤΙ

KDC-BT73DAB, KDC-BT53U ΣΥΜΜΟΡΦΩΝΕΤΑΙ ΠΡΟΣ ΤΙΣ ΟΥΣΙΩΔΕΙΣ ΑΠΑΙΤΗΣΕΙΣ ΚΑΙ ΤΙΣ ΛΟΙΠΕΣ ΣΧΕΤΙΚΕΣ ΔΙΑΤΑΞΕΙΣ ΤΗΣ ΟΔΗΓΙΑΣ 1999/5/ΕΚ.

### **Eesti**

Sellega kinnitab JVC KENWOOD, et see KDC-BT73DAB, KDC-BT53U vastab direktiivi 1999/5/EC põhilistele nõudmistele ja muudele asjakohastele määrustele.

### **Latviešu**

Ar šo, JVC KENWOOD, apstiprina, ka KDC-BT73DAB, KDC-BT53U atbilst Direktīvas 1999/5/EK galvenajām prasībām un citiem tās nosacījumiem.

### **Lietuviškai**

Šiuo, JVC KENWOOD, pareiškia, kad šis KDC-BT73DAB, KDC-BT53U atitinka pagrindinius Direktyvos 1999/5/EB reikalavimus ir kitas svarbias nuostatas.

### **Malti**

Hawnhekk, JVC KENWOOD, jiddikjara li dan KDC-BT73DAB, KDC-BT53U jikkonforma mal-htigijiet essenzjali u ma provvedimenti oħrajn relevanti li hemm fid-Dirrettiva 1999/5/EC.

### **Українська**

Компанія JVC KENWOOD заявляє, що цей виріб KDC-BT73DAB, KDC-BT53U відповідає ключовим вимогам та іншим пов'язаним положенням Директиви 1999/5/EC.

### **Turkish**

JVC KENWOOD, işbu belge ile KDC-BT73DAB, KDC-BT53U numaralı bu ünitinin 1999/5/EC Direktifi'nin özel gereksinimlerine ve ilgili diğer hükümlerine uygun olduğunu beyan eder.

## 2. Appendix

### 2-1. Specifications

---

#### FM tuner section

---

- Frequency range (50 kHz step)
  - : 87.5 MHz – 108.0 MHz
- Usable sensitivity (S/N = 30dB)
  - : 7.2 dBf (0.63  $\mu$ V/75  $\Omega$ )
- Quieting Sensitivity (S/N = 46dB)
  - : 15.2 dBf (1.6  $\mu$ V/75  $\Omega$ )
- Frequency response ( $\pm$ 3 dB)
  - : 30 Hz – 15 kHz
- Signal to Noise ratio (MONO)
  - : 75 dB ( $\pm$ 400 kHz)
- Stereo separation
  - : 45 dB (1 kHz)

#### MW tuner section

---

- Frequency range (9 kHz step)
  - : 531 kHz – 1611 kHz
- Usable sensitivity (S/N = 20dB)
  - : 36  $\mu$ V

#### LW tuner section

---

- Frequency range (9 kHz step)
  - : 153 kHz – 279 kHz
- Usable sensitivity (S/N = 20dB)
  - : 57  $\mu$ V

#### DAB tuner section (KDC-BT73DAB)

---

- Frequency range
  - L-BAND: 1452.960 MHz – 1490.624 MHz
  - BAND III : 174.928 MHz – 239.200 MHz
- Sensitivity
  - : -100 dBm
- Signal to Noise ratio
  - : 80 dB
- Antenna Connector type
  - : SMB
- Antenna Output Voltage (11 – 16V)
  - : 14.4 V
- Antenna Maximun Current
  - : <100 mA

#### CD player section

---

- Laser diode
  - : GaAlAs
- Digital filter (D/A)
  - : 8 Times Over Sampling
- D/A Converter
  - : 24 Bit
- Spindle speed (Audio files)
  - : 500 – 200 rpm (CLV)
- Wow & Flutter
  - : Below Measurable Limit
- Frequency response ( $\pm$ 1 dB)
  - : 10 Hz – 20 kHz
- Total harmonic distortion (1 kHz)
  - : 0.008 %
- Signal to Noise ratio (1 kHz)
  - : 110 dB
- Dynamic range
  - : 93 dB
- MP3 decode
  - : Compliant with MPEG-1/2 Audio Layer-3
- WMA decode
  - : Compliant with Windows Media Audio
- AAC decode
  - : AAC-LC ".m4a" files

#### USB interface

---

- USB Standard
  - : USB1.1/ 2.0 (Full speed)
- File System
  - : FAT12 / 16 / 32
- Maximum Supply current
  - : DC 5 V  $\leq$  1 A
- Decode
  - : MP3, WMA, AAC, WAV

#### SD section (KDC-5057SD)

---

- Compatible physical format
  - : Version 2.00
- Maximum memory capacity
  - : 32GB
- File system
  - : FAT12 / 16 / 32
- MP3 decode
  - : Compliant with MPEG-1/2 Audio Layer-3
- WMA decode
  - : Compliant with Windows Media Audio
- AAC decode
  - : AAC-LC ".m4a" files
- WAV decode
  - : Linear-PCM



## Audio section

---

Maximum output power  
: 50 W x 4  
Output power (DIN45324,+B=14.4V)  
: 30 W x 4  
Preout level/ Load (CD)  
: 2500 mV/10 k $\Omega$   
Preout impedance  
:  $\leq$  600  $\Omega$   
Speaker Impedance  
: 4 – 8  $\Omega$   
Tone

### **KDC-BT73DAB** **KDC-BT53U**

Band1 : 62.5 Hz  $\pm$ 9 dB  
Band2 : 100 Hz  $\pm$ 9 dB  
Band3 : 160 Hz  $\pm$ 9 dB  
Band4 : 250 Hz  $\pm$ 9 dB  
Band5 : 400 Hz  $\pm$ 9 dB  
Band6 : 630 Hz  $\pm$ 9 dB  
Band7 : 1 kHz  $\pm$ 9 dB  
Band8 : 1.6 kHz  $\pm$ 9 dB  
Band9 : 2.5 kHz  $\pm$ 9 dB  
Band10 : 4 kHz  $\pm$ 9 dB  
Band11 : 6.3 kHz  $\pm$ 9 dB  
Band12 : 10 kHz  $\pm$ 9 dB  
Band13 : 16 kHz  $\pm$ 9 dB

### **KDC-5057SD**

Bass : 100 Hz  $\pm$ 8 dB  
Middle : 1 kHz  $\pm$ 8 dB  
Treble : 12.5 kHz  $\pm$ 8 dB

## Bluetooth section (KDC-BT73DAB/ KDC-BT53U)

---

Version  
: Bluetooth Ver. 2.1+EDR Certified  
Frequency range  
: 2.402 – 2.480 GHz  
Output Power  
: +4dBm (MAX), 0dBm (AVE) Power Class 2  
Maximum Communication range  
: Line of sight approx.10m (32.8 ft)  
Profiles  
: HFP (Hands Free Profile)  
: SPP (Serial Port Profile)  
: PBAP (Phonebook Access Profile)  
: OPP (Object Push Profile)  
: A2DP (Advanced Audio Distribution Profile)  
: AVRCP (Audio/Video Remote Control Profile)

## Auxiliary input

---

Frequency response ( $\pm$ 3 dB)  
: 20 Hz – 20 kHz  
Input Maximum Voltage  
: 1200 mV  
Input Impedance

: 10 k $\Omega$

## General

---

Operating voltage  
**KDC-BT73DAB** **KDC-BT53U**  
: 14.4 V (10.5 – 16V allowable)  
**KDC-5057SD**  
: 14.4 V (11 – 16V allowable)  
Maximum Current consumption  
: 10 A  
Installation Size (W x H x D)  
: 182 x 53 x 159 mm  
Weight  
**KDC-BT73DAB** **KDC-BT53U**  
: 1.3 kg  
**KDC-5057SD**  
: 1.2 kg

Specifications subject to change without notice.

# Appendix

## 2-2. Trademarks

---



- The Bluetooth word mark and logos are owned by the Bluetooth SIG, Inc. and any use of such marks by JVC KENWOOD Corporation is under license. Other trademarks and trade names are those of their respective owners.



- "Made for iPod" and "Made for iPhone" mean that an electronic accessory has been designed to connect specifically to iPod or iPhone, respectively, and has been certified by the developer to meet Apple performance standards. Apple is not responsible for the operation of this device or its compliance with safety and regulatory standards. Please note that the use of this accessory with iPod or iPhone may affect wireless performance.
- iPhone, iPod, iPod classic, iPod nano, and iPod touch are trademarks of Apple Inc., registered in the U.S. and other countries.
- iTunes and Safari are trademark of Apple Inc.



- aha, the Aha logo, and the Aha trade dress are trademarks or registered trademarks of HARMAN International Industries, used with permission.
- Android and Chrome are trademark of Google Inc.



- Internet Explorer and Windows Media are registered trademark of Microsoft Corporation in the United States and other countries.



- The "AAC" logo is a trademark of Dolby Laboratories.



- SDHC Logo is a trademark of SD-3C, LLC.





## 3. Basic operations

### 3-1. Component names

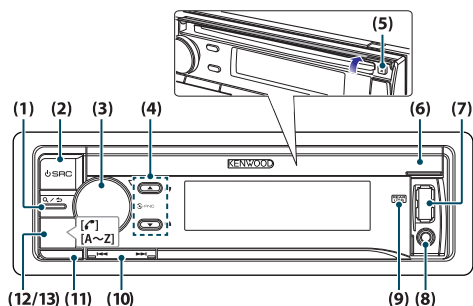

(1) [Q/S] button

When listening to the iPod, audio file, CD, or radio, press this button to enter the search mode. In each of the selected modes, press the button to return to the previous item.

(2) [SRC] button

Press the button to select the source. Refer to [<Source selection>](#) (page 14).

(3) [Control] knob (Volume knob)

In the normal mode, turn the knob to adjust the volume or press the knob to enter the Function setting mode. In the Function mode, turn the knob to select an item or press the knob to determine the selection.

(4) [▲]/[▼] button

Press the button to select an audio file folder or broadcast band, or use it as a Likes/ Dislikes button on Aha etc.

(5) [▲] button

Press the button to eject the disc.

(6) Disc slot cover

When this cover opens upward, the disc insertion slot appears

(7) USB terminal (inside of the cover)

Connect an iPod or USB device.

(8) Auxiliary input (inside of the cover)

Connect the output of an external device using a stereo mini-jack.

(9) REAR USB indicator

When a USB device or iPod is connected to the USB terminal of the rear, this indicator stays lit. During

playback of the connected device, this indicator blinks.

(10) [◀◀]/[▶▶] button

Press the button to select a song or station.

(11) Release button

Press the button to detach the faceplate.

(12) [KDC-BT73DAB] [KDC-BT53U] [📞] button

Press the button to make, answer, or disconnect a hands-free call.

(13) [KDC-5057SD] [A~Z] button

Press any of (A to Z) button during the Music search mode to enter the alphabet search mode.

## 3-2. Preparations

### Cancel the Demonstration mode

Cancel the Demonstration mode when you use the unit for the first time after installation.

**1 Press [Control] knob to cancel the Demonstration mode when the message "To cancel DEMO Press the volume knob" appears (approx. 15 seconds).**

**2 Turn [Control] knob to select the "YES", and then press [Control] knob.**

The Demonstration mode can also be canceled in the Function Setting mode. Refer to <12-6. Demonstration mode setting> (page 60).

### Detaching/ Attaching the faceplate

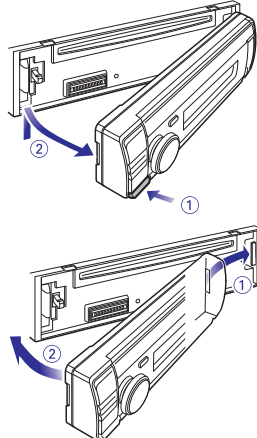

- Remove the faceplate at once after pressing the Release button; otherwise it can fall down due to vibration.
- The faceplate is a precision component of the unit and can be damaged by shocks or jolts.
- Keep the faceplate in its case while detached.
- Do not place the faceplate (and case) in areas exposed to direct sunlight, excessive heat or humidity. Also avoid places with too much dust or the possibility of water splashing.

## 3-3. How to select the item

For how to select setting items such as a function setting item, see the following example:

### Example: Setting the Date format of the display

**1 Press [Control] knob.**

"Function" appears and enters the Function setting mode.

**2 Select the Date Mode function item.**

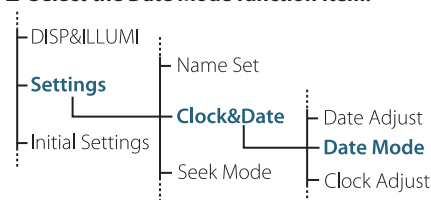

Turn [Control] knob to select "Settings", and then press [Control] knob.

Next, turn [Control] knob to select "Clock&Date", and then press [Control] knob. Finally, turn [Control] knob to select "Date Mode", and then press [Control] knob.

To cancel and return to the previous item, press [Q/↵].

**3 Turn [Control] knob to select a format (7 types), and then press [Control] knob.**

Returns to the previous item.

**4 Press and hold [Q/↵].**

Exits the Function setting mode.

### About the description in this manual

- In this manual, operations performed in steps 2 and 3 are described as follows:
  - 2 Select "Settings" > "Clock&Date" > "Date Mode" using [Control knob].**
  - 3 Select a format (7 types) using [Control] knob.**

# Basic operations

## 3-4. General operations

### Power

Press [SRC] to turn the power ON.

Press and hold [SRC] to turn the power OFF.

### Source selection

Press [SRC].

The source will switch each time upon pressing the button.

Source	Display
Standby	"STANDBY"
Digital radio <sup>[2]</sup>	"DIGITAL RADIO"
Tuner	"TUNER"
USB device connected to front USB terminal	"USB(FRONT)"
USB device connected to rear USB terminal	"USB(REAR)"
iPod connected to front USB terminal <sup>[1]</sup>	"iPod(FRONT)"
iPod connected to rear USB terminal <sup>[1]</sup>	"iPod(REAR)"
aha™ of iPod connected to front USB terminal <sup>[1]</sup> <sup>[2]</sup> <sup>[3]</sup>	"aha(FRONT)"
aha™ of iPod connected to rear USB terminal <sup>[1]</sup> <sup>[2]</sup> <sup>[3]</sup>	"aha(REAR)"
aha™ of device connected via Bluetooth <sup>[1]</sup> <sup>[2]</sup> <sup>[3]</sup>	"aha"
Bluetooth audio <sup>[2]</sup> <sup>[3]</sup>	"BT AUDIO"
SD <sup>[1]</sup> <sup>[4]</sup>	"SD"
CD <sup>[1]</sup>	"CD"
Auxiliary Input	"AUX"

<sup>[1]</sup> This source can be selected only when it can be played.

<sup>[2]</sup> Function of KDC-BT73DAB.

<sup>[3]</sup> Function of KDC-BT53U.

<sup>[4]</sup> Function of KDC-5057SD.

### Setting the source switching

- Source switching can be set so that pressing [SRC] switches among sources. For more details, refer to <12-7. Initial settings> (page 61).
- Source switching can be set so that "aha" and "AUX" sources can not be selected when not in use. For more details, refer to <12-7. Initial settings> (page 61).

### Volume

Turn [Control] knob.

### USB terminal

A USB device or iPod can be connected.

The CA-U1EX (Max. 500mA) or KCA-iP102 (optional accessories) is recommended to connect a USB device or iPod.

### Auxiliary input

A portable audio device can be connected with a stereo mini-plug (3.5 mm ø).



## 4. Audio adjustments (KDC-5057SD)

### 4-1. Audio control

You can adjust the audio control items.

#### 1 Press [SRC] to select a source other than Standby ("STANDBY").

Refer to <Source selection> (page 14).

#### 2 Press [Control] knob.

Enters the Function setting mode.

#### 3 Select "Audio Control" using [Control] knob.

For how to use [Control] knob, refer to <3-3. How to select the item> (page 13).

#### 4 Select a audio control item using [Control] knob.

Display	Audio control item	Range
"SubWoofer Level"	Subwoofer level	-15 — +15 (dB)
"Bass Level"	Bass level	-8 — +8 (dB)
"Middle Level"	Middle level	-8 — +8 (dB)
"Treble Level"	Treble level	-8 — +8 (dB)
"Equalizer PRO"		
"Bass Adjust"		
"Bass Center FRQ"	Bass Center Frequency	60/ 80/ 100/ 200 (Hz)
"Bass Level"	Bass level	-8 — +8 (dB)
"Bass Q Factor"	Bass Q Factor	1.00/ 1.25/ 1.50/ 2.00
"Bass EXT"	Bass Extend	OFF/ ON
"Middle Adjust"		
"Middle Center FRQ"	Middle Center Frequency	0.5/ 1.0/ 1.5/ 2.5 (kHz)
"Middle Level"	Middle level	-8 — +8 (dB)
"Middle Q Factor"	Middle Q Factor	0.75/ 1.00/ 1.25
"Treble Adjust"		
"Treble Center FRQ"	Treble Center Frequency	10.0/ 12.5/ 15.0/ 17.5 kHz
"Treble Level"	Treble level	-8 — +8 (dB)
"Preset Equalizer"	Preset Equalizer curve	"Rock"/ "Pops"/ "Easy"/ "Top40"/ "Jazz"/ "Powerful"/ "Natural"/ "User" [2]
"Bass Boost"	Bass Boost	"Level1"/ "Level2"/ "Level3"/ "OFF"
"Loudness"	Loudness	"Level1"/ "Level2"/ "OFF"
"Balance"	Balance	Left 15 — Right 15
"Fader"	Fader	Rear 15 — Front 15
"SubWoofer"	Subwoofer output	OFF/ ON

"Detailed Settings"		
"HPF"	High Pass Filter	Through/ 100/ 120/ 150 (Hz)
"LPF SubWoofer"	Low Pass Filter	85/ 120/ 160/ Through (Hz)
"SubWoofer Phase"	Subwoofer Phase	Reverse (180°)/ Normal (0°)
"Supreme" [3]	Supreme setting	ON/ OFF
"Audio Preset"	Audio Preset memory [1]	Recall/ Memory
"Volume Offset"	Volume offset	-8 — ±0 (dB) (AUX: -8 — +8)

[1] Refer to <4-2. Audio preset> (page 17), <4-3. Audio preset recall> (page 17).

[2] "User": The customized Bass, Middle, and Treble settings are effective.

[3] Audio file source only

#### 5 Select a value using [Control] knob.

Returns to the previous item.

#### Exiting from the Function setting mode

Press and hold [Q/⏏].

#### Adjusting Bass, Middle, and Treble levels

- You can set Bass, Middle, and Treble levels for each source.



## 4-2. Audio preset

---

You can register the values set the Audio control items.

### 1 Set the audio control items

Refer to <4-1. Audio control> (page 16).

### 2 Select "Audio Control" > "Detailed Settings" > "Audio Preset" > "Memory" using [Control] knob.

For how to use [Control] knob, refer to <3-3. How to select the item> (page 13).

### 3 Select "YES" using [Control] knob.

"Memory Completed" appears.

### **Exiting from the Function setting mode**

Press and hold [Q/↶].

### **Number of Audio preset memories that can be stored**

- Register a pair of Audio preset memories. You cannot register them by source.

### **When reset**

- When you press the Reset button, audio control values of all sources will be set to the values registered here.

### **Audio control items that can be registered**

- The following Audio control items can be registered.  
"Bass Center FRQ", "Bass Level", "Bass Q Factor", "Bass EXT",  
"Middle Center FRQ", "Middle Level", "Middle Q Factor",  
"Treble Center FRQ", "Treble Level", "SubWoofer Level", "HPF",  
"LPF SubWoofer", "SubWoofer Phase"

## 4-3. Audio preset recall

---

You can recall the Audio control items registered to the <4-2. Audio preset> (page 17).

### 1 Press [SRC] to select a recall source.

Refer to <Source selection> (page 14).

### 2 Press [Control] knob.

Enters the Function setting mode.

### 3 Select "Audio Control" > "Detailed Settings" > "Audio Preset" > "Recall" using [Control] knob.

For how to use [Control] knob, refer to <3-3. How to select the item> (page 13).

### 4 Select "YES" using [Control] knob.

"Recall Completed" appears.

### **Exiting from the Function setting mode**

Press and hold [Q/↶].

## 5. DSP settings (KDC-BT73DAB, KDC-BT53U)

### 5-1. Audio control

You can adjust the audio control items.

#### 1 Press [SRC] to select a source other than Standby ("STANDBY").

Refer to <Source selection> (page 14).

#### 2 Press [Control] knob.

Enters the Function setting mode.

#### 3 Select "Audio Control" using [Control] knob.

For how to use [Control] knob, refer to <3-3. How to select the item> (page 13).

#### 4 Select a audio control item using [Control] knob.

Display	Overview
"SubWoofers Level"	You can set subwoofer level. "-15" — "0" — "+15"
"Preset Equalizer"[1][4]	Select from among preset equalizer curves to set the sound quality. "User"[2] / "Natural" / "Rock" / "Pops" / "Easy" / "Top 40" / "Jazz" / "Powerful" / "iPod"(During iPod source only)
"Manual Equalizer"[1][4]	Set the equalizer curve manually. Refer to <5-2. Manual equalizer control> (page 19).
"Pro Setup"	
"DSP Set"	Turn on/off the DSP function. "Bypass": Disables the DSP function. "Through": Enables the DSP function.
"Car Type"[4]	To get clear sound, set the sound environment according to the location and size of physically installed speakers with reference to the followings:
"Speaker Setting"[4]	<5-3. Car type selection> (page 19)
"X'Over"[4]	<5-4. Speaker setting> (page 20)
"DTA Settings"[4]	<5-5. X'Over setting> (page 20)
	<5-6. Listening position setting> (page 21)
	<5-7. Delay time control> (page 21)
	<5-8. Channel level fine adjustments> (page 22)
	<5-9. Resetting of DTA Settings> (page 23)
"Sound Enhancements"[4]	
"Supreme"[5]	Turns ON/OFF the Supreme function. Can be set while Audio file source of USB/CD and iPod source. "ON" / "OFF"
"HIGHWAY-SOUND"[3]	Compensates the low volume or bass sound being lost by road noises to make vocal sound clearer. "OFF" / "Low" / "Middle" / "High"
"Space Enhancer"[3]	Virtually enhances the sound space using the DSP. "OFF" / "Small" / "Medium" / "Large"

"Sound Realizer"	Virtually makes the sound more realistic using the DSP. "OFF" / "Level1" / "Level2" / "Level3"
"Sound Elevation"	Virtually raises the sound field using the DSP. "OFF" / "Low" / "Middle" / "High"
"Volume offset"	Sets each source's volume as a difference from the basic volume. "-8" — "0" (AUX: "-8" — "+8")
"Rear Mute"	Sets the Rear channel Mute. "ON" / "OFF"
"Subwoofer Mute"	Sets the Subwoofer Mute. "ON" / "OFF"
"Audio Preset"	You can register the values set the Audio control items. Refer to <5-10. DSP preset> (page 24), <5-11. DSP preset recall> (page 24).
"Bass Boost"[4]	Sets the Bass Boost level in 3 steps. "OFF" / "Level1" / "Level2" / "Level3"
"Loudness"[4]	Makes the sounds at high and low frequencies louder. "OFF" / "Low" / "High"
"Balance"	Adjusts left/right speaker balance. "Left15" — "0" — "Right15"
"Fader"	Adjusts front/rear speaker balance. "Rear15" — "0" — "Front15"

(Colored text: Factory setting)

[1] You can select for each source.

[2] "User": The Equalizer curve set in the section <5-2. Manual equalizer control> (page 19) is recalled.

[3] This function is not effective for the Tuner and Digital radio source.

[4] Displayed only when "DSP Set" is set to "Through".

[5] Audio file source only

### 5 Select a value using [Control] knob.

#### Exiting from the Function setting mode

Press and hold [Q/⏪].

#### When you selected "iPod" for "Preset Equalizer"

- When you selected "iPod" for "Preset Equalizer", next select an equalizer curve. Select a desired equalizer curve using [Control] knob from among 22 equalizer curves displayed after you selected "iPod".

## 5-2. Manual equalizer control

You can adjust the equalizer curve manually.

### 1 Press [SRC] to select a source other than Standby ("STANDBY").

Refer to <Source selection> (page 14).

### 2 Press [Control] knob.

Enters the Function setting mode.

### 3 Select "Audio Control" > "Manual Equalizer" using [Control] knob.

For how to use [Control] knob, refer to <3-3. How to select the item> (page 13).

### 4 Select a equalizer control item using [Control] knob.

Display	Description	Range
"Gain"	Adjust the gain of each band.	-9 - 0 - +9 dB
"Q Factor"	Adjust Q of each band.	1.35/ 1.50/ 2.00
"Bass EXT"	Adjust the gain of lower frequencies than 62.5 Hz to the level equivalent to 62.5 Hz.	"OFF"/ "ON"

(Colored text: Factory setting)

When "Bass EXT" and "Q Factor" are selected, skip step 5.

### 5 Select a Band using [Control] knob.

"BAND1"; 62.5 Hz, "BAND2"; 100 Hz,  
"BAND3"; 160 Hz, "BAND4"; 250 Hz,  
"BAND5"; 400 Hz, "BAND6"; 630 Hz,  
"BAND7"; 1 kHz, "BAND8"; 1.6 kHz,  
"BAND9"; 2.5 kHz, "BAND10"; 4 kHz,  
"BAND11"; 6.3 kHz, "BAND12"; 10 kHz,  
"BAND13"; 16kHz

### 6 Select a value using [Control] knob.

#### Exiting from the Function setting mode

Press and hold [Q/↵].

#### When the "Manual Equalizer" item is not displayed

- This function is not available when "iPod" is selected for "Preset Equalizer".

## 5-3. Car type selection

You can compensate the delay of the sound arrival time by selecting your environment from the car types.

### 1 Press [SRC] to select a source other than Standby ("STANDBY").

Refer to <Source selection> (page 14).

### 2 Press [Control] knob.

Enters the Function setting mode.

### 3 Select "Audio Control" > "Pro Setup" > "Car Type" using [Control] knob.

For how to use [Control] knob, refer to <3-3. How to select the item> (page 13).

### 4 Select a car type using [Control] knob.

Display	Car type
"OFF"	Not compensating.
"Compact"	Compact car
"Sedan"	Sedan
"Wagon"	Station wagon
"Minivan"	Minivan
"SUV"	Sport-utility vehicle
"Passenger Van"	Passenger van

#### Exiting from the Function setting mode

Press and hold [Q/↵].

#### To set the delay time finely

- You can compensate the distances in more details by using <5-7. Delay time control> (page 21) function.

# DSP settings (KDC-BT73DAB, KDC-BT53U)

## 5-4. Speaker setting

The speaker X'Over is automatically set when the position and size of each speaker are selected from the following items.

**1 Press [SRC] to select a source other than Standby ("STANDBY").**

Refer to <Source selection> (page 14).

**2 Press [Control] knob.**

Enters the Function setting mode.

**3 Select "Audio Control" > "Pro Setup" > "Speaker Setting" using [Control] knob.**

For how to use [Control] knob, refer to <3-3. How to select the item> (page 13).

**4 Select a speaker type using [Control] knob.**

Speaker type	Setting item	Setting value
"Front"	Front speaker location	"Door", "On Dash", "Under Dash"
	"SIZE"	Front speaker size "O.E.M.", "8cm", "10cm", "12cm", "13cm", "16cm", "17cm", "18cm", "4x6", "5x7", "6x8", "6x9", "7x10"
	"TW"	Tweeter size "None", "Small", "Medium", "Large"
"Rear"	Rear speaker location	"Door", "Rear Deck" ("2nd Row", "3rd Row"[1])
	"SIZE"	Rear speaker size "None", "O.E.M.", "8cm", "10cm", "12cm", "13cm", "16cm", "17cm", "18cm", "4x6", "5x7", "6x8", "6x9", "7x10"
"SubWoofer"	"SIZE"	Speaker Size Subwoofer "None", "16cm", "20cm", "25cm", "30cm", "38cm Over"

(Colored text: Factory setting)

[1] Value set when "Minivan" or "Passenger Van" is selected as described in <5-3. Car type selection> (page 19).

**5 Select a setting item using [Control] knob.**

**6 Select a setting value using [Control] knob.**

**Exiting from the Function setting mode**

Press and hold [Q/↵].

## 5-5. X'Over setting

Fine adjusting the following setting values corresponding to the X'Over values set in the section <5-4. Speaker setting> (page 20).

**1 Press [SRC] to select a source other than Standby ("STANDBY").**

Refer to <Source selection> (page 14).

**2 Press [Control] knob.**

Enters the Function setting mode.

**3 Select "Audio Control" > "Pro Setup" > "X'Over" using [Control] knob.**

For how to use [Control] knob, refer to <3-3. How to select the item> (page 13).

**4 Select a speaker type using [Control] knob.**

Speaker type	Setting item	Setting value
"Front"	"FC"	Front high pass filter Through, 30, 40, 50, 60, 70, 80, 90, 100, 120, 150, 180, 220, 250 Hz
	"SLOPE"[1]	Front high pass slope -6, -12, -18, -24 dB/Oct
	"GAIN"	Front gain -8, -7, -6, -5, -4, -3, -2, -1, 0 dB
"Rear"	"FC"	Rear high pass filter Through, 30, 40, 50, 60, 70, 80, 90, 100, 120, 150, 180, 220, 250 Hz
	"SLOPE"[1]	Rear high pass slope -6, -12, -18, -24 dB/Oct
	"GAIN"	Rear Gain -8, -7, -6, -5, -4, -3, -2, -1, 0 dB
"SubWoofer"	"FC"	Subwoofer low pass filter 30, 40, 50, 60, 70, 80, 90, 100, 120, 150, 180, 220, 250, Through Hz
	"SLOPE"[1]	Subwoofer slope -6, -12, -18, -24 dB/Oct
	"GAIN"	Subwoofer gain -8, -7, -6, -5, -4, -3, -2, -1, 0 dB
	"PHASE"	Subwoofer phase "REV" (180°)/ "NML" (0°)
"Tweeter"	"FC"	Shelving filter 1, 1.6, 2.5, 4, 5, 6.3, 8, 10, 12.5 kHz
	"Volume"	Tweete volume -8, -7, -6, -5, -4, -3, -2, -1, 0 dB

(Colored text: Factory setting)

[1] Displayed only when "FC" is set to "30" - "250".

**5 Select a setting item using [Control] knob.**

**6 Select a setting value using [Control] knob.**

**Exiting from the Function setting mode**

Press and hold [Q/↵].

## 5-6. Listening position setting

You can adjust sound localization according to the listening position.

### 1 Press [SRC] to select a source other than Standby ("STANDBY").

Refer to <Source selection> (page 14).

### 2 Press [Control] knob.

Enters the Function setting mode.

### 3 Select "Audio Control" > "Pro Setup" > "DTA Settings" > "Preset Position" using [Control] knob.

For how to use [Control] knob, refer to <3-3. How to select the item> (page 13).

### 4 Select a listening position using [Control] knob.

Display	Compensation seat
"All"	Not compensating.
"Front R"	Front Right seat
"Front L"	Front Left seat
"Front All"	Front seat

### Exiting from the Function setting mode

Press and hold [Q/↵].

## 5-7. Delay time control

Adjusting fine tuning of the speaker position compensation value specified at <5-3. Car type selection> (page 19).

### Preparation for setting

- If you specify the distance from the center of the currently set listening position to every speaker, the delay time will be automatically computed and set.
  - Determine the center of the currently set listening position as the reference point (• in the illustration shown below).
  - Measure the distances from the reference point to the speakers.
  - Calculate the differences between the distance of the furthest speaker and other speakers.
  - Input the differences calculated in step 3 for individual speakers.
  - Adjust gain for individual speakers. A sound image will be shifted to the speaker with increased gain.

**Example:** When "Front" is selected as the listening position (<5-6. Listening position setting> (page 21)).

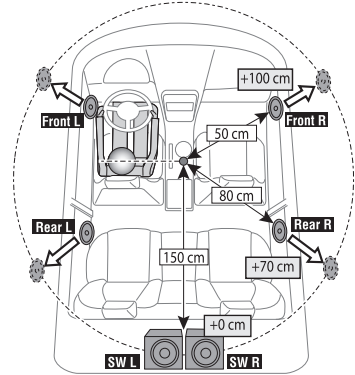

### 1 Press [SRC] to select a source other than Standby ("STANDBY").

Refer to <Source selection> (page 14).

### 2 Press [Control] knob.

Enters the Function setting mode.

### 3 Select "Audio Control" > "Pro Setup" > "DTA Settings" > "DTA" using [Control] knob.

For how to use [Control] knob, refer to <3-3. How to select the item> (page 13).

### 4 Select a speaker using [Control] knob.

Speaker	Display	Range
Front Left speaker	"FrontL"	0 – 610 cm
Front Right speaker	"FrontR"	0 – 610 cm
Rear Left speaker	"RearL"	0 – 610 cm

## DSP settings (KDC-BT73DAB, KDC-BT53U)

Rear Right speaker	"RearR"	0 – 610 cm
Subwoofer Left	"SW L"	0 – 610 cm
Subwoofer Right	"SW R"	0 – 610 cm

(Colored text: Factory setting)

### 5 Select a value using [Control] knob.

#### Exiting from the Function setting mode

Press and hold [Q/↵].

## 5-8. Channel level fine adjustments

After DTA compensation, you can finely adjust the unsatisfactory speaker volume of respective speaker.

### 1 Press [SRC] to select a source other than Standby ("STANDBY").

Refer to <Source selection> (page 14).

### 2 Press [Control] knob.

Enters the Function setting mode.

### 3 Select "Audio Control" > "Pro Setup" > "DTA Settings" > "Channel Level" using [Control] knob.

For how to use [Control] knob, refer to <3-3. How to select the item> (page 13).

### 4 Select a speaker using [Control] knob.

Speaker	Display	Range
Front Left speaker	"Front" "L"	-8 – 0 dB
Front Right speaker	"Front" "R"	-8 – 0 dB
Rear Left speaker	"Rear" "L"	-8 – 0 dB
Rear Right speaker	"Rear" "R"	-8 – 0 dB
Subwoofer Left	"SW" "L"	-8 – 0 dB
Subwoofer Right	"SW" "R"	-8 – 0 dB

(Colored text: Factory setting)

### 5 Select a value using [Control] knob.

#### Exiting from the Function setting mode

Press and hold [Q/↵].

## **5-9. Resetting of DTA Settings**

---

You can reset the DTA-compensated values to the factory settings.

**1 Press [SRC] to select a source other than Standby ("STANDBY").**

Refer to [<Source selection> \(page 14\)](#).

**2 Press [Control] knob.**

Enters the Function setting mode.

**3 Select "Audio Control" > "Pro Setup" > "DTA Settings" > "Reset DTA Setting" using [Control] knob.**

For how to use [Control] knob, refer to [<3-3. How to select the item> \(page 13\)](#).

**4 Select "YES" using [Control] knob.**

***Exiting from the Function setting mode***

Press and hold [Q/↵].

# DSP settings (KDC-BT73DAB, KDC-BT53U)

## 5-10. DSP preset

---

You can register the values set the DSP control items.

### 1 Set the DSP control items

Refer to the following operations to setup the Sound Control.

- "SubWoofers Level" of <5-1. Audio control> (page 18)
- <5-2. Manual equalizer control> (page 19)
- <5-3. Car type selection> (page 19)
- <5-4. Speaker setting> (page 20)
- <5-5. X'Over setting> (page 20)
- <5-6. Listening position setting> (page 21)
- <5-7. Delay time control> (page 21)
- <5-8. Channel level fine adjustments> (page 22)

### 2 Press [Control] knob.

Enters the Function setting mode.

### 3 Select "Audio Control" > "Pro Setup" > "Audio Preset" > "Memory" using [Control] knob.

For how to use [Control] knob, refer to <3-3. How to select the item> (page 13).

### 4 Select a memory number ("Memory 1" or "Memory 2") using [Control] knob.

### 5 Select "YES" using [Control] knob.

"Memory Completed" appears.

### **Exiting from the Function setting mode**

Press and hold [Q/↵].

#### **When reset**

- When this unit is reset, all setting values stored in "Memory 1" are applied to the source.

## 5-11. DSP preset recall

---

You can recall the DSP control items registered to the <5-10. DSP preset> (page 24).

### 1 Press [SRC] to select a recall source.

Refer to <Source selection> (page 14).

### 2 Press [Control] knob.

Enters the Function setting mode.

### 3 Select "Audio Control" > "Pro Setup" > "Audio Preset" > "Recall" using [Control] knob.

For how to use [Control] knob, refer to <3-3. How to select the item> (page 13).

### 4 Select a recall memory number ("Recall 1" or "Recall 2") using [Control] knob.

### 5 Select "YES" using [Control] knob.

"Recall Completed" appears.

### **Exiting from the Function setting mode**

Press and hold [Q/↵].





## 6. Listen to the iPod

### 6-1. Models of iPods/iPhones that can be connected to this unit

Made for

- iPod nano (6th generation)
  - iPod nano (5th generation)
  - iPod nano (4th generation)
  - iPod nano (3rd generation)
  - iPod nano (2nd generation)
  - iPod nano (1st generation)
  - iPod with video
  - iPod classic
  - iPod touch (4th generation)
  - iPod touch (3rd generation)
  - iPod touch (2nd generation)
  - iPod touch (1st generation)
  - iPhone 4S
  - iPhone 4
  - iPhone 3GS
  - iPhone 3G
  - iPhone
- For information on the compatibility with iPod/iPhone software, visit [www.kenwood.com/cs/ce/ipod/](http://www.kenwood.com/cs/ce/ipod/).
  - Types of available control vary depending on the type of connected iPod. Visit [www.kenwood.com/cs/ce/ipod/](http://www.kenwood.com/cs/ce/ipod/) for further details.
  - The word "iPod" appearing in this manual indicates the iPod or the iPhone connected with the iPod connection cable (optional accessory).
  - Refer to the web site for connectable iPods and iPod connection cables.  
[www.kenwood.com/cs/ce/ipod/](http://www.kenwood.com/cs/ce/ipod/)

#### Notes

- If you start playback after connecting the iPod, the music that was playing on the iPod is played first. In this case, "RESUMING" appears without displaying a folder name, etc. Changing the browse item will display a correct title, etc.
- You cannot operate the iPod if "KENWOOD" or "✓" appears on the iPod.

### 6-2. Playing music

#### Playing a iPod

Connect the iPod to the USB terminal using the KCA-iP102 (optional accessory).

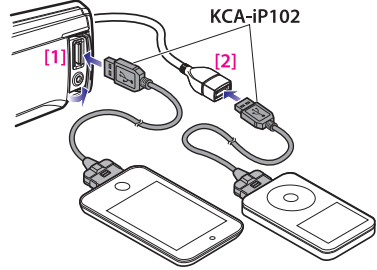

[1] Front USB terminal

[2] Rear USB terminal

You can connect the iPod to either one of the USB terminals provided at the front and rear of this unit. If you connect a device to the USB terminal provided at the rear, the "REAR USB" indicator stays lit.

When it is connected, the source is switched automatically and playback starts.

#### Selecting a song

Press [**◀◀**] or [**▶▶**] button.

#### Fast-forwarding or fast-backwarding a song

Press and hold [**◀◀**] or [**▶▶**].

#### Pause and play a song

Press and hold [**Q/↵**].

#### Removing iPod

Switch the source to a device other than iPod and Aha Radio, and then remove the iPod.

**Data contained in the iPod may be damaged if you remove it when it is used as the active source.**

#### When playback of iPod touch or iPhone does not start

- If an unsupported application has started when connecting iPod touch or iPhone, "APP & iPod Mode" appears and sometimes playback does not start. In this case, APP & iPod Mode is set to "OFF". Refer to <6-9. App & iPod mode setting> (page 30).

## 6-3. Music search

You can search for the song you want to play.

### 1 Press [Q/↵].

"MUSICSEARCH" appears and enters the Music search mode.

### 2 Search for a song

Operation type	Operation
Movement between items	Turn [Control] knob.
Selection of item	Press [Control] knob.
Return to previous item	Press [Q/↵].
Return to Top menu	Press and hold [⏪].

### Exiting from the Music search mode

Press and hold [Q/↵].

#### Undisplayable titles

- If no characters included in a song name can be displayed, the browse item name and digits are displayed.

Items	Display
Playlists	"PLIST****"
Artists	"ART****"
Albums	"ALB****"
Songs	"PRGM****"
Podcasts	"PDC****"
Genres	"GEN****"
Composers	"COM****"

## 6-4. Alphabet search

You can select an alphabetic character from the list in the browse item (artist, album, etc.) currently selected.

#### When the KDC-5057SD is used

- The KDC-5057SD allows you to enter the Alphabet search mode by pressing [A to Z]s instead of executing the following steps 2 and 3.

### 1 Press [Q/↵].

"MUSICSEARCH" appears and enters the Music search mode.

### 2 Press and hold [Control] knob.

Enter the Search select mode

### 3 Select "Alphabet Search" using [Control] knob.

### 4 Select a character using [Control] knob.

Return to the Music search mode.

### Exiting from the Alphabet search mode

Press and hold [Q/↵].

#### Notes on alphabet search

- Turning [Control] knob fast in the Music search mode allows you to enter the alphabet search mode.
- The time of Alphabet search may become long depending on the number of items (songs) in iPod.
- To search for a character other than A to Z and 1, enter "\*".
- If the first character string begins with an article "a", "an", or "the" in the alphabet search mode, it is searched for in defiance of the article.

# Listen to the iPod

## 6-5. Direct search

You can search for music by selecting a browse item and an alphabetic character(s).

### 1 Press [Q/↵].

"MUSICSEARCH" appears and enters the Music search mode.

### 2 Press and hold [Control] knob.

Enter the Search select mode

### 3 Select "Direct Search" using [Control] knob.

### 4 Select browse item using [Control] knob.

Display	Browse item
"PLAYLISTS"	Playlists
"ARTISTS"	Artists
"ALBUMS"	Albums
"SONGS"	Songs
"PODCASTS"	Podcasts
"GENRES"	Genres
"COMPOSERS"	Composers

### 5 Select select a character(s) using [Control] knob.

You can select up to three characters.

### 6 Select "DONE" using [Control] knob.

A search result list is displayed.

### 7 Select music using [Control] knob.

#### **Exiting from the Music search mode**

Press and hold [Q/↵].

## 6-6. Skip search

You can search for a song by skipping songs at the set skip search ratio (the ratio of the number of songs to skip to the total number of songs in the selected list)

### 1 Press [Q/↵].

"MUSICSEARCH" appears and enters the Music search mode.

### 2 Press and hold [Control] knob.

Enter the Search select mode

### 3 Select "Skip Search" using [Control] knob.

### 4 Search for music

Operation type	Operation
Movement between items	Turn [Control] knob.
Skip Search	Press [▲] or [▼].
Selection of item	Press [Control] knob.
Setting of skip search ratio	Press [◀◀] or [▶▶].

#### **Exiting from the Music search mode**

Press and hold [Q/↵].

#### **Skip search ratio setting**

- You can also set the skip search ratio in the Function setting mode. Refer to <6-7. Skip search ratio setting> (page 29).

## 6-7. Skip search ratio setting

You can change the ratio of skip performed as mentioned in <6-6. Skip search> (page 28).

### 1 Press [SRC] to select an iPod ("iPod") source.

Refer to <Source selection> (page 14).

### 2 Press [Control] knob.

Enters the Function setting mode.

### 3 Select "Settings" > "Skip Search" using [Control] knob.

For how to use [Control] knob, refer to <3-3. How to select the item> (page 13).

### 4 Select a ratio (0.5%, 1%, 5%, 10%) using [Control] knob.

Returns to the previous item.

#### **Exiting from the Function setting mode**

Press and hold [Q/↵].

## 6-8. Playback mode

You can select a playback mode, such as Random play and Repeat play.

### 1 Press [SRC] to select an iPod ("iPod") source.

Refer to <Source selection> (page 14).

### 2 Press [Control] knob.

Enters the Function setting mode.

### 3 Select "Play Mode" using [Control] knob.

For how to use [Control] knob, refer to <3-3. How to select the item> (page 13).

### 4 Select a playback mode function using [Control] knob.

Display	Description
"Folder Random"	When set to "ON", plays the songs in the folder randomly. (Music only) <input checked="" type="checkbox"/> (ON) / <input type="checkbox"/> (OFF)
"All Random"	When set to "ON", plays all songs in the iPod randomly. (Music only) <input checked="" type="checkbox"/> (ON) / <input type="checkbox"/> (OFF)
"File Repeat"	When set to "ON", plays the song repeatedly. <input checked="" type="checkbox"/> (ON) / <input type="checkbox"/> (OFF)

### 5 Press [Control] knob.

The setting is changed.

#### **Exiting from the Function setting mode**

Press and hold [Q/↵].

# Listen to the iPod

## 6-9. App & iPod mode setting

---

You can select a music from iPod when App & iPod mode is set to ON.

**1 Press [SRC] and select an iPod ("iPod") source using [Control] knob.**

Refer to [<Source selection> \(page 14\)](#).

**2 Press [Control] knob.**

Enters the Function setting mode.

**3 Select "APP & iPod Mode" using [Control] knob.**

For how to use [Control] knob, refer to [<3-3. How to select the item> \(page 13\)](#).

Selecting "APP & iPod Mode" item each time switching between On and Off.

**Exiting from the Function setting mode**

Press and hold [Q/↵].

**Operation performed when "APP & iPod Mode" is set to "ON"**

- When "APP & iPod Mode" is set to "ON", this unit can control only the "Pause and play", "Selecting a song", and "Fast Forward or Fast Backward of the Song" functions.



## 7. Aha Radio (KDC-BT73DAB, KDC-BT53U)

### 7-1. Requirements Aha™

Requirements for listening to the Aha™ are as follows:

#### **iPhone or iPod touch**

- Use an Apple iPhone or iPod touch running iOS4 or later.
- Search for "aha" in the Apple iTunes App Store to find and install the most current version of the Aha™ application on your device.
- iPhone/ iPod touch connected to this unit with a KCA-iP102 (optional accessory).

#### **Android™**

- Use Android OS 2.2 or later.
- Download the Aha™ application to your smartphone from the Google Play.
- Bluetooth must be built in and the following profiles must be supported.
  - SPP (Serial Port Profile)
  - A2DP (Advanced Audio Distribution Profile)

#### **Notes**

- In the application on your device, log in and create a free account with Aha.
- Internet connection by LTE, 3G, EDGE, or WiFi.
- Because Aha™ is a third-party service, the specifications are subject to change without prior notice. Accordingly, compatibility may be impaired or some or all of the services may become unavailable.
- Some Aha™ functionality cannot be operated from this unit.

### 7-2. Listening to the Aha Radio

#### **Android**

- You need to register your cell phone before using it with this unit. See <13-2. Registering a Bluetooth device> (page 62).
- Disconnect the iPhone or iPod touch.

#### **1 Connect the Android smartphone via Bluetooth.**

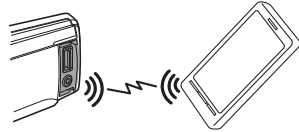

#### **2 Open the Aha Radio application on your device.**

#### **3 Press [SRC] to select an Aha Radio ("aha") source.**

Refer to <Source selection> (page 14).

#### **iPhone or iPod touch**

#### **1 Open the Aha Radio application on your device.**

#### **2 Connect the iPod to the USB terminal using the KCA-iP102 (optional accessory).**

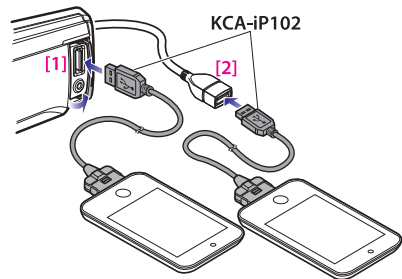

[1] Front USB terminal

[2] Rear USB terminal

#### **3 Press [SRC] to select an Aha Radio ("aha(FRONT)" or "aha(REAR)") source.**

Refer to <Source selection> (page 14).



### 7-3. Basic operations

---

#### ***Pause and play a content***

Press and hold [Q/⏮].

#### ***Selecting a content***

Press [◀◀] or [▶▶] button.

#### ***Forward 30 seconds a content***

Press and hold [▶▶].

#### ***Backward 15 seconds a content***

Press and hold [◀◀].

#### ***"Likes" current content***

Press [▲] button.

To unvote, press the button again.

#### ***"Dislikes" current content***

Press [▼] button.

To unvote, press the button again.

### 7-4. Station search

---

You can select the station you want to listen to from your station list.

#### **1 Press [Q/⏮].**

"Station List" appears and enter the Station List mode.

#### **2 Select a station using [Control] knob.**

For how to use [Control] knob, refer to <3-3. [How to select the item> \(page 13\).](#)

#### **3 Select a content using [Control] knob.**

# Aha Radio (KDC-BT73DAB, KDC-BT53U)

## 7-5. Calling a number in the content

You can call the phone number obtained from the content from a smartphone connected to this unit via Bluetooth.

**1 Press and hold [Control] knob.**

"Make a call" appears.

**2 Press [Control] knob.**

Makes a call.

**Canceling the call**

Press [Q/↵].

## 7-6. Aha source control

You can turn on/off the aha source.

**1 Press [SRC] to select a Standby ("STANDBY").**

Refer to <Source selection> (page 14).

**2 Press [Control] knob.**

Enters the Function setting mode.

**3 Select "Initial Settings" > "aha Source" using [Control] knob.**

For how to use [Control] knob, refer to <3-3. How to select the item> (page 13).

**4 Select a aha source control method using [Control] knob.**

"ON": Turns on the aha source.

"OFF": Turns off the aha source.

**Exiting from the Function setting mode**

Press and hold [Q/↵].



## 8. Listen to the CD/ Audio file

### 8-1. Playing music

#### Playing a disc

Open the Disc slot cover upward.  
Insert a disc in the Disc slot.

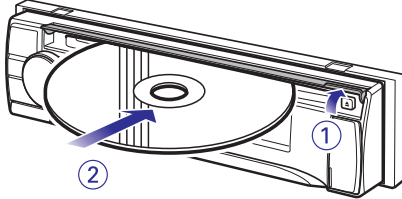

When it is inserted, the source is switched automatically and playback starts.  
Close the Disc slot cover.

#### Playing a USB device

Connect a USB device to the USB terminal.

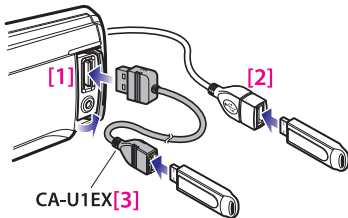

- [1] Front USB terminal
- [2] Rear USB terminal
- [3] optional accessory

You can connect the iPod or USB device to either one of the USB terminals provided at the front and rear of this unit.

When it is connected, the source is switched automatically and playback starts.

#### Playing a SD card (Function of KDC-5057SD)

Press the Release button and detach the Faceplate. (Refer to [<Detaching/ Attaching the faceplate> \(page 13\)](#))

Hold the SD card with the label side up and the notched section on the right, and insert it into the slot until it clicks.

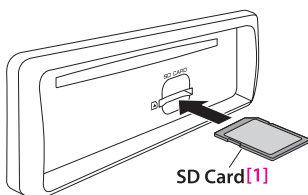

[1] commercially available

Attaching the Faceplate.

#### Selecting an audio file folder

Press [▲] or [▼] button.

#### Selecting a song (track or file)

Press [◀◀] or [▶▶].

#### Fast-forwarding or fast-backwarding a song (track or file)

Press and hold [◀◀] or [▶▶].

#### Pause and play a song (track or file)

Press and hold [Q/⏮].

#### Removing disc

Open the Disc slot cover upward.  
Press [▲].

#### Removing USB device

Press [SRC] to switch the source to a device other than USB, and then remove the USB device.

Data contained in the USB device may be damaged if you remove it when it is used as the active source.

#### Removing SD card (Function of KDC-5057SD)

Press the Release button and detach the Faceplate. (Refer to [<Detaching/ Attaching the faceplate> \(page 13\)](#))

Push the SD card until it clicks and then remove your finger from the card.

The card pops up so that you can pull it out with your fingers.

Attaching the Faceplate.

## 8-2. Music search

You can select the music you want to listen to from the device or media being played now.

### 1 Press [Q/↵].

"MUSICSEARCH" appears, and the Music search mode is selected.

### 2 Search for music

#### Audio file

Operation type	Operation
Movement between folders/files	Turn [Control] knob.
Selection of folder/file	Press [Control] knob.
Return to previous folder	Press [Q/↵].
Return to root folder	Press and hold [⏪].
Cancellation of Music search mode	Press and hold [Q/↵].

🎵 indicator: Audio file

📁 indicator: Folder

#### CD source

Operation type	Operation
Movement between track	Turn [Control] knob.
Selection of track	Press [Control] knob.
Return to first track	Press and hold [⏪].
Cancellation of Music search mode	Press [Q/↵].

#### When two USB memories are connected

- When two USB memories are connected, you can search for a song in both USB memories. When database information is added using KENWOOD Music Editor (<8-9. About "KENWOOD Music Editor Light" and "KENWOOD Music Control"> (page 40)), you can search a song in only one USB memory.

## 8-3. Skip search

(Music Editor media <8-9. About "KENWOOD Music Editor Light" and "KENWOOD Music Control"> (page 40))

You can search for a song by skipping songs at the set skip search ratio (the ratio of the number of songs to skip to the total number of songs in the selected list).

### 1 Press [Q/↵].

"MUSICSEARCH" appears, and the Music search mode is selected.

### 2 Press and hold [Control] knob.

Enter the Search select mode

### 3 Select "Skip Search" using [Control] knob.

### 4 Search for music

Operation type	Operation
Movement between items	Turn [Control] knob.
Skip search	Press [▲] or [▼].
Selection of item	Press [Control] knob.
Setting of skip search ratio	Press [⏪] or [▶].

#### Exiting from the Music search mode

Press and hold [Q/↵].

#### Skip search ratio setting

- You can also set the skip search ratio in the Function setting mode. Refer to <8-4. Skip search ratio setting> (page 38).

# Listen to the CD/ Audio file

## 8-4. Skip search ratio setting

(Music Editor media <8-9. About "KENWOOD Music Editor Light" and "KENWOOD Music Control"> (page 40))

You can change the ratio of skip performed as mentioned in <8-3. Skip search> (page 37).

**1 Press [SRC] to select a USB/ SD ("USB"/ "SD") source.**

Refer to <Source selection> (page 14).

**2 Press [Control] knob.**

Enters the Function setting mode.

**3 Select "Settings" > "Skip Search" using [Control] knob.**

For how to use [Control] knob, refer to <3-3. How to select the item> (page 13).

**4 Select a ratio using [Control] knob.**

Returns to the previous item.

### Exiting from the Function setting mode

Press and hold [Q/↵].

## 8-5. Playback mode

You can select a playback mode, such as Random play and Repeat play.

**1 Press [SRC] to select a CD/ USB/ SD ("CD"/ "USB"/ "SD") source.**

Refer to <Source selection> (page 14).

**2 Press [Control] knob.**

Enters the Function setting mode.

**3 Select "Play Mode" using [Control] knob.**

For how to use [Control] knob, refer to <3-3. How to select the item> (page 13).

**4 Select a playback mode function using [Control] knob.**

Display	Description
"Disc Random" (CD)/ "Folder Random" (Audio file)	When set to "ON", plays the songs in the CD/ folder randomly. <input checked="" type="checkbox"/> (ON) / <input type="checkbox"/> (OFF)
"All Random" (Audio file)	When set to "ON", plays all songs in the disc/ USB/SD randomly. <input checked="" type="checkbox"/> (ON) / <input type="checkbox"/> (OFF)
"Track Repeat" (CD)/ "File Repeat" (Audio file)	When set to "ON", plays the selected song repeatedly. <input checked="" type="checkbox"/> (ON) / <input type="checkbox"/> (OFF)
"Folder Repeat" (Audio file <sup>[1]</sup> )	When set to "ON", plays the songs in the folder repeatedly. <input checked="" type="checkbox"/> (ON) / <input type="checkbox"/> (OFF)

[1] Except the Music Editor media

**5 Press [Control] knob.**

The setting is changed.

### Exiting from the Function setting mode

Press and hold [Q/↵].

## 8-6. About the Audio file

### • Playable Audio files

AAC-LC (.m4a), MP3 (.mp3), WMA (.wma), WAV (.wav) of USB device/ SD card

### • Playable disc media

CD-R/RW/ROM

### • Playable disc file formats

ISO 9660 Level 1/2, Joliet, Long file name.

### • Playable USB devices

USB mass storage class

### • Playable USB device and SD card file system

FAT12, FAT16, FAT32

Even if the audio files comply with the standards listed above, playback may be impossible depending on the type or condition of the medium or device.

### • Playback order of the Audio files

In the example of folder/file tree shown below, files are played in the order of number from (1) to (6).

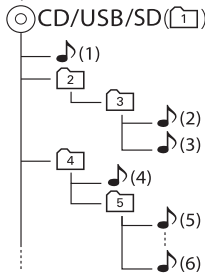

📁: folder

🎵: Audio file

For the online manual describing audio files, visit [www.kenwood.com/cs/ce/audiofile/](http://www.kenwood.com/cs/ce/audiofile/). In this online manual, detailed information and notes which are not provided in this manual are provided. Make sure to read through the online manual as well.

### What is a USB device?

- In this manual, the term "USB device" indicates a flash memory or digital audio player which has a USB terminal.

## 8-7. About the USB device

- When the USB device is connected to this unit, it is charged when this unit is powered.
- Install the USB device in the place where it will not prevent you from driving your vehicle properly.
- You cannot connect a USB device via a USB hub or multi card reader.
- Save backups of the audio files used with this unit. The files can be erased depending on the operating condition of the USB device.  
We shall not be liable for any damage arising out of erasure of the stored data.
- No USB device comes with this unit. You need to purchase a commercially available USB device.
- When connecting the USB device, use of the CA-U1EX (option) is recommended.
- Normal playback is not guaranteed when a cable other than the USB compatible cable is used. Connecting a cable whose total length is longer than 4 m can result in abnormal playback.

## Listen to the CD/ Audio file

### 8-8. About SD card

---

- This unit is capable of playback of SD/SDHC memory cards complying with the SD or SDHC standard.  
SD card (≤2 GB), SDHC card (≤32 GB)
- A special adapter is required to use a miniSD card, miniSDHC card, microSD card or microSDHC card.
- The MultiMedia Card (MMC) cannot be used.
- Data recorded in the SD audio format cannot be played back.

### 8-9. About "KENWOOD Music Editor Light" and "KENWOOD Music Control"

---

- This unit supports the PC application "KENWOOD Music Editor Light" (hereinafter "KME-Light"), and Android™ application "KENWOOD Music Control" (hereinafter "KMC").
- When you use the audio file with database information added by the "KENWOOD Music Editor Light" or "KENWOOD Music Control", you can search for a file by title, album or artist name using Music Search.
- "KENWOOD Music Editor Light" and "KENWOOD Music Control" are available from the following web site: [www.kenwood.com/cs/ce/](http://www.kenwood.com/cs/ce/)



## 8-10. About the discs used with this unit

---

- This unit can only play the CDs with 
- The following discs cannot be used:
  - A discs that is not round
  - A discs with coloring on the recording surface or a disc that is dirty
  - A recordable/rewritable disc that has not been finalized (For the finalization process, refer to the instruction manual that came with your disc writing software or your disc recorder.)
  - An 8 cm (3 inch) disc (An attempt to insert using an adapter can cause malfunction.)

## 8-11. Handling discs

---

- Do not touch the recording surface of the disc.
- Do not stick tape etc. on the disc, or use a disc with tape stuck on it.
- Do not use any accessories for the disc.
- Do not use any solvents to clean discs. Use a dry silicon or soft cloth.
- Clean the disc by moving the cloth outward from the center of the disc.
- When removing a disc from this unit, pull it out horizontally.
- If the center hole or outside rim of a disc has burrs, remove them before inserting a disc.

## 9. Listen to the tuner

### 9-1. Listening to the radio

#### **Selecting a tuner source**

Press [SRC] to select a Tuner ("TUNER") source.

Refer to <Source selection> (page 14).

#### **Selecting a band (FM or AM)**

Press [▲].

#### **Selecting a station**

Press [◀◀] or [▶▶].

The seek mode can be changed. Refer to <Selecting a Seek mode> (refer to below), <9-5. Tuner setting> (page 44).

#### **Selecting a Seek mode**

Press [▼].

Display	Operation
"Auto1"	Automatic search for a station.
"Auto2"	Search in order of the stations in the preset memory.
"Manual"	Normal manual tuning.

### 9-2. Station preset memory

You can store a station in the memory.

**1 Press [◀◀] or [▶▶] to select the channel.**

**2 Press [Q/↵].**

Enter the Preset mode.

**3 Turn [Control] knob to select a memory number (FM: "1" – "18", AM: "1" – "6").**

**4 Press and hold [Control] knob.**

#### **Exiting from the Preset memory mode**

Press and hold [Q/↵].

#### **About the Mix Station preset mode**

- If you press [Q/↵] twice in step 2, the Mix Station preset mode is selected with "Mixed Preset List" displayed. In this mode, different bands and tuner sources (FM, AM, Digital Radio etc.) can be saved in the same preset layer, which allows you to recall a desired station without switching between bands and/or tuner sources. Maximum of 6 stations can be preset in the Mix Station preset mode. Once the Mix Station preset mode is set, you can enter the same mode by just pressing [Q/↵] once in step 2. Pressing [Q/↵] twice allows you to return to the normal Station preset mode.

### 9-3. Auto memory

---

You can register 18 (FM)/ 6 (AM) stations with good reception automatically.

**1 Press [SRC] to select a Tuner ("TUNER") source.**

Refer to [<Source selection>](#) (page 14).

**2 Press [▲] to select a band.**

**3 Press [Control] knob.**

Enters the Function setting mode.

**4 Select "Settings" > "Auto Memory" using [Control] knob.**

For how to use [Control] knob, refer to [<3-3. How to select the item>](#) (page 13).

**5 Select "YES" using [Control] knob.**

When 18 (FM)/ 6 (AM) stations that can be received are stored in the memory, the process in this mode is completed.

***Exiting from the Function setting mode***

Press and hold [Q/↵].

### 9-4. Recall preset station

---

Recall the stations in the memory.

**1 Press [▲] to select a band.**

**2 Press [Q/↵].**

Enter the Preset mode.

**3 Select a memory number (FM: "1" – "18", AM: "1" – "6") using [Control] knob.**

# Listen to the tuner

## 9-5. Tuner setting

You can set up the tuner.

### 1 Press [SRC] to select a Tuner ("TUNER") source.

Refer to <Source selection> (page 14).

### 2 Press [Control] knob.

Enters the Function setting mode.

### 3 Select "Settings" using [Control] knob.

For how to use [Control] knob, refer to <3-3. How to select the item> (page 13).

### 4 Select a Tuner setting item using [Control] knob.

Display	Description
"Local Seek"	Only stations whose reception is good are searched in auto seek tuning. (FM only) <b>"ON" / "OFF"</b>
"Seek Mode"	Sets the seek mode. <b>"Auto1"</b> : Automatic search for a station. <b>"Auto2"</b> : Search in order of the stations in the preset memory. <b>"Manual"</b> : Normal manual tuning.
"MONO"	You can reduce the noise when stereo broadcasts are received as monaural. <b>"ON" / "OFF"</b>
"TI"	Switches to the traffic information automatically when the traffic bulletin starts. <b>"ON" / "OFF"</b>
"News Interrupt"	Automatically receives news bulletin when it starts. Set the time during which interrupt is to be disabled after start of another news bulletin. Changing "00MIN" to "90MIN" turns this function ON. If news bulletin starts when this function is ON, "NEWS" appears and news is received. If "20MIN" is has been set, reception of another news bulletin will not start for 20 minutes. The news bulletin volume is the same level that was set for Traffic Information. <b>"OFF" / "00MIN" – "90MIN"</b>
"AF"	When the reception is poor, automatically alternate to another frequency broadcasting the same program in the same Radio data system network with better reception. <b>"ON" / "OFF"</b>
"Regional"	Sets whether to switch to the station only in the specific region using the "AF" control. <b>"ON" / "OFF"</b>
"Auto TP Seek"	When traffic information station reception is poor, automatically searches for a station that can be received better. <b>"ON" / "OFF"</b>

(Colored text: Factory setting)

### 5 Select a setting using [Control] knob.

Returns to the previous item.

## Exiting from the Function setting mode

Press and hold [Q/⏪].

## 9-6. PTY (Program Type)

You can search for a station by selecting a Program Type.

### 1 Press [Control] knob.

Enters the Function setting mode.

### 2 Select "Settings" > "PTY Search" using [Control] knob.

For how to use [Control] knob, refer to <3-3. [How to select the item](#)> (page 13).

### 3 Select a Program Type using [Control] knob.

Program Type	Display
Speech	"Speech"
Music	"Music"
News	"News"
Current Affairs	"Affairs"
Information	"Info"
Sport	"Sport"
Education	"Educate"
Drama	"Drama"
Culture	"Arts"
Science	"Science"
Varied	"Talk"
Pop Music	"Pop"
Rock Music	"Rock"
Easy Listening Music	"Easy"
Light Classical	"Light M"
Serious Classical	"Classics"
Other Music	"Other M"
Weather	"Weather"
Finance	"Finance"
Children's programs	"Children"
Social Affairs	"Factual"
Religion	"Religion"
Phone In	"Phone In"
Travel	"Travel"
Leisure	"Leisure"
Jazz Music	"Jazz"
Country Music	"Country"
National Music	"Nation M"
Oldies Music	"Oldies"
Folk Music	"Folk"
Documentary	"Document"

Speech and music include the following types of programs.

Speech: Program type indicated by colored letters

Music: Program type indicated by black letters

### 4 Press [◀◀] or [▶▶] to select a station.

#### Exiting from the PTY mode.

Press [Q/↵].

#### "NO PTY" display

- When the selected Program Type is not found, "No PTY" appears. Select another Program Type.

#### Case where this function cannot be used

- This function cannot be used during reception of a traffic bulletin or AM broadcast.

# 10. Listen to the Digital Radio (KDC-BT73DAB)

## 10-1. Listening to the Digital Radio

### Selecting a tuner source

Press [SRC] to select a Digital Radio ("DIGITAL RADIO") source.

Refer to <Source selection> (page 14).

### Searching an ensemble

Press and hold [◀◀] or [▶▶].

### Searching an ensemble, service, and component

Press [◀◀] or [▶▶].

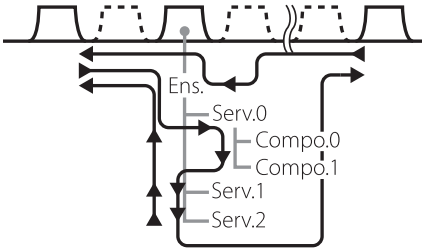

◀◀: Press [◀◀]

▶▶: Press [▶▶]

Ens.: ensemble

Serv.: service

Compo.: component

The seek mode can be changed. Refer to <Selecting a Seek mode> (refer to below), <10-9. Digital Radio setting> (page 50).

### Selecting a Seek mode

Press [▼].

Display	Operation
"Auto1"	Press: Select an ensemble, service, and component. Press and hold: Automatic search for an ensemble.
"Auto2"	Search in order of the service in the preset memory.
"Manual"	Press: Select an ensemble, service, and component. Press and hold: Manually search for an ensemble.

### Updating Service List information

Press and hold [▲].

## 10-2. Service preset memory

You can store an ensemble, service, and component in the memory.

**1 Press [◀◀] or [▶▶] to select the ensemble, service, and component.**

**2 Press [Q/↵] twice.**

Enter the Preset memory mode.

**3 Turn [Control] knob to select a memory number ("1" – "18").**

**4 Press and hold [Control] knob.**

### Exiting from the Preset memory mode

Press and hold [Q/↵].

### About the Mix Station preset mode

- If you press [Q/↵] three times in step 2, the Mix Station preset mode is selected with "Mixed Preset List" displayed. In this mode, different bands and tuner sources (FM, AM, Digital Radio etc.) can be saved in the same preset layer, which allows you to recall a desired station without switching between bands and/or tuner sources. Maximum of 6 stations can be preset in the Mix Station preset mode. Once the Mix Station preset mode is set, you can enter the same mode by just pressing [Q/↵] once in step 2. Pressing [Q/↵] twice allows you to return to the normal Station preset mode.

### 10-3. Recall preset service

---

Recall the service in the memory.

**1 Press [Q/➤] twice.**

Enter the Preset memory mode.

**2 Turn [Control] knob to select a memory number ("1" – "18").**

**3 Press [Control] knob.**

### 10-4. Service list select

---

You can select the component you would like to listen to from the service list.

**1 Press [Q/➤].**

The service list is displayed in the alphabetical order.

**2 Turn [Control] knob to select a service, and then press [Control] knob.**

# Listen to the Digital Radio (KDC-BT73DAB)

## 10-5. Alphabet Search for service

You can select an alphabetic character from the service list.

**1 Press [Q/↵].**

**2 Press and hold [Control] knob.**

Enter the Alphabet Search mode

**3 Select a character using [Control] knob.**

**Exiting from the Alphabet search mode**

Press and hold [Q/↵].

**Notes on Alphabet search**

- To search for a character other than A to Z and 1, enter ""\*"

## 10-6. PTY (Program Type)

You can search for a station by selecting a Program Type.

**1 Press [Control] knob.**

Enters the Function setting mode.

**2 Select "Settings" > "PTY Search" using [Control] knob.**

For how to use [Control] knob, refer to <3-3. How to select the item> (page 13).

**3 Select a Program Type using [Control] knob.**

Program Type	Display
Speech	"Speech"
Music	"Music"
News	"News"
Current Affairs	"Affairs"
Information	"Info"
Sport	"Sport"
Education	"Educate"
Drama	"Drama"
Culture	"Arts"
Science	"Science"
Varied	"Talk"
Pop Music	"Pop"
Rock Music	"Rock"
Easy Listening Music	"Easy"
Light Classical	"Light M"
Serious Classical	"Classics"
Other Music	"Other M"
Weather	"Weather"
Finance	"Finance"
Children's programs	"Children"
Social Affairs	"Factual"
Religion	"Religion"
Phone In	"Phone In"
Travel	"Travel"
Leisure	"Leisure"
Jazz Music	"Jazz"
Country Music	"Country"
National Music	"Nation M"
Oldies Music	"Oldies"
Folk Music	"Folk"
Documentary	"Document"

Speech and music include the following types of programs.

Speech: Program type indicated by colored letters

Music: Program type indicated by black letters

**4 Press [◀◀] or [▶▶] to select a station.**

**Exiting from the PTY mode.**

Press [Q/↵].



### "NO PTY" display

- When the selected Program Type is not found, "No PTY" appears. Select another Program Type.

### Case where this function cannot be used

- This function cannot be used during reception of a traffic bulletin or AM broadcast.

## 10-7. Announcement setup

When a service set to ON begins, it will switch from receiving any source to receiving announcement.

### 1 Press [Control] knob.

Enters the Function setting mode.

### 2 Select "Settings" > "ASW Select" using [Control] knob.

For how to use [Control] knob, refer to <3-3. How to select the item> (page 13).

### 3 Turn [Control] knob to select an announcement.

Program Type	Display
Time table of public transportation	"Travel"
Information with lower importance than Alarm	"Warning"
News	"News"
Weather news	"Weather"
Event information	"Event"
Unscheduled event information	"Special"
Radio program announcement	"Rad info"
Sports news	"Sports"
Financial and economic news	"Finance"

### 4 Press [Control] knob.

Pressing the button each time switches the setting between On and Off.

"\*" indicator lights up when an announcement program type is set to ON.

### Exiting from the Function setting mode

Press and hold [Q/↵].

# Listen to the Digital Radio (KDC-BT73DAB)

## 10-8. Replay

You can replay last about 7 minutes (audio bit rate: 128 kbps) of current service.

### 1 Press [▲]

"Replay Mode" appears and enters the Replay mode.

During Replay, you can perform the following operations:

Operation type	Operation
Pause and play	Press and hold [Q/↵].
Forward or backward 15 seconds	Press [◀◀] or [▶▶].
Fast forward or Fast backward	Press and hold [◀◀] or [▶▶].

### Exiting from the Replay mode.

#### Press [▲]

The on-air song is received.

## 10-9. Digital Radio setting

You can set the Digital Radio related items.

### 1 Press [Control] knob.

Enters the Function setting mode.

### 2 Select "Settings" using [Control] knob.

### 3 Select a Digital Radio setting item using [Control] knob.

Display	Description
"Seek Mode"	Sets the Digital Radio seek mode. Refer to <10-1. Listening to the Digital Radio> (page 46)
"DAB Priority"	When this setting item is set to ON, the station will automatically switch to a Radio Data System Broadcast with the same radio program in event the reception for Digital Radio becomes poor. In the same manner, the station will automatically switch to a Digital Radio Broadcast with the same radio program in event the reception for Radio Data System becomes poor. (If the same program is not being broadcasted on either, it will not switch between Digital Radio and Radio Data System). <b>"ON" / "OFF"</b>
"DAB List Update"	Sets updating method for "DAB List Update" Service list information. <b>"ON"</b> : Automatically updates the service list when ACC is turned ON. <b>"OFF"</b> : Updates the service list only when [▲] is pressed and held.
"PTY Watch"	When a broadcast with program type set to "PTY Watch" starts with the ensemble currently being received, the reception for broadcast automatically switches to that program type. Refer to <10-6. PTY (Program Type)> (page 48) <b>"Watch OFF" / program type (29 types)</b>
"TI"	Switches to the traffic information automatically when the traffic bulletin starts. <b>"ON" / "OFF"</b>
"DAB Blend"	Prevents audio break when switching from Digital Radio to Analog Radio. <b>"ON" / "OFF"</b>

(Colored text: Factory setting)

### 4 Select a setting using [Control] knob.

Returns to the previous item.

### Exiting from the Function setting mode

Press and hold [Q/↵].

## 10-10. Digital Radio initial settings

You can configure initial settings of Digital Radio.

### 1 Press [SRC] to select a Standby ("STANDBY").

Refer to <Source selection> (page 14).

### 2 Press [Control] knob.

Enters the Function setting mode.

### 3 Select "Initial Settings" using [Control] knob.

For how to use [Control] knob, refer to <3-3. How to select the item> (page 13).

### 4 Select a Digital Radio initial setting item using [Control] knob.

Display	Description
"DAB L-Band"	Allows switching to L band when set to "ON". "ON" / "OFF"
"DAB Antenna Power"	Sets power supply to the Digital Radio antenna. Set to "ON" when the Digital Radio antenna in use is equipped with a booster. "ON" / "OFF"

(Colored text: Factory setting)

### 5 Select a setting using [Control] knob.

Returns to the previous item.

### Exiting from the Function setting mode

Press and hold [Q/↩].

# 11. Display settings

## 11-1. Selecting a display type

Shown below are examples of display types.

### 1 Press [Control] knob.

Enters the Function setting mode.

### 2 Select "DISP&ILLUMI" > "Display Select" > "Type Select" using [Control] knob.

For how to use [Control] knob, refer to <3-3. How to select the item> (page 13).

### 3 Select a Display type using [Control] knob.

Display type	Display information
Type A	Displays 3 lines of text.
Type B	Displays 2 line of text.
Type C	Displays the clock.
Type D	Displays the Spectrum analysis [1]/Motion graphics [2].
Type E [3]	Displays the Dynamic Label of Digital Radio.
Type F	Turn off the display and key illumination. (5 seconds after completion of operation)

[1] Function of KDC-BT73DAB/ KDC-BT53U.

[2] Function of KDC-5057SD.

[3] Function of KDC-BT73DAB. Selectable only when in the Digital Radio source.

### Exiting from the Function setting mode

Press and hold [Q/↵].

## 11-2. Information display setting

You can set the side and graphic parts of the display.

### 1 Press [Control] knob.

Enters the Function setting mode.

### 2 Select "DISP&ILLUMI" > "Display Select" using [Control] knob.

For how to use [Control] knob, refer to <3-3. How to select the item> (page 13).

### 3 Select a display setting item using [Control] knob.

Display	Description
"Side Select"	Sets the side part display for Type A, B, and D. 1 / 2 / 3 (Type A, B only)
"Graphic Select" [1]	Sets the Type D Spectrum analysis display. 1 / 2
"Status"	Sets the status display (ON/OFF indicator for each function) for Type A and B. [2] "ON" / "OFF"

(Colored text: Factory setting)

[1] Function of KDC-BT73DAB/ KDC-BT53U.

[2] The status display automatically turns "OFF" during aha source and cannot be switched to ON.

### 4 Select a setting using [Control] knob.

Returns to the previous item.

### Exiting from the Function setting mode

Press and hold [Q/↵].

### 11-3. Illumination color selection

You can select the illumination color of the panel.

#### 1 Press [Control] knob.

Enters the Function setting mode.

#### 2 Select "DISP&ILLUMI" > "Color Select" using [Control] knob.

For how to use [Control] knob, refer to <3-3. How to select the item> (page 13).

#### 3 Select a illumination part using [Control] knob.

Display	Part
"Color SEL All"	All
"Color SEL Display"	Display
"Color SEL Key"	Button

#### 4 Select a color ("Variable Scan"/ "Color1" — "Color24"/ "User") using [Control] knob.

#### **Exiting from the Function setting mode**

Press and hold [Q/↵].

### 11-4. Adjusting the Illumination color

You can adjust the illumination color of the panel.

#### 1 Select the illumination color you want to adjust.

Select from among "Color1" to "Color24" or "User" with reference to <11-3. Illumination color selection> (page 53).

#### 2 Press and hold [Control] knob.

The RGB value of the selected illumination color is displayed and enters the Details color adjustment mode.

#### 3 Set the color.

Operation type	Operation
To select the color to adjust (Red, Green, or Blue)	Press [I◀◀] or [▶▶I].
To adjust color (Range: 0 – 9)	Turn [Control] knob.
Determination of the adjusted color.	Press [Control] knob.

The color you created can be called by selecting "User".

#### **Exiting from the Function setting mode**

Press and hold [Q/↵].

# Display settings

## 11-5. Selecting a text display

You can change the information displayed on each of the following sources:

### 1 Press [Control] knob.

Enters the Function setting mode.

### 2 Select "DISP&ILLUMI" > "Display Select" > "Text Select" using [Control] knob.

For how to use [Control] knob, refer to <3-3. How to select the item> (page 13).

### 3 Press [▲] or [▼] to select a text display part.

The selected text display part blinks.

### 4 Select a text display using [Control] knob.

#### On Audio file/ iPod source

Information	Display
Song title*	"Song Title"
Album name*	"Album Name"
Artist name*	"Artist Name"
Title and Artist name**	"Title/Artist"
Album and Artist name**	"Album/Artist"
Folder name	"Folder Name"
File name	"File Name"
Play time	"P-Time"
Spectrum analysis and Clock[1]	"Speana/Clock"
Clock[2]	"Clock"
Date	"Date"
Blank	"Blank"

#### On CD source

Information	Display
Disc title	"Disc Title"
Track title	"Track Title"
Play time	"P-Time"
Spectrum analysis and Clock[1]	"Speana/Clock"
Clock[2]	"Clock"
Date	"Date"
Blank	"Blank"

#### KDC-BT73DAB On Digital Radio source

Information	Display
Service label	"Service Label"
PTY label	"PTY Label"
Ensemble label	"Ensemble Label"
Artist name*	"Artist Name"
Song title*	"Song Title"
Album name*	"Album Name"
Genre	"Genre"
Channel number	"Channel Number"
Name information of next program	"Next Program"
Audio Bitrate	"BIT Rate"
Antenna reception sensitivity	"Signal Level"
Spectrum analysis and Clock	"Speana/Clock"
Date	"Date"
Blank	"Blank"

#### On Tuner source

Information	Display
Station name (FM)[3]	"Station Name"
Radio text + (FM)[3]	"Radio Text +"
Radio text (FM)[3]	"Radio Text"
Spectrum analysis and Clock[1]	"Speana/Clock"
Clock[2]	"Clock"
Date	"Date"
Blank	"Blank"
Frequency	"Frequency"
Song title (FM)*[3]	"Song Title"
Artist name (FM)*[3]	"Artist Name"
Title & Artist name (FM)**[3]	"Title/Artist"

#### KDC-BT73DAB KDC-BT53U On Bluetooth audio source

Information	Display
Play time	"P-Time"
Song title*	"Song Title"
Album name*	"Album Name"
Artist name*	"Artist Name"
Song title and Artist name**	"Title/Artist"
Album name and Artist name**	"Album/Artist"
Spectrum analysis and Clock	"Speana/Clock"
Date	"Date"
Blank	"Blank"

#### On Standby/ Auxiliary input source

Information	Display
Source name (AUX only)	"Source Name"
Spectrum analysis and Clock (AUX only)[1]	"Speana/Clock"
Clock	"Clock"
Date	"Date"
Blank	"Blank"

[1] Function of KDC-BT73DAB/ KDC-BT53U.

[2] Function of KDC-5057SD.

[3] Function of KDC-BT73DAB.

\*Display type A only

\*\*Display type B only

## **Exiting from the Function setting mode**

**Press and hold [Q/↵].**

### **Notes on text display**

- If the selected display item does not have any information, alternative information is displayed.
- Setting is available when the display type is A or B which allows text display. Refer to <11-1. [Selecting a display type](#)> (page 52).
- Some items cannot be selected depending on the display type and row.
- If you select "Folder name" while playing music on the iPod, names will be displayed depending on the currently selected browsing items.
- If you select the APP & iPod Control mode while playing music on the iPod, "APP & iPod Mode" appears.
- If all characters cannot be displayed while music is played on the iPod, the file number in the list is displayed.

<b>Information</b>	<b>Display</b>
Music title	"TITLE****"
Folder name	"FLD****"
File name	"FILE****"

- Text display cannot be switched during aha source.

# Display settings

## 11-6. Display & Illumination setting

You can set the display and illumination.



### 1 Press [Control] knob.

Enters the Function setting mode.

### 2 Select "DISP&ILLUMI" using [Control] knob.

For how to use [Control] knob, refer to <3-3. How to select the item> (page 13).

### 3 Select a Display & Illumination setting item using [Control] knob.

Display	Description
"Display Dimmer"	Dims the display part in conjunction with the Light switch of the vehicle. <b>"Auto"</b> : Dims the display in conjunction with the Light switch of the vehicle. <b>"Manual1"</b> : Dims the display constantly. <b>"Manual2"</b> : Dims the display darker than that in the Manual1 mode. <b>"OFF"</b> : Does not dim the display.
"Contrast"	Sets the display contrast. <b>"1"</b> – <b>"10"</b> – <b>"30"</b>
"DISP NEGA/POSI"	Switches the panel display between positive and negative modes. <b>"NEGA1"</b> : Displays the text in the negative mode. <b>"NEGA2"</b> : When the interior light is off, the text is displayed in the negative mode; when the interior light is on, the text is displayed in the positive mode. <b>"POSI1"</b> : Displays the text in the positive mode. <b>"POSI2"</b> : When the interior light is off, the text is displayed in the positive mode; when the interior light is on, the text is displayed in the negative mode.
"Text Scroll"	Sets the method of scrolling to view hidden texts. <b>"Auto"</b> : Scrolls. <b>"Once"</b> : Scrolls once. <b>"OFF"</b> : Does not scroll.
"BT DVC Status" <sup>[1]</sup>	You can display the connection status, signal strength, and battery level.  : Battery level of cell phone.  : Signal strength of cell phone.
"ILLUMI Dimmer"	Reduces the key Illumination brightness. <b>"Auto"</b> : Dims the illumination in conjunction with the Light switch of the vehicle. <b>"Manual1"</b> : Dims the illumination constantly. <b>"Manual2"</b> : Dims the illumination darker than that in the Manual1 mode. <b>"OFF"</b> : Does not dim the illumination.
"ILLUMI Effect"	Sets whether the key illumination is changed in conjunction with the key operation. <b>"ON"</b> / <b>"OFF"</b>

"ILLUMI MSC SYNC" <sup>[1]</sup>	Sets whether the key illumination color is changed in conjunction with the sound volume. <b>"ON"</b> / <b>"OFF"</b>
----------------------------------	--

(Colored text: Factory setting)

[1] Function of KDC-BT73DAB/ KDC-BT53U.

### 4 Select a setting using [Control] knob.

Returns to the previous item.

### Exiting from the Function setting mode

Press and hold [Q/↵].





## 12. General settings

### 12-1. Adjusting the clock

---

**1 Press [Control] knob.**

Enters the Function setting mode.

**2 Select “Settings” > “Clock&Date” > “Clock Adjust” using [Control] knob.**

For how to use [Control] knob, refer to [<3-3. How to select the item> \(page 13\)](#).

**3 Set the hour using [Control] knob.**

**4 Set the minute using [Control] knob.**

**Exiting from the Function setting mode**

Press and hold [Q/↵].

**Notes**

- When Radio Data System station time data is received with “ON” selected for “Time Synchronized” ([<12-3. Clock & date display type setting> \(page 59\)](#)), the clock is adjusted automatically.

### 12-2. Adjusting the date

---

**1 Press [Control] knob.**

Enters the Function setting mode.

**2 Select “Settings” > “Clock&Date” > “Date Adjust” using [Control] knob.**

For how to use [Control] knob, refer to [<3-3. How to select the item> \(page 13\)](#).

**3 Set the year using [Control] knob.**

**4 Set the month using [Control] knob.**

**5 Set the day using [Control] knob.**

**Exiting from the Function setting mode**

Press and hold [Q/↵].

## 12-3. Clock & date display type setting

You can set the display type of the clock and calendar.

### 1 Press [Control] knob.

Enters the Function setting mode.

### 2 Select "Settings" > "Clock&Date" using [Control] knob.

For how to use [Control] knob, refer to <3-3. How to select the item> (page 13).

### 3 Select a Clock & Date setting item using [Control] knob.

Display	Description
"Time Synchronized"	Synchronizes this unit's clock with the radio data system station's time data. "ON" / "OFF"
"Date Mode"	Sets the date display mode. 7 types

(Colored text: Factory setting)

### 4 Select a setting using [Control] knob.

Returns to the previous item.

### Exiting from the Function setting mode

Press and hold [Q/↵].

## 12-4. Auxiliary input display setting

You can set the display when switched the AUX source.

### 1 Press [SRC] to select an Auxiliary Input ("AUX") source.

Refer to <12-7. Initial settings> (page 61).

### 2 Press [Control] knob.

Enters the Function setting mode.

### 3 Select "Settings" > "AUX Name Set" using [Control] knob.

For how to use [Control] knob, refer to <3-3. How to select the item> (page 13).

### 4 Select a display ("AUX", "DVD", "PORTABLE", "GAME", "VIDEO", or "TV") using [Control] knob.

### Exiting from the Function setting mode

Press and hold [Q/↵].

## General settings

### 12-5. Muting the audio upon reception of a phone call

---

*Function of KDC-5057SD*

The audio system automatically mutes when it receives an incoming call.

#### **When a call comes in**

"CALL" appears.

The audio system pauses.

#### **Listening to the audio during a call**

Press [SRC].

The "CALL" display disappears and the audio system comes back ON.

#### **When the call ends**

Hang up the phone.

The "CALL" display disappears and the audio system comes back ON.

#### **To use this function**

- To use the TEL Mute feature, you need to hook up the MUTE wire to your telephone using a commercial telephone accessory. Refer to <[Connecting wires to terminals](#)> in Quick start guide.

### 12-6. Demonstration mode setting

---

You can turn on/off the demonstration mode.

#### **1 Press [Control] knob.**

Enters the Function setting mode.

#### **2 Select "DEMO Mode" using [Control] knob.**

For how to use [Control] knob, refer to <[3-3. How to select the item](#)> (page 13).

#### **3 Select a setting ("ON" or "OFF") using [Control] knob.**

Returns to the previous item.

#### **Exiting from the Function setting mode**

Press and hold [Q/⏪].

## 12-7. Initial settings

You can configure initial settings of this unit.

### 1 Press [SRC] to select a Standby (“STANDBY”).

Refer to <Source selection> (page 14).

### 2 Press [Control] knob.

Enters the Function setting mode.

### 3 Select “Initial Settings” using [Control] knob.

For how to use [Control] knob, refer to <3-3. How to select the item> (page 13).

### 4 Select an Initial setting item using [Control] knob.

Display	Description
“SRC Select”	Set source selection method. “1”: The source switches each time [SRC] is pressed. “2”: Press [SRC], Turn [Control] knob to select the source, and then press [Control] knob to determine it.
“Key Beep”	Setting the operation check sound (beep sound) ON/OFF. “ON” / “OFF”
“Russian”	When this is set to ON, the following character strings are displayed in Russian: Folder name/ File name/ Song title/ Artist name/ Album name “ON” / “OFF”
“Function Language”	Changes the display language of items displayed in the Function setting mode. “English” / “Français” / “Español” / “Deutsch” / “Italiano” / “Русский”
“Power OFF Wait”	Setting the timer to turn this unit’s power OFF automatically when Standby mode continues. Using this setting can save the vehicle’s battery power. “OFF”: Power OFF Timer function is OFF. “20MIN”: Turns the power OFF after 20 minutes. “40MIN”: Turns the power OFF after 40 minutes. “60MIN”: Turns the power OFF after 60 minutes.
“aha Source” [2]	Sets whether to display aha during source selection. “ON” / “OFF”
“Built-in AUX”	Sets whether to display AUX during source selection. “ON” / “OFF”

“CD Read”	Sets the method for reading CD. When unable to play a special format CD, set this setting to “2” to force playing. Note that some music CDs may be unplayable even when set to “2”. In addition, audio files cannot be played when set to “2”. Normally, keep this set to “1”. 1: Automatically distinguishes between the audio file disc and music CD when playing a disc. 2: Forces playing as a music CD.
“Built-in AMP”	Selecting “OFF” turns off the built-in amplifier. Turning off the built-in amplifier improves the quality of the sound from Preout. “ON” / “OFF”
“Speaker Select” [1]	Sets the speaker type so that the System Q value is optimal. “OFF”: OFF “5/4inch”: For 5 & 4 in. speaker “6x9/6inch”: For 6 & 6x9 in. speaker “O.E.M.”: For the OEM speaker
“F/W Update”	Upgrades the firmware. Selecting “YES” and then pressing [Control] knob starts upgrading the firmware. For how to update the firmware, access our web site. <a href="http://www.kenwood.com/cs/ce/">http://www.kenwood.com/cs/ce/</a>

(Colored text: Factory setting)

[1] Function of KDC-5057SD.

[2] Function of KDC-BT73DAB/ KDC-BT53U.

### 5 Select a setting using [Control] knob.

Returns to the previous item.

### Exiting from the Function setting mode

Press and hold [Q/⏪].

## 13. Registering a Bluetooth (KDC-BT73DAB, KDC-BT53U)

### 13-1. About the Bluetooth module

This unit conforms to the following Bluetooth specifications:

#### Version

- Bluetooth Ver. 2.1+EDR Certified

#### Profile

- HFP (Hands Free Profile)
- SPP (Serial Port Profile)
- PBAP (Phonebook Access Profile)
- OPP (Object Push Profile)
- A2DP (Advanced Audio Distribution Profile)
- AVRCP (Audio/Video Remote Control Profile)

For the cell phones verified for compatibility, access the following URL:

<http://www.kenwood.com/cs/ce/bt/>

#### Notes

- The units supporting the Bluetooth function have been certified for conformity with the Bluetooth Standard following the procedure prescribed by Bluetooth SIG. However, it may be impossible for such units to communicate with your cell phone depending on its type.
- HFP is a profile used to make a hands-free call.
- OPP is a profile used to transfer data such as a phone book between units.

### 13-2. Registering a Bluetooth device

You can register your Bluetooth device in this unit.

#### 1 Start registering a unit by operating the Bluetooth device.

Operate the Bluetooth device to request this unit for connection.

The name of this unit ("KDC-####") is displayed on the Bluetooth device.

"Pairing Press the volume knob" appears.

#### 2 Press [Control] knob.

Pairing starts. When pairing is completed, "Pairing Success" appears.

Some Bluetooth device requests you to enter a PIN code. The PIN code is set to "0000" as default.

#### Bluetooth module that can be used with this unit

- For details on the Bluetooth cell phone with the hands-free function, see <13-1. About the Bluetooth module> (page 62).

#### Registration of iPod touch or iPhone

- This unit is compatible with an Apple Auto Pairing function. Connecting the iPod touch or iPhone to this unit with a Dock Connector to USB cable will automatically register it as a Bluetooth device. If you do not register it, select "OFF" for "Auto Pairing" according to <16-6. Bluetooth detail setting> (page 77).

#### When registration is impossible

- If there are 5 Bluetooth devices registered, you cannot register a new Bluetooth device.
- When any error code is displayed while the pairing is in progress, refer to <17-3. Error messages> (page 79).

#### When SMS is received

- When the connected Bluetooth device receives SMS, "SMS Received" appears on this unit.

### 13-3. Selecting the Bluetooth device you wish to connect

---

When two or more Bluetooth devices have already been registered, you need to select the Bluetooth device you wish to use.

**1 Press [↵].**

"BT MODE" appears and enter the Bluetooth mode.

**2 Select "Settings" > "Pairing" > "Phone Selection" (to select the cell phone) or "Audio Selection" (to select the audio player) using [Control] knob.**

For how to use [Control] knob, refer to <3-3. How to select the item> (page 13).

"(name)" appears.

**3 Select a Bluetooth device using [Control] knob.**

\*'(name)' or '-(name)' is displayed.

"\*": The selected Bluetooth device is busy.

"-": The selected Bluetooth device is on standby.

" " (blank): The Bluetooth device is deselected.

**Exiting from the Bluetooth mode**

Press [↵].

**When no device can be selected**

- If a cell phone is already selected, deselect it, and then select a different one.
- If you cannot select a device using the audio player, connect the device with the audio player.

### 13-4. Deleting a registered Bluetooth device

---

You can delete a registered Bluetooth device.

**1 Press [↵].**

"BT MODE" appears and enter the Bluetooth mode.

**2 Select "Settings" > "Pairing" > "Device Delete" using [Control] knob.**

For how to use [Control] knob, refer to <3-3. How to select the item> (page 13).

"(name)" appears.

**3 Select a Bluetooth device using [Control] knob.**

**4 Select "YES" using [Control] knob.**

"Completed" appears.

**Exiting from the Bluetooth mode**

Press [↵].

**When a registered device is deleted**

- When a registered cell phone is deleted, its phone Book and log are also deleted.

# Registering a Bluetooth (KDC-BT73DAB, KDC-BT53U)

## 13-5. Bluetooth device registration test

You can check whether a Bluetooth device can be registered by operating this unit.

### 1 Press [F].

"BT MODE" appears and enter the Bluetooth mode.

### 2 Select "BT Test Mode" using [Control] knob.

For how to use [Control] knob, refer to <3-3. [How to select the item](#)> (page 13).

### 3 Start registering a unit by operating the Bluetooth device.

"Please pairing your phone" appears.

Operate the Bluetooth device to request this unit for connection.

The name of this unit ("KDC-####") is displayed on the Bluetooth device.

Some Bluetooth device requests you to enter a PIN code. The PIN code is set to "0000" as default.

### 4 Press [Control] knob.

When pairing is completed successfully, a connection test starts automatically.

When the connection test is completed, test results are displayed on a function basis ("OK": Enabled; "NG": Disabled).

Display	Description
"Pairing"	Registration in this unit
"HF Connect"	Hands-free phoning
"AUD Connect"	Audio playback
"PB Download"	Phone Book downloading

### 5 Press [Control] knob.

Exits the test mode.





## 14. Hands-free phoning (KDC-BT73DAB, KDC-BT53U)

### 14-1. Receiving a call

---

#### *You can answer a phone call*

Press [↵].

Either of the following operations will disconnect the line.

- Inserting a CD.
- Connecting a USB device.

#### *Rejecting an incoming call*

Press [SRC].

### 14-2. Calling a number in the phone book

---

#### **1 Press [↵].**

"BT MODE" appears and enter the Bluetooth mode.

#### **2 Select "Phone Book" using [Control] knob.**

For how to use [Control] knob, refer to <3-3. [How to select the item](#)> (page 13).

#### **3 Select a name using [Control] knob.**

#### **4 Select a phone number using [Control] knob.**

#### **5 Press [↵].**

Makes a call.

#### **When there is no phone book**

- If the phone book has not yet been downloaded automatically, download it according to <16-2. [Downloading the phone book](#)> (page 74).

#### **Display of phone book**

- During search, a non-accent character such as "u" is searched for instead of an accent character such as "ü".

## 14-3. Dialing a number

### 1 Press [📞].

"BT MODE" appears and enter the Bluetooth mode.

### 2 Select "Number Dial" using [Control] knob.

For how to use [Control] knob, refer to <3-3. [How to select the item](#)> (page 13).

### 3 Enter a phone number.

Operation type	Operation
Selection of number	Turn [Control] knob.
Selection of digit	Press [◀◀] or [▶▶].

### 4 Press [📞].

Makes a call.

#### Number of digits that can be input

- You can input a maximum of 32 digits.

## 14-4. Calling a number in the call log

### 1 Press [📞].

"BT MODE" appears and enter the Bluetooth mode.

### 2 Select "Call History" using [Control] knob.

For how to use [Control] knob, refer to <3-3. [How to select the item](#)> (page 13).

### 3 Turn [Control] knob to select a name and phone number.

▲ : Incoming calls

◀ : Outgoing calls

✓ : Missed calls

Pressing [Control] knob toggles between the name list and detailed display.

### 4 Press [📞].

Makes a call.

# Hands-free phoning (KDC-BT73DAB, KDC-BT53U)

## 14-5. Speed dialing (Preset dial)

---

**1 Press [↵].**

"BT MODE" appears and enter the Bluetooth mode.

**2 Select "Preset Call" using [Control] knob.**

For how to use [Control] knob, refer to [<3-3. How to select the item> \(page 13\)](#).

**3 Turn [Control] knob to select a recall number ("P1" – "P6").**

**4 Press [↵].**

Makes a call.

**Registration of dial number**

- You need to register the preset dial number. Refer to [<14-6. Registering in the preset dial number list> \(page 68\)](#).

## 14-6. Registering in the preset dial number list

---

**1 Press [↵].**

"BT MODE" appears and enter the Bluetooth mode.

**2 Enter the phone number you wish to register**

Enter the phone number with reference to the following:

[<14-3. Dialing a number> \(page 67\)](#)

[<14-4. Calling a number in the call log> \(page 67\)](#)

[<14-2. Calling a number in the phone book> \(page 66\)](#)

**3 Press and hold [Control] knob.**

**4 Turn [Control] knob to select a memory number ("P1" – "P6").**

**5 Press and hold [Control] knob.**

***Exiting from the Bluetooth mode***

Press [↵].

## 14-7. During a call

---

### **Disconnecting a call**

Press [⏏].

### **Switching to the Private mode**

Press [◀◀] or [▶▶].

Pressing this knob each time switches between the private talk mode ("PRIVATE") and hands-free talk mode.

### **When the previous source is restored in the Private mode**

- Depending on the type of your cell phone, switching to the private talk mode may select the source that was used before commencing the hands-free connection. If this happens, the source cannot be switched back to the hands-free talk mode by operating this unit. Operate your cell phone to return to the hands-free talk mode.

### **Adjusting the voice volume during a call**

Turn [Control] knob.

## 14-8. Clearing the disconnection message

---

### **1 Press [⏏].**

"HF Disconnect" disappears.

# Hands-free phoning (KDC-BT73DAB, KDC-BT53U)

## 14-9. Voice Control

This unit can access the voice recognition function of the connected cell phone. You can search the phone book by voice. (The function depends on the cell phone.)

### 1 Press and hold .





"Voice Control" appears and enter the Voice control mode.

### 2 Start speaking.

Speak a voice tag, etc. registered in the cell phone.

## 14-10. Display of phone number types (categories)

The category items in the phone book are displayed as follows:

Display	Information
"General" / 	General
"Home" / 	Home
"Office" / 	Office
"Mobile" / 	Mobile
"Other" / 	Other



## 15. Bluetooth audio (KDC-BT73DAB, KDC-BT53U )

### 15-1. Before use

---

- You need to register your Bluetooth audio player before using it with this unit. For more details, see <13-2. Registering a Bluetooth device> (page 62).
- You need to select the Bluetooth audio player you wish to connect. Refer to <13-3. Selecting the Bluetooth device you wish to connect> (page 63).

### 15-2. Basic operations

---

#### **Selecting a Bluetooth audio source**

Press [SRC] to select a Bluetooth audio ("BT AUDIO") source.

Refer to <Source selection> (page 14).

#### **Pause and play a song**

Press and hold [Q/↵].

#### **Selecting a song**

Press [◀◀] or [▶▶] button.

#### **Fast-forwarding or fast-backwarding a song**

Press and hold [◀◀] or [▶▶].

#### **Selecting an audio file folder**

Press [▲] or [▼] button.

#### **Preparation for using the Bluetooth audio player**

- All or some of the operations above cannot be performed if the Bluetooth audio player is not ready for remote control.
- Switching between Bluetooth audio sources does not start or stop playback automatically. Perform the operation for starting or stopping playback.
- Some audio players cannot be controlled remotely or reconnected after Bluetooth disconnection. Operate the main unit of the audio player to connect a Bluetooth device.



## 15-3. Playback mode

---

You can select a playback mode, such as Random play and Repeat play.

### 1 Press [SRC] to select a Bluetooth audio ("BT AUDIO") source.

Refer to <Source selection> (page 14).

### 2 Press [Control] knob.

Enters the Function setting mode.

### 3 Select "Play Mode" using [Control] knob.

For how to use [Control] knob, refer to <3-3. How to select the item> (page 13).

### 4 Select a playback mode function using [Control] knob.

Display	Description
"Random"	When set to "ON", plays the songs randomly. <input checked="" type="checkbox"/> (ON) / <input type="checkbox"/> (OFF)
"All Random"	When set to "ON", plays the all songs randomly. <input checked="" type="checkbox"/> (ON) / <input type="checkbox"/> (OFF)
"File Repeat"	When set to "ON", plays the select songs repeatedly. <input checked="" type="checkbox"/> (ON) / <input type="checkbox"/> (OFF)
"All Repeat"	When set to "ON", plays the all songs repeatedly. <input checked="" type="checkbox"/> (ON) / <input type="checkbox"/> (OFF)

### 5 Press [Control] knob.

The setting is changed.

### **Exiting from the Function setting mode**

Press and hold [Q/↶].

#### Available functions

- The available playback functions differ depending on the type of the connected Bluetooth audio player.

## 16. Bluetooth settings (KDC-BT73DAB, KDC-BT53U)

### 16-1. Registering the PIN code

By operating the Bluetooth device, specify the PIN code necessary for registering this unit.

#### 1 Press [F].

"BT MODE" appears and enter the Bluetooth mode.

#### 2 Select "Settings" > "Detailed Settings" > "PIN Code Edit" using [Control] knob.

For how to use [Control] knob, refer to <3-3. How to select the item> (page 13).

#### 3 Input the PIN code

Operation type	Operation
Selection of numbers	Turn [Control] knob.
Movement to the next digit	Press [▶▶].
Deletion of the last digit	Press [◀◀].
Transmission of PIN code	Press [Control] knob.

If "Completed" appears and registration is complete.

#### Exiting from the Bluetooth mode

Press [F].

#### Notes on PIN code input

- By default, "0000" is specified.
- A PIN code can be specified with up to eight digits.

### 16-2. Downloading the phone book

If the phone book is not downloaded automatically to this unit to which a cell phone – which is not compatible with PBAP – is connected, download it in the following manner:

#### 1 Press [F].

"BT MODE" appears and enter the Bluetooth mode.

#### 2 Select "Settings" > "Transfer Phonebook" using [Control] knob.

For how to use [Control] knob, refer to <3-3. How to select the item> (page 13).

When downloading starts, "Downloading ###" appears.

When downloading is completed, "Completed" appears.

#### Exiting from the Bluetooth mode

Press [F].

#### Maximum number of phone numbers that can be registered

- Of all registered mobile phones, a total of 400 phones number can be registered.
- Up to 32 digits can be registered for each phone number along with up to 32\* characters representing a name. (\*32: Number of alphabetical characters. Fewer characters can be input depending on the type of characters.)

#### Cancellation of downloading

- To cancel downloading of the phone book data, operate the cell phone.

## 16-3. Deleting the phone book

You can delete the phone book stored in this unit to which a cell phone – which is not compatible with PBAP – is connected.

**1 Press [↵].**

"BT MODE" appears and enter the Bluetooth mode.

**2 Select "Phone Book" using [Control] knob.**

For how to use [Control] knob, refer to <3-3. [How to select the item> \(page 13\).](#)

**3 Select the name to be deleted using [Control] knob.**

**4 Press and hold [Control] knob.**

**5 Select the item to be deleted using [Control] knob.**

Display	Item to be deleted
"Delete Name"	All phone numbers registered for the selected name are deleted.
"Delete Number"	One of the phone numbers registered for the selected name is deleted.
"Delete All"	All phone numbers registered in the phone book are deleted.

When you selected "Delete Number", next select the number you want to delete using [Control] knob.

**6 Select "YES" using [Control] knob.**

"Completed" appears.

**Exiting from the Bluetooth mode**

Press [↵].

## Bluetooth settings (KDC-BT73DAB, KDC-BT53U)

### 16-4. Displaying the firmware version

You can view the version of the firmware of this unit.

**1 Press [F].**

"BT MODE" appears and enter the Bluetooth mode.

**2 Select "Settings" > "Detailed Settings" > "BT F/W Update" using [Control] knob.**

For how to use [Control] knob, refer to <3-3. [How to select the item> \(page 13\)](#).

The firmware version appears.

#### **Exiting from the Bluetooth mode**

Press [F].

#### **How to update**

- For how to update the firmware, access our web site.  
[www.kenwood.com/bt/information/](http://www.kenwood.com/bt/information/)

### 16-5. Switching between two connected cell-phones

When two Bluetooth devices are connected, you can assign the Bluetooth device to be used in priority to the other Bluetooth device.

**1 Press [F].**

"BT MODE" appears and enter the Bluetooth mode.

**2 Select "Device Priority" using [Control] knob.**

For how to use [Control] knob, refer to <3-3. [How to select the item> \(page 13\)](#).

**3 Select a "Sub -###-" using [Control] knob.**

"Main": Device used normally.

"Sub": Device used only for call reception.

**4 Press [Control] knob.**

#### **Exiting from the Bluetooth mode**

Press [F].

## 16-6. Bluetooth detail setting

You can configure the initial settings of this unit.

### 1 Press [🔊].

"BT MODE" appears and enter the Bluetooth mode.

### 2 Select "Settings" > "Detailed Settings" using [Control] knob.

For how to use [Control] knob, refer to <3-3. [How to select the item](#)> (page 13).

### 3 Select a Bluetooth detail setting item using [Control] knob.

Display	Description
"Auto Answer"	Automatically answers a call after lapse of the preset time interval. "OFF": Does not answer the phone call automatically. "1SEC" – "8SEC" – "99SEC": Automatically answers the phone call after lapse of 1 – 99 seconds.
"Auto Reconnect"	When set to "ON", starts re-pairing with the registered Bluetooth device automatically when it becomes unpaired. "ON" / "OFF"
"Auto Pairing"	When set to "ON", the Apple Auto Pairing function is turned on to automatically register the iPod touch or iPhone connected to this unit. "ON" / "OFF"
"Bluetooth HF/Audio"	Specifies the output speakers for hands-free voice communication and Bluetooth audio sound. "Front": Outputs sound from the front speakers. "All": Outputs sound from the front and rear speakers.
"Call Beep"	Sets whether to output a beep from the speaker when a call comes in. "ON": Outputs a beep. "OFF": Does not output a beep.
"MIC Gain"	Adjusts the sensitivity of the microphone for telephone call or adjusts the voice of the caller. "-20" – "0" – "+8"
"Echo Cancel Level"	Sets the echo cancellation level. "1" – "4" – "10"

(Colored text: Factory setting)

### 4 Select a setting using [Control] knob.

Returns to the previous item.

### Exiting from the Bluetooth mode

Press [🔊].

## 17. Troubleshooting guide

### 17-1. Setting error

Some functions of this unit may be disabled by some settings made on this unit.

- **Cannot set up display.**
  - The demonstration mode is not turned off as mentioned in [<12-6. Demonstration mode setting>](#) (page 60).
- **Cannot set the "Text Select", "Side Select", or "Status" setting for the "Display Select" item.**
  - A display type is not selected as mentioned in [<11-1. Selecting a display type>](#) (page 52).
- **Cannot set up the equalizer.**
- **Cannot set up the Bass Boost.**
- **Cannot set up the Sound Enhancements.**
- **Cannot set up the Position control.**
- **Cannot set up the Loudness.**
  - The DSP function is disabled.
    - ☛ "DSP Set" of [<5-1. Audio control>](#) (page 18)

### 17-2. Operation/wiring error

What might seem to be a malfunction in your unit may just be the result of a slight operation error or a wiring error. Before calling for service, first check the following table for possible problems.

#### General

- **The key beep does not sound**
  - The Preout jack is in use.
    - ☛ The key beep cannot be output from the Preout jack.
- **Sound cannot be heard.**
- **The unit does not turn on.**
- **Information shown on the display is incorrect.**
  - The connectors are dirty.
    - ☛ Clean the connectors. Refer to [<Cleaning the connector>](#) (page 4).

#### Tuner source

- **Radio reception is poor.**
  - The car antenna is not extended.
    - ☛ Pull the antenna out all the way.

#### Disc source

- **The specified disc does not play, but another one plays instead.**
  - The specified CD is quite dirty.
    - ☛ Clean the CD with reference to [<8-11. Handling discs>](#) (page 41).
  - The disc is severely scratched.
    - ☛ Try another disc instead.

#### Audio file source

- **The sound skips when an Audio file is being played.**
  - The media is scratched or dirty.
    - ☛ Clean the CD with reference to [<8-11. Handling discs>](#) (page 41).
  - The recording condition is bad.
    - ☛ Play the media again or use another media.

## 17-3. Error messages

---

The messages shown below indicates your system condition.

- **"TOC Error"**
  - ❑ The CD is quite dirty. The CD is upside-down. The CD is scratched a lot.
  - ❑ The disc is unreadable.
- **"IN" (blink)**
  - ❑ The CD player section is not operating properly.
    - Reinsert the CD. If the CD cannot be ejected or the display continues to blink even when the CD has been properly reinserted, please switch off the power and consult your nearest service center.
- **"Protect" (blink)**
  - ❑ The speaker wire has short-circuited or touched the chassis of the vehicle, and then the protection function has been activated.
    - Lay or insulate the speaker cable properly and press the Reset button. If "Protect" does not disappear, consult your nearest service center.
- **"NA File"**
  - ❑ An Audio file is played in a format that is not supported by this unit.
- **"Copy PRO"**
  - ❑ A copy-protected file is played.
- **"Read Error"**
  - ❑ The file system of the connected USB device is broken.
    - Copy the files and folders for the USB device again. If "Read Error" is still displayed, initialize the USB device or use another USB device.
- **"No Device"**
  - ❑ A USB device is selected as a source although no USB device is connected.
    - Change the source to any source other than the USB device. Connect a USB device, and change the source to the USB device again.
- **"N/A Device"**
  - ❑ An unsupported USB device is connected.
  - ❑ Connection to the iPod has failed.
    - Check that the connected iPod is supported. See <8-6. About the Audio file> (page 39) for information on supported iPods.
- **"No Music Data"**
  - ❑ The connected USB device contains no playable audio file.
  - ❑ A medium that does not have playable data has been played.
- **"Please Eject"**
  - ❑ The unit is malfunctioning for some reason.
    - Press and hold [▲].
    - Press the reset button on the unit. If the "Please Eject" code does not disappear, consult your nearest service center.
- **"iPod Error"**
  - ❑ Connection to the iPod has failed.
    - Remove the iPod and then reconnect it.
    - Reset iPod/ iPhone.
- **"No Number"**
  - ❑ The calling party does not notify a caller ID.
  - ❑ There is no phone number data.
- **"No Data"**
  - ❑ There is no outgoing call list.
  - ❑ There is no incoming call list.
  - ❑ There is no missed call list.
  - ❑ There is no phone book list.
- **"No Entry"**
  - ❑ The cell phone has not been registered (pairing).
- **"HF Disconnect"**
  - ❑ The unit cannot communicate with the cell phone.
- **"AUD Disconnect"**
  - ❑ The unit cannot communicate with the Bluetooth audio player.
- **"HF Error 68"**
  - ❑ The unit cannot communicate with the cell phone.
    - Cycle the power switch. If this message still appears, press the Reset button on the control unit.
- **"HF Error 89"**
  - ❑ Update of the firmware has failed.
    - Retry update of the firmware.
- **"Device Full"**
  - ❑ 5 Bluetooth device have already been registered. No more Bluetooth devices are registered.
- **"Pairing Failed"**
  - ❑ Pairing error.
- **"N/A Voice Tag"**
  - ❑ No voice tags are registered in your cell phone.
- **"No Phonebook"**
  - ❑ Data is not contained in the phone book.
- **"No Support"**
  - ❑ The connected Bluetooth device does not support a voice recognition function.
- **"No Active Device"**
  - ❑ Any Bluetooth device supporting a voice recognition function is not connected.
- **"Antenna Error"**
  - ❑ The antenna has a short-circuit and the protective circuit has activated.
    - Check the Digital Radio antenna. If a passive antenna without a booster is used, set "DAB Antenna Power" to "OFF". Refer to <10-10. Digital Radio initial settings> (page 51)

# Troubleshooting guide

## aha Messages

- **"Disconnect"**
  - ❑ Check the connection to the device.
- **"Check Device"**
  - ❑ Set aha application active.
- **"Loading"**
  - ❑ Log in to aha.
- **"Login Failed"**
  - ❑ Logging in to aha has failed.
- **"Aha App Update Required"**
  - ❑ Upgrade the aha application to the latest version.
- **"Aha Unavailable"**
  - ❑ Maintenance of Aha Radio Server is in progress.
- **"Network Unavailable"**
  - ❑ Connection to Aha Radio Server is impossible.
- **"Poor GPS"**
  - ❑ GPS reception is impossible.
- **"Connect Phone"**
  - ❑ Connect the cell phone.
- **"Action NA"**
  - ❑ The pressed key is invalid.
- **"Select Station"**
  - ❑ Select a station.





---

**KENWOOD**