

KENWOOD

DDX4025DAB
DDX4025BT
DDX4055BT

DDX3025
DDX3055
DDX355

MONITOR WITH DVD RECEIVER
INSTRUCTION MANUAL

JVCKENWOOD Corporation



CONTENTS

| | | | |
|--|-----------|---|-----------|
| BEFORE USE | 2 | BLUETOOTH (Only for DDX4025DAB/ DDX4025BT/DDX4055BT) | 28 |
| How to reset your unit..... | 3 | SETTINGS | 36 |
| INITIAL SETTINGS | 4 | Sound adjustment | 36 |
| BASICS | 6 | Adjustment for video playback..... | 37 |
| Component names and functions | 6 | Changing display design..... | 39 |
| Common operations..... | 7 | Customizing the <Top Menu> screen..... | 40 |
| Common screen operations..... | 8 | Customizing the system settings | 40 |
| Selecting the playback source..... | 9 | Setting menu items..... | 42 |
| DISCS | 10 | REMOTE CONTROLLER | 45 |
| USB | 14 | CONNECTION/INSTALLATION | 49 |
| iPod/iPhone | 15 | REFERENCES | 54 |
| TUNER | 19 | Maintenance..... | 54 |
| DIGITAL RADIO (DAB) (Only for DDX4025DAB) | 22 | More information..... | 54 |
| OTHER EXTERNAL COMPONENTS | 26 | Error message list..... | 58 |
| Using external audio/video players—AV-IN | 26 | Troubleshooting..... | 59 |
| Using a rear view camera | 26 | Specifications..... | 61 |
| Using the external navigation unit | 27 | | |

BEFORE USE

⚠ **WARNINGS: (To prevent accidents and damage)**

- DO NOT install any unit or wire any cable in a location where;
 - it may obstruct the steering wheel and gearshift lever operations.
 - it may obstruct the operation of safety devices such as air bags.
 - it may obstruct visibility.
- DO NOT operate the unit while driving. If you need to operate the unit while driving, be sure to look around carefully.
- The driver must not watch the monitor while driving.

The marking of products using lasers



The label is attached to the chassis/case and says that the component uses laser beams that have been classified as Class 1. It means that the unit is utilizing laser beams that are of a weaker class. There is no danger of hazardous radiation outside the unit.

How to read this manual:

- Illustrations of DDX4025BT are mainly used for explanation. The displays and panels shown in this manual are examples used to provide clear explanations of the operations. For this reason, they may be different from the actual displays or panels.
- This manual mainly explains operations using the buttons on the monitor panel and touch panel. For operations using the remote controller (KNA-RCDV331: separately purchased), see page 45.
- < > indicates the various screens/menus/operations/settings that appear on the touch panel.
- [] indicates the buttons on the touch panel.
- **Indication language:** English indications are used for the purpose of explanation. You can select the indication language from the <Setup> menu. (Page 44)

BEFORE USE



Information on Disposal of Old Electrical and Electronic Equipment and Batteries (applicable for EU countries that have adopted separate waste collection systems)

Products and batteries with the symbol (crossed-out wheeled bin) cannot be disposed as household waste.

Old electrical and electronic equipment and batteries should be recycled at a facility capable of handling these items and their waste byproducts. Contact your local authority for details in locating a recycle facility nearest to you.

Proper recycling and waste disposal will help conserve resources whilst preventing detrimental effects on our health and the environment. Notice: The sign "Pb" below the symbol for batteries indicates that this battery contains lead.

For Israel

מידע בדבר השלכה לאשפה של ציוד חשמלי ואלקטרוני ישן וכן סוללות (רלוונטי למדינות שמשמשות במערכת איסוף אשפה מופרדת).

לא ניתן להשליך מוצרים וסוללות עם הסימון (פח אשפה עם X עליו) כאשפה ביתית רגילה. יש למחזר ציוד חשמלי ואלקטרוני ישן וכן סוללות במתקן המסוגל לטפל בפריטים כאלה ובתוצרי הלוואי שלהם.

צרו קשר עם הרשות המקומית לקבלת פרטים אודות מתקן המיחזור הקרוב אליכם. מיחזור והשלכה לאשפה נאותים יעזרו לשמר משאבים ולמנוע השפעות שליליות על בריאותנו ועל הסביבה.

שימו לב: הסימון Pb שמתחת לסימון עבור סוללות מצייין שהסוללה מכילה נופרת.

For DDX3025/DDX3055/DDX355



Declaration of Conformity with regard to the EMC Directive 2004/108/EC

Declaration of Conformity with regard to the RoHS Directive 2011/65/EU

Manufacturer:

JVC KENWOOD Corporation

3-12 Moriya-cho, Kanagawa-ku, Yokohamashi, Kanagawa, 221-0022, Japan

EU Representative:

JVCKENWOOD NEDERLAND B.V.

Amsterdamseweg 37, 1422 AC UITHOORN, The Netherlands

⚠ Cautions on the monitor:

- The monitor built into this unit has been produced with high precision, but it may have some ineffective dots. This is inevitable and is not considered defective.
- Do not expose the monitor to direct sunlight.
- Do not operate the touch panel using a ball-point pen or similar tool with a sharp tip. Touch the buttons on the touch panel with your finger directly (if you are wearing a glove, take it off).
- When the temperature is very cold or very hot...
 - Chemical changes occur inside, causing malfunction.
 - Pictures may not appear clearly or may move slowly. Pictures may not be synchronized with the sound or picture quality may decline in such environments.

For safety...

- Do not raise the volume level too much, as this will make driving dangerous by blocking outside sounds, and may cause hearing loss.
- Stop the car before performing any complicated operations.

Temperature inside the car...

If you have parked the car for a long time in hot or cold weather, wait until the temperature in the car becomes normal before operating the unit.

❑ How to reset your unit

DDX4025DAB/DDX4025BT/DDX4055BT/
DDX3025/DDX3055



DDX355



If the unit fails to operate properly, press the Reset button. The unit returns to factory settings when the Reset button is pressed (except the registered Bluetooth devices).

INITIAL SETTINGS

Initial setup

When you power on the unit for the first time or reset the unit, the initial setting screen appears.

- You can also change the settings on the **<Setup>** screen. (Page 42)

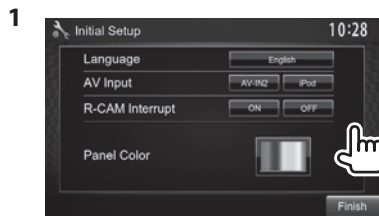

<Language> Select the text language used for on-screen information. (Page 44)

- Set **<GUI Language>** to display the operation buttons and menu items in the selected language (**[Local]**: initially selected) or English (**[English]**).

<AV Input> Select an external component connected to the iPod/AV-IN2 input terminal to play.

<R-CAM Interrupt> Select **[On]** when connecting the rear view camera. (Page 43)

<Panel Color> Select the color of the buttons on the monitor panel. (Page 43)

2 Finish the procedure.

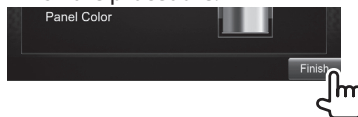

The **<Top Menu>** screen is displayed.

Setting the security function

You can set a security code to protect your receiver system against theft.

❑ Registering the security code

1 Display the **<Top Menu>** screen.

On the source control screen:



2 Display the **<System>** setting screen.

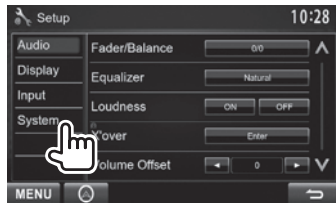

3 Display the **<Security Code Set>** screen.

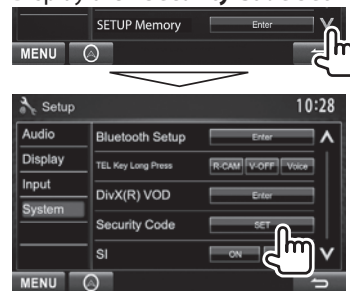

- To clear the registered security code, perform steps 1 and 2, then press **[CLR]** in **<Security Code>**.

4 Enter a four-digit number (①), then confirm the entry (②).



- Press **[Clear]** to delete the last entry.
- Press **[Cancel]** to cancel the setting.

5 Repeat step 3 to confirm your security code.

Now, your security code is registered.

- When the unit is being reset or disconnected from the battery, you are required to enter the security code. Enter the correct security code, then press **[Enter]**.

INITIAL SETTINGS

❑ Activating the security function

You can activate the security function to protect your receiver system against theft.

- 1 Display the **<System>** setting screen.
On the **<Top Menu>** screen:

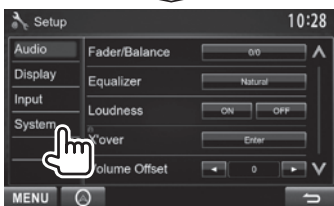

The security indicator on the monitor panel flashes when the vehicle ignition is off.

To deactivate the security function: Select **[OFF]** for **<SI>**.

Clock settings

- 1 Display the **<Top Menu>** screen.
On the source control screen:



- 2 Display the **<Setup>** screen.



- 3 Display the **<Clock>** screen.

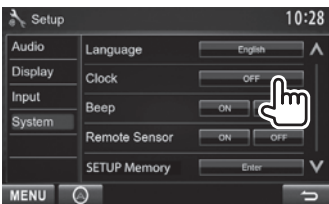
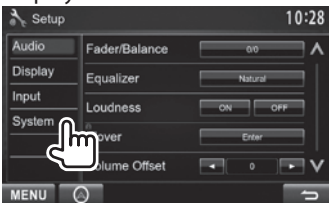

- 4 Set the clock time.

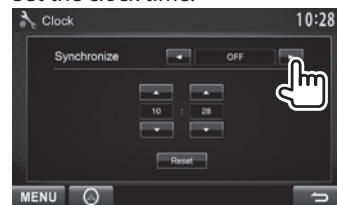

<NAV>*1 Synchronizes the clock time with the connected navigation unit.

<Radio Data System> Synchronizes the clock time with FM Radio Data System.

<DAB>*2 Synchronizes the clock time with the digital radio (DAB).

<OFF> Sets the clock manually. (See below.)

When selecting **<OFF>**:

Adjust the hour (①), then adjust the minute (②).

- Press **[Reset]** to set the minute to "00".



- 5 Finish the procedure.



*1 Appears only when the navigation unit is connected.

*2 Only for DDX4025DAB.

BASICS

Component names and functions

DDX4025DAB/DDX4025BT/DDX4055BT/ DDX3025/DDX3055

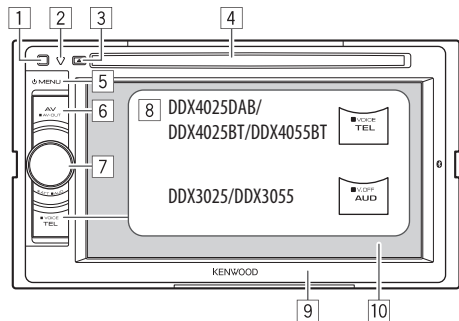

DDX355

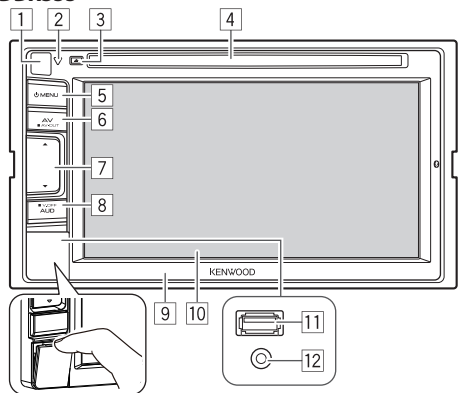

- 1 Remote sensor
- 2 Reset button/Power indicator/Security indicator
 - Resets the unit. (Page 3)
 - Lights up while the unit is turned on.
 - Flashes when the security function is activated. (Page 5)
- 3 ▲ (Eject) button
Ejects the disc.
- 4 Loading slot
- 5 ⏸ MENU button
 - Displays the <Top Menu> screen. (Press) (Page 8)
 - Turns off the power. (Hold) (Page 7)
 - Turns on the power. (Press) (Page 7)
- 6 AV/AV OUT button
 - Displays the current source screen. (Press)
 - Selects the AV source for external monitor or amplifier. (Hold)
- 7 For DDX4025DAB/DDX4025BT/DDX4055BT: Volume/ATT/AUD knob
 - Attenuates the sound. (Press) (Page 7)
 - Adjusts the audio volume. (Turn) (Page 7)
 - Displays the <Tone> screen. (Hold) (Page 36)

For DDX3025/DDX3055: Volume/ATT knob

 - Attenuates the sound. (Press) (Page 7)
 - Adjusts the audio volume. (Turn) (Page 7)

For DDX355: Volume ▲/▼ buttons

 - Adjusts the audio volume. (Press) (Page 7)

- 8 For DDX4025DAB/DDX4025BT/DDX4055BT: TEL/VOICE button
 - Displays the <Handsfree> screen. (Press) (Page 31)
 - The function of the button when held varies depending on the <TEL Key Long Press> setting. (Page 44)

For DDX3025/DDX3055/DDX355: AUD/V.OFF button

 - Displays the <Tone> screen. (Press) (Page 36)
 - The function of the button when held varies depending on the <AUD Key Long Press> setting. (Page 44)
- 9 Monitor panel*
- 10 Screen (touch panel)
- 11 For DDX355 only
USB input terminal
- 12 For DDX355 only
iPod/AV-IN2 input terminal

* You can change the color of the buttons on the monitor panel. (Page 39)

⚠ Caution on the volume setting:

Digital devices produce very little noise compared with other sources. Lower the volume before playing these digital sources to avoid damaging the speakers by sudden increase of the output level.

BASICS

Common operations

Turning on the power

DDX4025DAB/
DDX4025BT/DDX4055BT/
DDX3025/DDX3055



Turning off the power

DDX4025DAB/
DDX4025BT/DDX4055BT/
DDX3025/DDX3055

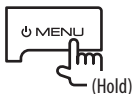

DDX355



DDX355

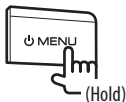

Adjusting the volume

To adjust the volume (00 to 35)

DDX4025DAB/DDX4025BT/
DDX4055BT/DDX3025/
DDX3055



Turn to the right to increase, and turn to the left to decrease.

DDX355

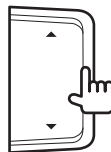

Press ▲ to increase, and press ▼ to decrease.

- Holding the button increases/decreases the volume continuously.

To attenuate the sound (only for DDX4025DAB/
DDX4025BT/DDX4055BT/DDX3025/DDX3055)



The ATT indicator lights up.

To cancel the attenuation: Press the same button again.

Putting the unit in standby

- 1 Display all <Top Menu> items.
On the <Top Menu> screen:



- 2

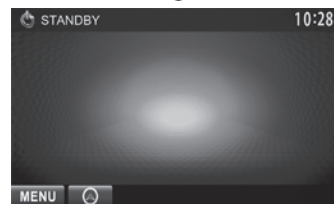

BASICS

Turning off the screen

DDX4025DAB/DDX4025BT/
DDX4055BT*1



DDX3025/DDX3055*2



DDX355*2



To turn on the screen: Press MENU on the monitor panel, or touch the display.

*1 This operation works only when **<TEL Key Long Press>** is set to **[V-OFF]**. (Page 44)

*2 This operation works only when **<AUD Key Long Press>** is set to **[V-OFF]**. (Page 44)

Common screen operations

Common screen descriptions

You can display other screens any time to change the source, show the information, or change the settings, etc.

Source control screen

Performs source playback operations.

- The operation buttons vary depending on the selected source.

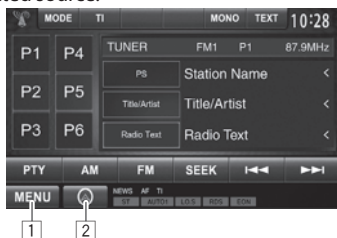

Common operation buttons:

- Displays the **<Top Menu>** screen. (See below.)
 - Pressing MENU on the monitor panel also displays the **<Top Menu>** screen.
- Displays the screen of the connected navigation unit.* (Page 27)

<Top Menu> screen

Displays the source control screen and settings screen.



Common operating buttons:

- Changes the playback source. (Page 9)
 - Press **[ALL SRC]** to display all **<Top Menu>** items. (Page 9)
 - You can arrange the items to display on the **<Top Menu>** screen (Page 40)
- Displays the **<Handsfree>** screen. (Page 31)
- Displays the **<Setup>** screen. (See below.)

<Setup> screen

Changes the detailed settings. (Page 42)

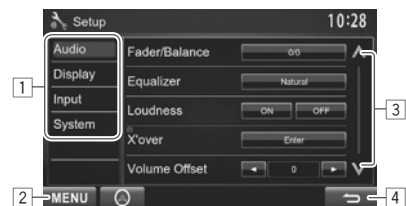

Common operating buttons:

- Selects the menu category.
- Displays the **<Top Menu>** screen.
- Changes the page.
- Returns to the previous screen.

* Appears only when a navigation unit is connected.

BASICS

Touch screen operations

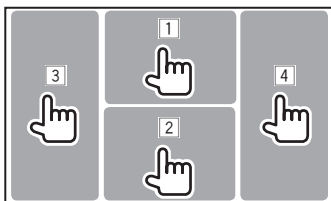

- 1 Displays the video control menu while playing a video.



- 2 Displays the source control screen while playing a video.



- The operation buttons disappear when the screen is touched or when no operation is done for about 5 seconds.

- 3 Goes to the previous chapter/track.*
4 Goes to the next chapter/track.*

* Not available for video from an external component.

Selecting the playback source



- You can change the items (other than **[SETUP]**) to display on the **<Top Menu>** screen. (Page 40)

- [NAV]***1 Displays the navigation screen when a navigation unit is connected. (Page 27)
- [DISC]** Plays a disc. (Page 10)
- [TUNER]** Switches to the conventional radio broadcast. (Page 19)
- [DAB]***2 Switches to the digital audio broadcast (DAB). (Page 22)
- [iPod]** Plays an iPod/iPhone. (Page 15)
- [USB]** Plays files on a USB device. (Page 14)
- [TEL]***3 Displays the **<Handsfree>** screen. (Page 31)
- [Bluetooth]***3 Plays a Bluetooth audio player. (Page 35)
- [AV-IN1][AV-IN2]***4 Switches to an external component connected to the AV-IN1 and iPod/AV-IN2 input terminal. (Page 26)

- *1 When no navigation unit is connected, "No Navigation" appears.
*2 Only for DDX4025DAB.
*3 Only for DDX4025DAB/DDX4025BT/DDX4055BT.
*4 Select an appropriate input setting in **<AV Input>**. (Page 43)

To display all sources and items on the <Top Menu> screen



DISCS

Playing a disc

- If a disc does not have a disc menu, all tracks on it will be played repeatedly until you change the source or eject the disc.
- For playable disc types/file types, see page 55.

Inserting a disc

Insert a disc with the label side facing up.
**DDX4025DAB/DDX4025BT/DDX4055BT/
DDX3025/DDX3055**

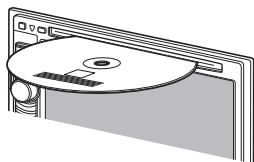

DDX355

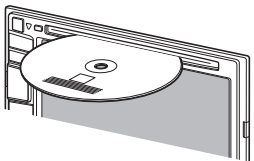

The source changes to **"DISC"** and playback starts.

- The IN indicator lights up while a disc is inserted.

- If "⊘" appears on the screen, the unit cannot accept the operation you have tried to do.
 - In some cases, without showing "⊘," operations will not be accepted.
- When playing back a multi-channel encoded disc, the multi-channel signals are downmixed to stereo.

Ejecting a disc



- When removing a disc, pull it horizontally.
- You can eject a disc when playing another AV source.
- If the ejected disc is not removed within 15 seconds, the disc is automatically inserted again into the loading slot to protect it from dust.

Playback operations

- When the operation buttons are not displayed on the screen, touch the area shown on the illustration.
 - To change settings for video playback, see page 37.

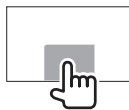

Indications and buttons on the source control screen

For DVD/VCD/DivX/MPEG1/MPEG2/JPEG



Playback information

- 1 Media type
- 2 Current playback item information
 - DVD Video: Title no./Chapter no.
 - DivX/MPEG1/MPEG2: Folder no./Track no.
 - JPEG: Folder no./File no.
 - VCD: Track no.
- 3 Playing time
- 4 Playback mode (Page 13)
- 5 File type (for DivX/MPEG1/MPEG2/JPEG)
- 6 IN indicator

DISCS

Operation buttons

[◀◀] [▶▶]

- Reverse/forward search during playback.*1
- Plays back in slow-motion during pause.
 - For DVD-VR/VCD: Reverse slow-motion playback is not available.

[■]*2

Stops playback.

[Q]*3

Displays the folder/track list. (See the far right column.)

[↻]

Selects playback mode.

[X]*4

(Page 13)

[▶▶]

Starts/pauses playback.

[|◀◀] [▶▶|]

- Selects a chapter/track. (Press)
- Reverse/forward search.*1 (Hold)

[📁] [📁]*3

Selects a folder.

[MODE]*5

Changes the settings for disc playback on the <DISC Mode> screen. (Page 13)

[MENU]

Displays the <Top Menu> screen.

*1 Search speed varies depending on the type of disc or file.

*2 Appears only for DVD/VCD.

*3 Does not appear for DVD/VCD.

*4 Does not appear for DVD/JPEG.

*5 Does not appear for VCD.

For CD/MP3/WMA/WAV/AAC

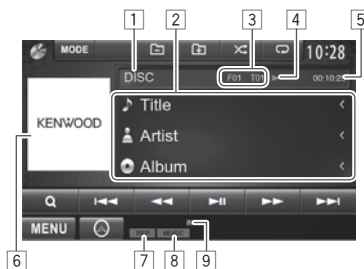

Playback information

- 1 Media type
- 2 Track/file information
 - Pressing [◀] scrolls the text if not all of the text is shown.
- 3 Current playback item information
 - MP3/WMA/WAV/AAC: Folder no./Track no.
 - CD: Track no.
- 4 Playback status (▶: play/||: pause)
- 5 Playing time
- 6 Jacket picture (Shown while playing if the file has tag data that includes the jacket picture)
- 7 Playback mode (Page 13)
- 8 File type
- 9 IN indicator

Operation buttons

[◀◀] [▶▶]

Reverse/forward search.*1

[Q]*2

Displays the folder/track list. (See the right column.)

[↻] [X]

Selects playback mode. (Page 13)

[▶▶]

Starts/pauses playback.

[|◀◀] [▶▶|]

Selects a track.

[📁] [📁]*2

Selects a folder.

[MODE]*2

Changes the settings for disc playback on the <DISC Mode> screen. (Page 13)

[MENU]

Displays the <Top Menu> screen.

*1 Search speed varies depending on the type of disc or file.

*2 Does not appear for CDs.

❑ Selecting a folder/track on the list

1



2

Select the folder (①), then the item in the selected folder (②).

- Repeat the procedure until you select the desired track.
- If you want to play all tracks in the folder, press [▶] on the right of the desired folder.

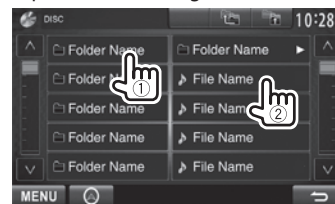

- You can change the page to display more items by pressing [▲]/[▼].
- Press [📁] to return to the root folder.
- Press [▶] to return to the upper layer.

DISCS

❑ Video menu operations

You can display the video menu screen during video playback.

- Available items on the screen differ depending on the types of the loaded disc and playback files.
- The operation buttons disappear when the screen is touched or when no operation is done for about 5 seconds.

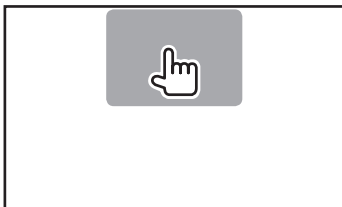

[ZOOM] Displays the picture size selecting screen. (Page 38)

[Aspect] Selects the aspect ratio. (Page 38)

[Picture Adjust] Displays the picture adjustment screen. (Page 37)

[Audio]* Selects the audio type.

[Subtitle]* Selects the subtitle type.

[Angle]* Selects the view angle.

[MENU]* Displays the disc menu (DVD).

[T MENU]* Displays the disc menu (DVD).

[CUR]* Displays the menu/scene selecting screen.

- **[▲]** **[▼]** **[◀]** **[▶]**: Selects an item.
 - For DivX: **[◀]** **[▶]** skips back or forward by about 5 minutes.
- **[Enter]**: Confirms the selection.
- **[Return]**: Returns to the previous screen.

[Highlight]* Switches to the direct disc menu mode. Touch the target item to select.

- To restore the screen, press AV on the monitor panel.

* Does not appear for MPEG1/MPEG2.

For VCD



[ZOOM] Displays the picture size selecting screen. (Page 38)

[Aspect] Selects the aspect ratio. (Page 38)

[Picture Adjust] Displays the picture adjustment screen. (Page 37)

[Audio] Selects the audio channel (ST: stereo, L: left, R: right).

[Return] Displays the previous screen or menu.

[MENU] Displays the disc menu.

[Direct] Displays/hides the direct selecting buttons. (See below.)

- To select a track directly, press **[Direct]** to display the direct selecting buttons, then...



– When you enter a wrong number, press **[Direct/CLR]** to delete the last entry.

- To deactivate the PBC function, stop playback, then use the direct selecting buttons to select a track number.

DISCS

❑ Selecting playback mode

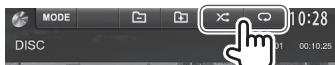

- [↺] Selects Repeat playback mode.
- [↻] Selects Random playback mode.

- For DVD: Repeat play is available.
For VCD (without PBC)/CD/DivX/MPEG1/MPEG2/MP3/WMA/WAV/AAC: Repeat and Random play are available.
 - You cannot activate the repeat mode and the random mode at the same time.
- Each time you press the button, the playback mode changes. (The corresponding indicator lights up.)
 - Available items differ depending on the types of loaded disc and playback file.

| | |
|---------------|---|
| C-REP | Repeats current chapter. |
| T-REP | Repeats current title/program. |
| REP | Repeats current track. |
| FO-REP | Repeats all tracks of the current folder. |
| FO-RDM | Randomly plays all tracks of the current folder, then tracks of the next folders. |
| RDM | Randomly plays all tracks. |

To cancel Repeat/Random playback: Press the button repeatedly until the indicator disappears.

Settings for disc playback



- The items shown on the <DISC Mode> screen are different depending on the discs/files played back.

❑ Setting items

| | |
|----------------------------------|---|
| <Menu Language> | Select the initial disc menu language. (Initial for DDX4025DAB/DDX4025BT/DDX3025: English , for DDX4055BT/DDX3055/DDX355: Russian) (Page 57) |
| <Audio Language> | Select the initial audio language. (Initial for DDX4025DAB/DDX4025BT/DDX3025: English , for DDX4055BT/DDX3055/DDX355: Russian) (Page 57) |
| <Subtitle Language> | Select the initial subtitle language or turn subtitles off (Off). (Initial for DDX4025DAB/DDX4025BT/DDX3025: English , for DDX4055BT/DDX3055/DDX355: Russian) (Page 57) |
| <Down Mix> | When playing back a multi-channel disc, this setting affects the signals reproduced through the front and/or rear speakers. <ul style="list-style-type: none"> • Dolby Surround: Select this to enjoy multi-channel surround sound by connecting an amplifier compatible with Dolby Surround. • Stereo (initial): Normally select this. |

<Dynamic Range Control>

You can change the dynamic range while playing Dolby Digital software.

- **Wide:** Select this to enjoy a powerful sound at a low volume level with its full dynamic range.
- **Normal:** Select this to reduce the dynamic range a little.
- **Dialog** (initial): Select this to reproduce movie dialog more clearly.

<Screen Ratio>

Select the monitor type to watch a wide screen picture on the external monitor.



<File Type>*

Select the playback file type when a disc contains different types of files.

- **Audio:** Plays back audio files.
- **Still Image:** Plays back JPEG files.
- **Video:** Plays back DivX/MPEG1/MPEG2 files.
- **Audio&Video** (initial): Plays back audio files and DivX/MPEG1/MPEG2 files.

* For playable file types, see page 55.
If the disc contains no files of the selected type, the existing files are played in the following priority: audio, video, then still picture.

USB

Connecting a USB device

You can connect a USB mass storage class device such as a USB memory, Digital Audio Player etc. to the unit.

- For details about connecting USB devices, see page 52.
- You cannot connect a computer or portable HDD to the USB input terminal.
- For playable file types and notes on using USB devices, see page 56.

When a USB device is connected...

The source changes to “**USB**” and playback starts.

- All tracks in the USB device will be played repeatedly until you change the source.

To disconnect the USB device safely:

Press [▲], then disconnect the USB device after “No Device” appears.

Playback operations

- When the operation buttons are not displayed on the screen, touch the area shown on the illustration.
 - To change settings for video playback, see page 37.

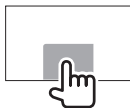

Indications and buttons on the source control screen

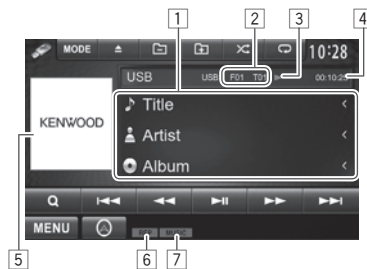

Playback information

- 1 Track/file information (for MP3/WMA/WAV/AAC)
 - Pressing [◀] scrolls the text if not all of the text is shown.
- 2 Current playback item information
 - DivX/MPEG1/MPEG2/MP3/WMA/WAV/AAC: Folder no./Track no.
 - JPEG: Folder no./File no.
- 3 Playback status (▶: play/||: pause)
- 4 Playing time
- 5 Jacket picture (Shown while playing if the file has tag data that includes the jacket picture)
- 6 Playback mode (See the right column.)
- 7 File type

Operation buttons

- [◀▶] Reverse/forward search.*1
- [Q] Displays the folder/track list. (Page 15)
- [↺] Selects repeat playback mode.*2 *3
 - **REP**: Repeats the current track.
 - **FO-REP**: Repeats all tracks in the current folder.
- [↻] Selects random playback mode.*2 *3
 - **FO-RDM**: Randomly plays all tracks in the folder.
 - **RDM**: Randomly plays all tracks.
- [▲] Disconnects the USB device safely.
- [▶||] Starts/pauses playback.
- [◀▶] Selects a track.
- [◀▶] Selects a folder.
- [MODE] Changes the settings on the <USB Mode> screen. (Page 15)
- [MENU] Displays the <Top Menu> screen.

*1 Search speed varies depending on the file type.

*2 To cancel random or repeat mode, press the button repeatedly until the indicator disappears.

*3 You cannot activate the repeat mode and the random mode at the same time.

USB

❑ <USB Mode> settings

Setting <File Type>

- [Audio]** Plays back audio files.
- [Still Image]** Plays back JPEG files.
- [Video]** Plays back DivX/MPEG1/MPEG2 files.
- [Audio&Video] (Initial)** Plays back audio files and DivX/MPEG1/MPEG2 files.

- For playable files, see page 56. If the USB device contains no files of the selected type, the existing files are played in the following priority: audio, video, then still picture.

Setting <Screen Ratio>

Select the monitor type to watch a wide screen picture on the external monitor.

[16:9] (Initial)

[4:3 LB]

[4:3 PS]



Setting <Drive Select>

Press [Next]. Switches between internal memory and the memory source of the connected device (such as mobile phone).

❑ Selecting a folder/track on the list

1



2 Select the folder (①), then the item in the selected folder (②).

- Repeat the procedure until you select the desired track.
- If you want to play all tracks in the folder, press [▶] on the right of the desired folder.



- You can change the page to display more items by pressing [▲]/[▼].
- Press [⏪] to return to the root folder.
- Press [⏩] to return to the upper layer.

iPod/iPhone

Preparation

❑ Connecting iPod/iPhone

- For details about connecting iPod/iPhone, see page 52.
- For playable iPod/iPhone types, see page 56.

Connect your iPod/iPhone using the appropriate cable according to your purpose.

- To listen to music:** USB Audio cable for iPod/iPhone—KCA-iP102 (optional accessory) or USB 2.0 cable (accessory of the iPod/iPhone)
- To watch video and listen to music:** USB Audio and Video cable for iPod/iPhone—KCA-iP22F/KCA-iP202 (optional accessory)
 - You cannot connect iPod nano (7th Generation)/iPod touch (5th Generation)/iPhone 5 with KCA-iP22F/KCA-iP202.

❑ Selecting preference settings for iPod/iPhone playback

When the source is "iPod"...

1



2

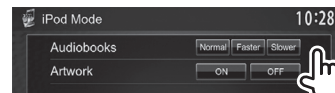

<Audiobooks> Select the speed of audio books.

<Artwork> Shows/hides the iPod artwork.

iPod/iPhone

❑ Setting <AV Input> for iPod/iPhone playback

Select an appropriate input setting for <AV Input> according to the connection method of the iPod/iPhone.

- You can change the setting only when [STANDBY] is selected on <Top Menu>. (page 7)

1 Display the <Input> setting screen.

On the <Top Menu> screen:

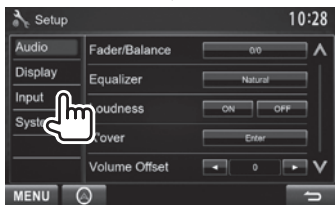

2

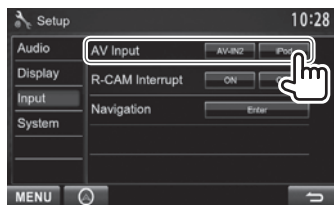

[AV-IN2] Select this when the iPod/iPhone is connected using KCA-iP102 (optional accessory) or the USB 2.0 cable (accessory of the iPod/iPhone).

[iPod] Select this when the iPod/iPhone is connected using KCA-iP22F/KCA-iP202 (optional accessory).

Playback operations

- When the operation buttons are not displayed on the screen, touch the area shown on the illustration.
 - To change settings for video playback, see page 37.

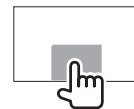

❑ Indications and buttons on the source control screen

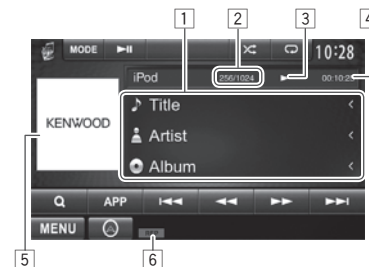

Playback information

- 1 Song/video information
 - Pressing [<] scrolls the text if not all of the text is shown.
- 2 Track no./Total track number
- 3 Playback status (▶: play/||: pause)
- 4 Playing time
- 5 Artwork (Shown if the song contains Artwork)
 - To change the Artwork display, see page 15.
- 6 Playback mode (Page 17)

iPod/iPhone

Operation buttons

[◀◀] [▶▶] Reverse/forward search.

[APP] Select to control playback from iPod/iPhone.*1

[Q] Displays the audio/video file list. (See the right column.)

[↻] Selects repeat playback mode.

- **REP:** Functions the same as "Repeat One."

- **ALL:** Functions the same as "Repeat All."

[⌘] Selects random playback mode.*2

- **RDM:** Functions the same as "Shuffle Songs."

- **A-RDM:** Functions the same as "Shuffle Albums."

[▶||] Starts/pauses playback.

[◀◀] [▶▶] Selects an audio/video file.*3

[MODE] Changes the settings for iPod/iPhone playback on the <iPod Mode> screen. (Page 15)

[MENU] Displays the <Top Menu> screen.

*1 When using iPod with video, you can control playback only from the unit.

*2 To cancel random mode, press the button repeatedly until the indicator disappears.

*3 Resume playback is unavailable for video files.

□ Selecting an audio/video file from the menu

1

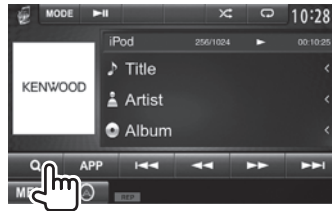

2

Select the menu (🎵: audio or 🎬: video) (①), a category (②), then a desired item (③).

- Select the item in the selected layer until a desired file starts playing.

- If you want to play all items in the layer, press [▶] on the right of the desired item.

Audio menu:

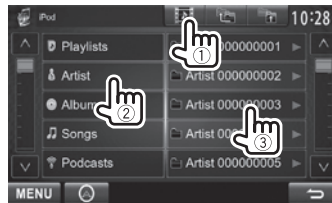

Video menu:

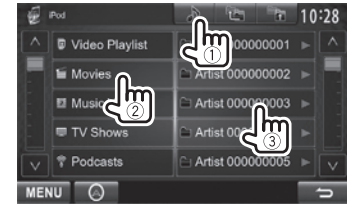

- You can change the page to display more items by pressing [▲]/[▼].

- Press [⏪] to return to the top layer.

- Press [⏩] to return to the upper layer.

- Available categories differ depending on the type of your iPod/iPhone.

iPod/iPhone

Controlling playback from the iPod/iPhone

You can play back the audio/video files or use App by operating iPod/iPhone itself instead of the unit.

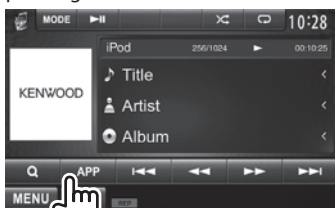

Garmin App:

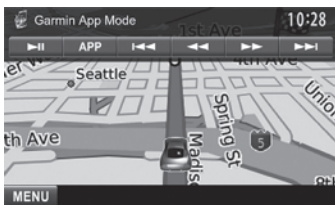

- The current position of your vehicle appears on the map. When the vehicle moves, the map scrolls.
- The screens of the iPhone and unit are not the same.
- To return to the normal mode, press **[APP]**.

- When you are using Garmin StreetPilot® Onboard, the screen appears. For Garmin StreetPilot® Onboard for iPhone, visit the Garmin web site: www.garmin.com

TUNER

Listening to the radio

Indications and buttons on the source control screen

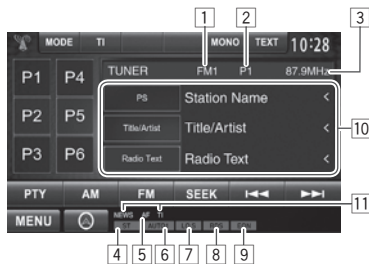

Tuner reception information

- 1 Band
- 2 Preset no.
- 3 The station frequency currently tuned in
- 4 ST/MONO indicator
 - The ST indicator lights up when receiving an FM stereo broadcast with sufficient signal strength.
- 5 AF indicator
- 6 Seek mode
- 7 LO.S indicator (See the far right column.)
- 8 RDS indicator: Lights up when receiving a Radio Data System station.
- 9 EON indicator: Lights up when a Radio Data System station is sending EON signals.
- 10 Text information
 - Pressing [**<**] scrolls the text if not all of the text is shown.
 - Pressing [**Radio Text**] switches the information between Radio Text, Radio Text Plus, and PTY code.
- 11 Standby reception indicators

Operation buttons

- [P1] – [P6]**
- Selects a stored station. (Press)
 - Stores the current station. (Hold)
- [MODE]** Changes the settings for tuner reception on the **<TUNER Mode>** screen. (See the right column.)
- [TI]** Activates/deactivates TI standby reception mode. (Page 20)
- [MONO]*** Activates/deactivates monaural mode for better FM reception. (Stereo effect will be lost.)
- The MONO indicator lights up while monaural mode is activated.
- [TEXT]** Changes the display information. (See the right column.)
- [PTY]*** Enters PTY search mode. (Page 20)
- [AM]** Selects the AM band.
- [FM]** Selects the FM band.
- ➔ FM1 ➔ FM2 ➔ FM3
- [SEEK]** Changes the seek mode.
- **AUTO1**: Auto Search
 - **AUTO2**: Tunes in the stations in memory one after another.
 - **MANU**: Manual Search
- [<<<] [>>>]** Searches for a station.
- The search method differs according to the selected seek mode. (See above.)
- [MENU]** Displays the **<Top Menu>** screen.

* Appears only when FM is selected as the source.

Changing the display information

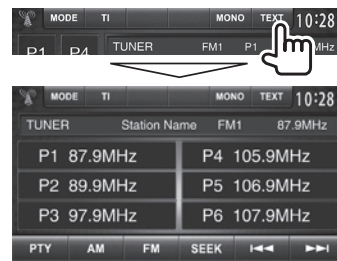

The preset list and the station name for FM Radio Data System (when PS signal is coming in) are displayed.

- Pressing [**TEXT**] again displays the text information for the station currently being received.

Tuning in FM stations only with strong signals—Local Seek

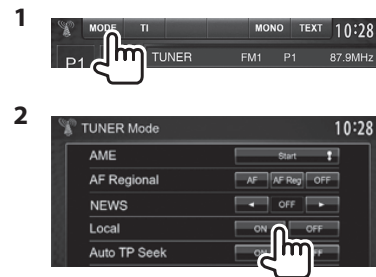

- [ON]** Select this to tune in only to stations with sufficient signal strength. The LO.S indicator lights up.
- [OFF]** Deactivate the function.

TUNER

Presetting stations

❑ Storing stations in the memory

You can preset 6 stations for each band.

Automatic presetting—AME (Auto Memory)



Local stations with the strongest signals are found and stored automatically.

Manual presetting

- 1 Tune in to a station you want to preset. (Page 19)
- 2 Select a preset number.



The station selected in step 1 is stored.

❑ Selecting a preset station



FM Radio Data System features

❑ Searching for FM Radio Data System programs—PTY Search

You can search for your favorite programs being broadcast by selecting the PTY code.

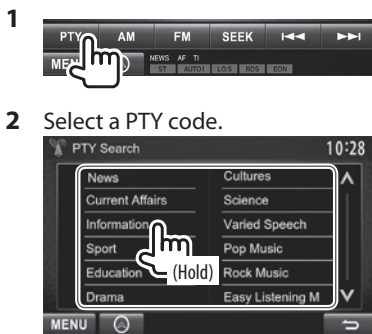

- 1
 - 2 Select a PTY code.
- You can change the page to display more items by pressing [A]/[V].

PTY Search starts.

If there is a station broadcasting a program of the same PTY code as you have selected, that station is tuned in.

- Only English/Spanish/French/German/Dutch/Portuguese are available for the text language here. If another language has been selected in <Language> (Page 44), the text language is set to English.

❑ Activating/deactivating TI/News Standby Reception

TI Standby Reception



The unit is in standby to switch to Traffic Information (TI) if available. (The TI indicator lights up in white.)

- If the TI indicator is lit in orange, tune into another station providing Radio Data System signals.

To deactivate TI Standby Reception: Press [TI]. (The TI indicator goes off.)

- The volume adjustment for Traffic Information is automatically memorized. The next time the unit switches to Traffic Information, the volume is set to the previous level.
- For DDX4025DAB: The TI Standby Reception can also be activated or deactivated from "DAB" source control screen. (Page 24)

TUNER

News Standby Reception

1



2



[00min] - Activate News Standby Reception
[90min] (the NEWS indicator lights up).
Select the period of time to disable interruption.

[OFF] Deactivate the function.

- The volume adjustment while receiving News is automatically memorized. The next time the unit switches to News, the volume is set to the previous level.

Tracing the same program—Network-Tracking Reception

When driving in an area where FM reception is not sufficient enough, this unit automatically tunes in to another FM Radio Data System station of the same network, possibly broadcasting the same program with stronger signals.

- When shipped from the factory, Network-Tracking Reception is activated.

To change the Network-Tracking Reception setting

1



2



[AF] Switch to another station. The program may differ from the one currently received (the AF indicator lights up).

[AF Reg] Switch to another station broadcasting the same program (the AF indicator lights up).

[OFF] Deactivate the function.

- The RDS indicator lights up when the Network-Tracking Reception is activated and an FM Radio Data System station is found.

Automatic TI station seek—Auto TP Seek

When traffic information station reception is poor, the unit automatically searches for another station that can be received better.

To activate Auto TP Seek

1



2



To deactivate Auto TP Seek: Press **[OFF]**.

DIGITAL RADIO (DAB) (Only for DDX4025DAB)

About DAB (Digital Audio Broadcasting)

What is DAB system?

DAB (Digital Audio Broadcasting) is one of the digital radio broadcasting systems available today. It can deliver digital quality sound without any annoying interference or signal distortion. Furthermore, it can carry text and data.

In contrast to FM broadcast, where each program is transmitted on its own frequency, DAB combines several programs (called "services") to form one "ensemble."

The "Primary component" (main radio station) is sometimes accompanied by a "secondary component" which can contain extra programs or other information.

Listening to Digital Radio

Indications and buttons on the source control screen

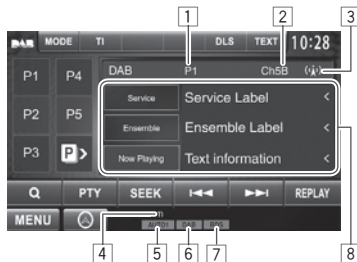

Tuner reception information

- 1 Preset no.
- 2 Channel no.
- 3 Signal strength
- 4 TI indicator
- 5 Seek mode
- 6 DAB reception indicator
 - The DAB indicator lights up when receiving an DAB broadcast.
 - The MC indicator lights up when receiving an DAB multi component.
- 7 RDS indicator: Lights up when receiving a Radio Data System station.
- 8 Text information
 - Pressing [**<**] scrolls the text if not all of the text is shown.
 - Pressing [**Now Playing**] switches the information. Each time you press the button, the information and the button switch between [**Audio Quality**], [**PTY**], [**Artists**], [**Title**], [**Now Playing**], and [**Next Program**].

Operation buttons

- [**P>**] Displays other preset numbers.
- [**P1**] – [**P15**] • Selects a stored service. (Press)
• Stores the current service. (Hold)
- [**MODE**] Changes the settings for DAB reception on the **<DAB Mode>** screen. (Page 25)
- [**TI**] Activates/deactivates TI standby reception mode. (Page 24)
- [**DLS**] Displays Dynamic Label Segment Screen (text messages the station sends)
- [**TEXT**] Changes the display information. (Page 23)
- [**Q**] Displays the **<List Type Select>** screen. (Page 23)
- [**PTY**] Enters PTY search mode. (Page 24)
- [**SEEK**] Changes the seek mode.
 - **AUTO1**: Auto Search
 - **AUTO2**: Tunes in the services in the memory one after another.
 - **MANU**: Manual SearchSearches for an ensemble, service, and component.
 - The search method differs according to the selected seek mode. (See above.)
- [**REPLAY**] Displays the **<Replay>** screen. (Page 24)
- [**MENU**] Displays the **<Top Menu>** screen.

DIGITAL RADIO (DAB)

❑ Changing the display information



The preset list of service labels is displayed.

- Pressing [TEXT] again displays the text information for the service or component currently being received.

❑ Selecting a service from the list

- 1 Display the <List Type Select> screen.



- 2 Select the list type.

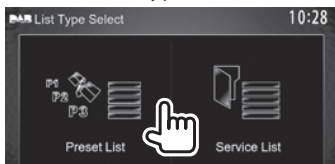

<Preset List> Selects from the preset list.

- To preset the services, see the far right column.

<Service List> Selects from the service names (Service List).

- 3 Select a service from the list.

On the <Preset List>

- You can change the page to display more items by pressing [▲]/[▼].

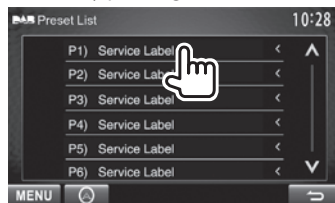

On the <Service List>

- You can change the page to display more items by pressing [▲]/[▼].

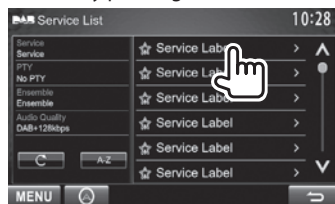

- Press [A-Z] to search for the initial letter. Pressing [A-Z] displays the <A-Z Search> screen. Select the initial to start the search.
 - If you want to search with non-alphabetical characters, press [Other].
- Press and hold [C] to update the <Service List>.

Presetting services

❑ Storing services in the memory

You can preset 15 services.

- 1 Select a service you want to preset. (Page 19)
- 2 Select a preset number.
 - If you want to select a preset number between P6 – P15, press [P>] to display those numbers.



The service selected in step 1 is stored.

DIGITAL RADIO (DAB)

Radio Data System features

❑ Searching for Radio Data System programs—PTY Search

You can search for your favorite programs being broadcast by selecting the PTY code.



2 Select a PTY code.

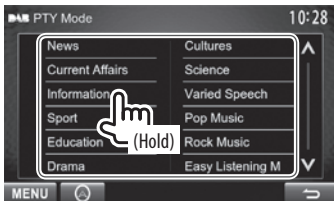

- You can change the page to display more items by pressing [▲]/[▼].

PTY Search starts.

If there is a service broadcasting a program of the same PTY code as you have selected, that service is tuned in.

- Only English/Spanish/French/German/Dutch/Portuguese are available for the text language here. If another language has been selected in <Language> (Page 44), the text language is set to English.

❑ Activating/deactivating TI Standby Reception



The unit is in standby to switch to Traffic Information (TI) if available. (The TI indicator lights up in white.)

- If the TI indicator is lit in orange, tune into another station providing Radio Data System signals.

To deactivate TI Standby Reception: Press [TI].
(The TI indicator goes off.)

- The volume adjustment for Traffic Information is automatically memorized. The next time the unit switches to Traffic Information, the volume is set to the previous level.
- For DDX4025DAB: The TI Standby Reception can also be activated or deactivated from “TUNER” source control screen. (Page 20)

Using the Replay function

You can temporarily record the broadcast from the current time, and replay the recorded data.

- You can not use the Replay function ([REPLAY] button is not available) in the following cases:
 - When the data is not recorded.
 - When receiving a service of the program type selected for <PTY WATCH>. (Page 25)
- When the recording capacity is full, the older recorded data is deleted and recording continues.
- If you change to another channel during playback, the recorded content will be lost.

❑ Entering the Replay mode



1 Progress bar

Shows the remaining capacity (gray) and the amount of recorded data (blue). If you have already recorded fully, the entire bar is indicated in blue.

- Updated every second.

2 Time code

Shows you the point of Replay you are listening to.

- Example: -5:00

- You are listening to data that is 5 minutes behind the current broadcast.

- Updated every second.

3 Playback status (▶: play / ||: pause / ◀◀: rewind / ▶▶: fast forward)

DIGITAL RADIO (DAB)

Operation buttons

- [◀◀][▶▶] Skips back or forward by about 15 seconds.
- [◀][▶] Rewind/Fast forward
- [▶▶] Starts/Pauses playback.

To exit the Replay mode (Returning to the channel reception screen)

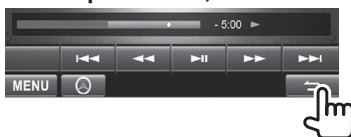

Settings for Digital Audio Radio

You can set the Digital Radio related items.



□ Setting items

<Priority>

- **ON** (initial): If the same service is provided by Digital Radio during Radio Data System reception, the unit automatically switches to Digital Radio. If the same service is provided by Radio Data System when reception of the service being provided by Digital Radio becomes poor, the unit automatically switches to Radio Data System.
- **OFF**: Deactivates.

<PTY WATCH>

If the service of the set program type begins with the ensemble being received, the unit switches from any source to Digital Radio for service reception. Select the type of program using [◀] and [▶].

<Announcement Select>

If the service of the announcement item you activated begins with the ensemble being received, this unit switches from any source to the announcement received.*

Set [ON] for the announcement items you need.

- **News flash/Transport flash/Warning/Service/ Area weather flash/ Event announcement/ Special event/Programme information/Spot report/ Financial report**
 - To deactivate all announcements, select **[ALL OFF]**.
 - Only English/Spanish/ French/German/Dutch/ Portuguese/Italian/ Turkish are available for the text language here. If another language has been selected in **<Language>** (Page 44), the text language is set to English.

<Seamless band>

- **ON** (initial): Prevents audio break when switching from Digital Radio to Analog Radio.
- **OFF**: Cancels.

* The volume adjustment while receiving Announcement is automatically memorized. The next time the unit switches to Announcement, the volume is set to the previous level.

OTHER EXTERNAL COMPONENTS

Using external audio/video players—AV-IN

When the operation buttons are not displayed on the screen, touch the area shown on the illustration.

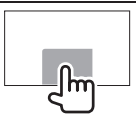

You can connect an external component to the AV-IN1 and iPod/AV-IN2 input terminals. (Page 52)

Preparation:

If you want to use “AV-IN2”, select [AV-IN2] for <AV Input> setting. (Page 43)

- No preparation is required for “AV-IN1”.

Indications and buttons on the source control screen



Operation buttons

- [MODE]** Changes the AV-IN name.
- Press [◀] or [▶] to select an AV-IN name.
 - This setting does not affect the source name “AV-IN 1”/ “AV-IN 2” displayed on <Top Menu>.
- [MENU]** Displays the <Top Menu> screen.

Starting playback

- 1 Connect an external component to the AV-IN1 and iPod/AV-IN2 input terminals.
- 2 Select “AV-IN1” or “AV-IN2” as the source. (Page 9)
- 3 Turn on the connected component and start playing the source.

Using a rear view camera

- To use a rear view camera, a REVERSE lead connection is required. (Page 51)

Activating the rear view camera

- 1 Display the <Input> setting screen.

On the <Top Menu> screen:

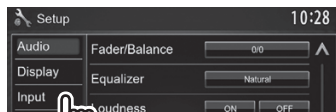

- 2

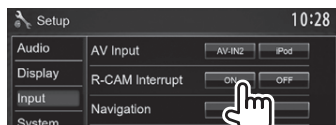

To deactivate: Select [Off] for <R-CAM Interrupt>.

Displaying the picture from the rear view camera

The rear view screen is displayed when you shift the gear to the reverse (R) position.



- To erase the caution message, touch the screen.

To display the picture from the rear view camera manually

DDX4025DAB/DDX4025BT/
DDX4055BT*1



(Hold)

DDX3025/DDX3055*2



(Hold)

DDX355*2



(Hold)

- When displaying the picture from the rear view camera manually, you can change the setting of the picture using [Zoom]/[Aspect]/[Adjust]. (Page 37)

To exit the rear view screen: Press and hold the same button again.

*1 This operation works only when <TEL Key Long Press> is set to [R-CAM]. (Page 44)

*2 This operation works only when <AUD Key Long Press> is set to [R-CAM]. (Page 44)

OTHER EXTERNAL COMPONENTS

Using the external navigation unit

You can connect a navigation unit (KNA-G620T; optional accessory) to the navigation input terminal so that you can view the navigation screen. (Page 52)

- The navigation guidance comes out of the front speakers even when you listen to an audio source.

❑ Viewing the navigation screen

On the **<Top Menu>** screen:

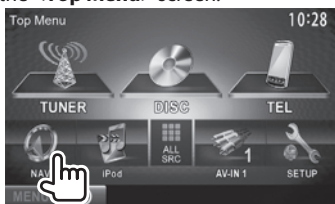

On the any screen:



- While the navigation screen is displayed, the touch panel operations are available only for navigation.
- The aspect ratio of the navigation screen is fixed to **<Full>** regardless of the **<Aspect>** setting (Page 38).

To exit the navigation screen

DDX4025DAB/DDX4025BT/
DDX4055BT/DDX3025/DDX3055



DDX355



❑ Settings for the navigation unit

1 Display the **<Input>** setting screen.

On the **<Top Menu>** screen:

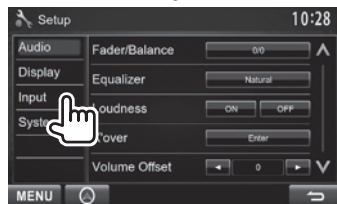

2 Display the **<Navigation>** screen.

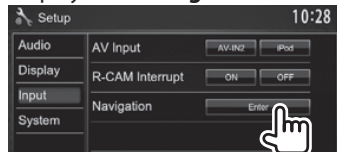

3



<Guidance> Select which front speakers are used for the navigation guidance.

<Volume> Adjust the volume of the navigation guidance. (0 to 35)

<NAV Mute> Select **[ON]** to attenuate the sound coming out of speakers other than the front speakers during navigation guidance.
• To cancel the attenuation, select **[OFF]**.

<NAV Setup> Press **[Enter]** to display the setup screen for the navigation unit. See the instruction manual supplied for the navigation unit.

BLUETOOTH (Only for DDX4025DAB/DDX4025BT/DDX4055BT)

Information for using Bluetooth® devices



Bluetooth is a short-range wireless radio communication technology for mobile devices such as mobile phones, portable PCs, and other devices. Bluetooth devices can be connected without cables and communicate with each other.

Notes

- While driving, do not perform complicated operations such as dialing numbers, using the phonebook, etc. When you perform these operations, stop your car in a safe place.
- Some Bluetooth devices may not connect to this unit depending on the Bluetooth version of the device.
- This unit may not work for some Bluetooth devices.
- Connecting conditions may vary depending on your environment.
- For some Bluetooth devices, the device is disconnected when the unit is turned off.

Connecting Bluetooth devices

❑ Registering a new Bluetooth device

When you connect a Bluetooth device to the unit for the first time, pair the unit and the device. Pairing allows Bluetooth devices to communicate with each other.

- The pairing method differs depending on the Bluetooth version of the device.
 - For devices with Bluetooth 2.1: You can pair the device and the unit using SSP (Secure Simple Pairing) which only requires confirmation.
 - For devices with Bluetooth 2.0: You need to enter a PIN code both on the device and unit for pairing.
- Once the connection is established, it is registered in the unit even if you reset the unit. Up to 5 devices can be registered in total.
- Only one device for Bluetooth phone and one for Bluetooth audio can be connected at a time.
- To use the Bluetooth function, you need to turn on the Bluetooth function of the device.
- To use the registered device, you need to connect the device to the unit. (Page 30)

Pairing a Bluetooth device using SSP (for Bluetooth 2.1)

When the Bluetooth device is compatible with Bluetooth 2.1, a pairing request is sent from an available device.

- 1 Search “**KENWOOD BT MM-8U2**” from your Bluetooth device.
- 2 Confirm the request both on the device and the unit.

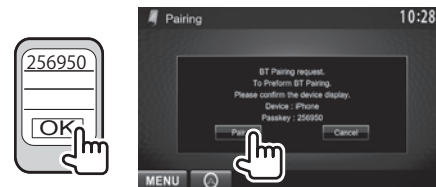

- Press [**Cancel**] to reject the request.

BLUETOOTH

Pairing a Bluetooth device using a PIN code (for Bluetooth 2.0)

- 1 Display the <Bluetooth Setup> screen.
On the <Top Menu> screen:

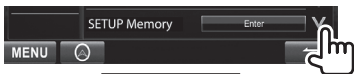
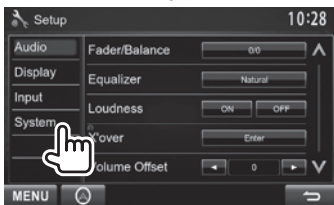

- 2 Change the PIN code.
 - If you skip changing the PIN code, go to step 3.
 - The PIN code is initially set to "0000".
 - The maximum number of digits in the PIN code is 16.

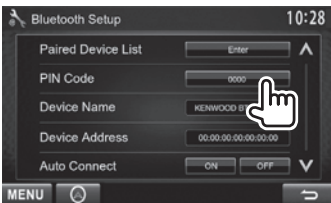

- 3 Search "KENWOOD BT MM-8U2" from your Bluetooth device.
 - Press [Clear] to delete the last entry.

- 4 Select the "KENWOOD BT MM-8U2" for your Bluetooth device.

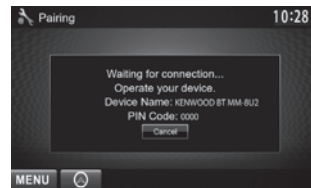
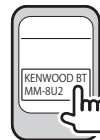

- If the PIN code is required, enter "0000" (initial).

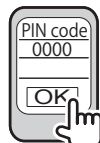

When pairing is complete, the device is listed on <Paired Device List>.

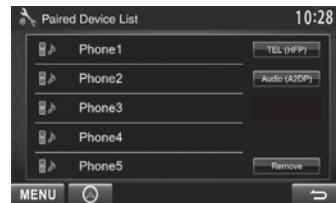

- To use the paired device, connect the device on <Paired Device List>. (Page 30)

BLUETOOTH

❑ Connecting a registered Bluetooth device

- 1 Display the <Bluetooth Setup> screen. (Page 29)
- 2

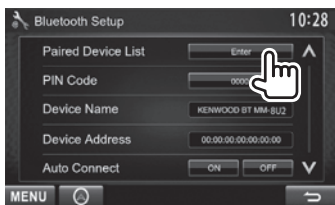

- 3 Select the device you want to connect (①), then select the usage of the device (②).



[TEL (HFP)]: for mobile phone

[Audio (A2DP)]: for Bluetooth audio player

- Selectable items depend on the device you are operating.
- If you connect a device while another device is connected, the device previously connected is disconnected and the connection for the device recently connected is established.

❑ Deleting a registered Bluetooth device

- 1 Display the <Bluetooth Setup> screen. (Page 29)
- 2

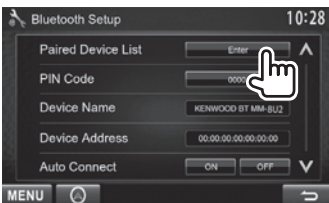

- 3 Select a device to delete (①), then delete the registration (②).



A confirmation message appears. Press [Yes].

Using the Bluetooth mobile phone

❑ Receiving a call

When a call comes in...

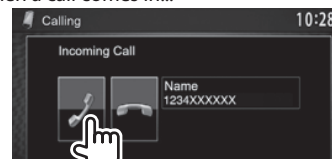

- Call information is displayed if acquired.
- Phone operation is not available while the picture from the rear view camera is displayed. (Page 26)

To reject a call

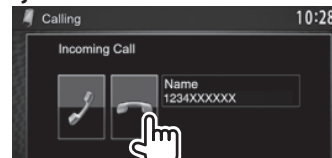

When <Auto Response> is set to [On] (Page 35)
The unit answers the incoming call automatically.

❑ Ending a call

While talking...

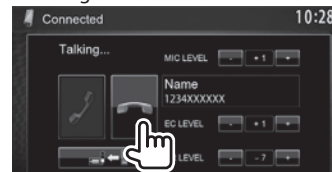

BLUETOOTH

❑ Adjusting the volume of calls/earpiece/microphone

While talking...





- You can adjust the volume level between -20 to +8 (initial: 0).
- This adjustment does not affect the volume level of the other sources.
- Use the monitor panel to adjust the call/earpiece volume. (Page 7)

❑ Switching between handsfree mode and phone mode

While talking...



Each time you press the button, the talking method is switched ( : handsfree mode /  : phone mode).

❑ Notifying SMS reception

If the mobile phone is compatible with SMS (Short Message Service), the unit tells you a message has been received. (Page 35)

- To read a received message, operate the mobile phone after stopping the car in a safe place.
 - You cannot read, edit, or send a message through the unit.
- For some mobile phones, the notification message may not be shown even if the SMS function is supported.

❑ Reducing noise/adjusting the echo cancel level

While talking...



- **To adjust the echo volume (between 1 to 10, initial: 4):** Adjust <EC LEVEL>.
- **To adjust the noise reduction volume (between -5 to -20, initial: -7) :** Adjust <NR LEVEL>.

❑ Making a call

- 1 Display the <Handsfree> screen. On the <Top Menu> screen:



- 2 Select a method to make a call.

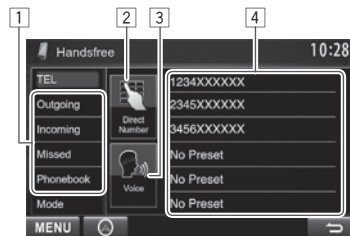

- 1 From the phone book/call lists
- 2 Direct number entry
- 3 Voice dialing
- 4 Preset list
 - To preset, see page 33.

BLUETOOTH

From the phone book/call lists

1



[Outgoing] From the dialed call list

[Incoming] From the received call list

[Missed] From the missed call list

[Phonebook] From the phone book

- To copy the phone book, see page 33.

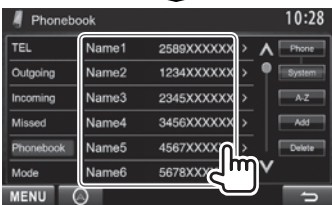

- You can change the page to display more items by pressing [▲]/[▼].

2



- To use the A to Z search on phone book:
When the <Phonebook> screen is displayed, you can search by initial.

1

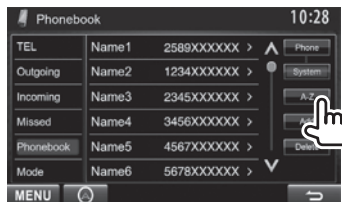

2 Select the initial.

- If the initial is not a letter or number, press **[Others]**.

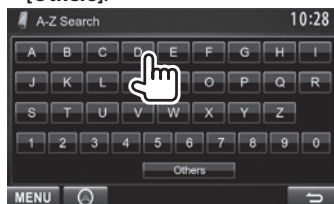

3 Select a phone number from the list.



- To display the details of an entry:
When the <Phonebook> is displayed, you can display the details of an entry and select a phone number if several phone numbers are registered.

1 Display the details of the desired entry.

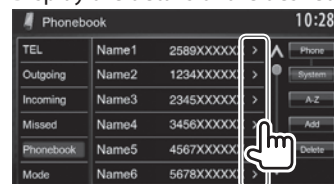

2 Select a phone number to call.

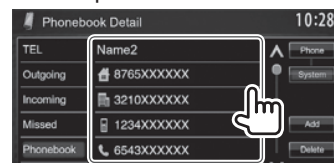

Direct number entry

You can enter up to 32 numbers.



- Press **[Clear]** to delete the last entry.
- Press and hold **[0+]** to add "+" to the phone number.
- Press **[Preset]** to save the entered phone number onto the preset list. (See the far left column.)

BLUETOOTH

Voice dialing

- Available only when the connected mobile phone has a voice recognition system.

1 Activate voice dialing.

On the **<Handsfree>** screen:



On the monitor panel:



2 Say the name of the person you want to call.

- If the unit cannot find the target, the following screen appears. Press **[Start]**, then say the name again.

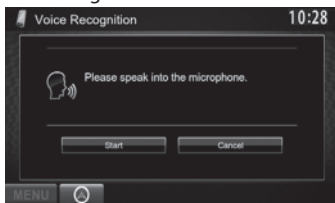

To cancel voice dialing: Press **[Cancel]**.

- * This operation works only when **<TEL Key Long Press>** is set to **[Voice]**. (Page 44)

❑ Presetting phone numbers

You can preset up to 6 phone numbers.

1 Display the **<Handsfree>** screen. (Page 31)

2 Select an item from the phone book/call lists. (Page 32)

3 Select a phone number.

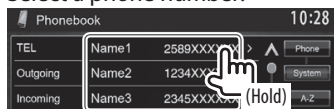

4 Select a preset number to store into.

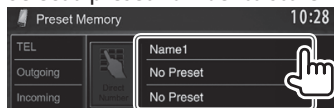

- You can also preset a phone number entered on the **<Direct Number>** screen by pressing **[Preset]**. (Page 32)

To delete the preset phone numbers: Initialize the settings from **<Initialize>** in **<Bluetooth Setup>**. (Page 44)

❑ Copying the phone book

You can copy the phone book memory of a mobile phone into the unit (up to 400 entries).

1 Display the **<Handsfree>** screen. (Page 31)

2

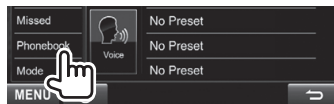

3

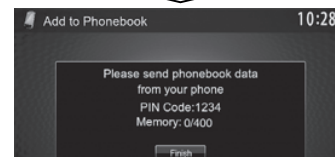
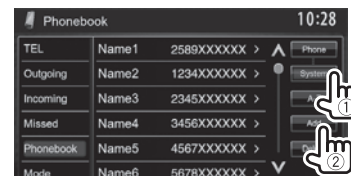

The PIN code (initial: 0000) necessary for copying the phonebook from the mobile phone and the numbers of the phone book entries copied are displayed.

4 Operate the target mobile phone.

- Refer to the instruction manual supplied with your mobile phone.
- To cancel the transfer, press **[Finish]**.

5 Finish the procedure.



The phone book memory is copied from the mobile phone.

BLUETOOTH

About mobile phones compatible with Phone Book Access Profile (PBAP)

If your mobile phone supports PBAP, you can display the phone book and call lists on the touch panel screen when the mobile phone is connected.

- Phone book: up to 5 000 entries
- Dialed calls, received calls, and missed calls: up to 50 entries each

To display the phone book/call lists of the mobile phone or the unit

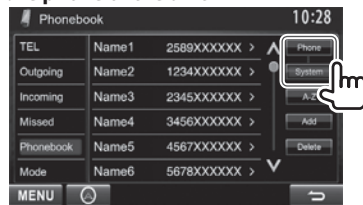

[Phone] Displays the phone book/call lists on the connected mobile phone.

[System] Displays the phone book/call lists copied to the unit.

❑ Deleting the phone number entries in the unit

1 Display the phone book/call list you want to delete. (Page 32)

2

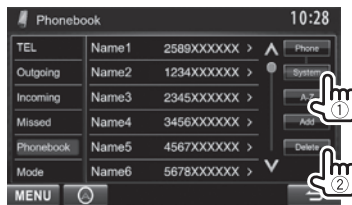

- You cannot delete data when **[Phone]** is selected.

3 Select the item you want to delete.

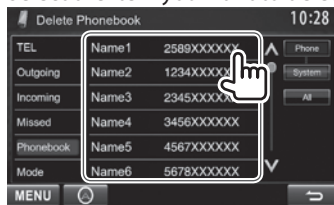

- Press **[All]** to delete all the numbers/names in the selected list.

A confirmation message appears. Press **[Yes]**.

Settings for Bluetooth mobile phones

1 Display the **<Handsfree>** screen. (Page 31)

2

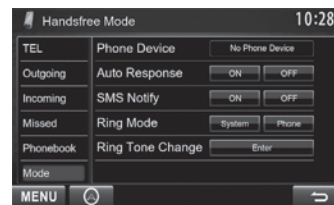

BLUETOOTH

□ Setting items

| | |
|--------------------|---|
| <Phone Device> | Shows the connected phone device name. |
| <Auto Response> | <ul style="list-style-type: none"> • ON: The unit answers the incoming calls automatically in 5 seconds. • OFF (Initial): The unit does not answer the calls automatically. Answer the calls manually. |
| <SMS Notify> | <ul style="list-style-type: none"> • ON: The unit informs you of the arrival of a message by ringing and displaying "Receiving Message". • OFF (Initial): The unit does not inform you of the arrival of a message. |
| <Ring Mode> | <ul style="list-style-type: none"> • System (Initial): The ring tone set on the unit is used. • Phone: The ring tone set on the mobile phone is used. (This function may not work depending on the mobile phone.) |
| <Ring Tone Change> | <p>When <Ring Mode> is set to <System>, press [Enter], then select the ring tone for received calls and SMS from <Tone1> (Initial), <Tone2>, <Tone3>.</p> <ul style="list-style-type: none"> • Call Tone: Selects the ring tone for phone calls. • Message Tone: Selects the ring tone for SMS. |

Using the Bluetooth audio player

- To register a new device, see page 28.
- To connect/disconnect a device, see page 30.

□ Indications and buttons on the source control screen

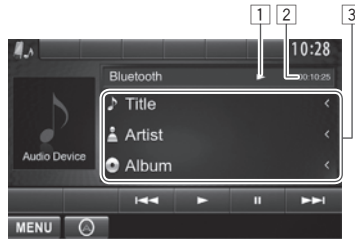

- The operation buttons, indications and information displayed on the screen differ depending on the connected device.

Playback information

- 1 Playback status (▶: play/||: pause)*
- 2 Playing time*
- 3 Tag data (current track title/artist name/album title)*
 - Pressing [←] scrolls the text if not all of the text is shown.

Operation buttons

- [||] Pauses playback.
- [▶] Starts playback.
- [◀◀] [▶▶]
 - Selects a track. (Press)
 - Reverse/forward search.* (Hold)
- [MENU] Displays the <Top Menu> screen.

* Available only for the devices compatible with AVRCP 1.3.

SETTINGS

Sound adjustment

Using the sound equalization

- The adjustment is memorized for each source until you adjust the sound again. If the source is a disc, the adjustment is stored for each of the following categories.

- DVD/VCD
- CD
- DivX/MPEG1/MPEG2/MP3/WMA/WAV/AAC

- You cannot adjust the sound when the unit is in standby.

Selecting a preset sound mode

- 1 Display the **<Equalizer>** screen.

On the **<Top Menu>** screen:

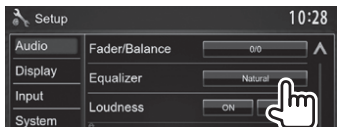

- 2 Select a sound mode.

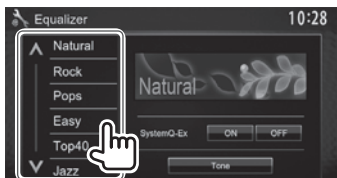

- You can change the page to display more items by pressing [▲]/[▼].

Storing your own adjustment—Customizing preset sound mode

- 1 Select a sound mode. (See the left column.)
- 2 Set **<SystemQ- Ex>** to **[OFF]** (①), then press **[Tone]** to display the **<Tone>** screen (②).

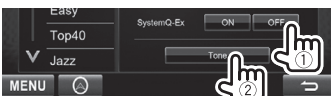

- 3 Select the band (①), adjust the level (②), then adjust the subwoofer level* (③).
 - Repeat steps ① and ② to adjust the level of other bands.



The adjustments are stored and **<User>** is activated.

- You can also display the **<Tone>** screen by pressing AUD (for DDX3025/DDX3055/DDX355) or by pressing the Volume/ATT/AUD knob (for DDX4025DAB/DDX4025BT/DDX4055BT) on the monitor panel.

* Adjustable only when the subwoofer is activated. (Page 42)

Storing your own adjustment—Adjusting the sound precisely

- 1 Select a sound mode. (See the far left column.)
- 2 Set **<SystemQ- Ex>** to **[ON]** (①), then press **[Tone]** to display the **<Tone>** screen (②).



- 3 Select the band (①), then adjust the sound (②).

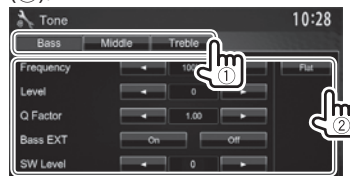

<Flat> Changes level of Bass/Middle/Treble to 0.

<Frequency> Selects frequency.

<Level> Adjust the level.

<Q Factor> Adjusts the width of the frequency.

<Bass EXT> Activates/deactivates bass.

<SW Level> Adjusts subwoofer level.*

The adjustments are overwritten if the **<User>** setting has been created (see the left column), and **<User>** is activated.

- To make adjustment for other bands, repeat step 3.

* Adjustable only when the subwoofer is activated. (Page 42)

SETTINGS

❑ Adjusting the crossover frequency

1 Display the <X'over> screen.

On the <Top Menu> screen:

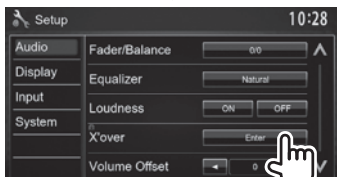

2 Select the item to adjust (①), then make adjustments (②).



- <HPF> Adjusts the crossover for the front ([Front]) or rear ([Rear]) speakers (high pass filter).
- <LPF> Adjusts the crossover for the subwoofer (low pass filter).*1
- <Level> Adjusts the subwoofer level.
- <Phase> Selects the phase for the subwoofer.*2
- <Freq> Adjusts the crossover frequency.

*1 Adjustable only when the subwoofer is activated. (Page 42)

*2 Not selectable when <Freq> is set to <Through>.

Adjustment for video playback

❑ Adjusting the picture

You can adjust the picture quality.

1 Display the adjustment menu.

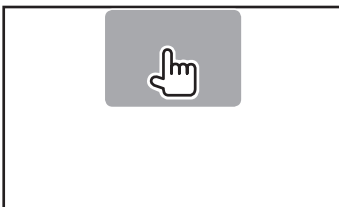

2 Select [DIM ON] (dimmer on) or [DIM OFF] (dimmer off).



3 Adjust the picture (-15 to +15).



- <Bright> Adjusts the brightness.
- <Contrast> Adjusts the contrast.
- <Black> Adjusts the blackness.
- <Color> Adjusts the color.
- <Tint>* Adjusts the tint.
- <Sharpness> Adjusts the sharpness.

* Adjustable only when the incoming signal is NTSC.

SETTINGS

❑ Changing the aspect ratio

You can change the aspect ratio for video playback.

1 Display the adjustment menu.

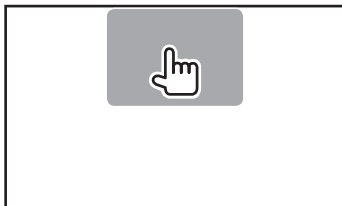

2 Select the aspect ratio.



- <FULL>*** For 16:9 original pictures

| | |
|------------|-------------|
| 4:3 signal | 16:9 signal |
| | |
- <JUST>** For viewing 4:3 pictures naturally on the wide screen

| | |
|------------|-------------|
| 4:3 signal | 16:9 signal |
| | |
- <Normal>*** For 4:3 original pictures

| | |
|------------|-------------|
| 4:3 signal | 16:9 signal |
| | |
- <Auto>** For "DISC"/"USB" only: The aspect ratio is automatically selected to match the incoming signals.

* While DivX is played back with **<Screen Ratio>** set to [16:9] (for disc: Page 13/for USB: Page 15), the aspect ratio is not set correctly.

❑ Zooming the picture

You can zoom the picture (<FULL>, <Zoom1> to <Zoom3>).

- When **<Aspect>** is set to **<JUST>** or **<Auto>** (see the left column), the picture is zoomed with the aspect ratio of the **<FULL>** setting.

1 Display the adjustment menu.

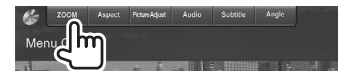

2 Change the magnification (①), then move the zooming frame (②).



- The zoom function cannot be used for some video sources.

SETTINGS

Changing display design

You can change the background and panel color.

- 1 Display the <User Customize> screen.

On the <Top Menu> screen:

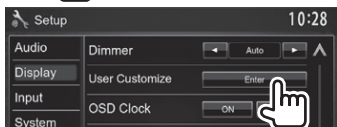
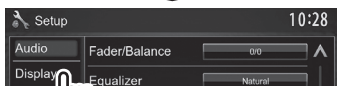
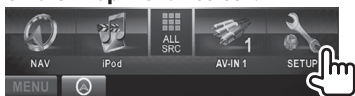

- 2 Select an item to change ([Background] or [Panel Color]).



- 3 Select a background/panel color.
To select a background



To select a panel color



- Selecting [Scan] changes the illumination color gradually.

*1 Store your own scene beforehand. (See the right column.)

*2 Store your own color adjustment beforehand. (See below.)

❑ Making your own color adjustment

- 1 Select [Panel Color] on the <User Customize> screen. (See the left column.)

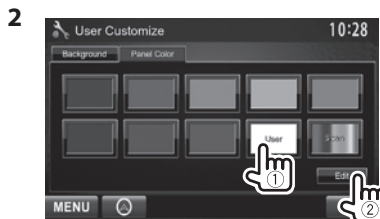

- 3 Select the dimmer setting for the color (①), then adjust the color (②).



❑ Storing your own scene for the background image

While playing a video or JPEG, you can capture an image and use the captured image as a background.

- You cannot capture copyrighted content and images from iPod/iPhone.
- When using a JPEG file as the background, make sure that the resolution is 800 x 600 pixels.
- The color of the captured image may look different from that of the actual scene.

- 1 Play a video or JPEG.
- 2 Display the <User Customize> screen. (See the far left column.)



- 3 Adjust the image.



- ▶▶▶* Starts/pauses playback.
- ▶▶* Advances scenes frame-by-frame.
- 🔍 Magnifies the scene. (<OFF>, <Zoom1> – <Zoom3>)
- ⏪|⏩|⏮|⏭|⏭|⏭ Moves the zooming frame.

- To cancel the capture, press [Cancel].

Continued to the next page...

SETTINGS

- 5 Capture the image displayed on the screen.



A confirmation message appears. Press **[Yes]** to store the newly captured image. (The existing image is replaced with the new one.)

- Press **[No]** to return to the previous screen.

* Not displayed when playing an external component connected to the AV-IN1 or iPod/AV-IN2 input terminal.

Customizing the <Top Menu> screen

You can arrange the items to display on the <Top Menu> screen.

- 1 Display the <Menu Customize> screen. On the <Top Menu> screen:

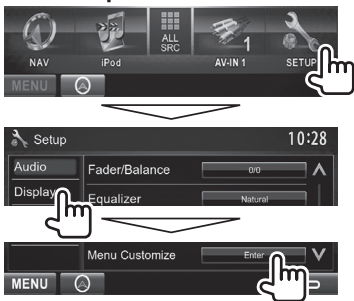

- 2 Select the position to place the icon (①), then select the item you want to display on the selected position (②).



Repeat this step to place icons for other items.

Customizing the system settings

Memorizing/recalling the settings

- You can memorize the settings changed in the <Setup> menu and recall the memorized settings anytime.
- The memorized settings are kept even when the unit is reset.

- 1 Display the <SETUP Memory> screen. On the <Top Menu> screen:



2



- To cancel, press **[No]**.

- 3 Select an operation.



- [Recall]** Recalls the memorized settings.
- [Memory]** Memorizes the current settings.
- [Clear]** Clears the currently memorized settings.

- To cancel, press **[Cancel]**.

Confirmation message appears. Press **[Yes]**.

SETTINGS

❑ Locking the settings

You can lock the settings to prevent them from being changed.

-  is shown beside the settings that can be locked.

1 Display the **<SETUP Memory>** screen. (Page 40)

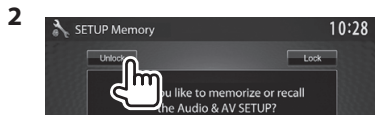

To unlock the setting: Press **[Unlock]**.

❑ Updating the system

You can update the system by connecting a USB device containing an update file.

- For updating the system, visit <http://www2.jvckenwood.com/cs/ce/>.

1 Create an update file, copy it to a USB device, and connect it to the unit.

- To connect a USB device, see page 52.

2 Display the **<System Information>** screen.

On the **<Top Menu>** screen:

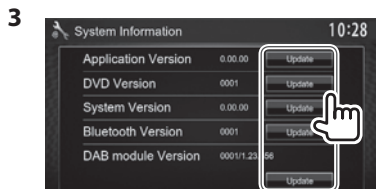
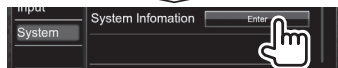
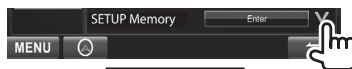
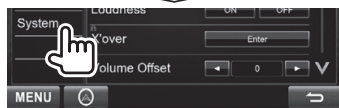

- <Application Version>** Updates the system application.
- <DVD Version>** Updates the DVD system application.
- <System Version>** Updates the system.
- <Bluetooth Version>***1 Updates the Bluetooth application.
- <DAB module Version>***2 Updates the Digital Radio (DAB) module application.

It may take a while.

If the update has been completed successfully, "Update Completed" appears. Reset the unit.

- If the update has failed, turn the power off and then on, and retry the update.
- Even if you have turned off the power during the update, you can restart the update after the power is turned on. The update will be performed from the beginning.

*1 Only for DDX4025DAB/DDX4025BT/DDX4055BT.

*2 Only for DDX4025DAB.

❑ Adjusting the touch position

You can adjust the touch position on the touch panel if the position touched and the operation performed do not match.

1 Display the **<Setup>** setting screen. (See the far left column.)

2 Display the **<Touch Panel Adjust>** screen.

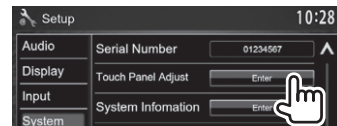
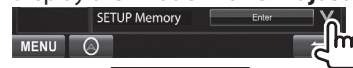

3 Touch the center of the marks at the lower left and at the upper right as instructed.

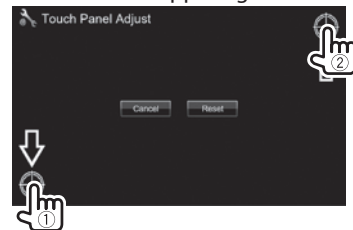

- To reset the touch position, press **[Reset]**.
- To cancel the current operation, press **[Cancel]**.

SETTINGS

Setting menu items

□ Displaying the <Setup> menu screen

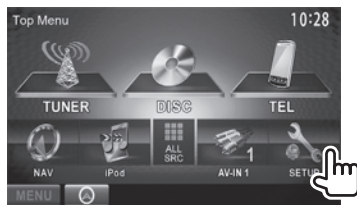

- You cannot change the <Audio> settings screen when [STANDBY] is selected on the <Top Menu>. (page 7)
- You can change the <DAB setup> in the <System> setting only when [STANDBY] is selected on the <Top Menu>. (page 7)

□ <Audio> setting screen

<Fader/Balance>



Fader: Adjust the front and rear speaker output balance.

- **F6 to R6** (Initial: **0**)
 - When using a two-speaker system, set the fader to the center (**0**).

Balance: Adjust the left and right speaker output balance.

- **L6 to R6** (Initial: **0**)
 - Press [**▲**]/[**▼**]/[**◀**]/[**▶**] or drag [**+**] to adjust.
 - To clear the adjustment, press [**Center**].

<Equalizer>

Change the sound mode or adjust and store the equalization for each source. (Page 36)

- **Natural** (Initial)/**Rock/Pops/Easy/Top40/Jazz/ User**

<Loudness>

You can activate/deactivate loudness.

- **ON** (Initial): Boost low and high frequencies to produce a well-balanced sound at a low volume level. The LOUD indicator lights up.
- **OFF:** Cancels.

<X'over>

Adjust the crossover frequency. (Page 37)

<Volume Offset>

Adjust and store the auto-adjustment volume level for each source. (For discs, the adjustment is stored for each of the following categories: DVD/VCD, CD, and DivX/MPEG1/MPEG2/MP3/WMA/WAV/AAC.) The volume level will automatically increase or decrease when you change the source.

– **-15 to +6** (Initial: **0**)

<Subwoofer>

- **ON** (Initial): Activates the subwoofer.
- **OFF:** Deactivates the subwoofer.

<Speaker Select>

Select the size of the connected speaker.

- **Standard** (Initial)/**Narrow/Middle/Wide**

SETTINGS

☐ <Display> setting screen

<Dimmer>

- **Auto** (Initial): Dims the screen and button illumination when you turn on the headlights.
 - The ILLUMI lead connection is required. (Page 51)
- **ON**: Activates dimmer.
- **OFF**: Cancels.
- **NAV**: Activates or deactivates dimmer according to the day/night display setting of the connected navigation unit.

<User Customize>

Change the display design (background and panel color). (Page 39)

<OSD Clock>

- **ON**: Displays the clock while a video source is played back.
- **OFF** (Initial): Cancels.

<Scroll>

- **ON** (Initial): Repeats scrolling.
- **Once**: Scrolls the displayed information once.
- **OFF**: Cancels.

Pressing [**<**] scrolls the text regardless of this setting.

<Menu Customize>

Change the items to display on the <Top Menu> screen. (Page 40)

<Screen Adjust>

Adjust the brightness and blackness of the screen. Press [**Enter**] to display the setting screen, select [**DIM ON**] (dimmer on)/[**DIM OFF**] (dimmer off), then change the following settings:

- **Bright**: Adjusts brightness.
 - **-15** to **+15** (Initial: **0** for Dimmer On/**+15** for Dimmer Off)
- **Black**: Adjusts blackness.
 - **-15** to **+15** (Initial: **0**)

<Video Output>*

Select the color system of the external monitor.

- **NTSC, PAL** (Initial)

* "Please Power Off" appears when the setting is changed. Turn off the power, then turn on to enable the change.

☐ <Input> setting screen

<AV Input>

You can determine the use of the iPod/AV-IN2 input terminal.

- **AV-IN2**: Select to use the AV component connected to the iPod/AV-IN2 input terminal. (Page 52)
- **iPod** (Initial): Select to use the iPod/iPhone connected using the USB Audio/Video cable for iPod/iPhone. (Page 52)

<R-CAM Interrupt>

- **ON**: Displays the picture from the rear view camera when you shift the gear to the reverse (R) position.
- **OFF** (Initial): Select this when no camera is connected.

<Navigation>

Change the navigation settings. (Page 27)

SETTINGS

<System> setting screen

<Language>*1

Select the text language used for on-screen information.

- **English** (initial for DDX4025DAB/DDX4025BT/DDX3025)/**Spanish/French/German/Italian/Dutch/Russian** (initial for DDX4055BT/DDX3055/DDX355)/**Portuguese/Chinese-Simplified/Chinese-Traditional/Thai/Turkish/Arabic/Persian/Hebrew/Greek/Indonesia/Korean**
 - For external monitors, only English/Spanish/French/German/Italian/Dutch/Russian/Portuguese are available. If another language has been selected, the text language for external monitors will be set to English.
- **GUI Language:** Select a language used for displaying operation buttons and menu items.
 - **English** (Initial)/**Local** (the language selected above)

<Clock>

Adjust the clock time. (Page 5)

<Beep>

- **ON** (Initial): Activates the key-touch tone.
- **OFF:** Cancels.

<Remote Sensor>

- **ON** (Initial): Activates the remote sensor.
- **OFF:** Cancels.

<SETUP Memory>

You can memorize, recall, or clear the settings you have made. (Page 40)

<Bluetooth Setup>*2

Configure settings for using a Bluetooth device, such as connection and other general operations.

- **Paired Device List:** Press **[Enter]** to show the list of the registered devices. You can connect the device or delete the registration. (Page 30)

- **PIN Code:** Changes the PIN code of the unit. (Page 29)
- **Device Name:** Shows the device name to be shown on the Bluetooth device—KENWOOD BT MM-8U2.
- **Device Address:** Shows the device address of the unit.
- **Auto Connect:**
 - **ON** (Initial): The connection is automatically established with the last connected Bluetooth device when the unit is turned on.
 - **OFF:** Cancels.
- **Bluetooth HF/Audio:** Select the speakers used for Bluetooth (both phone and audio player).
 - **Front Only** (Initial): From front speakers only.
 - **All:** From all speakers.
- **Auto Pairing:**
 - **ON** (initial): Establishes the pairing automatically with the connected iOS device (such as iPhone) even if the Bluetooth function is deactivated on the device. (Auto pairing may not work for some devices depending on the iOS version.)
 - **OFF:** Cancels.
- **Initialize:** Hold **[Enter]** to initialize all settings you have made for using Bluetooth mobile phone and Bluetooth audio player.

<DAB Setup>

• **L-Band Tuning:**

- **ON:** Receives the L-Band width during Digital Audio reception.
- **OFF** (initial): Cancels

• **Antenna Power:**

- **ON** (initial): Supplies the power to the DAB aerial.
- **OFF:** Cancels

<TEL Key Long Press>*2

Assigns the function of the TEL button when held.

- **V-OFF:** Turns off the screen. (Page 8)
- **VOICE** (initial): Activates voice dialing. (Page 33)
- **R-CAM:** Displays the picture from the rear view camera. (Page 26)

<AUD Key Long Press>*3

Assigns the function of the AUD button when held.

- **V-OFF** (initial): Turns off the screen. (Page 8)
- **R-CAM:** Displays the picture from the rear view camera. (Page 26)

<DivX® VOD>

This unit has its own Registration Code. Once you have played back a file with the Registration Code recorded, this unit's Registration Code is overwritten for copyright protection.

- Press **[Enter]** to display the information.
- To return to the previous screen, press **[OK]**.

<SI>

Activate or deactivate the security function. (Page 4)

<Serial Number>

Displays the serial number.

<Touch Panel Adjust>

Adjust the touch position of the buttons on the screen. (Page 41)

<Security Code>

Register the security code for the unit. (Page 4)

<System Information>

Displays the version information of the software. You can update the software. (Page 41)

*1 "Please Power Off" appears when the setting is changed. Turn off the power, then turn on to enable the change.

*2 Only for DDX4025DAB/DDX4025BT/DDX4055BT.

*3 Only for DDX3025/DDX3055/DDX355.

REMOTE CONTROLLER

Overview

Optional Remote Controller KNA-RCDV331 is designed for controlling this unit. Refer to the instruction manual that comes with the remote controller.

⚠ Caution:

- Put the Remote Controller in a place where it will not move during braking or other operations. A dangerous situation could result if the Remote Controller falls down and gets wedged under the pedals while driving.
- Do not leave the battery near fire or under direct sunlight. A fire, explosion or excessive heat generation may result.
- Do not recharge, short, break up or heat the battery or place it in an open fire. Such actions may cause the battery to leak fluid. If spilled fluid comes in contact with your eyes or on clothing, immediately rinse with water and consult a physician.
- Place the battery out of reach of children. In the unlikely event that a child swallows the battery, immediately consult a physician.

❑ Battery installation

Use two "AAA"/"R03"-size batteries. Insert the batteries with the + and - poles aligned properly, following the illustration inside the case.

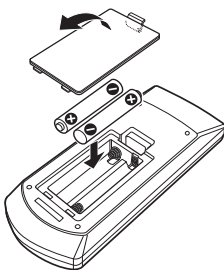

- If the Remote Controller operates only over shorter distances or does not operate at all, it is possible that the batteries are depleted. In such instances, replace both batteries with new ones.

❑ Remote Controller mode switch

The functions operated from the remote controller differ depending on the position of the mode switch.

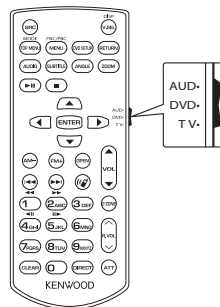

AUD mode: Switch to this mode when controlling a selected source or tuner source, etc.

DVD mode: Switch to this mode when playing DVDs or CDs etc. with the player integrated in this unit.

TV mode: Not used.

- The position of the remote control mode switch is indicated in the title of each mode, e.g., "(AUD mode)".
- When controlling a player that is not integrated in the unit, select "AUD" mode.

REMOTE CONTROLLER

Operations from the remote controller

Common operations (AUD mode)

Source switching

Switches to the source to be played.
Hangs up the incoming/current call.

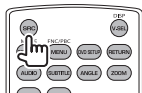

Volume control

Adjusts the volume.

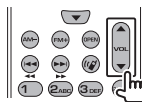

Volume attenuating

Press the key once to lower the volume. Press again to restore the previous volume.

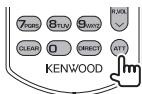

NAV/V.SEL

Switches to the navigation screen.

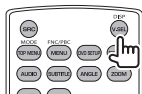

ENTER

Enters options.

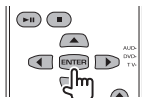

Hands-free communication

When a call comes in, it answers the call.

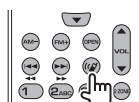

Function

Switches the control screen.

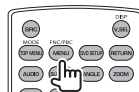

MODE

Switches the aspect ratio. Aspect ratio changes each time you press this key.

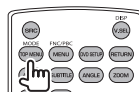

DVD/VCD (DVD mode)

Cursor key

Moves the cursor when displaying a menu.

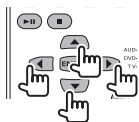

Track search and file search

Selects the track or file to be played.



Play/Pause

Pauses the track. Press again to resume playing.



Stop

Stops and memorizes the point where the disc stops.



Direct search

Pressing this key switches the features that can be searched for directly.



- DVD-VIDEO
 - Chapter number
 - Title number
 - Cancel
- VCD 1.X, VCD 2.X (PBC OFF)
 - Track number
 - Cancel
- VCD 2.X (PBC ON)
 - Track number
 - Cancel

Once you have switched to the direct search feature, specify the search number from the numeric keypad, and then press the [ENTER] key.

REMOTE CONTROLLER

Numeric keypad

- Specify the number to search for in direct search.
- Press **1** **2** to fast forward/backward. Switches the fast forward/backward speed each time you press this key.
- Press **1** **2** to slow forward/backward during pause.

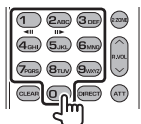

DVD Top Menu

Returns to the DVD top menu.

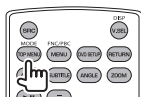

DVD Menu

Displays the DVD menu.

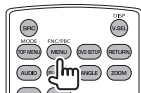

SUBTITLE

Switches the subtitle language.

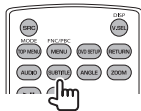

ZOOM

Switches the zoom ratio each time you press this key.

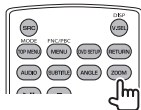

Picture Angle

Switches the picture angle each time you press this key.

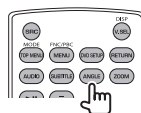

AUDIO

Switches the voice language each time you press this key.

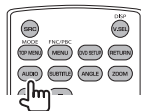

Music Disc/Audio file/Video file/Picture file (AUD mode)

Folder search

Selects the folder to be played.



Track search and file search

Selects the track or file to be played.



Play/Pause

Pauses the track.
Press again to resume playing.



Direct search

Pressing this key switches the features that can be searched for directly.

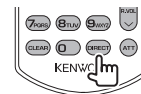

- Music Disc
 - Track number
 - Cancel
- Audio files in DVD/CD disc
 - Folder number
 - File number
 - Cancel

Once you have switched to the direct search feature, specify the search number from the numeric keypad, and then press the [ENTER] key.

Numeric keypad

Specify the number to search for in direct search.

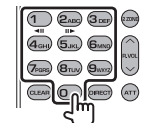

REMOTE CONTROLLER

Radio (AUD mode)

Band switching

Switches to bands received by the unit.



Station selection

Switches to broadcast stations received by the unit.

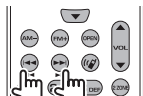

Seek mode switching

Switches the Seek mode (AUTO1, AUTO2, MANU).



Direct tuning

After pressing this key, use the keypad to specify the broadcast station you wish to receive.

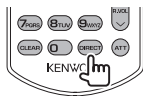

Example: 92.1 MHz (FM)

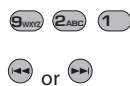

Example: 810 kHz (AM)

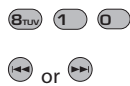

Numeric keypad

- To use preset tuning, press the number of a programmed broadcast station. (1 - 6 MEMO)
- Press the direct tuning key first, then specify the frequency of the station to receive.



Digital Radio (DAB) (AUD mode)

Service selection

Switches to broadcast services received by the unit.



Seek mode switching

Switches the Seek mode (AUTO1, AUTO2, MANU).



Numeric keypad

To use preset tuning, press the number of a programmed broadcast service.



iPod (AUD mode)

Music/Video search

Selects the music/video to be played.



Play/Pause

Pauses the music/video. Press again to resume playing.



USB (AUD mode)

Folder search

Selects the folder to be played.



File search

Selects the file to be played.



Play/Pause

Pauses the file. Press again to resume playing.



CONNECTION/INSTALLATION

Before installing the unit

⚠ WARNING

- If you connect the ignition wire (red) and the battery wire (yellow) to the car chassis (ground), you may cause a short circuit, that in turn may start a fire. Always connect those wires to the power source running through the fuse box.
- Do not cut out the fuse from the ignition wire (red) and the battery wire (yellow). The power supply must be connected to the wires via the fuse.

⚠ Precautions on installation and connection

- Mounting and wiring this product requires skills and experience. For best safety, leave the mounting and wiring work to professionals.
- Make sure to ground the unit to a negative 12 V DC power supply.
- Do not install the unit in a spot exposed to direct sunlight or excessive heat or humidity. Also avoid places with too much dust or the possibility of water splashing.
- Do not use your own screws. Use only the screws provided. If you use the wrong screws, you could damage the unit.
- If the power is not turned on ("Miswiring DC Offset Error", "Warning DC Offset Error" is displayed), the speaker wire may have a short circuit or have touched the chassis of the vehicle and the protection function may have been activated. Therefore, the speaker wire should be checked.

- If your car's ignition does not have an ACC position, connect the ignition wires to a power source that can be turned on and off with the ignition key. If you connect the ignition wire to a power source with a constant voltage supply, such as with battery wires, the battery may be drained.
- If the fuse blows, first make sure the wires are not touching to cause a short circuit, then replace the old fuse with one with the same rating.
- Insulate unconnected wires with vinyl tape or other similar material. To prevent a short circuit, do not remove the caps on the ends of the unconnected wires or the terminals.
- Connect the speaker wires correctly to the terminals to which they correspond. The unit may be damaged or fail to work if you share the ⊖ wires or ground them to any metal part in the car.
- When only two speakers are being connected to the system, connect both connectors either to the front output terminals or to the rear output terminals (do not mix front and rear). For example, if you connect the ⊕ connector of the left speaker to a front output terminal, do not connect the ⊖ connector to a rear output terminal.
- After the unit is installed, check whether the brake lamps, blinkers, wipers, etc. on the car are working properly.
- Mount the unit so that the mounting angle is 30° or less.
- Do not press hard on the panel surface when installing the unit to the vehicle. Otherwise scars, damage, or failure may result.

⚠ CAUTION

Install this unit in the console of your vehicle. Do not touch the metal part of this unit during and shortly after the use of the unit. Metal parts such as the heat sink and enclosure become hot.

▣ Supplied accessories for installation

- ① Wiring harness x 1
- ② Trim plate x 1
- ③ Extension wire x 1
- ④ Extraction keys x 2
- ⑤ Microphone x 1 *

* Only for DDX4025DAB/DDX4025BT/DDX4055BT.

CONNECTION/INSTALLATION

□ Installation procedure

- 1 To prevent a short circuit, remove the key from the ignition and disconnect the ⊖ battery.
- 2 Make the proper input and output wire connections for each unit.
- 3 Connect the speaker wires of the wiring harness.
- 4 Take Connector B on the wiring harness and connect it to the speaker connector in your vehicle.
- 5 Take Connector A on the wiring harness and connect it to the external power connector in your vehicle.
- 6 Connect the wiring harness connector to the unit.
- 7 Install the unit in your car.
 - Make sure that the unit is installed securely in place. If the unit is unstable, it may malfunction (eg, the sound may skip).
- 8 Reconnect the ⊖ battery.
- 9 Press the reset button.
- 10 Configure <Initial Settings>. (Page 4)

Installing the unit

□ Installing the unit

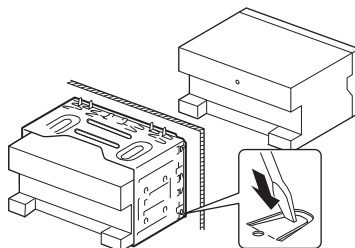

- Bend the tabs of the mounting sleeve with a screwdriver or similar utensil and attach it in place.

□ Installing the trim plate

Attach the trim plate (2).

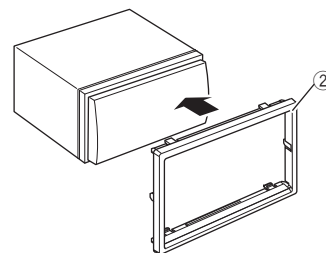

CONNECTION/INSTALLATION

Connection

Connecting wires to terminals

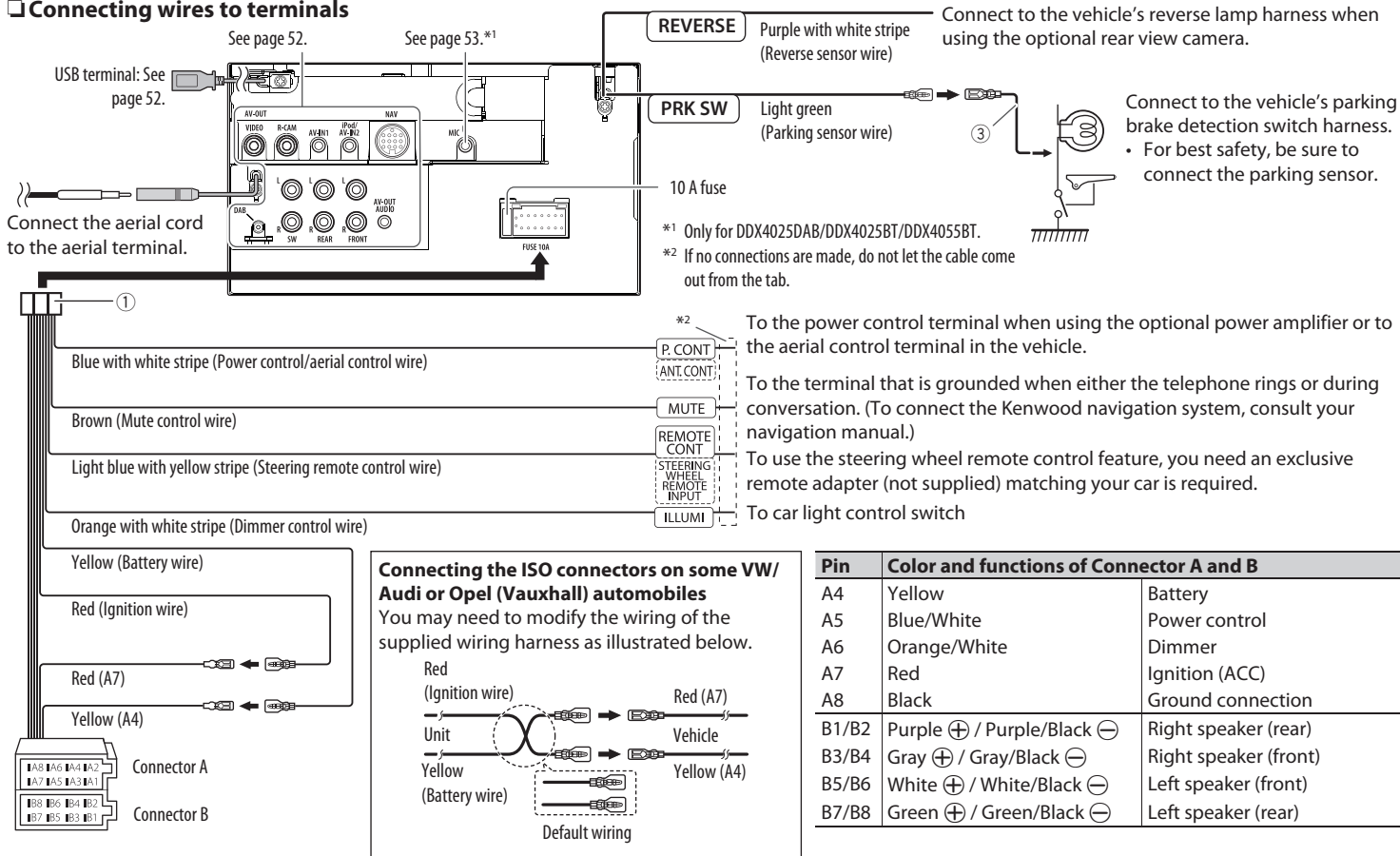

CONNECTION/INSTALLATION

Connecting a USB device/iPod/iPhone

For DDX4025DAB/DDX4025BT/DDX4055BT/
DDX3025/DDX3055

**iPhone 5/iPod touch
(5th Generation)/iPod
nano (7th Generation)**
(commercially available)

**iPod/iPhone except for
iPhone 5/iPod touch
(5th Generation)/iPod
nano (7th Generation)**
(commercially available)

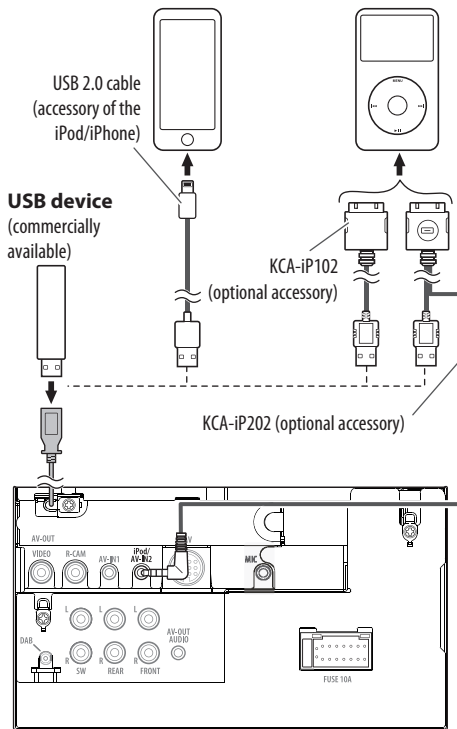

For DDX355

**iPod/iPhone except for
iPhone 5/iPod touch
(5th Generation)/iPod
nano (7th Generation)**
(commercially available)

**iPhone 5/iPod touch
(5th Generation)/
iPod nano (7th
Generation)**
(commercially available)

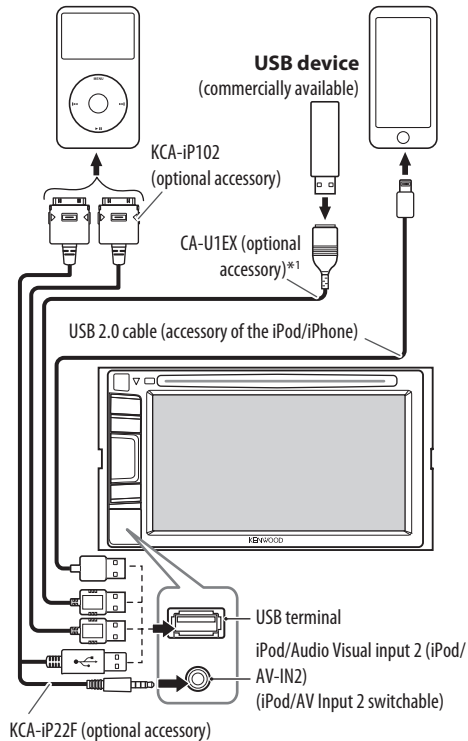

*1 Use CA-U1EX for extending the cable if necessary. (Max 500 mA, 5V)

Connecting external components

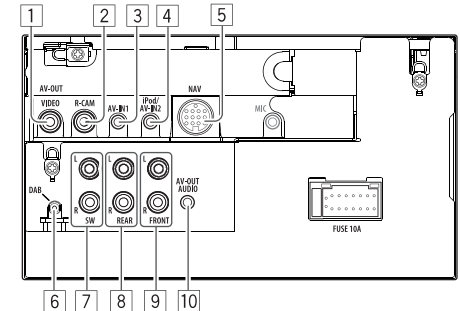

- 1 AV-OUT/Video output (Yellow)
- 2 Rear view camera input (Yellow)
- 3 Audio Video input (AV-IN1)*2
- 4 iPod/Audio Visual input (iPod/AV-IN2)*2
- 5 NAVI I/F input
- 6 DAB antenna input*3
- 7 Subwoofer preout (monaural output)
 - Subwoofer left output (White)
 - Subwoofer right output (Red)
- 8 Rear preout
 - Audio left output (White)
 - Audio right output (Red)
- 9 Front preout
 - Audio left output (White)
 - Audio right output (Red)
- 10 Audio output (ø3.5 mini jack)
Resistance-free stereo type mini plug

*2 When connecting the component to play on "AV-IN1" or "AV-IN2", use the Audio and Video cable CA-C3AV (optional accessory).

*3 Only for DDX4025DAB. To use the digital radio, connect CX-DAB1 (optional accessory).

CONNECTION/INSTALLATION

❑ Connecting microphone for Bluetooth (only for DDX4025DAB/DDX4025BT/DDX4055BT)

Connect the microphone (5) to MIC terminal.

- To install the microphone, peel off the adhesive tape, fix on the installation position, then adjust the direction of the microphone to face the driver. After installing, fix the microphone cable to the car with clamps (commercially available).

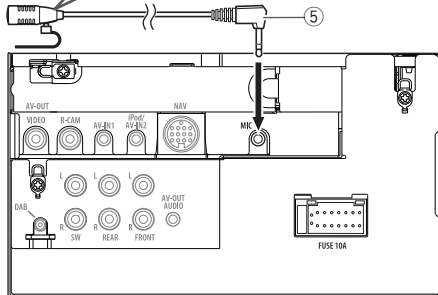
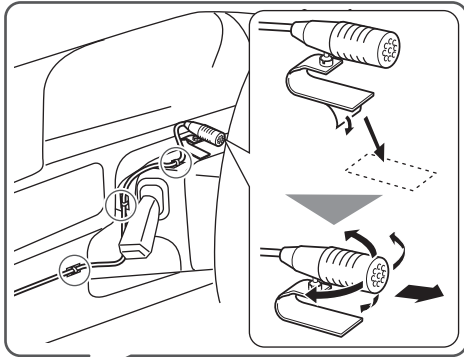

Removing the unit

❑ Removing the trim plate

- 1 Engage the catch pins on the extraction key (4) and remove the two locks on the lower part. Lower the frame and pull it forward.

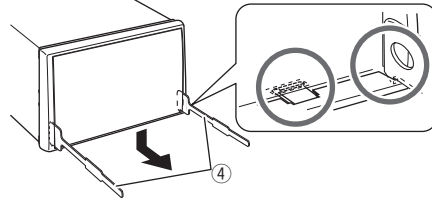

- 2 Remove the upper two locations.

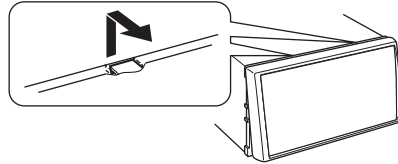

- The frame can be removed from the top side in the same manner.

❑ Removing the unit

- 1 Remove the trim plate. (See the left column.)
- 2 Insert the two extraction keys (4), then pull them as illustrated so that the unit can be removed.

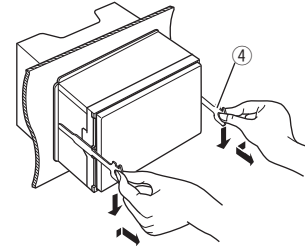

- Be careful to avoid injury from the catch pins on the extraction key.

REFERENCES

Maintenance

❑ Caution on cleaning the unit

Do not use any solvent (for example, thinner, benzine, etc.), detergent, or insecticide. This may damage the monitor or the unit.

Recommended cleaning method:

Gently wipe the panel with a soft, dry cloth.

❑ Moisture condensation

Moisture may condense on the lens inside the unit in the following cases:

- After starting the heater in the car.
- If it becomes very humid inside the car.

Should this occur, the unit may malfunction. In this case, eject the disc and leave the unit turned on for a few hours until the moisture evaporates.

❑ How to handle discs

- When removing a disc from its case, press down the center holder of the case and lift the disc out, holding it by the edges.



- Always hold the disc by the edges. Do not touch its recording surface.
- When storing a disc in its case, gently insert the disc around the center holder (with the printed surface facing up).
 - Make sure to store discs in their cases after use.

❑ To keep discs clean

A dirty disc may not play correctly.

If a disc does become dirty, wipe it with a soft cloth in a straight line from center to edge.



- Do not use any solvents (for example, conventional record cleaner, spray, thinner, benzine, etc.) to clean discs.

❑ To play new discs

New discs may have some rough spots around the inner and outer edges. If such a disc is used, this unit may reject the disc.



- To remove these rough spots, rub the edges with a pencil or ball-point pen, etc.

More information

❑ File playback

Playing DivX files

- This unit can play back DivX files with the extension code <.divx>, <.div>, or <.avi> (regardless of the letter case—upper/lower).
- Audio stream should conform to MP3 or Dolby Digital.
- The file encoded in the interlaced scanning mode may not be played back correctly.
- The maximum bit rate for video signals (average) is 4 Mbps.

Playing MPEG1/MPEG2 files

- This unit can play back MPEG1/MPEG2 files with the extension code <.mpg>, <.mpeg>, or <.mod>.
- The stream format should conform to MPEG system/program stream.
The file format should be MP@ML (Main Profile at Main Level)/SP@ML (Simple Profile at Main Level)/MP@LL (Main Profile at Low Level).
- Audio streams should conform to MPEG1 Audio Layer-2 or Dolby Digital.

Playing JPEG files

- This unit can play back JPEG files with the extension code <.jpg> or <.jpeg>.
- This unit can play back JPEG files that are at 32 x 32 to 8 192 x 7 680 resolution.
It may take time to display the file depending on its resolution.
- This unit can play back baseline JPEG files.
Progressive JPEG files or lossless JPEG files cannot be played.

REFERENCES

Playing MP3/WMA/WAV/AAC files

- This unit can play back files with the extension code <mp3>, <.wma>, <.wav> or <.m4a> (regardless of the letter case—upper/lower).
- This unit can play back the files meeting the conditions below:
 - Bit rate:
 - MP3: 8 kbps – 320 kbps
 - WMA: 5 kbps – 320 kbps
 - AAC: 16 kbps – 320 kbps
 - Sampling frequency:
 - 8 kHz – 48 kHz (for MP3/WMA)
 - 44.1 kHz (for WAV)
 - 32 kHz – 48 kHz (for AAC)
- This unit can show ID3 Tag Version 1.0/1.1/2.2/2.3/2.4 (for MP3).
- This unit can also show WAV/WMA/AAC Tag.
- This unit can play back files recorded in VBR (variable bit rate).
- Files recorded in VBR have a discrepancy in elapsed time indication.
- This unit cannot play back the following files:
 - MP3 files encoded with MP3i and MP3 PRO format.
 - MP3 files encoded with Layer 1/2.
 - WMA files encoded with lossless, professional, and voice format.
 - WMA files which are not based upon Windows Media® Audio.
 - WMA/AAC files copy-protected with DRM.
 - AAC files encoded by using any other application than iTunes.
 - AAC files copy-protected with FairPlay (except those stored on an iPod).
 - Files which have the data such as AIFF, ATRAC3, etc.

- This unit can display the jacket picture meeting the conditions below:
 - Picture size: 32 x 32 to 1 232 x 672 resolution
 - Data size: less than 650 KB.
 - File type: JPEG

Disc playback

Playable disc types

| Disc type | Recording format, file type, etc. |
|---|--|
| DVD <ul style="list-style-type: none"> • DTS sound cannot be reproduced or emitted from this unit. | DVD Video* ¹ |
| DVD Recordable/Rewritable (DVD-R/-RW*², +R/+RW*³) <ul style="list-style-type: none"> • DVD Video: UDF bridge • DivX/MPEG1/MPEG2/JPEG/MP3/WMA/WAV/AAC: ISO 9660 level 1, level 2, Romeo, Joliet | <ul style="list-style-type: none"> • DVD Video • DivX/MPEG1/ MPEG2 • JPEG • MP3/WMA/ WAV/AAC |
| Dual Disc | DVD side |
| CD/VCD | <ul style="list-style-type: none"> • VCD (Video CD) • Audio CD/ CD Text (CD-DA) |
| CD Recordable/Rewritable (CD-R/-RW) <ul style="list-style-type: none"> • ISO 9660 level 1, level 2, Romeo, Joliet | <ul style="list-style-type: none"> • VCD (Video CD) • CD-DA • DivX/MPEG1/ MPEG2 • JPEG • MP3/WMA/ WAV/AAC |

*¹ DVD Region code:

For DDX4025DAB/DDX4025BT/DDX3025: 2

For DDX4055BT/DDX3055/DDX355: 5

If you insert a DVD Video disc of an incorrect Region Code, "Region Code Error" appears on the screen.

*² DVD-R recorded in multi-border format is also playable (except for dual layer discs). DVD-RW dual layer discs are not playable.

*³ It is possible to play back finalized +R/+RW (Video format only) discs. "DVD" is selected as the disc type when a +R/+RW disc is loaded. +RW double layer discs are not playable.

Unplayable discs

- Unplayable disc types and formats are as follows:
 - DVD-Audio/DVD-ROM discs
 - MPEG4/DVD-VR/DVD+VR/DVD-RAM recorded in the DVD-R/RW or +R/+RW
 - DTS-CD, SVCD (Super Video CD), CD-ROM, CD-I (CD-I Ready)
 - MPEG4 recorded in the CD-R/RW
- Discs that are not round.
- Discs with coloring on the recording surface or discs that are dirty.
- Recordable/Rewritable discs that have not been finalized.
- 8 cm disc. Attempting to insert using an adapter may cause malfunction.

DualDisc playback

The Non-DVD side of a "DualDisc" does not comply with the "Compact Disc Digital Audio" standard. Therefore, the use of Non-DVD side of a DualDisc on this product cannot be recommended.

REFERENCES

Playing Recordable/Rewritable discs

- This unit can recognize a total of 5 000 files and 250 folders (a maximum of 999 files per folder).
- Use only “finalized” discs.
- This unit can play back multi-session discs; however, unclosed sessions will be skipped while playing.
- Some discs or files may not be played back due to their characteristics or recording conditions.

❑ About data stored in the connected USB device/iPod/iPhone

- We bear no responsibility for any loss of data in an iPod/iPhone and USB mass storage class device while using this unit.

❑ USB playback

Playable files on a USB device

- This unit can play JPEG/DivX/MPEG1/MPEG2/MP3/WMA/WAV/AAC files stored in a USB mass storage class device.
- This unit can recognize a total of 5 000 files and 250 folders (a maximum of 999 files per folder).
- Make sure all important data has been backed up to avoid losing the data.

Notes on using a USB device:

- This unit may not play back files in a USB device properly when using a USB extension cable.
- USB devices equipped with special functions such as data security functions cannot be used with the unit.
- Do not use a USB device with 2 or more partitions.

- Depending on the shape of the USB devices and connection ports, some USB devices may not be attached properly or the connection might be loose.
- This unit may not recognize a memory card inserted into the USB card reader.
- When connecting with a USB cable, use the USB 2.0 cable.
- The maximum number of characters (when the characters are 1 byte):
 - Folder names: 50 characters
 - File names: 50 characters
- Avoid using the USB device if it might affect driving safety.
- Do not pull out and connect the USB device repeatedly while “Reading...” is shown on the screen.
- Electrostatic shock at connecting a USB device may cause abnormal playback of the device. In this case, disconnect the USB device then reset this unit and the USB device.
- Operation and power supply may not work as intended for some USB devices.
- Do not leave a USB device in the car, or expose to direct sunlight or high temperature to avoid deformation or damage to the device.

❑ Notes on playing iPod/iPhone

- iPod/iPhone that can be connected to this unit:
 - Made for
 - iPod with video
 - iPod classic
 - iPod nano (7th Generation)*

- iPod nano (6th Generation)
- iPod nano (5th Generation)
- iPod nano (4th Generation)
- iPod nano (3rd Generation)
- iPod touch (5th Generation)*
- iPod touch (4th Generation)
- iPod touch (3rd Generation)
- iPod touch (2nd Generation)
- iPod touch (1st Generation)
- iPhone 5*
- iPhone 4S
- iPhone 4
- iPhone 3GS
- iPhone 3G
- iPhone

* You cannot watch video when connecting iPod nano (7th Generation)/iPod touch (5th Generation)/iPhone 5.

- When operating an iPod/iPhone, some operations may not be performed correctly or as intended. In this case, visit the following KENWOOD web site: <www.kenwood.com/cs/ce/ipod>
- For some iPod/iPhone models, the performance may be abnormal or unstable during operation. In this case, disconnect the iPod/iPhone device, then check its condition. If the performance is not improved or slow, reset your iPod/iPhone.
- When you turn on this unit, the iPod/iPhone is charged through the unit.
- The text information may not be displayed correctly.

REFERENCES

Language codes (for DVD language selection)

| | | | | | | | |
|----|-----------------|----|------------------|----|----------------|----|------------|
| AA | Afar | GL | Galician | MI | Maori | SO | Somali |
| AB | Abkhazian | GN | Guarani | MK | Macedonian | SQ | Albanian |
| AF | Afrikaans | GU | Gujarati | ML | Malayalam | SR | Serbian |
| AM | Ameharic | HA | Hausa | MN | Mongolian | SS | Siswati |
| AR | Arabic | HI | Hindi | MO | Moldavian | ST | Sesotho |
| AS | Assamese | HR | Croatian | MR | Marathi | SU | Sundanese |
| AY | Aymara | HU | Hungarian | MS | Malay (MAY) | SW | Swahili |
| AZ | Azerbaijani | HY | Armenian | MT | Maltese | TA | Tamil |
| BA | Bashkir | IA | Interlingua | MY | Burmese | TE | Telugu |
| BE | Byelorussian | IE | Interlingue | NA | Nauru | TG | Tajik |
| BG | Bulgarian | IK | Inupiak | NE | Nepali | TH | Thai |
| BH | Bihari | IN | Indonesian | NO | Norwegian | TI | Tigrinya |
| BI | Bislama | IS | Icelandic | OC | Occitan | TK | Turkmen |
| BN | Bengali, Bangla | IW | Hebrew | OM | (Afan) Oromo | TL | Tagalog |
| BO | Tibetan | JA | Japanese | OR | Oriya | TN | Setswana |
| BR | Breton | JI | Yiddish | PA | Panjabi | TO | Tonga |
| CA | Catalan | JW | Javanese | PL | Polish | TR | Turkish |
| CO | Corsican | KA | Georgian | PS | Pashto, Pushto | TS | Tsonga |
| CS | Czech | KK | Kazakh | QU | Quechua | TT | Tatar |
| CY | Welsh | KL | Greenlandic | RM | Rhaeto-Romance | TW | Twi |
| DZ | Bhutani | KM | Cambodian | RN | Kirundi | UK | Ukrainian |
| EL | Greek | KN | Kannada | RO | Rumanian | UR | Urdu |
| EO | Esperanto | KO | Korean (KOR) | RW | Kinyarwanda | UZ | Uzbek |
| ET | Estonian | KS | Kashmiri | SA | Sanskrit | VI | Vietnamese |
| EU | Basque | KU | Kurdish | SD | Sindhi | VO | Volapuk |
| FA | Persian | KY | Kirghiz | SG | Sangho | WO | Wolof |
| FI | Finnish | LA | Latin | SH | Serbo-Croatian | XH | Xhosa |
| FJ | Fiji | LN | Lingala | SI | Singhalese | YO | Yoruba |
| FO | Faroese | LO | Laothian | SK | Slovak | ZU | Zulu |
| FY | Frisian | LT | Lithuanian | SL | Slovenian | | |
| GA | Irish | LV | Latvian, Lettish | SM | Samoan | | |
| GD | Scots Gaelic | MG | Malagasy | SN | Shona | | |

REFERENCES

Error message list

If an error occurs while using the unit, a message appears. Take appropriate action according to the following message/remedy/cause list.

“No Signal”:

- Start the playback on the external component connected to the AV-IN1 or iPod/AV-IN2 input terminal.
- Check the cords and connections.
- Signal input is too weak.

“Miswiring DC Offset Error”/“Warning DC Offset Error”:

- A speaker cord has shorted or it has come in to contact with the car chassis. Wire or insulate the speaker cord as appropriate, then reset the unit. (Pages 3 and 51)

“Parking off”:

- No playback picture is shown when the parking brake is not engaged.

“Authorization Error”:

- Check whether the connected iPod/iPhone is compatible with this unit. (Page 56)

“USB Device Error”:

- The USB power voltage is abnormal.
- Turn off and turn on the unit.
- Connect another USB device.

“No Navigation”:

- No navigation unit is connected.

“Connection Error”:

- The device is registered but the connection has failed. Connect the registered device. (Page 30)

“Please Wait...”:

- The unit is preparing to use the Bluetooth function. If the message does not disappear, turn off and turn on the unit, then connect the device again (or reset the unit).

“No Voice Device”:

- The connected mobile phone does not have a voice recognition system.

“No Data”:

- No phone book data is contained in the connected Bluetooth phone.

“Initialize Error”:

- The unit has failed to initialize the Bluetooth module. Try the operation again.

“Dial Error”:

- Dialing has failed. Try the operation again.

“Hung Up Error”:

- The call has not ended yet. Park your car, and use the connected mobile phone to end the call.

“Pick Up Error”:

- The unit has failed to receive a call.

“Antenna Error”:

- The antenna has a short-circuit and the protective circuit has activated.
- Check the Digital Radio antenna. If a passive antenna without a booster is used, set Antenna power “OFF”.

REFERENCES

Troubleshooting

What appears to be trouble is not always serious. Check the following points before calling a service center.

- For operations with the external components, refer also to the instructions supplied with the adapters used for the connections (as well as the instructions supplied with the external components).

❑ General

No sound comes out of the speakers.

- Adjust the volume to the optimum level.
- Check the cords and connections.

No picture is displayed on the screen.

- Turn on the screen. (Page 8)

The unit does not work at all.

- Reset the unit. (Page 3)

The remote controller* does not work.

- Replace the battery.

* Purchase KNA-RCDV331 separately.

❑ Discs in general

Recordable/Rewritable discs cannot be played back.

- Insert a finalized disc.
- Finalize the discs with the component which you used for recording.

Tracks on the Recordable/Rewritable discs cannot be skipped.

- Insert a finalized disc.
- Finalize the discs with the component which you used for recording.

Playback does not start.

- The format of files is not supported by the unit.

No picture appears on the external monitor.

- Connect the video cord correctly.
- Select the correct input on the external monitor.

❑ DivX/MPEG1/MPEG2/JPEG/MP3/WMA/WAV/AAC

Disc cannot be played back.

- Record the tracks using a compliant application on the appropriate discs. (Page 55)
- Add appropriate extension codes to the file names.

Tracks are not played back as you have intended them to play.

- Playback order may differ from the one played back using other players.

REFERENCES

❑ USB

“Reading...” does not disappear from the screen.

- Turn the power off and on again.

While playing a track, sound is sometimes interrupted.

- The tracks are not properly copied into the USB device. Copy tracks again, and try again.

❑ iPod/iPhone

No sound comes out of the speakers.

- Disconnect the iPod/iPhone, then connect it again.
- Select another source, then reselect “iPod”.

The iPod/iPhone does not turn on or does not work.

- Check the connecting cable and its connection.
- Update the firmware version.
- Charge the battery.
- Reset the iPod/iPhone.

Sound is distorted.

- Deactivate the equalizer either on this unit or the iPod/iPhone.

A lot of noise is generated.

- Turn off (uncheck) “VoiceOver” of the iPod/iPhone. For details, visit <<http://www.apple.com>>.

No operations are available when playing back a track containing Artwork.

- Operate the unit after the Artwork is loaded.

Sound does not synchronize with the video.

- Select [iPod] for <AV Input>. (Page 43)

Videos cannot be played.

- Connect with USB Audio and Video cable KCA-iP22F/KCA-iP202. Other cables cannot be used.
- Select [iPod] for <AV Input>. (Page 43)

No sound of videos comes out.

- Connect with USB Audio and Video cable KCA-iP22F/KCA-iP202. Other cables cannot be used.
- Select [iPod] for <AV Input>. (Page 43)

❑ Tuner

AME automatic presetting does not work.

- Store stations manually. (Page 20)

Static noise while listening to the radio.

- Connect the aerial firmly.

❑ Digital Radio (DAB)

Cannot receive an ensemble.

- Your area is not covered by the ensemble.

The DAB aerial is not properly extended or positioned.

- Adjust the aerial and try the ensemble scanning again.
- Connect an active antenna (not supplied).

❑ AV-IN1/AV-IN2

No picture appears on the screen.

- Turn on the video component if it is not on.
- Connect the video component correctly.
- When “AV-IN2” is selected as the source, set <AV Input> to [AV-IN].

REFERENCES

Bluetooth (Only for DDX4025DAB/ DDX4025BT/DDX4055BT)

Phone sound quality is poor.

- Reduce the distance between the unit and the Bluetooth mobile phone.
- Move the car to a place where you can get a better signal reception.

The sound is interrupted or skipped while using a Bluetooth audio player.

- Reduce the distance between the unit and the Bluetooth audio player.
- Disconnect the device connected for Bluetooth phone.
- Turn off, then turn on the unit.
- (When the sound is not yet restored) connect the player again.

The connected audio player cannot be controlled.

- Check whether the connected audio player supports AVRCP (Audio Video Remote Control Profile).

Bluetooth device does not detect the unit.

- Search from the Bluetooth device again.

The unit does not make pairing with the Bluetooth device.

- For devices compatible with Bluetooth 2.1: Register the device using a PIN code. (Page 29)
- For devices compatible with Bluetooth 2.0: Enter the same PIN code for both the unit and target device. If the PIN code of the device is not indicated on its instructions, try "0000" or "1234."

Echo or noise occurs.

- Adjust the microphone unit position.

The unit does not respond when you try to copy the phone book to the unit.

- You may have tried to copy the same entries (as stored) to the unit.

Specifications

Monitor section

| | |
|----------------------|--|
| Picture Size (W x H) | 6.1 inches (diagonal) wide 136.2 mm x 72 mm |
| Display System | Transparent TN LCD panel |
| Drive System | TFT active matrix system |
| Number of Pixels | 1 152 000 (800H x 480V x RGB) |
| Effective Pixels | 99.99% |
| Pixel Arrangement | RGB striped arrangement |
| Back Lighting | LED |

DVD player section

| | |
|--|--|
| D/A Converter | 24 bit |
| Audio Decoder | Linear PCM/Dolby Digital/MP3/WMA/AAC/WAV |
| Video Decoder | MPEG1/MPEG2/DivX |
| Wow & Flutter | Below Measurable Limit |
| Frequency Response | 96 kHz Sampling: 20 Hz – 22 000 Hz 48 kHz Sampling: 20 Hz – 22 000 Hz 44.1 kHz Sampling: 20 Hz – 20 000 Hz |
| Total Harmonic Distortion | 0.010% (1 kHz) |
| Signal to Noise Ratio | 99 dB (DVD-Video 96 kHz) |
| Dynamic Range | 99 dB (DVD-Video 96 kHz) |
| Disc Format | DVD-Video/DVD-VR/VIDEO-CD/CD-DA |
| Sampling Frequency | 44.1 kHz/48 kHz/96 kHz |
| Quantifying Bit Number | 16/20/24 bit |
| <input type="checkbox"/> USB interface section | |
| USB Standard | USB 2.0 Full Speed |
| File System | FAT 16/32 |
| Maximum Power Supply Current | DC 5 V $\overline{\text{---}}$ 1 A |
| D/A Converter | 24 bit |
| Video Decoder | MPEG1/MPEG2/DivX |
| Audio Decoder | MP3/WMA/AAC/WAV |

REFERENCES

❑ Bluetooth section (DDX4025DAB/ DDX4025BT/DDX4055BT)

| | |
|-----------------------------|--|
| Technology | Bluetooth 2.1 + EDR |
| Frequency | 2.402 GHz – 2.480 GHz |
| Output Power | +4 dBm (MAX), 0 dBm (AVE), Power Class 2 |
| Maximum Communication Range | Line of sight approx. 10 m |
| Audio Codec | SBC |
| Profile | HFP (Hands Free Profile) OPP (Object Push Profile) PBAP (Phonebook Access Profile) A2DP (Advanced Audio Distribution Profile) AVRCP (Audio/Video Remote Control Profile) GAP (Generic Access Profile) SDP (Service Discovery Profile) SPP (Serial Port Profile) |

❑ Digital tuner (DAB) section (DDX4025DAB)

| | |
|-----------------------|---|
| Frequency Range | L-BAND: 1 452.960 MHz – 1 490.624 MHz BAND III: 174.928 MHz – 239.200 MHz |
| Sensitivity | –100 dBm |
| Signal to Noise Ratio | 90 dB |
| DAB Antenna Connector | Connector type: SMB Output Voltage: 14.4 V (11 V – 16 V allowable) Maximum Current: <100 mA |

❑ FM tuner section

| | |
|--|--|
| Frequency Range (50 kHz) | 87.5 MHz to 108.0 MHz |
| Usable Sensitivity (S/N: 30 dB Dev 22.5 kHz) | 9.3 dBf (0.8 μ V/75 Ω)/0.7 μ V/75 Ω |
| Quieting Sensitivity (S/N: 46 dB Dev 22.5 kHz) | 15.2 dBf (1.6 μ V/75 Ω) |
| Frequency Response (\pm 3.0 dB) | 30 Hz – 15 kHz |
| Signal to Noise Ratio | 75 dB (MONO) |
| Selectivity (\pm 400 kHz) | \geq 80 dB |
| Stereo Separation | 45 dB (1 kHz) |

❑ LW tuner section

| | |
|-------------------------|-------------------|
| Frequency Range (9 kHz) | 153 kHz – 279 kHz |
| Usable Sensitivity | 45 μ V |

❑ MW tuner section

| | |
|-------------------------|---------------------|
| Frequency Range (9 kHz) | 531 kHz – 1 611 kHz |
| Usable Sensitivity | 25 μ V |

❑ Video section

| | |
|--|----------------------|
| Color System of External Video Input | NTSC/PAL |
| External Video Input Level (mini jack) | 1 Vp-p/75 Ω |
| External Audio Max Input Level (mini jack) | 2 V/25 k Ω |
| Video Output Level (RCA jack) | 1 Vp-p/75 Ω |
| Audio Output Level (mini jack) | 1.2 V/10 k Ω |
| Analog RGB input | 0.7 Vp-p/75 Ω |

❑ Audio section

| | |
|--|--|
| Maximum Power (Front & Rear) | 50 W \times 4 |
| Full Bandwidth Power (Front & Rear) (PWR DIN45324, +B=14.4 V) | 30 W \times 4 |
| Preout Level | 4 V/10 k Ω |
| Preout Impedance | \leq 600 Ω |
| Speaker Impedance | 4 Ω – 8 Ω |
| Tone | Bass: 100 Hz \pm 8 dB Middle: 1 kHz \pm 8 dB Treble: 12.5 kHz \pm 8 dB |

REFERENCES

□ General

| | |
|-------------------------------------|----------------------------------|
| Operating Voltage | 14.4 V (10.5 V – 16 V allowable) |
| Maximum Current Consumption | 10 A |
| Installation Dimensions (W × H × D) | 182 mm × 111 mm × 162 mm |
| Operational Temperature Range | -10°C – +60°C |
| Weight | 2.0 kg |

Design and specifications are subject to change without notice.

□ Trademarks and licenses

- Manufactured under license from Dolby Laboratories. Dolby and the double-D symbol are trademarks of Dolby Laboratories.
- “DVD Logo” is a trademark of DVD Format/Logo Licensing Corporation registered in the US, Japan and other countries.
- The “AAC” logo is a trademark of Dolby Laboratories.
- Microsoft and Windows Media are either registered trademarks or trademarks of Microsoft Corporation in the United States and/or other countries.
- “Made for iPod,” and “Made for iPhone” mean that an electronic accessory has been designed to connect specifically to iPod, or iPhone, respectively, and has been certified by the developer to meet Apple performance standards. Apple is not responsible for the operation of this device or its compliance with safety and regulatory standards. Please note that the use of this accessory with iPod, or iPhone may affect wireless performance. iPhone, iPod, iPod classic, iPod nano, and iPod touch are trademarks of Apple Inc., registered in the U.S. and other countries.
- Lightning is a trademark of Apple Inc.
- This item incorporates copy protection technology that is protected by U.S. patents and other intellectual property rights of Rovi Corporation. Reverse engineering and disassembly are prohibited.
- Font for this product is designed by Ricoh.
- DivX®, DivX Certified® and associated logos are trademarks of Rovi Corporation or its subsidiaries and are used under license.
- ABOUT DIVX VIDEO: DivX® is a digital video

format created by DivX, LLC, a subsidiary of Rovi Corporation. This is an official DivX Certified® device that plays DivX video. Visit divx.com for more information and software tools to convert your files into DivX videos.

- ABOUT DIVX VIDEO-ON-DEMAND: This DivX Certified® device must be registered in order to play purchased DivX Video-on-Demand (VOD) movies. To obtain your registration code, locate the DivX VOD section in your device setup menu. Go to vod.divx.com for more information on how to complete your registration.
- THIS PRODUCT IS LICENSED UNDER THE MPEG-4 VISUAL PATENT PORTFOLIO LICENSE FOR THE PERSONAL AND NON-COMMERCIAL USE OF A CONSUMER FOR (i) ENCODING VIDEO IN COMPLIANCE WITH THE MPEG-4 VISUAL STANDARD (“MPEG-4 VIDEO”) AND/OR (ii) DECODING MPEG-4 VIDEO THAT WAS ENCODED BY A CONSUMER ENGAGED IN A PERSONAL AND NON-COMMERCIAL ACTIVITY AND/OR WAS OBTAINED FROM A VIDEO PROVIDER LICENSED BY MPEG LA TO PROVIDE MPEG-4 VIDEO. NO LICENSE IS GRANTED OR SHALL BE IMPLIED FOR ANY OTHER USE. ADDITIONAL INFORMATION INCLUDING THAT RELATING TO PROMOTIONAL, INTERNAL AND COMMERCIAL USES AND LICENSING MAY BE OBTAINED FROM MPEG LA, LLC. SEE [HTTP://WWW.MPEGLA.COM](http://WWW.MPEGLA.COM).
- The Bluetooth® word mark and logos are registered trademarks owned by Bluetooth SIG, Inc. and any use of such marks by JVC KENWOOD Corporation is under license. Other trademarks and trade names are those of their respective owners.

For DDX4025DAB/DDX4025BT/DDX4055BT



Declaration of Conformity with regard to the EMC Directive 2004/108/EC
Declaration of Conformity with regard to the R&TTE Directive 1999/5/EC
Declaration of Conformity with regard to the RoHS Directive 2011/65/EU

Manufacturer:

JVC KENWOOD Corporation
3-12 Moriya-cho, Kanagawa-ku, Yokohama-shi, Kanagawa, 221-0022, Japan

EU Representative:

JVCKENWOOD NEDERLAND B.V.
Amsterdamseweg 37, 1422 AC UITHOORN, The Netherlands

English

Hereby, JVC KENWOOD declares that this unit "DDX4025DAB/DDX4025BT/DDX4055BT" is in compliance with the essential requirements and other relevant provisions of Directive 1999/5/EC.

Français

Par la présente JVC KENWOOD déclare que l'appareil "DDX4025DAB/DDX4025BT/DDX4055BT" est conforme aux exigences essentielles et aux autres dispositions pertinentes de la directive 1999/5/EC.
Par la présente, JVC KENWOOD déclare que ce "DDX4025DAB/DDX4025BT/DDX4055BT" est conforme aux exigences essentielles et aux autres dispositions de la directive 1999/5/EC qui lui sont applicables.

Deutsch

Hiermit erklärt JVC KENWOOD, dass sich dieser "DDX4025DAB/DDX4025BT/DDX4055BT" in Übereinstimmung mit den grundlegenden Anforderungen und den anderen relevanten Vorschriften der Richtlinie 1999/5/EC befindet. (BMW)
Hiermit erklärt JVC KENWOOD die Übereinstimmung des Gerätes "DDX4025DAB/DDX4025BT/DDX4055BT" mit den grundlegenden Anforderungen und den anderen relevanten Festlegungen der Richtlinie 1999/5/EC. (Wien)

Nederlands

Hierbij verklaart JVC KENWOOD dat het toestel "DDX4025DAB/DDX4025BT/DDX4055BT" in overeenstemming is met de essentiële eisen en de andere relevante bepalingen van richtlijn 1999/5/EC. Bij deze verklaart JVC KENWOOD dat deze "DDX4025DAB/DDX4025BT/DDX4055BT" voldoet aan de essentiële eisen en aan de overige relevante bepalingen van Richtlijn 1999/5/EC.

Italiano

Con la presente JVC KENWOOD dichiara che questo "DDX4025DAB/DDX4025BT/DDX4055BT" è conforme ai requisiti essenziali ed alle altre disposizioni pertinenti stabilite dalla direttiva 1999/5/EC.

Español

Por medio de la presente JVC KENWOOD declara que el "DDX4025DAB/DDX4025BT/DDX4055BT" cumple con los requisitos esenciales y cualesquiera otras disposiciones aplicables o exigibles de la Directiva 1999/5/EC.

Português

JVC KENWOOD declara que este "DDX4025DAB/DDX4025BT/DDX4055BT" está conforme com os requisitos essenciais e outras disposições da Directiva 1999/5/EC.

Polska

JVC KENWOOD niniejszym oświadcza, że "DDX4025DAB/DDX4025BT/DDX4055BT" spełnia zasadnicze wymogi oraz inne istotne postanowienia dyrektywy 1999/5/EC.

Český

JVC KENWOOD tímto prohlašuje, že tento "DDX4025DAB/DDX4025BT/DDX4055BT" je ve shodě se základními požadavky a dalšími příslušnými ustanoveními směrnice 1999/5/EC.

Magyar

Alulírott, JVC KENWOOD, kijelenti, hogy a jelen "DDX4025DAB/DDX4025BT/DDX4055BT" megfelel az 1999/5/EC irányelvben meghatározott alapvető követelményeknek és egyéb vonatkozó előírásoknak.

Svenska

Härmed intygar JVC KENWOOD att denna "DDX4025DAB/DDX4025BT/DDX4055BT" står i överensstämmelse med de väsentliga egenskapskrav och övriga relevanta bestämmelser som framgår av direktiv 1999/5/EC.

Suomi

JVC KENWOOD vakuuttaa täten että "DDX4025DAB/DDX4025BT/DDX4055BT" tyypinen laite on direktiivin 1999/5/EC oleellisten vaatimusten ja sitä koskevien direktiivin muiden ehtojen mukainen.

Slovensko

S tem JVC KENWOOD izjavlja, da je ta "DDX4025DAB/DDX4025BT/DDX4055BT" v skladu z osnovnimi zahtevami in ostalimi ustreznimi predpisi Direktive 1999/5/EC.

Slovensky

Spoločnosť JVC KENWOOD týmto vyhlasuje, že "DDX4025DAB/DDX4025BT/DDX4055BT" spĺňa základné požiadavky a ďalšie príslušné ustanovenia Direktívy 1999/5/EC.

Dansk

Undertegnede JVC KENWOOD erklærer herved, at følgende udstyr "DDX4025DAB/DDX4025BT/DDX4055BT" overholder de væsentlige krav og øvrige relevante krav i direktiv 1999/5/EC.

Ελληνικά

ΜΕ ΤΗΝ ΠΑΡΟΥΣΑ JVC KENWOOD ΔΗΛΩΝΕΙ ΟΤΙ "DDX4025DAB/DDX4025BT/DDX4055BT" ΣΥΜΜΟΡΦΩΝΕΤΑΙ ΠΡΟΣ ΤΙΣ ΟΥΣΙΩΔΕΙΣ ΑΠΑΙΤΗΣΕΙΣ ΚΑΙ ΤΙΣ ΛΟΙΠΕΣ ΣΧΕΤΙΚΕΣ ΔΙΑΤΑΞΕΙΣ ΤΗΣ ΟΔΗΓΙΑΣ 1999/5/EC.

Eesti

Sellega kinnitab JVC KENWOOD, et see "DDX4025DAB/DDX4025BT/DDX4055BT" vastab direktiivi 1999/5/EC põhilistele nõudmistele ja muudele asjakohastele määrustele.

Latviešu

Ar šo, JVC KENWOOD, apstiprina, ka "DDX4025DAB/DDX4025BT/DDX4055BT" atbilst Direktīvas 1999/5/EC galvenajām prasībām un citiem tās nosacījumiem.

Lietuviškai

Šiuo, JVC KENWOOD, pareiškia, kad šis "DDX4025DAB/DDX4025BT/DDX4055BT" atitinka pagrindinius Direktyvos 1999/5/EC reikalavimus ir kitas svarbias nuostatas.

Malti

Hawnhekk, JVC KENWOOD, jiddikjara li dan "DDX4025DAB/DDX4025BT/DDX4055BT" jikkonforma mal-ħtiġijiet essenzjali u ma provvediment i oħrajn relevanti li hemm fid-Direttiva 1999/5/EC.

Українська

Компанія JVC KENWOOD заявляє, що цей виріб "DDX4025DAB/DDX4025BT/DDX4055BT" відповідає ключовим вимогам та іншим пов'язаним положенням Директиви 1999/5/EC.

Türkçe

Bu vesileyle JVC KENWOOD, "DDX4025DAB/DDX4025BT/DDX4055BT" ünitesinin, 1999/5/EC Direktifinin başlıca gereksinimleri ve diğer ilgili hükümleri ile uyumlu olduğunu beyan eder.

Hrvatski

Ovime JVC KENWOOD izjavljuje da je ova jedinica "DDX4025DAB/DDX4025BT/DDX4055BT" je u skladu s osnovnim zahtjevima i drugim relevantnim odredbama Direktive 1999/5/EC.

KENWOOD