

KENWOOD

INSTRUCTION MANUAL
MODE D'EMPLOI
MANUAL DE INSTRUCCIONES
MANUALE DI ISTRUZIONI
BEDIENUNGSANLEITUNG
GEBRUIKSAANWIJZING



ProTalk
TK-3201

UHF FM TRANSCEIVER
ÉMETTEUR-RÉCEPTEUR FM UHF
TRANSCÉPTOR DE FM UHF
RICETRASMETTITORE FM UHF
UHF-FM-TRANSCEIVER
UHF FM ZENDONTVANGER

KENWOOD CORPORATION

© B62-1807-20 (E, T)
09 08 07 06 05 04 03 02

ProTalk

TK-3201

UHF FM TRANSCEIVER

INSTRUCTION MANUAL

ENGLISH

THANK YOU

We are grateful for your purchase of this **KENWOOD** product and welcome you to the Private Mobile Radio service (PMR 446). PMR is a mobile communication system for both business and personal use without the need for a license and with no call charges.

Your **KENWOOD** 2-way Private Radio is called a “transceiver”, meaning “transmitter & receiver”. We believe this easy-to-use transceiver will provide you with dependable and reliable communications. This **KENWOOD** transceiver is a precision device. Treat it with care, and you will enjoy years of reliable operation.

FEATURES

- 16 channels with 8 operating frequencies and 38 tone/ code settings for each channel allows you to ignore unwanted calls.
- Built in voice scrambler gives you complete privacy for your conversations.
- Hands free operation when using an optional headset.
- Voice announcement lets you know which channel you have selected and which settings you have made when reassigning key functions and channel settings.

OPERATING CONDITIONS

Open locations (no obstructions)	Up to 6.4 km
Residential areas (near buildings)	Up to 2.4 km
In steel/ concrete reinforced buildings	Up to 18,580 m ²
In high rises	Up to 15 floors

Note: The listed ranges are based on field testing and may vary with your operating conditions and individual transceiver.

PRECAUTIONS

- Refer service to qualified technicians only. Do not modify or attempt to adjust this transceiver for any reason.
- Do not expose the transceiver to long periods of direct sunlight, nor place it close to heating appliances.
- Do not place the transceiver in excessively dusty, humid, or wet areas, nor on unstable surfaces.
- Avoid extremes in exposure to weather, heat, and cold. This transceiver can be used in mild weather conditions, but it is not waterproof.
- Turn OFF your transceiver while taking on fuel or while parked in gasoline service stations.
- Do not operate your transceiver or charge your battery pack in an explosive atmosphere (gases, dust, fumes, etc.).
- If an abnormal odor or smoke is detected coming from the transceiver, immediately switch OFF the power and remove the battery pack from the transceiver. Contact your **KENWOOD** dealer.

- | |
|---|
| <ul style="list-style-type: none">◆ Government law prohibits the operation of unlicensed radio transmitters within the territories under government control.◆ Illegal operation is punishable by fine and/or imprisonment. |
|---|

Safety: It is important that the operator is aware of, and understands, hazards common to the operation of any transceiver.

CONTENTS

UNPACKING AND CHECKING EQUIPMENT	1
SUPPLIED ACCESSORIES	1
ORIENTATION	3
PREPARATION	4
INSTALLING/ REMOVING THE BATTERY PACK	4
CHARGING THE Ni-MH BATTERY PACK	5
INSTALLING THE BELT CLIP	7
INSTALLING THE COVER OVER THE SPEAKER/ MICROPHONE JACKS	7
INSTALLING THE OPTIONAL SPEAKER/ MICROPHONE (OR HEADSET)	8
GETTING STARTED	9
VOICE OPERATED TRANSMISSION (VOX)	10
VOX GAIN	10
VOX OPERATION	12
KEY FUNCTIONS	13
CALL KEY	13
MONITOR KEY	13
BACKGROUND OPERATIONS	14
TIME-OUT TIMER (TOT)	14
LOW BATTERY WARNING	14
CHANNEL ANNUNCIATION	14
QUIET TALK (QT)/ DIGITAL QUIET TALK (DQT)	15
CHANNEL SETUP MODE	16
CHANNEL OPERATING FREQUENCIES	17
QUIET TALK (QT)/ DIGITAL QUIET TALK (DQT) SETTINGS	19
CHANNEL CONFIRMATION MODE	22
KEY ASSIGNMENT MODE	23
CALLING ALERT	25
KEY LOCK	26
MONITOR/ SQUELCH OFF	26
SCAN	27
SCRAMBLER	29
OPTIONAL ACCESSORIES	30
TROUBLESHOOTING GUIDE	31

UNPACKING AND CHECKING EQUIPMENT

Carefully unpack the transceiver. We recommend you identify the items listed in the following table before discarding the packing material. If any items are missing or have been damaged during shipment, file a claim with the carrier immediately.

SUPPLIED ACCESSORIES

Item		Part Number	Quantity
Battery charger		W08-0969-XX	1
AC adaptor	Market code E	W08-0971-XX	1
	Market code T	W08-0972-XX	1
Ni-MH battery pack (KNB-29N)		W09-1000-XX	1
Speaker/ microphone jack cover		B09-0680-XX	1
Speaker/ microphone locking bracket		J19-5472-XX	1
Belt clip		J29-0713-XX	1
Screw set		N99-2043-XX	1
Warranty card		— —	1
Instruction manual		B62-1807-XX	1

Note: A market code (E or T) can be found on the label attached to the package box.



Battery charger

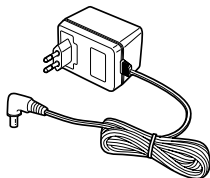

AC adaptor (E)

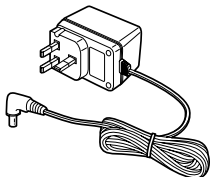

AC adaptor (T)

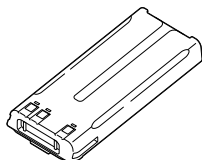

Ni-MH battery pack
(KNB-29N)



Speaker/ microphone
jack cover



Speaker/ microphone
locking bracket



Belt clip



Screw set

ORIENTATION

Antenna

LED indicator

Indicates the transceiver status. Lights red while transmitting, green while receiving, and flashes red while the battery power is low while transmitting.

Channel selector

Rotate to change the operating channel from 1 ~ 16.

**Power switch/
Volume control**

Turn clockwise to switch the power ON and counterclockwise to switch the power OFF. Rotate to adjust the volume.

PTT (Push to Talk) switch

Press and hold, then speak into the microphone to transmit.

Call key

Press before making a call, to alert the other party members {page 13}.

Monitor key

Press and hold to hear background noise and listen for weak signals {page 13}.

**Speaker/
microphone
jacks**

**Battery pack
(KNB-29N)**

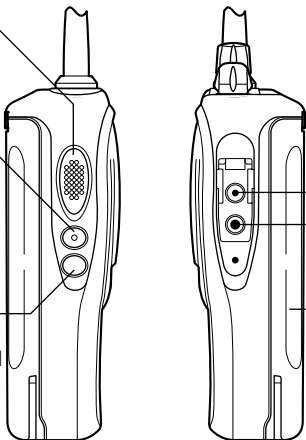
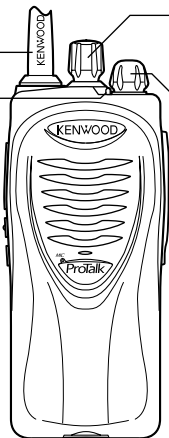

Note: The **Call** and **Monitor** keys can be reprogrammed {page 23}.

PREPARATION

INSTALLING/ REMOVING THE BATTERY PACK

The battery pack is not charged at the factory; charge it before use {pages 5 and 6}.

Average battery pack life (calculated using 5% transmit time, 5% receive time, and 90% standby time) is 16 hours.



CAUTION

- ◆ Do not short the battery terminals.
- ◆ Do not dispose of the battery by fire.
- ◆ Never attempt to remove the casing from the battery pack.

1

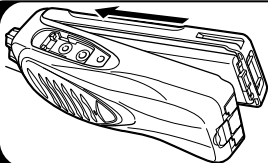

Align the battery pack with the back of the transceiver, then press the battery pack and transceiver firmly together until the release latch on the base of the transceiver locks.

2

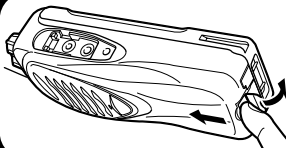

To remove the battery pack, lift the safety catch on the base of the transceiver, then press the release latch underneath the safety catch.

3

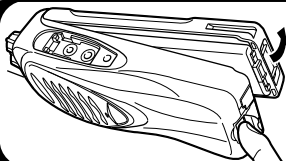

While pressing the release latch, pull the battery pack away from the transceiver.

CHARGING THE Ni-MH BATTERY PACK

The initial charging of the battery pack after purchase or extended storage (greater than 2 months) will not bring the battery pack to its normal operating capacity. After repeating the charge/ discharge cycle 2 or 3 times, the operating capacity will increase to normal.



CAUTION

- ◆ Do not recharge the battery pack if it is already fully charged. Doing so may cause the life of the battery pack to shorten or the battery pack may be damaged.
- ◆ After charging the battery pack, disconnect it from the charger. Charging the battery pack for more than 5 days may reduce the battery pack life due to overcharging.

Note:

- ◆ The ambient temperature should be between 5°C and 40°C while charging is in progress. Charging outside this range may not fully charge the battery.
 - ◆ Always switch OFF the transceiver equipped with a Ni-MH battery pack before charging. Using the transceiver while charging its battery pack will interfere with correct charging.
 - ◆ The battery pack life is over when its operating time decreases even though it is fully and correctly charged. Replace the battery pack.
-

1

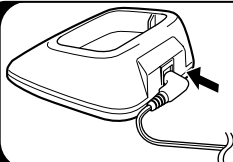

Plug the AC adaptor cable into the adaptor jack located at the rear of the charger.

2

Plug the AC adaptor into an AC outlet.

3

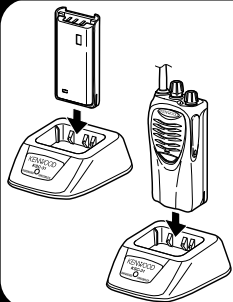

Slide the Ni-MH battery pack or transceiver with a Ni-MH battery pack into the charger.

- Make sure the battery pack terminals are in contact with the charger terminals by aligning the grooves of the battery pack with the tabs of the charger.
- The charger LED lights red and charging begins.

4

When charging is completed, the indicator lights green. Remove the battery pack or the transceiver with a battery pack from the charger.

- It takes approximately 3 hours to charge the battery pack.
- When the charger will not be used for a long time, unplug the AC adaptor from the AC outlet.

INSTALLING THE BELT CLIP

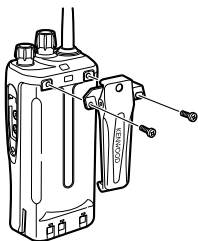

If necessary, attach the belt clip using the two supplied 3 x 8 mm screws.

Note: If the belt clip is not installed, its mounting location may get hot during continuous transmission or when left sitting in a hot environment.



CAUTION

Do not use glue which is designed to prevent screw loosening when installing the belt clip, as it may cause damage to the transceiver. Acrylic ester, which is contained in these glues, may crack the transceiver's back panel.

INSTALLING THE COVER OVER THE SPEAKER/ MICROPHONE JACKS

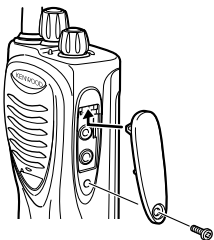

If you are not using a speaker/ microphone, install the cover over the speaker/ microphone jacks using the supplied 3 x 6 mm screw.

Note: To keep the transceiver water resistant, you must cover the speaker/ microphone jacks with the supplied cover.

INSTALLING THE OPTIONAL SPEAKER/ MICROPHONE (OR HEADSET)

1

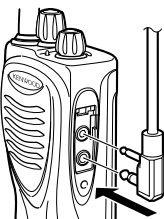

Insert the speaker/ microphone (or headset) plugs into the speaker/ microphone jacks.

Note: Always switch OFF the transceiver power when installing or removing a speaker/ microphone or headset.

2

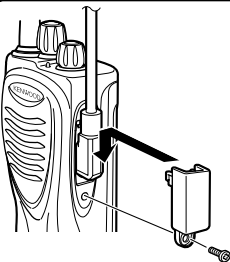

Attach the locking bracket using the supplied 3 x 6 mm screw.

Note: The transceiver is not fully water resistant while using the speaker/ microphone.

GETTING STARTED

1

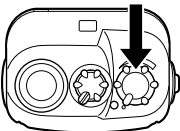

Turn the **Power** switch/ **Volume** control clockwise to switch the transceiver power ON.

- A beep sounds.

2



Press and hold the **Monitor** key to hear background noise, then rotate the **Power** switch/ **Volume** control to adjust the volume.

3

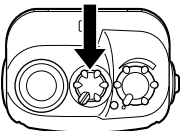

Rotate the **Channel** selector to select your desired channel.

- When you receive an appropriate signal, you will hear audio from the speaker.

4

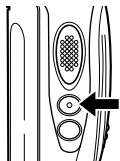

To make a call, press and hold the **PTT** switch, then press the **Call** key to alert the other party members that you are making a call. Release the **Call** key to stop sending your alert tone.

5

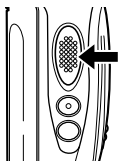

Continue pressing the **PTT** switch, then speak into the microphone to transmit. Release the **PTT** switch to receive.

- The LED lights red while transmitting.
- For best sound quality, speak into the microphone in your normal voice while holding the microphone approximately 3 to 4 cm from your lips.

VOICE OPERATED TRANSMISSION (VOX)

Using the VOX feature, you can operate the transceiver hands-free. In order to use this feature, however, you must use an optional headset; VOX will not function with the built-in microphone. For best operating conditions, we recommend you use an optional headset with both an ear piece and a microphone on a boom that rests in front of your mouth.

With VOX activated, your voice level will determine when the transceiver transmits. Because of this, you must take care that the ambient noise around you is not so loud that it causes the transceiver to transmit. Due to the automatic switching between transmission and reception, we recommend you set the VOX Gain level such that it will not activate transmission when in an area with excessive ambient noise.

VOX GAIN

To activate VOX and set the VOX Gain level:

1



With the transceiver power OFF, connect the headset to the transceiver {page 8}.

- The VOX function does not activate when a headset is not connected to the speaker/ microphone jack of the transceiver.

2

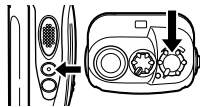

Press and hold the **Call** key while turning the transceiver power ON.

- Continue to hold the **Call** key until the LED lights orange and the transceiver announces "VOX", then release the key. Upon releasing the key, the transceiver will announce the current VOX Gain level.

3

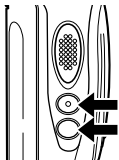

Press the **Call** key to increase the VOX Gain level and the **Monitor** key to decrease the level.

- The VOX Gain can be adjusted from level 1 to level 10 and OFF.
- The transceiver announces the VOX Gain level as you adjust it. If OFF is selected, the transceiver announces "Off".

4

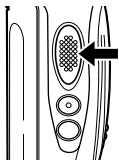

Press the **PTT** switch within 5 seconds to save the setting, otherwise the operation will cancel.

- A beep will sound and the transceiver will announce the new VOX Gain level.

5

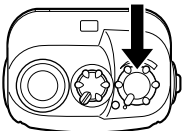

Turn the transceiver power OFF and then ON again to activate VOX.

Note:

- ◆ VOX Gain level 1 is the least sensitive and VOX Gain level 10 is the most sensitive.
 - ◆ If a speaker/ microphone is connected to the transceiver while the VOX function is switched ON and the VOX Gain level is configured to a higher, more sensitive level, louder received signals may cause the transceiver to start transmission.
 - ◆ The transceiver will automatically return to normal operation if no action is performed for 5 seconds.
-

VOX OPERATION

1 Set up a VOX Gain level from 1 to 10 {page 10}.

2 To transmit, simply speak into the headset microphone.

- You do not need to press the **PTT** switch; the transceiver automatically detects your voice and begins transmitting.

3 To stop transmitting, stop speaking.

- Transmission will continue momentarily after you stop speaking, so ensure your transmission will not be cut off.

4 To exit VOX mode, set the VOX Gain level {page 10} to OFF.

Note:

- ◆ While transmitting via VOX, all keys other than power OFF are disabled.
 - ◆ When you operate the VOX function, you must use an optional KHS-1 or KHS-21 accessory.
 - ◆ VOX will not operate when the battery level becomes too low. (The LED will flash red in this state.)
-

KEY FUNCTIONS

CALL KEY

The default function of the **Call** key is Calling Alert.

Calling alert tones are used to identify yourself to your party members and inform them that you are about to make a call. Your dealer can set up your transceiver with 1 of 10 different calling alert tones. If each party member uses a different calling alert tone, it is easy to know who is making the call.

To make a call using the calling alert tone, press and hold the **PTT** switch, then press the **Call** key.

- The calling alert tone will transmit for the duration you press the **Call** key.

MONITOR KEY

The default function of the **Monitor** key is Squelch Off Momentary.

When no signals are present, the squelch on the transceiver automatically mutes the speaker so you will not hear background noise. Using the Monitor key, you can disable the squelch to unmute the speaker at any time. This feature is useful for a variety of reasons:

- It allows you to confirm the channel activity so you don't make a call while another party is using the same channel.
- It allows you to adjust the volume level without having to wait for a call.
- When receiving a call that is intermittent due to a weak signal, disabling the squelch will allow you to listen to the call without it continuously cutting out.

To manually deactivate the squelch, press and hold the **Monitor** key.

To return to normal operation, simply release the **Monitor** key.

TIME-OUT TIMER (TOT)

The purpose of the Time-out Timer is to prevent you from using a channel for an extended period of time. This function is useful, for example, when you accidentally keep the **PTT** switch pressed. Additionally, by limiting the amount of time you can continuously transmit, this feature helps you save on battery power consumption.

If you continuously transmit for 60 seconds (default), the transceiver will stop transmitting and an alert tone will sound. To stop the tone, release the **PTT** switch. You can press the **PTT** switch again to resume transmitting.

LOW BATTERY WARNING

Low Battery Warning alerts you when the battery needs to be recharged or replaced.

While operating the transceiver, if the battery power becomes low, an alert tone will sound every 30 seconds and the LED indicator will blink red. Replace or recharge the battery pack at this time.

CHANNEL ANNUNCIATION

When changing the channel, the transceiver will announce the selected channel number after you stop changing the channel. Likewise, the transceiver will announce the current channel after you turn the transceiver power ON. (Channel Annunciation can be activated or deactivated by your dealer.)

QUIET TALK (QT)/ DIGITAL QUIET TALK (DQT)

Quiet Talk (QT) and Digital Quiet Talk (DQT) are functions that reject signals from undesired parties that are using the same channel as you. You will hear audio from the speaker only when you receive a signal that contains a QT tone or a DQT code that matches the one set up on the channel you are using. If a call containing a different tone or code is made on the same channel you are using, squelch will not open and you will not hear the call. Likewise, when you transmit on a channel set up with QT or DQT, the receiving station must have a matching tone or code in order to hear your call.

Although it may seem like you have your own private channel while using QT or DQT, other parties can still hear your calls if they set up their transceiver with the same tone or code.

The default QT/DQT settings for each channel are provided in the table on page 16.

CHANNEL SETUP MODE

This transceiver allows you to reprogram each of the channels with different frequencies and Quiet Talk/ Digital Quiet Talk settings. The table below lists the default channel settings.

Channel Number	Table Number	Frequency (MHz)	Tone Number	QT/DQT Setting
1	1	446.00625	10	94.8 Hz
2	8	446.09375	08	88.5 Hz
3	3	446.03125	13	103.5 Hz
4	6	446.06875	05	79.7 Hz
5	4	446.04375	17	118.8 Hz
6	2	446.01875	18	123.0 Hz
7	7	446.08125	19	127.3 Hz
8	5	446.05625	07	85.4 Hz
9	1	446.00625	14	107.2 Hz
10	8	446.09375	15	110.9 Hz
11	3	446.03125	16	114.8 Hz
12	6	446.06875	06	82.5 Hz
13	4	446.04375	27	D132N
14	2	446.01875	28	D155N
15	5	446.05625	29	D134N
16	7	446.08125	30	D243N

Note: If you do not select an operating frequency for a channel, you will not be able to select a Quiet Talk/ Digital Quiet Talk setting for that same channel.

CHANNEL OPERATING FREQUENCIES

To change the operating frequency of a channel:

1



With the transceiver power OFF, press and hold the **PTT** switch and **Call** key while turning the transceiver power ON.

- Continue to hold the **PTT** switch and **Call** key until the LED lights orange and the transceiver announces "Self".

2

Release the **PTT** switch and **Call** key.

- The transceiver announces "Channel".

3

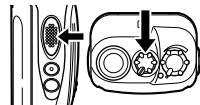

Press and release the **PTT** switch, then rotate the **Channel** selector to your desired channel.

- Upon pressing and releasing the PTT switch, a beep will sound and the transceiver announces "Table zero".

4

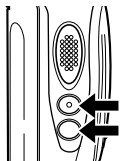

Press the **Call** key to increment the Table number or the **Monitor** key to decrement the number, to select the new channel frequency.

- Table numbers and their corresponding operating frequencies are provided in the table on page 18.
- A voice announcement will inform you of the currently selected Table number.

5

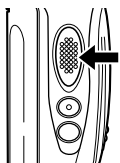

Press the **PTT** switch within 5 seconds to save the setting, otherwise the operation will cancel.

- A beep will sound.
- Repeat steps 3 to 5 to set up another channel.

6

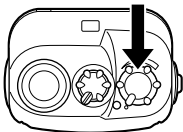

Turn the transceiver power **OFF** and then **ON** again to activate the new settings.

Note: The transceiver will automatically return to normal operation if no action is performed for 5 seconds.

Table Number	Operating Frequency	Table Number	Operating Frequency
0	--		
1	446.00625 MHz	5	446.05625 MHz
2	446.01875 MHz	6	446.06875 MHz
3	446.03125 MHz	7	446.08125 MHz
4	446.04375 MHz	8	446.09375 MHz

QUIET TALK (QT)/ DIGITAL QUIET TALK (DQT) SETTINGS

To change the QT/DQT settings of a channel:

1



With the transceiver power OFF, press and hold the **PTT** switch and **Call** key while turning the transceiver power ON.

- Continue to hold the **PTT** switch and **Call** key until the LED lights orange and the transceiver announces "Self".

2

Release the **PTT** switch and **Call** key.

- The transceiver announces "Channel".

3

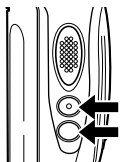

Press the **Call** key or **Monitor** key to select QT/DQT setup.

- The transceiver announces "Tone".

4



Press and release the **PTT** switch, then rotate the **Channel** selector to your desired channel.

- Upon pressing and releasing the PTT switch, a beep will sound and the transceiver announces "Tone one".

5

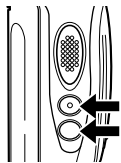

Press the **Call** key to increment the Tone number or the **Monitor** key to decrement the number, to select the new tone or code.

- Tone numbers and their corresponding tones/ codes are provided in the table on page 21.
- Press and hold the **Call** or **Monitor** key to increment/ decrement the Tone number by 5 at a time.
- A voice announcement will inform you of the currently selected Tone number.

6

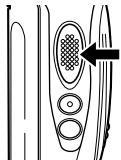

Press the **PTT** switch within 5 seconds to save the setting, otherwise the operation will cancel.

- A beep will sound.
- Repeat steps 4 to 6 to set up another channel.

7

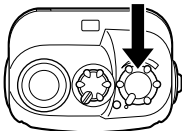

Turn the transceiver power **OFF** and then **ON** again to activate the new settings.

Note: The transceiver will automatically return to normal operation if no action is performed for 5 seconds.

Tone Number	QT/DQT Setting	Tone Number	QT/DQT Setting	Tone Number	QT/DQT Setting
1	67.0 Hz	14	107.2 Hz	27	D132N
2	71.9 Hz	15	110.9 Hz	28	D155N
3	74.4 Hz	16	114.8 Hz	29	D134N
4	77.0 Hz	17	118.8 Hz	30	D243N
5	79.7 Hz	18	123.0 Hz	31	D311N
6	82.5 Hz	19	127.3 Hz	32	D346N
7	85.4 Hz	20	131.8 Hz	33	D315N
8	88.5 Hz	21	136.5 Hz	34	D351N
9	91.5 Hz	22	141.3 Hz	35	D423N
10	94.8 Hz	23	146.2 Hz	36	D664N
11	97.4 Hz	24	151.4 Hz	37	D431N
12	100.0 Hz	25	156.7 Hz	38	D723N
13	103.5 Hz	26	162.2 Hz	Off	OFF

Note: The QT/DQT settings can be changed by your dealer.

CHANNEL CONFIRMATION MODE

To confirm your channel settings:

1



With the transceiver power OFF, press and hold the **PTT** switch while turning the transceiver power ON.

- Continue to hold the **PTT** switch until the LED lights orange and the transceiver announces “Channel Confirm”.

2

Release the **PTT** switch.

- The transceiver announces the channel Table number and Tone number of the current channel.

3

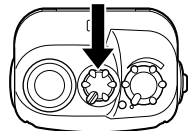

Rotate the **Channel** selector to your desired channel within 5 seconds, otherwise the operation will cancel.

- The transceiver announces the channel Table number and Tone number of the selected channel.

Note: The transceiver will automatically return to normal operation if no action is performed for 5 seconds.

KEY ASSIGNMENT MODE

This transceiver allows you to reprogram the **Call** and **Monitor** keys with any of the functions listed in the table below. Explanations on the use of each function are provided on the following pages.

Table Number	Function Name
0	None (no function)
1	Calling Alert (Call key default)
2	Key Lock
3	Key Lock with Backup
4	Monitor
5	Monitor Momentary
6	Scan
7	Scan + Temporary Delete
8	Scrambler
9	Squelch Off
10	Squelch Off Momentary (Monitor key default)
11	Temporary Delete

To change the functions of the **Call** and **Monitor** keys:

1



With the transceiver power OFF, press and hold the **Call** and **Monitor** keys while turning the transceiver power ON.

- Continue to hold the **Call** and **Monitor** keys until the LED lights orange and the transceiver announces "Setup".

2

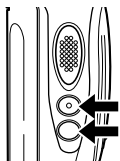

Continue to press and hold the key to be reprogrammed (either the **Call** key or the **Monitor** key), while releasing the remaining key.

- The transceiver will announce "Table zero" {page 23}.
- If you continue to hold both keys, or if you release both keys, the operation will cancel in 5 seconds.

3

Release the key.

4

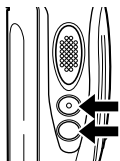

Press the **Call** key to increment the Table number or the **Monitor** key to decrement the number, to select the new key function

- Table numbers and their corresponding functions are provided in the table on page 23. □
- A voice announcement will inform you of the currently selected Table number.

5

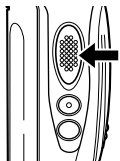

Press the **PTT** switch within 5 seconds to save the setting, otherwise the operation will cancel.

- A beep will sound and the transceiver will announce the new Table number.

6

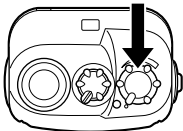

Turn the transceiver power **OFF** and then **ON** again to activate the new settings.

Note: The transceiver will automatically return to normal operation if no action is performed for 5 seconds.

CALLING ALERT

Calling alert tones are used to identify yourself to your party members and inform them that you are about to make a call. Your dealer can set up your transceiver with 1 of 10 different calling alert tones. If each party member uses a different calling alert tone, it is easy to know who is making the call.

To make a call using the calling alert tone, press and hold the **PTT** switch, then press the key programmed as **Calling Alert**.

- The calling alert tone will transmit for the duration you press the **Calling Alert** key.

KEY LOCK

Press and hold the key programmed as **Key Lock** for 1 second to lock/ unlock the transceiver keys. The following keys/ functions can still be used when Key Lock is active: Calling Alert, Key Lock, Monitor, Monitor Momentary, PTT, Squelch Off, Squelch Off Momentary, and Volume.

If the key is programmed “with Backup”, when the transceiver power is turned OFF and then ON again, the keys remain locked. Otherwise, when the transceiver power is turned OFF and then ON again, the Key Lock function will be cancelled.

MONITOR/ SQUELCH OFF

You can use the key programmed as **Monitor** or **Squelch Off** to listen to weak signals that you cannot hear during normal operation, to deactivate channel signalling, and to adjust the volume when no signals are present on your selected channel.

- **Monitor:** Momentarily press to deactivate Quiet Talk or Digital Quiet Talk signalling. Press the key again to return to normal operation.
- **Monitor Momentary:** Press and hold to deactivate Quiet Talk or Digital Quiet Talk signalling. Release the key to return to normal operation.
- **Squelch Off:** Momentarily press to hear background noise. Press the key again to return to normal operation.
- **Squelch Off Momentary:** Press and hold to hear background noise. Release the key to return to normal operation.

Note: The default Squelch level is set to 5 (out of 10). This value can be adjusted by your dealer.

SCAN

Scan is useful for monitoring signals on the transceiver channels. When scanning, the transceiver checks for a signal on each channel and only stops if a signal is present. If the QT/DQT matches, the transceiver stops at the channel and opens the squelch so you can listen to the call. If the QT/DQT does not match, the call is ignored and scanning continues.

Note: You can only use Scan if there are at least 2 channels available on your transceiver that are not locked out of Scan.

To start scanning, momentarily press the key programmed as either **Scan** or **Scan + Temporary Delete**.

- The LED indicator flashes green and scanning starts from the current channel and ascends through the channel numbers.
- When a signal is detected on a channel and the QT/DQT matches, scan pauses at that channel and the LED indicator lights green.
- When the signal is no longer present, scanning continues after 3 seconds (default).

To end Scan, press the **Scan** or **Scan + Temporary Delete** key again.

■ Priority Scan

The Priority channel is a channel that is given first priority to while scanning. The Priority channel is set by your dealer.

During Scan, the transceiver will automatically change to the Priority channel when a call is received on it, even if a call is already being received on any of the other channels.

■ Temporary Delete

You can temporarily remove specific channels from the scanning sequence during Scan. When Scan pauses at a channel, you can remove that channel from the scanning sequence by pressing and holding the key programmed as **Temporary Delete** for 1 second or **Scan + Temporary Delete** for 3 seconds.

- You cannot remove a channel if there will be less than 2 channels available for scanning remaining.
- To add the removed channels back into the Scan list, simply exit Scan mode or switch the transceiver power OFF and then ON again.

■ Revert Channel

During Scan, pressing the **PTT** switch will automatically select the transceiver's Revert channel and you will begin transmitting. Your dealer can program the Revert channel using one of the following methods:

- **Selected:** The last channel selected prior to scanning is assigned as the Revert channel.
- **Selected + Talkback:** The last channel selected prior to scanning is assigned as the Revert channel. However, the transceiver also transmits on the channel where Scan is currently paused. This is the default Revert channel setting.
- **Priority:** If your dealer has programmed a Priority channel, it is the Revert channel.
- **Priority + Talkback:** If your dealer has programmed a Priority channel, it is the Revert channel. However, the transceiver also transmits on the channel where Scan is currently paused.

SCRAMBLER

Whereas the Quiet Talk and Digital Quiet Talk functions {page 15} allows you to ignore unwanted calls, Scrambler allows you to hold a conversation in complete privacy. When activated, any other party listening in on your channel will be unable to understand your conversation. The transceiver scrambles your voice so that anybody listening to your conversation will not be able to understand what you are saying.

In order for members of your own group to understand your call while you are using the Scrambler, all other members must also activate the Scrambler on their transceivers. This scrambles everybody's voice while transmitting and unscrambles the voice message on your own transceiver when you receive the message.

To activate the Scrambler, press the key programmed as **Scrambler**.

To deactivate the Scrambler, press the **Scrambler** key again.

OPTIONAL ACCESSORIES

KMC-17 (Speaker/ microphone)

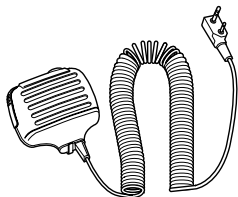

KMC-21 (Speaker/ microphone)

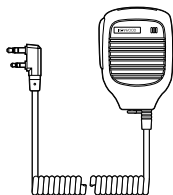

KHS-1 (Headset)

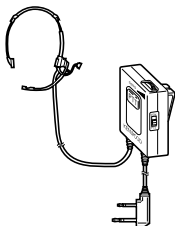

KHS-21 (Headset)



KWR-1 (Water resistant bag)

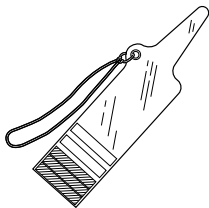

TROUBLESHOOTING GUIDE

Problem	Solution
Cannot turn the transceiver power ON.	<ul style="list-style-type: none">• The battery pack may be dead. Recharge or replace the battery pack.• The battery pack may not be installed correctly. Remove the battery pack and install again.
Battery power dies shortly after charging.	<ul style="list-style-type: none">• The battery pack life is finished. Replace the battery pack with a new one.
Cannot talk to or hear other members in your group.	<ul style="list-style-type: none">• Make sure you are using the same frequency and QT/DQT settings as the other members in your group.• Other group members may be using the Scrambler function. Turn on your transceiver's Scrambler.• Other group members may be too far away. Make sure you are within range of the other transceivers.
Other voices (besides group members') are present on the channel.	<ul style="list-style-type: none">• Change the QT/DQT settings. Make sure all group members change the settings on their transceivers to match the new QT/DQT setting.