

# KENWOOD

**DDX6021BT**  
**DDX6051BT**  
**DDX4021BT**  
**DDX4051BT**  
**DDX3021**  
**DDX3051**

---

MONITOR WITH DVD RECEIVER  
**INSTRUCTION MANUAL**

JVC KENWOOD Corporation



## Contents

---

<b>Before use .....</b>	<b>3</b>
How to reset your unit .....	3

## INTRODUCTIONS

---

<b>Initial Settings .....</b>	<b>5</b>
Initial setup .....	5
Adjusting the panel angle .....	5
Updating the system .....	6
Setting the security function .....	7

<b>Component names and functions .....</b>	<b>8</b>
--	----------

<b>Setting the clock .....</b>	<b>10</b>
--------------------------------	-----------

<b>Common operations .....</b>	<b>11</b>
--------------------------------	-----------

Turning on the power .....	11
Turning off the power .....	11
Adjusting the volume .....	11
Putting the unit in standby .....	11
Turning off the screen .....	11

<b>Switching screens .....</b>	<b>12</b>
--------------------------------	-----------

## AV SOURCE OPERATIONS

---

<b>Selecting the playback source....</b>	<b>13</b>
--	-----------

Displaying the source control screen .....	13
--	----

<b>Disc operations .....</b>	<b>14</b>
------------------------------	-----------

Playing a disc .....	14
Playable disc types .....	15
Playback operations .....	16
Settings for disc playback .....	20

<b>USB operations .....</b>	<b>21</b>
-----------------------------	-----------

Playing a USB device .....	21
----------------------------	----

<b>Listening to the iPod/iPhone device .....</b>	<b>23</b>
--	-----------

iPod/iPhone playback operations .....	24
Selecting a track/video from menu on the iPod/iPhone .....	25
Operating in iPod/iPhone control mode...25	

<b>Listening to the radio .....</b>	<b>26</b>
-------------------------------------	-----------

<b>Using other external components .....</b>	<b>31</b>
--	-----------

AV-IN .....	31
Using the external navigation unit .....	32

<b>Sound adjustment .....</b>	<b>33</b>
-------------------------------	-----------

Using the sound equalization .....	33
Adjusting the cross over frequency .....	34

<b>Changing the display design .....</b>	<b>35</b>
--	-----------

<b>Setting for video playback .....</b>	<b>37</b>
---	-----------

Picture adjustment .....	37
Changing the aspect ratio .....	38
Zooming picture .....	38

<b>Using a rear view camera .....</b>	<b>39</b>
---------------------------------------	-----------

<b>Setting menu items .....</b>	<b>40</b>
---------------------------------	-----------

Memorizing/recalling the settings .....	44
Locking the settings .....	44
Adjusting the touch position .....	44

## BLUETOOTH OPERATIONS

(Only for DDX6021BT/DDX6051BT/  
DDX4021BT/DDX4051BT)

---

<b>Information for using Bluetooth® devices .....</b>	<b>45</b>
---	-----------

<b>Bluetooth operations .....</b>	<b>45</b>
-----------------------------------	-----------

Connecting Bluetooth devices .....	46
Using the Bluetooth mobile phone .....	48
Using the Bluetooth audio player .....	53
Bluetooth device settings .....	53

## USING THE REMOTE CONTROLLER

---

<b>Overview .....</b>	<b>55</b>
-----------------------	-----------

<b>Operations from the remote controller .....</b>	<b>56</b>
--	-----------

## REFERENCE

---

<b>Maintenance .....</b>	<b>60</b>
--------------------------	-----------

<b>More about this unit .....</b>	<b>61</b>
-----------------------------------	-----------

<b>Troubleshooting .....</b>	<b>63</b>
------------------------------	-----------

<b>Accessories/Installation Procedure .....</b>	<b>67</b>
---	-----------

<b>Connecting Wires to Terminals .....</b>	<b>69</b>
--	-----------

<b>Connecting a USB device/iPod/iPhone .....</b>	<b>70</b>
--	-----------

<b>Connecting Other Products .....</b>	<b>71</b>
--	-----------

<b>Installing/Removing the Unit .....</b>	<b>72</b>
---	-----------

<b>Specifications .....</b>	<b>74</b>
-----------------------------	-----------

<b>KS-UBT1 (USB Bluetooth Adapter) .....</b>	<b>77</b>
--	-----------

# Before use

## ⚠ WARNINGS:

### (To prevent accidents and damage)

- DO NOT install any unit or wire any cable in a location where;
  - it may obstruct the steering wheel and gearshift lever operations.
  - it may obstruct the operation of safety devices such as air bags.
  - it may obstruct visibility.
- DO NOT operate the unit while driving. If you need to operate the unit while driving, be sure to look around carefully.
- The driver must not watch the monitor while driving.

## ⚠ Cautions on the monitor:

- The monitor built in this unit has been produced with high precision, but it may have some ineffective dots. This is inevitable and is not considered defective.
- Do not expose the monitor to direct sunlight.
- Do not operate the touch panel using a ball-point pen or similar tool with the sharp tip.  
Press the buttons on the touch panel with your finger directly (if you are wearing a glove, take it off).
- When the temperature is very cold or very hot...
  - Chemical changes occur inside, causing malfunction.
  - Pictures may not appear clearly or may move slowly. Pictures may not be synchronized with the sound or picture quality may decline in such environments.

### For safety...

- Do not raise the volume level too much, as this will make driving dangerous by blocking outside sounds, and may cause hearing loss.
- Stop the car before performing any complicated operations.

## Temperature inside the car...

If you have parked the car for a long time in hot or cold weather, wait until the temperature in the car becomes normal before operating the unit.

## ■ How to reset your unit

### DDX6021BT/DDX6051BT



### DDX4021BT/DDX4051BT/DDX3021/DDX3051



If the unit fails to operate properly, press the Reset button. The unit returns to factory settings when the Reset button is pressed (except the registered Bluetooth devices).

### How to read this manual:

- Illustrations of DDX6021BT are mainly used for explanation.
- This manual mainly explains operations using the buttons on the monitor panel and touch panel. For operations using the remote controller (RC-DV340: supplied only for DDX6021BT/DDX6051BT), see page 55.
- < > indicates the variable screens/ menus/operations/settings that appear on the touch panel.
- [ ] indicates the buttons on the touch panel.
- **Indication language:** English indications are used for the purpose of explanation. You can select the indication language from the <Setup> menu. (see page 43)

The displays and panels shown in this manual are examples used to provide clear explanations of the operations. For this reason, they may be different from the actual displays or panels.

This Product is not installed by the manufacturer of a vehicle on the production line, nor by the professional importer of a vehicle into an EU Member State.



**Declaration of Conformity with regard to the EMC Directive 2004/108/EC**

**Manufacturer:**

JVC KENWOOD Corporation  
3-12 Moriya-cho, Kanagawa-ku, Yokohama-shi,  
Kanagawa, 221-0022, Japan

**EU Representative's:**

Kenwood Electronics Europe BV  
Amsterdamseweg 37, 1422 AC UITHOORN, The  
Netherlands

**Information on Disposal of Old Electrical and Electronic Equipment and Batteries (applicable for EU countries that have adopted separate waste collection systems)**



Products and batteries with the symbol (crossed-out wheeled bin) cannot be disposed as household waste.



Old electrical and electronic equipment and batteries should be recycled at a facility capable of handling these items and their waste byproducts.



**Pb**

Contact your local authority for details in locating a recycle facility nearest to you.

Proper recycling and waste disposal will help conserve resources whilst preventing detrimental effects on our health and the environment.

Notice: The sign "Pb" below the symbol for batteries indicates that this battery contains lead.

**The marking of products using lasers**

**CLASS 1  
LASER PRODUCT**

The label is attached to the chassis/case and says that the component uses laser beams that have been classified as Class 1. It means that the unit is utilizing laser beams that are of a weaker class. There is no danger of hazardous radiation outside the unit

# INTRODUCTIONS

## Initial Settings

### Initial setup

When you power on the unit for the first time or reset the unit, the initial setting screen appears.

- You can also change the settings on the <Setup> screen. (☞ page 40)

1



<b>Language</b>	Select the text language used for on-screen information. (☞ page 43)
<b>Angle</b> Only for DDX6021BT/ DDX6051BT	Adjust the panel angle. (☞ the right column)
<b>AV Input</b>	Select an external component to play — <AV-IN2> or <iPod>. (☞ page 42)
<b>R-CAM Interrupt</b>	Select <ON> when connecting the rear view camera. (☞ page 42)
<b>Panel Color</b>	Select the color of the buttons on the monitor panel. (☞ page 35)

2 Finish the procedure.



### Adjusting the panel angle

(Only for DDX6021BT/DDX6051BT)

You can change the panel angle.

1 Select an angle (0 – 6).



To set the current position as the power off position, select <Memory>.

## Updating the system

You can update the system by connecting a USB device containing the update file.

### 1 Create an update file, copy it to a USB device, and connect it to the unit.

To connect a USB device, see page 70.

### 2 On <Top Menu>:



### 3



### 4



It may take a while.

If the update has been complete successfully, "Update Completed" appears. Reset the unit.

- \* If the update has failed, turn the power off and then on, and retry the update.
- \* Even if you have turned off the power during update, you can restart the update after the power is turned on. The update will be performed from the beginning.

## Setting the security function

You can set a security code to protect your receiver system against theft.

### ■ Registering the security code

#### 1 Display the security code setting screen.

On <Top Menu>:



- To clear the registered security code, perform step 1 and press [CLR] in <Security Code>.

#### 2 Enter a four-digit number (①), then confirm the entry (②).



#### 3 Repeat step 2 to confirm your security code.

Now, your security code is registered.

- When the unit is being reset or disconnected from battery, you are required to enter the security code. Enter the correct security code, then press [Enter].

### ■ Activating the security function

You can activate the security indicator to protect your receiver system against theft.

On <Setup>:







The security indicator on the monitor panel flashes when the vehicle ignition is off.

To cancel, select <OFF>.

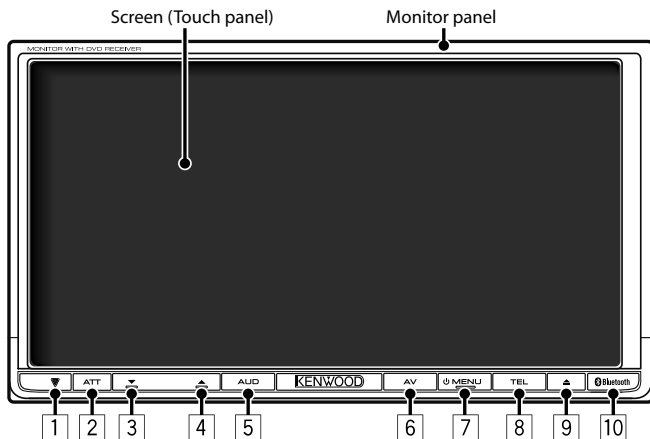
# Component names and functions

## DDX6021BT/DDX6051BT



- 1 Reset button/Power indicator/Security indicator
  - Resets the unit. (☞ page 3)
  - Lights up while the unit is turned on.
  - Flashes when the security function is activated. (☞ page 7)
- 2 ATT button (Press)
  - Attenuates the sound.
  - V.OFF button (Hold)
  - Turns off/on the screen. (☞ page 11)
- 3 Volume  (down) button (☞ page 11)
  - Decreases the volume.
- 4 Volume  (up) button (☞ page 11)
  - Increases the volume.
- 5 AUD button (Press)
  - Displays the **<Equalizer>** screen. (☞ page 33)
  - R-CAM button (Hold)
  - Displays the picture from the rear view camera.
- 6 AV button (Press)
  - Displays the current source screen.
  - AV OUT button (Hold)
  - Selects the AV source for external monitor or amplifier.
- 7 MENU/ button
  - Turns off the power. (Hold)
  - Turns on the power. (Press)
  - Displays the **<Top Menu>** screen. (Press) (☞ page 12)
- 8 TEL button (Press)
  - Displays the **<Handsfree>** screen. (☞ page 46)
  - FNC button (Hold)
  - Displays the source control screen. (☞ page 12)
- 9  (Eject) button
  - Ejects the disc (Tilts the monitor panel fully).
  - Opens/Closes the monitor panel.
- 10 Remote sensor



## DDX4021BT/DDX4051BT/DDX3021/DDX3051

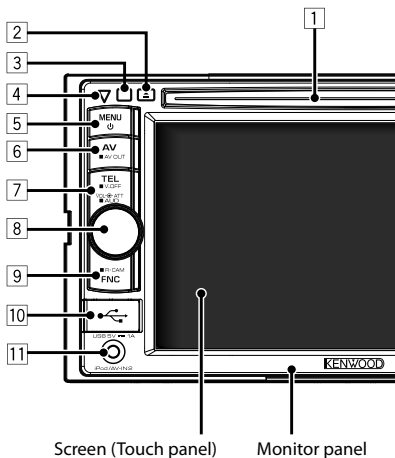

- 1 Loading slot
- 2 ▲ (Eject) button  
Ejects the disc.
- 3 Remote sensor
- 4 Reset button/Power indicator/Security indicator
  - Resets the unit. (☞ page 3)
  - Lights up while the unit is turned on.
  - Flashes when the security function is activated. (☞ page 7)
- 5 MENU/⏻ button
  - Turns off the power. (Hold)
  - Turns on the power. (Press)
  - Displays the <Top Menu> screen. (Press) (☞ page 12)

- 6 AV/AV OUT button
  - Displays the current source screen. (Press)
  - Selects the AV source for external monitor or amplifier. (Hold)

### 7 For DDX4021BT/DDX4051BT:

TEL/V.OFF button

- Displays the <Handsfree> screen. (Press) (☞ page 46)
- Turns off/on the screen. (Hold) (☞ page 11)

### For DDX3021/DDX3051:

AUD/V.OFF button

- Displays the <Equalizer> screen. (Press) (☞ page 33)
- Turns off/on the screen. (Hold) (☞ page 11)

### 8 VOL/ATT knob (☞ page 11)

- Attenuates the sound. (Press)
- Adjusts the audio volume. (Turn)

### For DDX4021BT/DDX4051BT only:

AUD button

- Displays the <Equalizer> screen. (Hold) (☞ page 33)

### 9 FNC/R-CAM button

- Displays the source control screen. (Press) (☞ page 12)
- Displays the picture from the rear view camera. (Hold)

### 10 USB input terminal

### 11 iPod/AV-IN2 input terminal

### Caution on volume setting:

Digital devices (CD/USB) produce very little noise compared with other sources. Lower the volume before playing these digital sources to avoid damaging the speakers by sudden increase of the output level.

You can change the color of the buttons on the monitor panel. (☞ page 35)

# Setting the clock

## 1 Display <Top Menu> screen.



## 2 Display <Setup> screen.



## 3

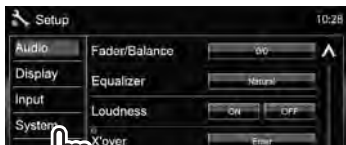

## 4 Set the clock time.



<NAV>*	Synchronizes the clock time with the connected navigation unit.
<Radio Data System>	Synchronizes the clock time with FM Radio Data System.
<OFF>	Sets the clock manually. (see below)



① Adjust the hour

② Adjust the minute

**[Reset]:** Sets the minute to "00."

Example:

3:00 – 3:29 → 3:00

3:30 – 3:59 → 4:00

## 5 Finish the procedure.



\* Appears only when the navigation unit is connected.

# Common operations

## Turning on the power

**DDX6021BT/  
DDX6051BT**



**DDX4021BT/  
DDX4051BT/  
DDX3021/DDX3051**



## Turning off the power

**DDX6021BT/  
DDX6051BT**



**DDX4021BT/  
DDX4051BT/  
DDX3021/DDX3051**



## Adjusting the volume

*To adjust the volume (00 to 35)*

**DDX6021BT/DDX6051BT**

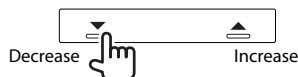

**DDX4021BT/DDX4051BT/DDX3021/  
DDX3051**



*To attenuate the sound*

**DDX6021BT/  
DDX6051BT**



**DDX4021BT/  
DDX4051BT/  
DDX3021/DDX3051**



The ATT indicator lights up.

**To cancel the attenuation**, press the ATT button (DDX6021BT/DDX6051BT) or VOL/ATT knob (DDX4021BT/DDX4051BT/DDX3021/DDX3051) again.

## Putting the unit in standby

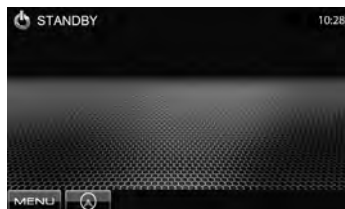
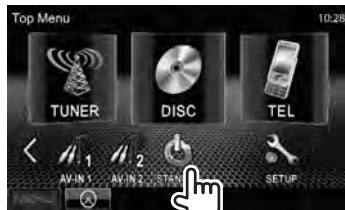

## Turning off the screen

**DDX6021BT/DDX6051BT**



**DDX4021BT/  
DDX4051BT**

**DDX3021/  
DDX3051**

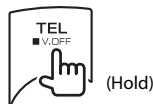

The screen is turned off.

**To turn on the screen**, press MENU/⏻.

# Switching screens

## Source control screen



Displays the navigation screen.\*  
(page 32)

\* Appears only when a navigation unit is connected.

## <Top Menu>

- Changes the AV source.
- Displays the <Setup> screen.

You can select 3 items to be displayed in this area. (page 13)



page 11

## <Setup>

Changes the detailed settings.

Changes the page



Press  to return to the previous screen.

## Touch screen operation

Displays the video control menu while playing a video.

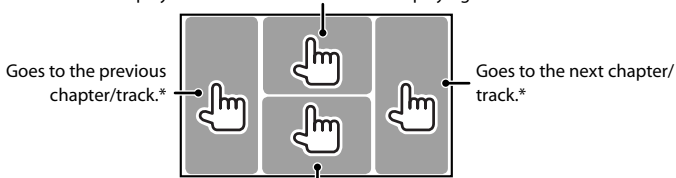

Displays the source control screen while playing a video.

- The operation buttons disappear by touching the screen or when no operation is done for about 5 seconds.

\* Not available for video from an external component and rear view camera.

# AV SOURCE OPERATIONS

## Selecting the playback source

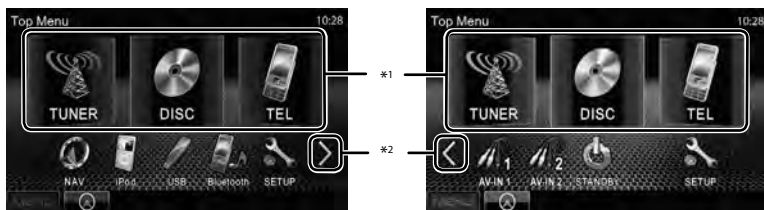

<b>NAV</b> *3 (📖 page 32)	Displays the navigation screen when a navigation unit is connected.
<b>DISC</b> (📖 page 14)	Plays a disc.
<b>TEL</b> *4 (📖 page 49)	Displays the Bluetooth mobile phone setting screen.
<b>USB</b> (📖 page 21)	Plays files on a USB device.
<b>iPod</b> *5 (📖 page 23)	Plays an iPod/iPhone.
<b>TUNER</b> (📖 page 26)	Switches to the radio broadcast.
<b>AV-IN 1/AV-IN 2</b> *5 (📖 page 31)	Switches to an external component connected to AV-IN input terminal.
<b>Bluetooth</b> *4 (📖 page 53)	Plays a Bluetooth audio player.

\*1 You can select 3 items to be displayed in this area. (📖 page 41)

\*2 Switches between the previous and next pages.

\*3 When no navigation unit is connected, "No Navigation" appears.

\*4 Only for DDX6021BT/DDX6051BT/DDX4021BT/DDX4051BT.

\*5 Select an appropriate input setting on <AV Input>. (📖 page 42)

## Displaying the source control screen

On each playback screen, perform the following:



or

**DDX6021BT/DDX6051BT**



**DDX4021BT/DDX4051BT/DDX3021/  
DDX3051**



- For DDX6021BT/DDX6051BT, pressing and holding TEL hides the operation buttons. For DDX4021BT/DDX4051BT/DDX3021/DDX3051, pressing FNC/R-CAM hides the operation buttons.
- The operation buttons disappear by touching the screen or when no operation is done for about 5 seconds.

# Disc operations

## Playing a disc

- If a disc does not have a disc menu, all tracks on it will be played repeatedly until you change the source or eject the disc.

### ■ Inserting a disc

**DDX6021BT/DDX6051BT**

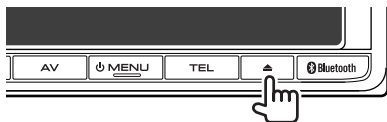

Label side

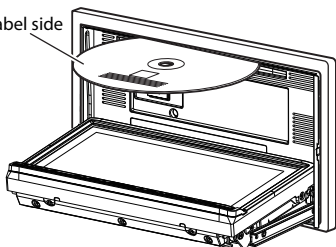

**DDX4021BT/DDX4051BT/DDX3021/DDX3051**

Label side

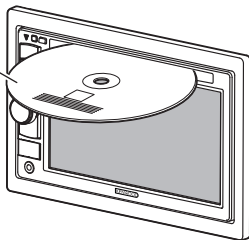

The source changes to **"DISC"** and playback starts.

- The IN indicator lights up while a disc is inserted.

- If "⊘" appears on the screen, the unit cannot accept the operation you have tried to do.
  - In some cases, without showing "⊘," operations will not be accepted.
- When playing back a multi-channel encoded disc, the multi-channel signals are downmixed to stereo.

### ■ To eject a disc

**DDX6021BT/DDX6051BT**

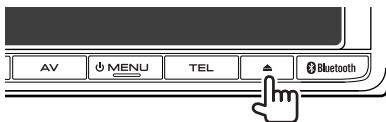

**DDX4021BT/DDX4051BT/DDX3021/DDX3051**



- You can eject a disc when playing another AV source.
- If the ejected disc is not removed within 15 seconds, the disc is automatically inserted again into the loading slot to protect it from dust.

**When removing a disc,** pull it horizontally.

### **Closing the monitor panel** **(For DDX6021BT/DDX6051BT)**

After removing the disc, press the eject button again. The monitor panel closes.

## Playable disc types

Disc type	Recording format, file type, etc	Playable
DVD	DVD-Video * <sup>1</sup> Region Code: • For DDX6021BT/DDX4021BT/DDX3021: 2 • For DDX6051BT/DDX4051BT/DDX3051: 5	✓OK
	DVD-Audio/DVD-ROM	✗NO
DVD Recordable/ Rewritable (DVD-R/-RW * <sup>2</sup> , +R/+RW * <sup>3</sup> ) • DVD Video: UDF bridge • DVD-VR • DivX/MPEG1/MPEG2/ JPEG/MP3/WMA/WAV/AAC: ISO 9660 level 1, level 2, Romeo, Joliet	DVD-Video	✓OK
	DVD-VR * <sup>4</sup>	
	DivX/MPEG1/MPEG2	
	JPEG	
	MP3/WMA/WAV/AAC	✗NO
MPEG4/DVD+VR/DVD-RAM		
Dual Disc	DVD side	✓OK
	Non-DVD side	✗NO
CD/VCD	DTS-CD/Audio CD/CD Text (CD-DA)	✓OK
	VCD (Video CD)	
	SVCD (Super Video CD)/CD-ROM/CD-I (CD-I Ready)	✗NO
CD Recordable/ Rewritable (CD-R/-RW) • ISO 9660 level 1, level 2, Romeo, Joliet	CD-DA	✓OK
	VCD (Video CD)	
	DivX/MPEG1/MPEG2	
	JPEG	
	MP3/WMA/WAV/AAC	
	MPEG4	✗NO

\*<sup>1</sup> If you insert a DVD Video disc of an incorrect Region Code, "Region code error" appears on the screen.

\*<sup>2</sup> DVD-R recorded in multi-border format is also playable (except for dual layer discs). DVD-RW dual layer discs are not playable.

\*<sup>3</sup> It is possible to play back finalized +R/+RW (Video format only) discs. "DVD" is selected as its disc type when a +R/+RW disc is loaded. +RW double layer discs are not playable.

\*<sup>4</sup> This unit cannot play back contents protected with CPRM (Content Protection for Recordable Media).

### Caution for DualDisc playback

The Non-DVD side of a "DualDisc" does not comply with the "Compact Disc Digital Audio" standard. Therefore, the use of Non-DVD side of a DualDisc on this product may not be recommended.

## Playback operations

To display the source control screen, page 13.

For DVD/DVD-VR/VCD/DivX/MPEG1/MPEG2/JPEG

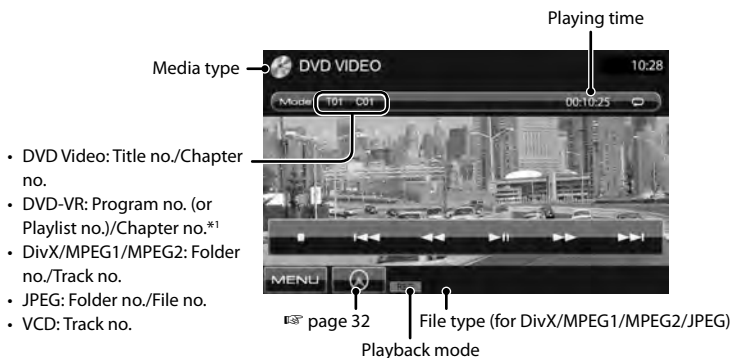

- DVD Video: Title no./Chapter no.
- DVD-VR: Program no. (or Playlist no.)/Chapter no.\*1
- DivX/MPEG1/MPEG2: Folder no./Track no.
- JPEG: Folder no./File no.
- VCD: Track no.

	Selects playback mode. ( page 19)
	Starts/Pauses playback.
	Stops playback.
	<ul style="list-style-type: none"> <li>• Selects chapter/track. (Press)</li> <li>• Reverse/forward search.*4 (Hold)</li> </ul>

	<ul style="list-style-type: none"> <li>• Reverse/forward search during playback.*4</li> <li>• Plays back in slow-motion during pause.</li> </ul>
<b>[Mode]</b> *5	Changes the settings for disc playback. ( page 20)
<b>[MENU]</b>	Displays <Top Menu> screen.

• For DivX/MPEG1/MPEG2/JPEG, the following buttons also appear:

	Selects folder.
--	-----------------

	Displays folder/track list. ( page 17)
--	--

\*1 To display the Original Program/Playlist screen, page 18.

\*2 Does not appear for DVD/DVD-VR/JPEG.

\*3 Appears only for DVD/DVD-VR/VCD.

\*4 Search speed varies depending on the type of disc or file.

\*5 Does not appear for VCD.



To display the source control screen, page 13.

### For CD/MP3/WMA/WAV/AAC

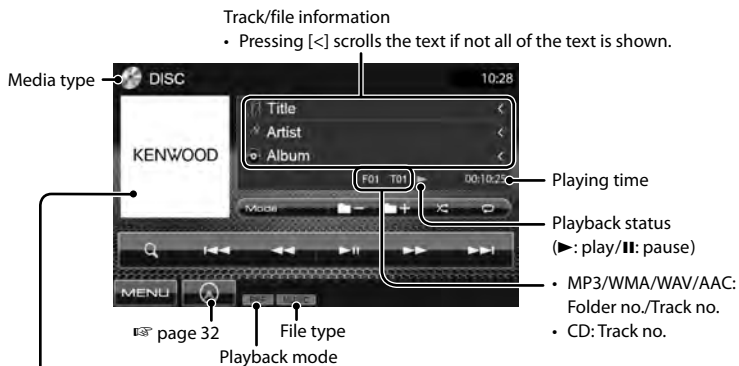

While playing, the jacket picture is shown if the file has the tag data including the jacket picture.

	Selects playback mode. ( page 19)
*1	Displays folder/track list. ( below)
	Starts/Pauses playback.
*1	Selects folder.

	Selects track.
	Reverse/forward search.*2
<b>[Mode]</b> *1	Changes the settings for disc playback. ( page 20)
<b>[MENU]</b>	Displays <Top Menu> screen.

\*1 Does not appear for CD.

\*2 Search speed varies depending on the type of disc or file.

### Selecting folder/track on the list

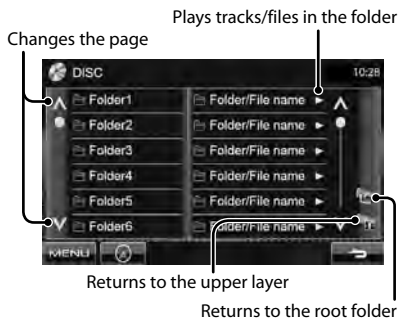

### Playing Recordable/Rewritable discs

- This unit can recognize a total of 5000 files and 250 folders (a maximum of 999 files per folder).
- Use only “finalized” discs.
- This unit can play back multi-session discs; however, unclosed sessions will be skipped while playing.
- Some discs or files may not be played back due to their characteristics or recording conditions.

## ■ Video menu operations

You can display the video menu screen while watching the playback pictures on the screen.

- Available items on the screen differ depending on the types of the loaded disc and playback files.
- The operation buttons disappear by touching the screen or when no operation is done for about 5 seconds.



- The screen for MPEG1/MPEG2 differs from the above.



<b>[Audio]</b>	Selects the audio type. <ul style="list-style-type: none"> <li>• For DVD-VR: Selects the audio channel (ST: stereo, L: left, R: right).</li> </ul>
<b>[Subtitle]</b>	Selects the subtitle type.
<b>[Angle]</b>	Selects view angle.
<b>[MENU]</b>	Displays the disc menu (DVD)/playlist (DVD-VR).
<b>[T MENU]</b>	Displays the disc menu (DVD)/original program (DVD-VR).
<b>[CUR]</b>	Displays the menu/playlist/original program item selecting screen. <ul style="list-style-type: none"> <li>• <b>[▲]</b> <b>[▼]</b> <b>[◀]</b> <b>[▶]</b>: Selects an item.               <ul style="list-style-type: none"> <li>– For DivX only</li> <li>– <b>[◀]</b> <b>[▶]</b>: Skips back or forward by about 5 minutes.</li> </ul> </li> <li>• <b>[ENTER]</b>: Confirms the selection.</li> <li>• <b>[RETURN]</b>: Returns to the previous screen.</li> </ul>
<b>[Highlight]</b>	Switches to the direct menu selection mode. Press the target item to select.
<b>[Picture Adjust]</b>	Displays picture adjustment screen. (☞ page 37)
<b>[Aspect]</b>	Selects aspect ratio. (☞ page 38)
<b>[ZOOM]</b>	Displays the picture size selecting screen. (☞ page 38)

## Only for VCD

1



2



Direct selecting buttons (see below)

<b>[Audio]</b>	Selects the audio channel (ST: stereo, L: left, R: right).
<b>[Return]</b>	Displays the previous screen or the menu.
<b>[MENU]</b>	Displays the disc menu.
<b>[Picture Adjust]</b>	Displays picture adjustment screen. (see page 37)
<b>[Aspect]</b>	Selects aspect ratio. (see page 38)
<b>[ZOOM]</b>	Displays the picture size selecting screen. (see page 38)
<b>[Direct]</b>	Displays/hides the direct selecting buttons. (see below)

- To select a track directly



- To switch between chapter/track entry and title/folder entry, press **[Direct/CLR]**.
- When you enter a wrong number, press **[Direct/CLR]** to delete the last entry.

- To deactivate the PBC function, press **[ ]** then the direct selecting buttons to select a track number.

## Selecting playback mode

For DVD/DVD-VR



Selects Repeat playback mode

For VCD (without PBC)/CD/DivX/MPEG1/  
MPEG2/MP3/WMA/WAV/AAC



Selects Random playback mode\*

Selects Repeat playback mode\*



- \* You cannot activate the repeat mode and the random mode at the same time.

- Each time you press the button, the playback mode changes. (The corresponding indicator lights up.)
  - Available items differ depending on the types of loaded disc and playback file.

Indicator	Playback mode
<b>C-REP</b>	Repeats current chapter.
<b>T-REP</b>	Repeats current title/program.
<b>REP</b>	Repeats current track.
<b>FO-REP</b>	Repeats all tracks of the current folder.
<b>RDM</b>	Randomly plays all tracks.
<b>FO-RDM</b>	Randomly plays all tracks of current folder, then tracks of next folders.

**To cancel**, press the button repeatedly until the indicator disappears.

## Settings for disc playback

Disc Setup items		Selectable setting/item	Initial: <u>Underlined</u>
For DVD/DVD-VR	<b>Menu Language</b>	Select the initial disc menu language; Initial <b>English</b> (Ⓜ page 62).	
	<b>Subtitle Language</b>	Select the initial subtitle language or erase the subtitle ( <b>OFF</b> ); Initial <b>English</b> (Ⓜ page 62).	
	<b>Audio Language</b>	Select the initial audio language; Initial <b>English</b> (Ⓜ page 62).	
	<b>Down Mix</b>	When playing back a multi-channel disc, this setting affects the signals reproduced through the front and/or rear speakers. <b>◆ Dolby Surround</b> : Select this to enjoy multi-channel surround audio with Dolby Surround. <b>◆ Stereo</b> : Normally select this.	
	<b>Dynamic Range Control</b>	You can change the dynamic range while playing Dolby Digital software. <b>◆ Wide</b> : Select this to enjoy a powerful sound at a low volume level with its full dynamic range. <b>◆ Normal</b> : Select this to reduce the dynamic range a little. <b>◆ Dialog</b> : Select this to reproduce the movie dialog more clearly.	
For discs except VCD/CD	<b>Screen Ratio</b>	Select the monitor type to watch a wide screen picture on the external monitor. <b>◆ 16:9</b>  <b>◆ 4:3 LB (Letterbox)</b>  <b>◆ 4:3 PS (PanScan)</b> 	
For discs containing audio/video/picture files	<b>File Type</b>	Select the playback file type when a disc contains different types of files. <b>◆ Audio</b> : Plays back audio files. <b>◆ Still Image</b> : Plays back JPEG files. <b>◆ Video</b> : Plays back DivX/MPEG1/MPEG2 files. <b>◆ Audio&amp;Video</b> : Plays back audio files and DivX/MPEG1/MPEG2 files. <ul style="list-style-type: none"> <li>• For playable file types, Ⓜ page 15.</li> <li>• If the disc contains no files of the selected type, the existing files are played in the following order: audio, video, then still image.</li> </ul>	

# USB operations

## Playing a USB device

- This unit can play JPEG/DivX/MPEG1/MPEG2/MP3/WMA/WAV/AAC files stored in a USB mass storage class device.
- This unit can recognize a total of 5 000 files and 250 folders (a maximum of 999 files per folder).
- Make sure all important data has been backed up to avoid losing the data.

### ■ Connecting a USB device

You can connect a USB mass storage class device such as a USB memory, Digital Audio Player etc. to the unit.

- You cannot connect a computer or portable HDD to the USB input terminal.
- To connect a USB device,  page 70.

### ***When a USB device is connected...***

The source changes to **"USB"** and playback starts.

- All tracks in the USB device will be played repeatedly until you change the source.

### ***To disconnect the USB device safely***

Press , then disconnect the USB device after "No Device" appears.

### ***Cautions:***

- This unit may not play back files in a USB device properly when using a USB extension cord.
- USB devices equipped with special functions such as data security functions cannot be used with the unit.
- Do not use a USB device with 2 or more partitions.
- Depending on the shape of the USB devices and connection ports, some USB devices may not be attached properly or the connection might be loose.
- This unit cannot recognize a USB device whose rating is other than 5 V and exceeds 500 mA.
- This unit may not recognize a memory card inserted into the USB card reader.
- When connecting with a USB cable, use the USB 2.0 cable.
- The maximum number of characters for:
  - Folder names : 50 characters
  - File names : 50 characters
- Avoid using the USB device if it might effect driving safety.
- Do not pull out and connect the USB device repeatedly while "Reading..." is shown on the screen.
- Electrostatic shock at connecting a USB device may cause abnormal playback of the device. In this case, disconnect the USB device then reset this unit and the USB device.
- Operation and power supply may not work as intended for some USB devices.
- Do not leave a USB device in the car, or expose to direct sunlight or high temperature to avoid deformation or damage to the device.

## To display the source control screen, page 13.

While playing, the jacket picture is shown if the file has the tag data including the jacket picture.



Track/file information (for MP3/WMA/WAV/AAC)









- Pressing [**<**] scrolls the text if not all of the text is shown.

Playing time  
Playback status  
(▶: play/||: pause)

page 32

Playback mode  
File type

- MP3/WMA/WAV/AAC: Folder no./Track no.
- JPEG: Folder no./File no.

	Selects repeat playback mode. *1*2 <ul style="list-style-type: none"> <li><b>REP</b>: Repeats current track.</li> <li><b>FO-REP</b>: Repeats all tracks of the current folder.</li> </ul>		Displays folder/track list. (page 17)
	Selects random playback mode. *1*2 <ul style="list-style-type: none"> <li><b>RDM</b>: Randomly plays all tracks.</li> <li><b>FO-RDM</b>: Randomly plays all tracks of the folder.</li> </ul>		Starts/Pauses playback.
	Press this button before disconnecting. (page 21)		Selects track.
			Reverse/forward search.*3
			Selects folder.
		<b>[Mode]</b>	Changes the settings for file playback. (below)
		<b>[MENU]</b>	Displays <Top Menu> screen.

- Available items differ depending on the types of playback file.



\*1 To cancel random or repeat mode, press the button repeatedly until the indicator disappears.

\*2 You cannot activate the repeat mode and the random mode at the same time.

\*3 Search speed varies depending on the type of disc or file.

### Setting <Screen Ratio>

Select the monitor type to watch a wide screen picture on the external monitor.

<b>16:9</b>	
<b>4:3 LB</b> (Letterbox)	
<b>4:3 PS</b> (PanScan)	

### Setting <File Type>

<b>Audio</b>	Plays back audio files.
<b>Still Image</b>	Plays back JPEG files.
<b>Video</b>	Plays back DivX/MPEG1/MPEG2 files.
<b>Audio&amp;Video</b>	Plays back audio files and DivX/MPEG1/MPEG2 files.

- If the USB device contains no files of the selected type, the existing files are played in the following order: audio, video, then still image.

### Setting <Drive Select>

Press [**Next**] to switch to another USB device when multiple USB devices are connected via a USB hub or the like.

# Listening to the iPod/iPhone device

## ■ Preparation

- Connect iPod/iPhone. (☞ page 70)
- Use the following cables:
  - **To watch the video and to listen to the music (analog):** USB Audio and Video cable for iPod/iPhone—KCA-iP202 (optional accessory)
  - **To listen to the music (digital):** USB Audio cable for iPod/iPhone—KCA-iP102 (optional accessory)
- Select appropriate input settings on **<AV Input>** according to the connection method (☞ the right column).
- Do not use extension cables.

iPod/iPhone that can be connected to this unit:

Made for

- iPod with video
- iPod classic
- iPod nano (6th Generation)
- iPod nano (5th Generation)
- iPod nano (4th Generation)
- iPod nano (3rd Generation)
- iPod nano (2nd Generation)
- iPod nano (1st Generation)
- iPod touch (4th Generation)
- iPod touch (3rd Generation)
- iPod touch (2nd Generation)
- iPod touch (1st Generation)
- iPhone 4
- iPhone 3GS
- iPhone 3G
- iPhone

## Settings for iPod playback

When the source is "iPod"...



<b>Audiobooks</b>	Selects the speed of audio books.
<b>Artwork</b>	Shows/hides the iPod artwork.

## Setting <AV Input>

You can change the setting only when the unit is in standby.

### 1 On <Top Menu>:



<b>AV-IN2</b>	Select this when connecting the iPod/iPhone using the USB Audio cable for iPod/iPhone.
<b>iPod</b>	Select this when connecting the iPod/iPhone using the USB Audio and Video cable for iPod/iPhone.

## iPod/iPhone playback operations

To display the source control screen, [page 13](#).

- Select "iPod" as the source. ([page 13](#))
- The operations explained in this manual are under the condition when the unit is selected for controlling playback. ([page](#) below)

While playing, Artwork (the picture displayed on the screen of iPod/iPhone) is shown if the song contains the Artwork.\*1

Song/video information

- Pressing [ < ] scrolls the text if not all of the text is shown.

Playing time

Playback status (▶: play/||: pause)

[page 32](#) Playback mode

<b>[MENU]</b>	Displays <Top Menu> screen.	<b>[Q]</b>	Displays the Music/Video menu on the iPod/iPhone. ( <a href="#">page 25</a> )
<b>[Mode]</b>	Changes the settings for iPod playback. ( <a href="#">page 23</a> )	<b>[ &lt;&lt; ]</b>	Selects a track/video.*3
<b>[▶  ]</b>	Starts/Pauses playback.	<b>[&gt;&gt; ]</b>	Reverse/forward search.
<b>[↺]</b>	Selects Repeat playback mode.*2	<b>[&gt;&gt;&gt;]</b>	
<b>[X]</b>	Selects Random playback mode.*2	<b>[APP]</b>	Select iPod to play back using iPod/iPhone—iPod control mode.*4 ( <a href="#">page 25</a> )
	<ul style="list-style-type: none"> <li>• <b>REP:</b> Functions the same as "Repeat One."</li> <li>• <b>RDM:</b> Functions the same as "Shuffle Songs."</li> <li>• <b>A-RDM:</b> Functions the same as "Shuffle Albums."</li> </ul>		

\*1 For changing the Artwork display setting, [page 23](#).

\*2 To cancel random or repeat mode, press the button repeatedly until the indicator disappears. Not available in iPod control mode. ([page 25](#))

\*3 You cannot resume playback for video sources.

\*4 When using iPod nano (1st Generation) or iPod with video, you can control playback only from the unit.

- When you turn on this unit, the iPod/iPhone is charged through the unit.
- The text information may not be displayed correctly.

- For some iPod/iPhone models, the performance may be abnormal or unstable during operation. In this case, disconnect the iPod/iPhone device, then check its condition. If the performance is not improved or is slow, reset your iPod/iPhone.
- For the latest compatible list and software version of iPod/iPhone, see: [www.kenwood.com/cs/ce/ipod](http://www.kenwood.com/cs/ce/ipod)



## Selecting a track/video from menu on the iPod/iPhone

1

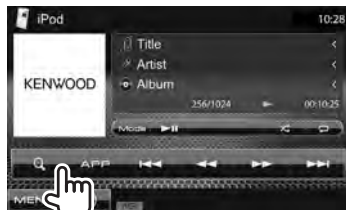

## 2 Select the menu (Music or Video) (1), a category (2), then a desired item (3).

- Select the item in the selected layer until a desired track starts playing.

### Music menu:

Switches between Music (🎵) and Video (📺)



Returns to the previous layer

Returns to the top layer

### Video menu:

Switches between Music (🎵) and Video (📺)



- Available categories differ depending on the type of your iPod/iPhone.

## Operating in iPod/iPhone control mode

You can play back the audio/video using iPod/iPhone itself instead of the unit.

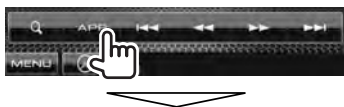

### Audio:

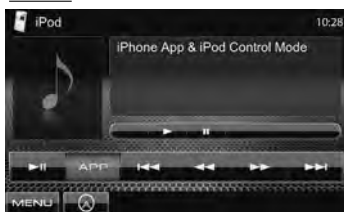

### Video:



- When you are using Garmin StreetPilot® Onboard, the screen appears. For Garmin StreetPilot® Onboard for iPhone, visit the Garmin web site: [www.garmin.com](http://www.garmin.com)

### Garmin App:



- The current position of your vehicle appears on the map. When the vehicle runs, the map scrolls.
- The screens of the iPhone and unit are not the same.
- To return to the normal mode, press [APP].

# Listening to the radio

Text information

Scrolls the text information

Standby reception indicators (☞ page 29)

☞ page 32

ST indicator

AF indicator (☞ page 30)

LO.S indicator (☞ page 27)

Seek mode indicator

RDS indicator

EON indicator: Lights up when a Radio Data System station is sending EON signals.

- The ST indicator lights up when receiving an FM stereo broadcast with sufficient signal strength.

<b>[P1] – [P6]</b>	<ul style="list-style-type: none"> <li>Turns in the preset station. (Press)</li> <li>Presets the currently tuned station. (Hold)</li> </ul>	<b>[PTY]*</b>	Enters FM Radio Data System program search mode. (☞ page 28)
<b>[Mode]</b>	Displays tuner setting screen. (☞ page 27)	<b>[AM]</b>	Selects AM band.
<b>[TI]</b>	Activates/deactivates TI standby reception mode. (☞ page 29)	<b>[FM]</b>	Selects FM band. → FM1 → FM2 → FM3
<b>[Mono]*</b>	Activates/deactivates monaural mode for better FM reception. (Stereo effect will be lost.) <ul style="list-style-type: none"> <li>The MONO indicator lights up while monaural mode is activated.</li> </ul>	<b>[SEEK]</b>	Changes the seek mode. <ul style="list-style-type: none"> <li><b>AUTO1:</b> Auto Search</li> <li><b>AUTO2:</b> Tunes in stations in memory one after another.</li> <li><b>MANU:</b> Manual Search</li> </ul>
<b>[Text]</b>	Displays/hides the information of the current station (☞ page 27).	<b>[&lt;&lt;&lt;] [&gt;&gt;&gt;]</b>	Searches for a station. <ul style="list-style-type: none"> <li>The search method differs according to the selected seek mode (☞ above)</li> </ul>
		<b>[MENU]</b>	Displays <Top Menu> screen.

\* Appears only when FM is selected as the source.

## Displaying the information of the current station

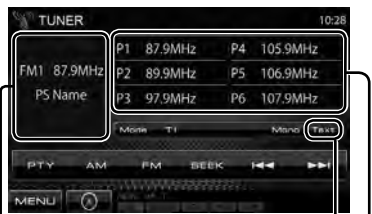

The station frequency currently tuned in/PS (station name) for FM Radio Data System when PS signal is coming in

Displays the text information

Preset list

## To tune in FM stations only with strong signals—Local Seek

1



2



**ON** Select this to tune in only to stations with sufficient signal strength. The LOS indicator lights up.

**OFF** Deactivate the function.

## Storing stations in memory

You can preset six stations for each band.

### Automatic presetting—AME (Auto Memory)

1



2



Local stations with the strongest signals are searched and stored automatically.

### Manual presetting

1 Tune in to a station you want to preset. (see page 26)

2 Select a preset number.



The station selected in step 1 is stored.

## ■ Selecting a preset station



The following features are available only for FM Radio Data System stations.

## ■ Searching for FM Radio Data System program—PTY Search

You can search for your favorite programs being broadcast by selecting the PTY code for your favorite programs.

1



## 2 Select a PTY code.

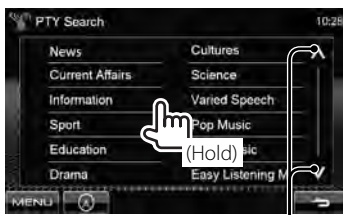

Changes the page

PTY Search starts.

If there is a station broadcasting a program of the same PTY code as you have selected, that station is tuned in.

- Only English/Spanish/French/German/Dutch/Portuguese are available for the text language here. If another language has been selected in <Language> (page 43), the text language is set to English.

## ■ Activating/deactivating TI/News Standby Reception

### TI Standby Reception



TI indicator

TI indicator	TI Standby Reception
Lights in white	The unit will temporarily switch to Traffic Information (TI) if available.
Lights in orange	Not yet activated. Tune in to another station providing the Radio Data System signals.
Goes off	Deactivated.

- The volume adjustment for Traffic Information is automatically memorized. The next time the unit switches to Traffic Information, the volume is set to the previous level.

### News Standby Reception

1



NEWS indicator

2



<b>00min – 90min</b>	Activates News Standby Reception (the NEWS indicator lights up). Select the period of time to disable interruption.
<b>OFF</b>	Deactivates News Standby Reception.

- The volume adjustment while receiving News is automatically memorized. The next time the unit switches to News, the volume is set to the previous level.

## ■ Tracing the same program— Network-Tracking Reception

When driving in an area where FM reception is not sufficient enough, this unit automatically tunes in to another FM Radio Data System station of the same network, possibly broadcasting the same program with stronger signals.

When shipped from the factory, Network-Tracking Reception is activated.

### To change the Network-Tracking Reception setting

1



2



<b>AF</b>	Switches to another station. The program may differ from the one currently received (the AF indicator lights up).
<b>AF Reg</b>	Switches to another station broadcasting the same program (the AF indicator lights up).
<b>OFF</b>	Cancels.

- The RDS indicator lights up when the Network-Tracking Reception is activated and an FM Radio Data System station is found.

## ■ Automatic TI station seek— Auto TP Seek

When traffic information station reception is poor, the unit automatically searches for another station that can be received better.

### To activate Auto TP Seek

1



2



To deactivate, select <OFF>.

# Using other external components

To display the source control screen,  page 13.



[Mode]	Changes the AV-IN name. <ul style="list-style-type: none"><li>• Press [◀] or [▶] to select an AV-IN name.</li><li>• This setting does not affect the source name "AV-IN 1"/"AV-IN 2" displayed on &lt;Top Menu&gt;.</li></ul>
[MENU]	Displays <Top Menu> screen.

## AV-IN

You can connect an external component to the AV-IN terminal.

### Preparation:

If you want to use AV-IN2, select <AV-IN2> for <AV Input> setting. ( page 42)

### 1 Connect an external component.

To connect it,  page 70, 71.

### 2 Select "AV-IN 1" or "AV-IN 2" as the source. ( page 13)

### 3 Turn on the connected component and start playing the source.

## Using the external navigation unit

You can connect a navigation unit (KNA-G620T/KNA-G630: optional accessory) to the navigation input terminal so that you can view the navigation screen. (✎ page 71)

The navigation guidance comes out through the front speakers even when you listen to an audio source.

### To view the navigation screen

On <Top Menu>:



or

On any screen:



The navigation screen is activated.

- While the navigation screen is displayed, the touch panel operations are available only for using navigation function.
- The aspect ratio of the navigation screen is fixed to <FULL> regardless of the <Aspect> setting (✎ page 38).

### To cancel the navigation screen

**DDX6021BT/  
DDX6051BT**

**DDX4021BT/  
DDX4051BT/  
DDX3021/DDX3051**



### Settings for navigation unit

**1** On <Top Menu>:



**2**

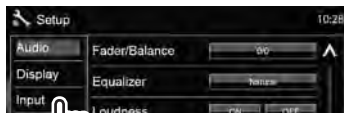

**3**



<b>Guidance</b>	Select front speakers used for the navigation guidance.
<b>Volume</b>	Adjust the volume of the navigation guidance. (0 to 35)
<b>NAV Mute</b>	Select <ON> to attenuate the sound coming through speakers other than the front speakers during navigation guidance.
<b>NAV Setup</b>	Press [Enter] to display the setup screen for the navigation unit. See the instruction manual supplied for the navigation unit.



# Sound adjustment

## Using the sound equalization

- The adjustment is memorized for each source until you adjust the sound again. If the source is a disc, the adjustment is stored for each of the following categories.
  - DVD/DVD-VR
  - VCD/CD
  - DivX/MPEG1/MPEG2/MP3/WMA/WAV/AAC
- **You cannot adjust the sound when the unit is in standby.**

### ■ Selecting a preset sound mode

1 On <Top Menu>:



2



3 Select a sound mode.



Changes the page

### ■ Storing your own adjustment

*Customizing preset sound mode*

- 1 Select a sound mode. (E<sup>3</sup> "Selecting a preset sound mode")
- 2 Set <SystemQ- Ex> to <OFF> (①), then press [Tone] (②).

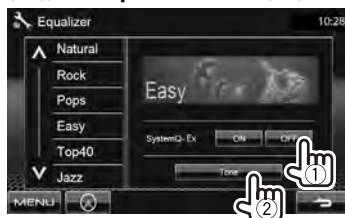

- 3 Adjust the level of each band (①), then select the subwoofer level\* (②).

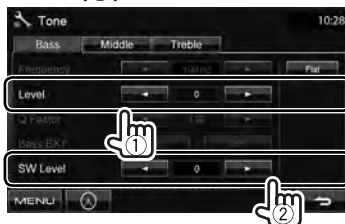

The adjustments are stored and <User> is activated.

\* Adjustable only when the subwoofer is activated. (E<sup>3</sup> page 40)

## Adjusting the sound precisely

- 1 Perform steps 1 and 2 of "Selecting a preset sound mode," then...



2



- 3 Adjust the sound of each band.



<b>Flat</b>	Changes level of Bass/Middle/Treble to 0.
<b>Frequency</b>	Selects frequency.
<b>Level</b>	Adjusts level.
<b>Q Factor</b>	Adjusts the width of the frequency.
<b>Bass EXT</b>	Activates/deactivates bass.
<b>SW Level</b>	Adjusts subwoofer level.*

The adjustments are stored and <User> is activated.

\* Adjustable only when the subwoofer is activated. (☞ page 40)

## Adjusting the cross over frequency

- 1 On <Top Menu>:



2



- 3 Select the item to adjust, then make adjustment.

Adjusts the cross over for front or rear speakers (high pass filter).



Adjusts the cross over for subwoofer (low pass filter).<sup>\*1</sup>



Adjusts the cross over frequency.  
Selects the phase for the subwoofer.<sup>\*2</sup>  
Adjusts the subwoofer level.

<sup>\*1</sup> Adjustable only when the subwoofer is activated. (☞ page 40)

<sup>\*2</sup> Not selectable when <Freq> is set to <Through>.

# Changing the display design

You can change the background and panel color.

1 On <Top Menu>:



2

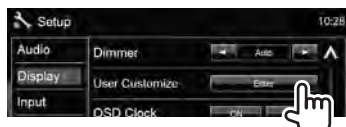
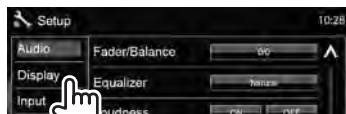

3 Select an item to change (<Background> or <Panel Color>).

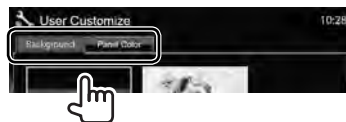

4 Select a background/panel color.

**To select a background**



For setting your favorite scene as the background, see page 36

**To select a panel color**

Variable color illumination

- Illumination color changes gradually.

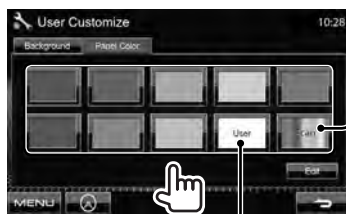

For making your own color adjustment, see below

**Making your own color adjustment**

- You can make your own color adjustment only when <User> is selected.

1



2



3

User color adjuster: You can make your own color adjustment stored in <User>

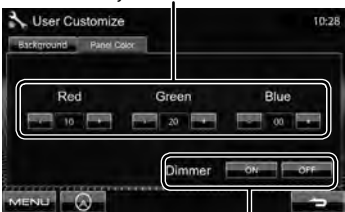

Dimmer setting: You can make the color adjustment for each dimmer setting

## Using your favorite scene as the background

While playing a video or JPEG, you can capture an image and use the captured image as a background.

- You cannot capture copyrighted content and images from iPod/iPhone.
- When using a JPEG file as the background, make sure that the resolution is 800 x 600 pixels.
- The color of the captured image may look different from that of the actual scene.

### 1 Play back a video or JPEG.

### 2 Display <User Customize>. (E3) page 35)

### 3



### 4 Adjust the image.



[▶||]\* Starts/Pauses playback.

[▶]\* Advances scenes frame-by-frame.

[🔍] Magnifies the scene.  
(<OFF>, <Zoom1> – <Zoom3>)

[▲] [▼] Moves the zooming frame.

[◀] [▶]

• To cancel the capture screen, press [Cancel].

\* Not displayed when playing an external component connected to AV-IN input terminal.

### 5 Capture the image displayed on the screen.



A confirmation message appears. Press [Yes] to store the newly captured image. (The existing image is replaced with the new one.)

• Press [No] to return to the previous screen.

# Setting for video playback

You can change the setting for video playback.

## Picture adjustment

You can adjust the picture quality.

### 1 Display the adjustment menu.

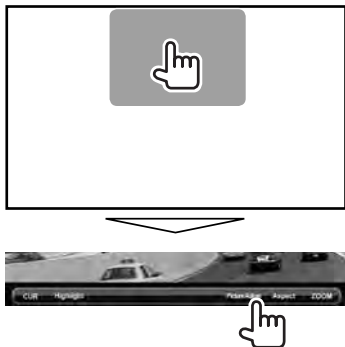

### 2 Select dimmer on (<DIM ON>) or off (<DIM OFF>).



### 3 Adjust the picture (-15 to +15).

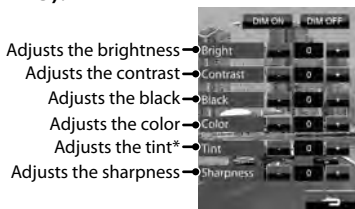

\* Adjustable only when the incoming signal is NTSC.

## Changing the aspect ratio

You can change the aspect ratio for video playback.

1



2



	4:3 signal	16:9 signal
<b>FULL*:</b> For 16:9 original pictures		
<b>JUST:</b> For 4:3LB original pictures		
<b>Normal*:</b> For 4:3 original pictures		
<b>Auto:</b>	<ul style="list-style-type: none"> <li>For "DISC"/"USB" only: Aspect ratio is automatically selected to match to the incoming signals.</li> </ul>	

\* While DivX is played back with <Screen Ratio> set to <16:9> (for disc: page 20/ for USB: page 22), the aspect ratio is not set correctly.

## Zooming picture

You can zoom the picture (<Zoom1> to <Zoom3>).

- When <Aspect> is set to <JUST> or <Auto> ( left column), the picture is zoomed with the aspect ratio of the <FULL> setting.

1



2



[▲] [▼] [◀] [▶]: Moves the zooming frame.

# Using a rear view camera

- To use a rear view camera, the REVERSE lead connection is required. For connecting a rear view camera, see page 71.

## ■ Activating the rear view camera

- 1 On <Top Menu>:



2

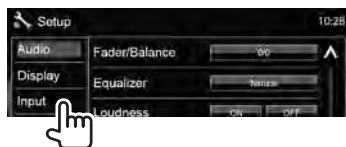

3



To deactivate, select <OFF>.

## ■ Displaying the picture from the rear view camera

The rear view screen is displayed when you shift the gear to the reverse (R) position.



- To erase the caution message, touch the screen.

To display the picture from the rear view camera manually

DDX6021BT/  
DDX6051BT

DDX4021BT/  
DDX4051BT/  
DDX3021/DDX3051

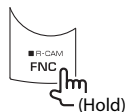

When displaying the picture from the rear view camera manually, you can change the setting of the picture. (see page 37)

To cancel the rear view screen, press and hold the same button again.

# Setting menu items



- You cannot change <Audio> settings when the unit is in standby.

Menu item	Selectable setting/item	Initial: <u>Underlined</u>
Audio	<b>Fader/Balance</b>	<p><b>Fader</b> : Adjust the front and rear speaker output balance.            ◆ <b>F6</b> to <b>R6</b>; Initial <b>0</b></p> <ul style="list-style-type: none"> <li>• When using a two-speaker system, set the fader to the center (<b>0</b>).</li> </ul> <p><b>Balance</b> : Adjust the left and right speaker output balance.            ◆ <b>L6</b> to <b>R6</b>; Initial <b>0</b></p> <p>Press [<b>▲</b>/<b>▼</b>/<b>◀</b>/<b>▶</b>] or drag [<b>+</b>] to adjust.            • To clear the adjustment, press [<b>Center</b>].</p>
	<b>Equalizer</b>	<p>Change the sound mode or adjust and store the equalization for each source. (ⓘ page 33)            ◆ <b>Natural/Rock/Pops/Easy/Top40/Jazz/User</b></p>
	<b>Loudness</b>	<p>You can activate/deactivate the loudness function.            ◆ <b>OFF</b> : Cancels.            ◆ <b>ON</b> : Boost low and high frequencies to produce a well-balanced sound at a low volume level. The LOUD indicator lights up.</p>
	<b>X'over</b>	Adjust the cross over frequency. (ⓘ page 34)
	<b>Volume Offset</b>	<p>Adjust and store the auto-adjustment volume level for each source. (For discs, the adjustment is stored for each of the following categories: DVD/DVD-VR, VCD/CD, and DivX/MPEG1/MPEG2/MP3/WMA/WAV/AAC.) The volume level will automatically increase or decrease when you change the source.            ◆ <b>-15</b> to <b>+6</b>; Initial <b>0</b></p>
	<b>Subwoofer</b>	<p>◆ <b>ON</b> : Activates the subwoofer.            ◆ <b>OFF</b> : Cancels.</p>
	<b>Speaker Select</b>	<p>Select the size of the connected speaker.            ◆ <b>Standard/Narrow/Middle/Wide</b></p>



Menu item	Selectable setting/item <span style="float: right;">Initial: <b><u>Underlined</u></b></span>
<b>Display</b>	<p>◆ <b><u>Auto</u></b> : Dims the screen and button illumination when you turn on the headlights.</p> <ul style="list-style-type: none"> <li>• The ILLUMI lead connection is required. (☞ page 69)</li> </ul> <p>◆ <b>ON</b> : Activates dimmer.</p> <p>◆ <b>OFF</b> : Cancels.</p> <p>◆ <b>NAV</b> : Activates or deactivates dimmer according to the day/night display setting of the connected navigation unit.</p>
	<p><b>User Customize</b> Change the display design (background and panel color). (☞ page 35)</p>
	<p><b>OSD Clock</b></p> <p>◆ <b>ON</b> : Displays the clock while a video source is played back.</p> <p>◆ <b>OFF</b> : Cancels.</p>
	<p><b>Scroll</b></p> <p>◆ <b>ON</b> : Repeats scrolling.</p> <p>◆ <b>Once</b> : Scrolls the displayed information once.</p> <p>◆ <b>OFF</b> : Cancels.</p> <ul style="list-style-type: none"> <li>• Pressing [<b>&lt;</b>] scrolls the text regardless of this setting.</li> </ul>
	<p><b>Menu Customize</b> Select the large buttons to be displayed on the &lt;<b>Top Menu</b>&gt; screen. Press [<b>Enter</b>] to display the setting screen. Select the icon you want to show as large button by pressing [<b>&lt;</b>] or [<b>&gt;</b>], then press the target icon to confirm.</p>
	<p><b>Screen Adjust</b> Adjust the brightness and black color of the screen. Select the dimmer mode (&lt;<b>DIM ON</b>&gt; or &lt;<b>DIM OFF</b>&gt;) for adjustment, then change the following settings:</p> <p>◆ <b>Bright</b> : Adjusts brightness (–<b>15</b> to <b>+15</b>; Initial <b>+15</b>).</p> <p>◆ <b>Black</b> : Adjusts black (–<b>15</b> to <b>+15</b>; Initial <b>0</b>).</p>
	<p><b>Video Output*</b> Select the color system of the external monitor.</p> <p>◆ <b><u>NTSC/PAL</u></b></p>
<p><b>Angle</b> Only for DDX6021BT/ DDX6051BT</p>	<p>Adjust the panel angle. (☞ page 5)</p>

\* "Please power off" appears when the setting is changed. Turn off the power, then turn on to enable the change.

Menu item		Selectable setting/item	Initial: <b><u>Underlined</u></b>
<b>Input</b>	<b>AV Input</b>	<p>You can determine the use of AV-IN input terminal.</p> <p>◆ <b>AV-IN2</b> : Select to play an AV component connected to the AV-IN input terminal.</p> <p>◆ <b><u>iPod</u></b> : Select when connecting the iPod/iPhone using the USB Audio and Video cable for iPod/iPhone. (☞ page 23)</p>	
	<b>R-CAM Interrupt</b>	<p>◆ <b>ON</b> : Displays the picture from the rear view camera when you shift the gear to the reverse (R) position.</p> <p>◆ <b><u>OFF</u></b> : Cancels.</p>	
	<b>Navigation</b>	Change the navigation settings. (☞ page 32)	

Menu item	Selectable setting/item	Initial: <b>Underlined</b>
<b>System</b>	<b>Language*</b>	<p>Select the text language used for on-screen information.</p> <p>◆ <b>English/Spanish/French/German/Italian/Dutch/Russian/Portuguese/Chinese-Simplified/Chinese-Traditional/Thai/Turkish/Arabic/Persian/Hebrew/Greece/Indonesia</b>; Initial for DDX6021BT/DDX4021BT/DDX3021: <b>English</b>, for DDX6051BT/DDX4051BT/DDX3051: <b>Russian</b></p> <ul style="list-style-type: none"> <li>For external monitors, only English/Spanish/French/German/Italian/Dutch/Russian/Portuguese are available. If another language has been selected, the text language for external monitors will be set to English.</li> </ul> <p>◆ <b>GUI Language</b> : Select a language (&lt;<b>English</b>&gt; or &lt;<b>Local</b>&gt;: the language selected above) used for displaying operation buttons and menu items.</p>
	<b>Clock</b>	Adjust the clock time. (☞ page 10)
	<b>Beep</b>	<p>◆ <b>ON</b> : Activates the key-touch tone.</p> <p>◆ <b>OFF</b> : Cancels.</p>
	<b>Remote Sensor</b>	<p>◆ <b>ON</b> : Activates the remote sensor.</p> <p>◆ <b>OFF</b> : Cancels.</p>
	<b>SETUP Memory</b>	You can memorize, recall, clear, or lock the settings you have made. (☞ page 44)
	<b>DivX(R) VOD</b>	<p>This unit has its own Registration Code. Once you have played back a file with which the Registration Code recorded, this unit's Registration Code is overwritten for copyright protection.</p> <ul style="list-style-type: none"> <li>Press [<b>Enter</b>] to display the information.</li> <li>To return to the previous screen, press [<b>OK</b>].</li> </ul>
	<b>Security Code</b>	Register the security code for the unit. (☞ page 7)
	<b>SI</b>	Activate or deactivate the security function. (☞ page 7)
	<b>Serial Number</b>	Displays the serial number.
	<b>Touch Panel Adjust</b>	Adjust the touch position of the buttons on screen. (☞ page 44)
	<b>System Information</b>	Displays the version information on the software. You can update the software. (☞ page 6)

\* "Please power off" appears when the setting is changed. Turn off the power, then turn on to enable the change.

## Memorizing/recalling the settings

You can memorize the settings changed in the <Setup> menu and recall the memorized settings anytime.

- The memorized settings are kept even when the unit is reset.

### 1 On <Setup>:



### 2



- To cancel, press [No].

### 3 Select an operation.



**[Recall]:** Recalls the memorized settings.

**[Memory]:** Memorizes the current settings.

**[Clear]:** Clears the currently memorized settings.

- To cancel, press [Cancel].

Confirmation message appears. Press [Yes].

## Locking the settings

You can lock the settings to prevent them from being changed.

-  is shown beside the settings that can be locked.

### 1 On <Setup>:



### 2

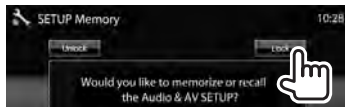

To unlock the setting, press [Unlock].

## Adjusting the touch position

You can adjust the touch position on the touch panel if the position touched and the operation performed do not match.

### 1 On <Setup>:



### 2 Touch the center of the marks at the lower left and at the upper right as instructed.



- To cancel the current operation, press [Cancel].
- To reset to the initial setting, press [Reset].

# BLUETOOTH OPERATIONS

(Only for DDX6021BT/DDX6051BT/DDX4021BT/DDX4051BT)

## Information for using Bluetooth® devices

- While driving, do not perform complicated operations such as dialing the numbers, using phonebook, etc. When you perform these operations, stop your car in a safe place.
- Some Bluetooth devices may not be connected to this unit depending on the Bluetooth version of the device.
- This unit may not work for some Bluetooth devices.
- Connecting condition may vary depending on circumstances around you.
- When the unit is turned off, the device is disconnected.

## Bluetooth operations



Bluetooth is a short-range wireless radio communication technology for the mobile device such as mobile phones, portable PCs, and other devices. The Bluetooth devices can be connected without cables and communicate with each other.

### Preparation:

Be sure to connect Bluetooth adapter KS-UBT1 (supplied) and microphone (supplied) beforehand. (☞ page 69)

### DDX6021BT/DDX6051BT

Bluetooth adaptor (KS-UBT1)

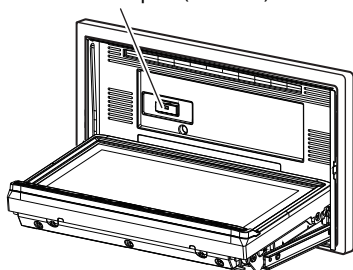

### DDX4021BT/DDX4051BT

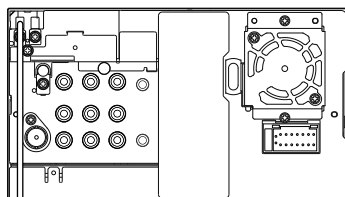

Bluetooth adaptor (KS-UBT1)

# Connecting Bluetooth devices

## ■ Connecting a new Bluetooth device for the first time

When you connect a Bluetooth device to the unit for the first time, make pairing between the unit and the device. Pairing allows Bluetooth devices to communicate each other.

To make pairing, you may need to enter the PIN (Personal Identification Number) code of your Bluetooth device you want to connect.

- Once the connection is established, it is registered in the unit even if you reset the unit. Up to 5 devices can be registered in total.
- Only one device for Bluetooth phone and one for Bluetooth audio can be connected at a time.
- To use the Bluetooth function, you need to turn on Bluetooth function of the device.
- The maximum digit of the PIN code that can be set is 16.

### 1 Display the Bluetooth setting screen.

On **<Top Menu>**:



### For connecting a Bluetooth mobile phone



**<Handsfree Mode>** is displayed.

### For connecting a Bluetooth audio player



**<Bluetooth Mode>** is displayed.

### 2 Change the PIN code.

- If you skip changing the PIN code, go to step 3.

#### On **<Handsfree Mode>**:

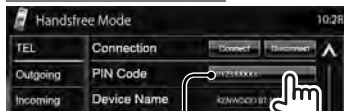

PIN code (initial: 0000)

#### On **<Bluetooth Mode>**:



PIN code (initial: 0000)

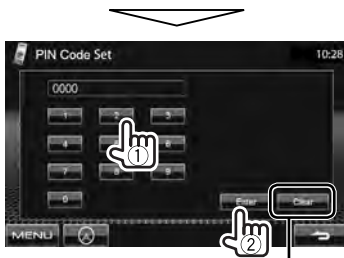

Deletes last character

3



4

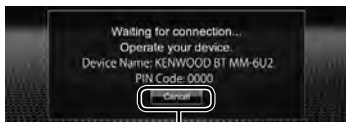

Cancel

## 5 Operate the Bluetooth device to connect.

"Connected" appears. Press [OK] to confirm the operation. Now connection is established and you can use the Bluetooth device through the unit.

## ■ Connecting/disconnecting a registered Bluetooth device

### 1 Display the Bluetooth setting screen. (☞ page 46)

- For Bluetooth mobile phone: <Handsfree Mode>
- For Bluetooth audio player: <Bluetooth Mode>

### 2 To connect



Select the device you want to connect.



- All registered devices (mobile phone and audio player) are listed on <Connect Device>.
  - Selectable items depend on the device you are operating.

### To disconnect



A confirmation message appears. Press [Yes].

## ■ Deleting a registered Bluetooth device

### 1 On <Connect Device> (☞ Step 2 on the left column):



### 2 Select a device to delete the registration.



Confirmation message appears. Press [Yes].

## Using the Bluetooth mobile phone

### ■ Receiving a call

When a call comes in...

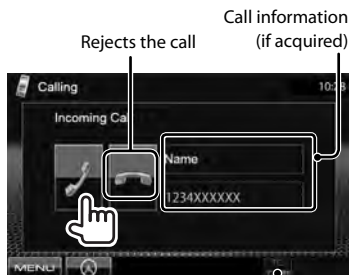

Status of the device/Battery reminder (only when the information comes from the device)

- Phone operation is not available while the picture from the rear view camera is displayed. (ESP page 39)

### When <Auto Response> is set to <On>

The unit answers the incoming call automatically. (ESP page 54)

### ■ Ending a call

While talking...



### ■ Adjusting the volume of microphone

While talking...





- This adjustment does not affect the volume level of the other sources.
- To adjust the volume of calls/earpiece, use the volume knob on the monitor panel.

### ■ Switching between handsfree mode and phone mode

While talking...



Each time you press the button, the talking method is switched (  : handsfree mode /  : phone mode).

### ■ Checking SMS reception

If the mobile phone is compatible with SMS (Short Message Service), the unit tells you a message has been received.

To read a received message, operate the mobile phone after stopping the car in a safe place.

- You cannot read, edit, or send a message through the unit.



## ■ Making a call

### 1 On <Top Menu>:

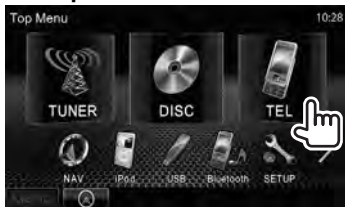

### 2 Select a method to make a call.

Phonebook/Call lists (☞ page 50)

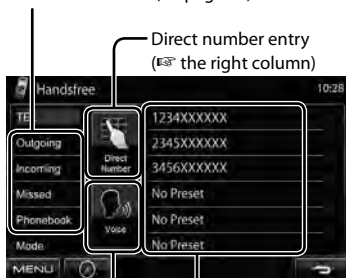

Direct number entry  
(☞ the right column)

Preset list (For presetting,  
☞ page 51)

Voice dialing (☞ the right column)

### Direct number entry

Deletes last character



Hold: Adds "+"

Presets the entered phone number on the preset list (☞ page 51)

- You can enter up to 32 numbers.

### Voice Dialing

- Available only when the connected mobile phone has the voice recognition system.



Speak the name you want to call.

**To cancel**, press [Cancel].

## Using the phonebook/call lists

1



<b>Outgoing</b>	From dialled call list.
<b>Incoming</b>	From received call list.
<b>Missed</b>	From missed call list.
<b>Phonebook</b>	From phonebook. <ul style="list-style-type: none"><li>For copying the phonebook, see page 51.</li></ul>



2



### To use the A-Z search on the phonebook

When <Phonebook> is selected, you can search by initial.

1

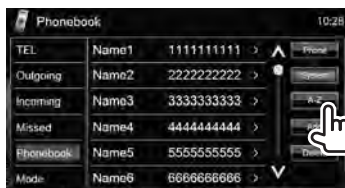

2 Select the initial. If the initial is not a letter or number, press [Others].



3 Select a phone number from the list.



### To display the details of an entry

When <Phonebook> is selected...

1 Press the right arrow icon of an entry.



2 To make a call, select a phone number.

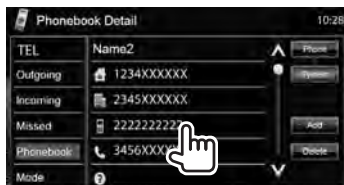

## ■ Presetting the phone numbers

You can preset up to 6 phone numbers.

### 1 On <Top Menu>:



### 2 Select an item from phonebook/call lists.



### 3 Select a phone number.

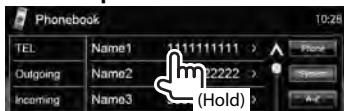

### 4 Select a preset number to store.



- You can also preset the phone number entered on <Direct Number> screen by pressing [Preset]. (see page 49)

**To delete the preset phone numbers,** initialize the settings from <Initialize> in <Handsfree Mode>. (see page 54)

## ■ Copying the phonebook

You can copy the phonebook memory of a mobile phone into the unit (up to 400 entries).

### 1 On <Top Menu>:



### 2



### 3

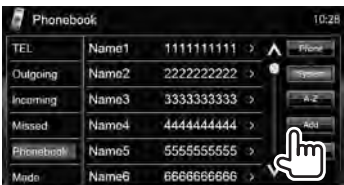

PIN code (initial: 0000)

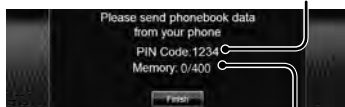

Numbers of the phonebook entries copied

### 4 Operate the target mobile phone.

- Refer to the instruction manual supplied with your mobile phone.
- **To cancel the transfer,** press [Finish].

### 5 Finish the procedure.



The phonebook memory is copied from the mobile phone.

## ■ Deleting the phone number entries in the unit

- 1 Display the phonebook/call list you want to delete. (See page 50)
- 2

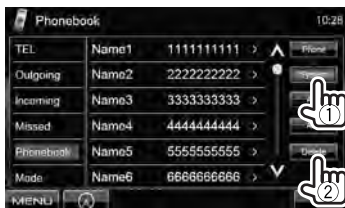

- You cannot delete data when <Phone> is selected.

- 3 Select the item you want to delete.



Delete all the numbers/  
names in the selected item

A confirmation message appears. Press [Yes].

## ■ About mobile phones compatible with Phone Book Access Profile (PBAP)

If your mobile phone supports PBAP, the phonebook and call lists are automatically copied to the unit when the mobile phone is connected.

- Phonebook: up to 5 000 entries
- Dialed calls, received calls, and missed calls: up to 50 entries each

### To display the phonebook/call lists of the mobile phone or the unit

Connected mobile phone



Unit

## Using the Bluetooth audio player

- To register a new device, see page 46.
- To connect/disconnect a device, see page 47.



- Tag data (current track title/  
artist name/album title)\*
- Pressing [**<**] scrolls the text if not all of the text is shown.
- Playing time\*
- Playback status\*  
(▶: play/||: pause)

see page 32

Battery reminder (only when the information comes from the device)

- The operation buttons, indications and information displayed on the screen differ depending on the connected device.

[▶]	Starts playback.
[  ]	Pauses.
[◀◀▶▶]	<ul style="list-style-type: none"> <li>• Selects track. (Press)</li> <li>• Reverse/forward search* (Hold)</li> </ul>

[Mode]	Displays the Bluetooth setting screen. (see below)
[MENU]	Displays <Top Menu> screen.

\* Available only for the devices compatible with AVRCP 1.3.

## Bluetooth device settings

**For Bluetooth mobile phone:**

1 On <Top Menu>:



2





**For Bluetooth audio player:**

1 On <Top Menu>:



2



Menu items	Selectable setting/item	Initial: <b><u>Underlined</u></b>
Connection	<ul style="list-style-type: none"> <li>◆ <b>Connect</b> :  page 47</li> <li>◆ <b>Disconnect</b> :  page 47</li> </ul>	
PIN Code	Changes the PIN code of the unit. <ul style="list-style-type: none"> <li>• Enter a new PIN code, then press <b>[Enter]</b>.</li> </ul>	
Device Name	Shows the device name to be shown on the Bluetooth device — “KENWOOD BT MM-6U2.”	
Device Address	Shows the device address of the unit.	
Phone Device*1	Shows the connected phone device name.	
Audio Device*2	Shows the connected audio device name.	
Auto Connect	<ul style="list-style-type: none"> <li>◆ <b>OFF</b> : Cancels.</li> <li>◆ <b>ON</b> : The connection is automatically established with the last connected Bluetooth device when the unit is turned on.</li> </ul>	
Bluetooth HF/Audio	Select the speakers used for Bluetooth (both phone use and audio player). <ul style="list-style-type: none"> <li>◆ <b>Front Only</b> : From front speakers only.</li> <li>◆ <b>All</b> : From all speakers.</li> </ul>	
Initialize	Hold <b>[Enter]</b> to initialize all settings you have made for using Bluetooth mobile phone and Bluetooth audio player.	
Auto Response*1	<ul style="list-style-type: none"> <li>◆ <b>OFF</b> : The unit does not answer the calls automatically. Answer the calls manually.</li> <li>◆ <b>ON</b> : The unit answers the incoming calls automatically within 5 seconds.</li> </ul>	
SMS Notify*1	<ul style="list-style-type: none"> <li>◆ <b>OFF</b> : The unit does not inform you of the arrival of a message.</li> <li>◆ <b>ON</b> : The unit informs you of the arrival of a message by ringing and displaying “Receiving Message.”</li> </ul>	
Ring Mode*1	<ul style="list-style-type: none"> <li>◆ <b>System</b> : Selects the ring tone set on the unit.</li> <li>◆ <b>Phone</b> : Selects the ring tone set on the mobile phone. (This function may not work depending on the mobile phone.)</li> </ul>	
Ring Tone Change*1	When <Ring Mode> is set to <System>, press <b>[Enter]</b> , then select the ring tone for received calls and SMS from <Tone1>, <Tone2>, <Tone3>. <ul style="list-style-type: none"> <li>◆ <b>Call Tone</b> : Selects the ring tone for phone calls.</li> <li>◆ <b>Message Tone</b> : Selects the ring tone for SMS.</li> </ul>	

\*1 Appears only for <Handsfree Mode>.

\*2 Appears only for <Bluetooth Mode>.

# USING THE REMOTE CONTROLLER

## Overview

DDX6021BT/DDX6051BT:

This unit can be operated using the Remote Controller (RC-DV340) supplied with this unit.  
DDX4021BT/DDX4051BT/DDX3021/DDX3051:

Optional Remote Controller KNA-RCDV331 is designed for controlling this unit. Refer to the instruction manual that comes with the remote controller.

### ⚠ CAUTION

- Put the Remote Controller in a place where it will not move during braking or other operations. A dangerous situation could result, if the Remote Controller falls down and gets wedged under the pedals while driving.
- Do not leave the battery near fire or under direct sunlight. A fire, explosion or excessive heat generation may result.
- Do not recharge, short, break up or heat the battery or place it in an open fire. Such actions may cause the battery to leak fluid. If spilled fluid comes in contact with your eyes or on clothing, immediately rinse with water and consult a physician.
- Place the battery out of reach of children. In the unlikely event that a child swallows the battery, immediately consult a physician.

### Battery installation

Use two "AAA"/"R03"-size batteries. Insert the batteries with the + and – poles aligned properly, following the illustration inside the case.

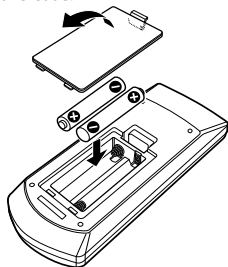

- If the Remote Controller operates only over shorter distances or does not operate at all, it is possible that the batteries are depleted. In such instances, replace the both batteries with new ones.

### Remote Controller mode switch

The functions operated from the remote controller differ depending on the position of the mode switch.

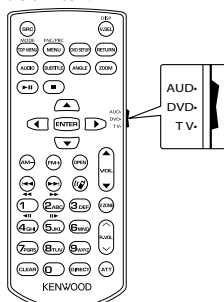

**AUD mode:** Switch to this mode when controlling a selected source or tuner source, etc.

**DVD mode:** Switch to this mode when playing DVDs or CDs etc. with the player integrated in this unit.

**TV mode:** Not used.

- The position of the remote control mode switch is indicated in the title of each mode, e.g., "(AUD mode)".
- When controlling a player that is not integrated in the unit, select "AUD" mode.

# Operations from the remote controller

## Common operations (AUD mode)

### Source switching

Switches to the source to be played.  
Hangs up the incoming/current call.

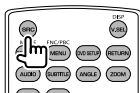

### Volume control

Adjusts the volume.

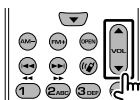

### Volume attenuating

Press the key once to lower the volume. Press again to restore the previous volume.

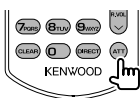

### NAV/V.SEL

Switches to the navigation screen.

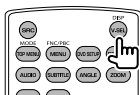

### Cursor key

Moves the cursor when displaying menu.

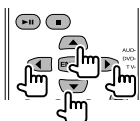

## ENTER

Enters options.

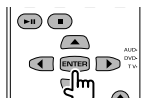

## Hands-free communication

When a call comes in, it answers the call.

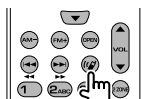

## Function

Switches the function screen.

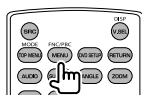

## MODE

Switches the screen mode.

Screen mode changes each time you press this key.

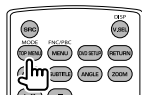

## OPEN

Adjusts the panel angle.

The panel angle changes each time you press this key.

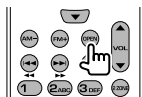



## DVD/VCD (DVD mode)

### Track search and file search

Selects the track or file to be played.

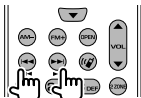

### Play/Pause

Pauses the track.

Press again to resume playing.



### Stop

Memorizes the last point where the disc stopped.



### Direct search

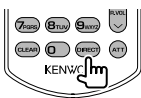

Pressing this key switches the features that can be searched directly.

### DVD-VIDEO

Chapter number

Title number

Cancel

### DVD-VR

Chapter number

Program/Playlist

Cancel

## VCD 1.X, VCD 2.X (PBC OFF)

Track number

Cancel

## VCD 2.X (PBC ON)

Track number

Cancel

Once you have switched to the direct search feature, specify the search number from the numeric keypad, and then press **[ENTER]** key.

### Numeric keypad

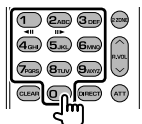

- Specify the number to search in direct search.
- Press **1** **2**ABC to fast forward/backward. Switches the fast forward/backward speed each time you press this key.
- Press **1** **2**ABC to slow forward/backward during pause.

### DVD Top Menu

Returns to the DVD top menu.

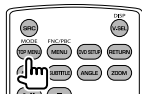

### DVD Menu

Displays the DVD menu.

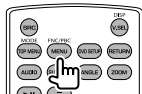

## SUBTITLE

Switches the subtitle language.

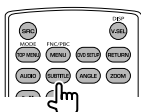

## ZOOM

Switches the zoom ratio each time you press this key.

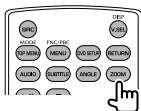

## Picture Angle

Switches the picture angle each time you press this key.

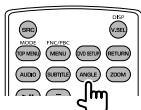

## AUDIO

Switches Voice Language.  
Switches the voice language each time you press this key.

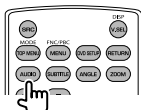

## Music Disc/Audio file/Video file/ Picture file (AUD mode)

### Folder search

Selects the folder to be played.

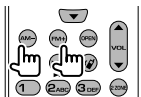

## Track search and file search

Selects the track or file to be played.



## Play/Pause

Pauses the track.  
Press again to resume playing.



## Direct search

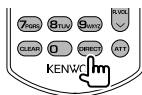

Pressing this key switches the features that can be searched directly.

## Music Disc

Track number

Cancel

## Audio files in DVD/CD disc

Folder number

File number

Cancel

Once you have switched to the direct search feature, specify the search number from the numeric keypad, and then press [ENTER] key.

## Numeric keypad

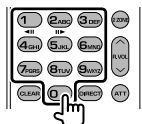

- Specify the number to search in direct search.

## Radio (AUD mode)

### Band switching

Switches to bands received by the unit.

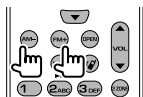

### Station selection

Switches to broadcast stations received by the unit.

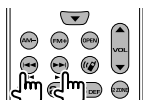

### Seek mode switching

Switches the Seek mode (AUTO1, AUTO2, MANU).



### Direct tuning

After pressing this key, use the keypad to specify the broadcast station you wish to receive.

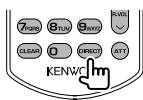

Example: 92.1MHz (FM)

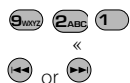

Example: 810kHz (AM)

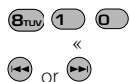

### Numeric keypad

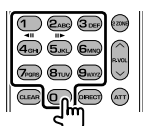

- To use preset tuning, press the number of a programmed broadcast station. (1 - 6 BAND)
- Press the direct tuning key first, then specify the frequency of the station to receive.

## iPod (AUD mode)

### Music/Video search

Selects the music/video to be played.

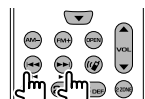

### Play/Pause

Pauses the music/video.

Press again to resume playing.



## USB (AUD mode)

### Folder search

Selects the folder to be played.



### File search

Selects the file to be played.



### Play/Pause

Pauses the file.

Press again to resume playing.



# REFERENCE

## Maintenance

### Caution on cleaning the unit

Do not use any solvent (for example, thinner, benzene, etc.), detergent, or insecticide. This may damage the monitor or the unit.

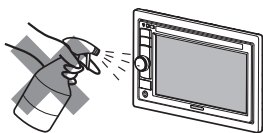

#### Recommended cleaning method:

Gently wipe the panel with a soft, dry cloth.

### Moisture condensation

Moisture may condense on the lens inside the unit in the following cases:

- After starting the heater in the car.
  - If it becomes very humid inside the car.
- Should this occur, the unit may malfunction. In this case, eject the disc and leave the unit turned on for a few hours until the moisture evaporates.

### How to handle discs

**When removing a disc from its case,** press down the center holder of the case and lift the disc out, holding it by the edges.

Center holder



- Always hold the disc by the edges. Do not touch its recording surface.

**When storing a disc in its case,** gently insert the disc around the center holder (with the printed surface facing up).

- Make sure to store discs in their cases after use.

### To keep discs clean

A dirty disc may not play correctly. If a disc does become dirty, wipe it with a soft cloth in a straight line from center to edge.



- Do not use any solvents (for example, conventional record cleaner, spray, thinner, benzene, etc.) to clean discs.

### To play new discs

New discs may have some rough spots around the inner and outer edges. If such a disc is used, this unit may reject the disc.



**To remove these rough spots,** rub the edges with a pencil or ball-point pen, etc.

#### Do not use the following discs:

8 cm CD



Warped disc



Sticker and sticker residue



Stick-on label



Unusual shape



C-thru Disc (semi-transparent disc)



Transparent or semi-transparent parts on its recording area



# More about this unit

## ■ File playback

### Playing DivX files

- This unit can play back DivX files with the extension code <.divx>, <.div>, or <.avi> (regardless of the letter case—upper/lower).
- Audio stream should conform to MP3 or Dolby Digital.
- The file encoded in the interlaced scanning mode may not be played back correctly.

### Playing MPEG1/MPEG2 files

- This unit can play back MPEG1/MPEG2 files with the extension code <.mpg>, <.mpeg>, or <.mod>.
- The stream format should conform to MPEG system/program stream. The file format should be MP@ML (Main Profile at Main Level)/SP@ML (Simple Profile at Main Level)/MP@LL (Main Profile at Low Level).
- Audio streams should conform to MPEG1 Audio Layer-2 or Dolby Digital.

### Playing JPEG files

- This unit can play back JPEG files with the extension code <.jpg>, or <.jpeg>.
- This unit can play back JPEG files that are at 32 x 32 to 8 192 x 7 680 resolution. It may take time to display the file depending on its resolution.
- This unit can play back baseline JPEG files. Progressive JPEG files or lossless JPEG files cannot be played.

**We bear no responsibility for any loss of data in an iPod/iPhone and USB mass storage class device while using this unit.**

### Playing MP3/WMA/WAV/AAC files

- This unit can play back files with the extension code <.mp3>, <.wma>, <.wav>, or <m4a> (regardless of the letter case—upper/lower).
- This unit can play back the files meeting the conditions below:
  - Bit rate:
    - MP3/WMA: 32 kbps — 320 kbps
    - AAC: 16 kbps — 320 kbps
  - Sampling frequency:
    - 48 kHz, 44.1 kHz, 32 kHz (for MPEG1)
    - 24 kHz, 22.05 kHz, 16 kHz (for MPEG2)
    - 48 kHz, 44.1 kHz, 32 kHz, 22.05 kHz (for WMA)
    - 44.1 kHz (for WAV)
    - 48 kHz, 44.1 kHz (for AAC)
- This unit can show ID3 Tag Version 1.0/1.1/2.2/2.3/2.4 (for MP3).
- This unit can also show WAV/WMA Tag.
- This unit can play back files recorded in VBR (variable bit rate).
- Files recorded in VBR have a discrepancy in elapsed time indication.
- This unit cannot play back the following files:
  - MP3 files encoded with MP3i and MP3 PRO format.
  - MP3 files encoded with Layer 1/2.
  - WMA files encoded with lossless, professional, and voice format.
  - WMA files which are not based upon Windows Media® Audio.
  - WMA/AAC files copy-protected with DRM.
  - AAC files encoded by using any other application than iTunes.
  - AAC files copy-protected with FairPlay (except those stored on an iPod).
  - Files which have the data such as AIFF, ATRAC3, etc.

## ■ Sound signals emitted through the rear terminals

### *Through the analog terminals (Speaker out/Front Preout/Rear Preout)*

2-channel signal is emitted. When playing multi-channel encoded disc, multi-channel signals are downmixed.

## ■ Language codes (for DVD/DivX language selection)

Code	Language	Code	Language	Code	Language	Code	Language
AA	Afar	GL	Galician	MI	Maori	SO	Somali
AB	Abkhazian	GN	Guarani	MK	Macedonian	SQ	Albanian
AF	Afrikaans	GU	Gujarati	ML	Malayalam	SR	Serbian
AM	Ameharic	HA	Hausa	MN	Mongolian	SS	Siswati
AR	Arabic	HI	Hindi	MO	Moldavian	ST	Sesotho
AS	Assamese	HR	Croatian	MR	Marathi	SU	Sundanese
AY	Aymara	HU	Hungarian	MS	Malay (MAY)	SW	Swahili
AZ	Azerbaijani	HY	Armenian	MT	Maltese	TA	Tamil
BA	Bashkir	IA	Interlingua	MY	Burmese	TE	Telugu
BE	Byelorussian	IE	Interlingue	NA	Nauru	TG	Tajik
BG	Bulgarian	IK	Inupiak	NE	Nepali	TH	Thai
BH	Bihari	IN	Indonesian	NO	Norwegian	TI	Tigrinya
BI	Bislama	IS	Icelandic	OC	Occitan	TK	Turkmen
BN	Bengali, Bangla	IW	Hebrew	OM	(Afan) Oromo	TL	Tagalog
BO	Tibetan	JA	Japanese	OR	Oriya	TN	Setswana
BR	Breton	JL	Yiddish	PA	Panjabi	TO	Tonga
CA	Catalan	JW	Javanese	PL	Polish	TR	Turkish
CO	Corsican	KA	Georgian	PS	Pashto, Pushto	TS	Tsonga
CS	Czech	KK	Kazakh	QU	Quechua	TT	Tatar
CY	Welsh	KL	Greenlandic	RM	Rhaeto-Romance	TW	Twi
DZ	Bhutani	KM	Cambodian	RN	Kirundi	UK	Ukrainian
EL	Greek	KN	Kannada	RO	Rumanian	UR	Urdu
EO	Esperanto	KO	Korean (KOR)	RW	Kinyarwanda	UZ	Uzbek
ET	Estonian	KS	Kashmiri	SA	Sanskrit	VI	Vietnamese
EU	Basque	KU	Kurdish	SD	Sindhi	VO	Volapuk
FA	Persian	KY	Kirghiz	SG	Sangho	WO	Wolof
FI	Finnish	LA	Latin	SH	Serbo-Croatian	XH	Xhosa
FJ	Fiji	LN	Lingala	SI	Singhalese	YO	Yoruba
FO	Faroese	LO	Laothian	SK	Slovak	ZU	Zulu
FY	Frisian	LT	Lithuanian	SL	Slovenian		
GA	Irish	LV	Latvian, Lettish	SM	Samoaan		
GD	Scots Gaelic	MG	Malagasy	SN	Shona		

# Troubleshooting

What appears to be trouble is not always serious. Check the following points before calling a service center.

- For operations with the external components, refer also to the instructions supplied with the adapters used for the connections (as well as the instructions supplied with the external components).

## ■ If the following messages appear

Message	Remedy/Cause
"No Signal"	<ul style="list-style-type: none"><li>• Start the playback on the external component connected to AV-IN input terminal.</li><li>• Check the cords and connections.</li><li>• Signal input is too weak.</li></ul>
<ul style="list-style-type: none"><li>• "Miswiring DC Offset Error"</li><li>• "Warning DC Offset Error"</li></ul>	A speaker cord has shorted or it has come in to contact with the car chassis. Wire or insulate the speaker cord as appropriate, then reset the unit (☞ page 3, 69).
"Parking off"	No playback picture is shown when the parking brake is not engaged.
"Authorization Error"	Check whether the connected iPod/iPhone is compatible with this unit. (☞ page 23)
"USB Device Error"	<ul style="list-style-type: none"><li>• The USB power voltage is abnormal.</li><li>• Turn off and turn on the unit.</li><li>• Connect another USB device.</li></ul>
"No BT Dongle"	Bluetooth adapter (KS-UBT1) is removed.
"Connection Error"	The device is registered but the connection has failed. Connect the registered device. (☞ page 47)
"Please Wait..."	The unit is preparing to use the Bluetooth function. If the message does not disappear, turn off and turn on the unit, then connect the device again (or reset the unit).
"NO Voice Device"	The connected mobile phone does not have the voice recognition system.
"NO Data"	No phonebook data is contained in the connected Bluetooth phone.
"Initialize Error"	The unit has failed to initialize the Bluetooth module. Try the operation again.
"Dial Error"	Dialing has failed. Try the operation again.
"Hung Up Error"	The call has not ended yet. Park your car, and use the connected mobile phone to end the call.
"Pick Up Error"	The unit has failed to receive a call.
"Pairing Mode Error"	Pairing between the unit and Bluetooth device has failed. Register the device again. (☞ page 46)
"Panel Mecha Error"	The panel does not work properly. Reset the unit.
"No Navigation"	No navigation unit is connected.

## ■ If there seems to be a problem

	Symptom	Remedy/Cause
<b>General</b>	No sound comes out of the speakers.	<ul style="list-style-type: none"> <li>Adjust the volume to the optimum level.</li> <li>Check the cords and connections.</li> </ul>
	No picture is displayed on the screen.	Turn on the screen. (☞ page 11)
	The unit does not work at all.	Reset the unit. (☞ page 3)
	The remote controller* does not work.	Replace the battery.
<b>TUNER</b>	AME automatic presetting does not work.	Store stations manually. (☞ page 27)
	Static noise while listening to the radio.	Connect the aerial firmly.
<b>Disc in general</b>	<ul style="list-style-type: none"> <li>Recordable/Rewritable discs cannot be played back.</li> <li>Tracks on the Recordable/Rewritable discs cannot be skipped.</li> </ul>	<ul style="list-style-type: none"> <li>Insert a finalized disc.</li> <li>Finalize the discs with the component which you used for recording.</li> </ul>
	Playback does not start.	The format of files is not supported by the unit.
	No picture appears on the external monitor.	<ul style="list-style-type: none"> <li>Connect the video cord correctly.</li> <li>Select the correct input on the external monitor.</li> </ul>
<b>DivX/MPEG1/MPEG2/JPEG/MP3/WMA/WAV/AAC</b>	Disc cannot be played back.	<ul style="list-style-type: none"> <li>Record the tracks using a compliant application on the appropriate discs. (☞ page 15)</li> <li>Add appropriate extension codes to the file names.</li> </ul>
	Tracks are not played back as you have intended them to play.	Playback order may differ from the one played back using other players.
<b>AV-IN</b>	No picture appears on the screen.	<ul style="list-style-type: none"> <li>Turn on the video component if it is not on.</li> <li>Connect the video component correctly.</li> </ul>

\* For DDX4021BT/DDX4051BT/DDX3021/DDX3051, purchase KNA-RCDV331 separately.



	Symptom	Remedy/Cause
iPod/iPhone	No sound comes out of the speakers.	<ul style="list-style-type: none"> <li>• Disconnect the iPod, then connect it again.</li> <li>• Select another source and then reselect "<b>iPod</b>".</li> </ul>
	The iPod/iPhone does not turn on or does not work.	<ul style="list-style-type: none"> <li>• Check the connecting cable and its connection.</li> <li>• Update the firmware version.</li> <li>• Charge the battery.</li> <li>• Check whether the iPod control mode is correctly selected. (☞ page 25)</li> <li>• Reset the iPod/iPhone.</li> </ul>
	Sound is distorted.	Deactivate the equalizer either on this unit or the iPod/iPhone.
	A lot of noise is generated.	Turn off (uncheck) the "VoiceOver" feature of the iPod. For details, visit < <a href="http://www.apple.com">http://www.apple.com</a> >.
	No operations are available when playing back a track containing Artwork.	Operate the unit after the Artwork is loaded. (☞ page 23)
	Sound does not synchronize with the video.	Select < <b>iPod</b> > for < <b>AV Input</b> >. (☞ page 42)
USB	<ul style="list-style-type: none"> <li>• Videos cannot be played.</li> <li>• No sound of videos comes out.</li> </ul>	<ul style="list-style-type: none"> <li>• Connect USB Audio and Video cable KCA-iP202/ KCA-iP22F. Other cables cannot be used.</li> <li>• Select &lt;<b>iPod</b>&gt; for &lt;<b>AV Input</b>&gt;. (☞ page 42)</li> </ul>
	"Reading..." keeps flashing on the screen.	Turn off the power and on again.
	While playing a track, sound is sometimes interrupted.	The tracks are not properly copied into the USB device. Copy tracks again, and try again.

	Symptom	Remedy/Cause
<b>Bluetooth (only for DDX6021BT/DDX6051BT/DDX4021BT/DDX4051BT)</b>	Phone sound quality is poor.	<ul style="list-style-type: none"> <li>• Reduce the distance between the unit and the Bluetooth mobile phone.</li> <li>• Move the car to place where you can get a better signal reception.</li> </ul>
	The sound is interrupted or skipped while using a Bluetooth audio player.	<ul style="list-style-type: none"> <li>• Reduce the distance between the unit and the Bluetooth audio player.</li> <li>• Disconnect the device connected for Bluetooth phone.</li> <li>• Turn off, then turn on the unit.</li> <li>• (When the sound is not yet restored) connect the player again.</li> </ul>
	The connected audio player cannot be controlled.	Check whether the connected audio player supports AVRCP (Audio Video Remote Control Profile).
	Bluetooth device does not detect the unit.	<ul style="list-style-type: none"> <li>• Check whether the Bluetooth adapter (KS-UBT1) is inserted correctly.</li> <li>• Search from the Bluetooth device again.</li> </ul>
	The unit does not make pairing with the Bluetooth device.	Enter the same PIN code for both the unit and target device. If the PIN code of the device is not indicated on its instructions, try "0000" or "1234."
	Echo or noise occurs.	Adjust the microphone unit position.
	The unit does not respond when you try to copy the phonebook to the unit.	You may have tried to copy the same entries (as stored) to the unit.

# Accessories/Installation Procedure

## Accessories

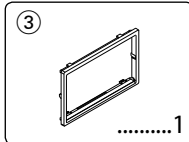
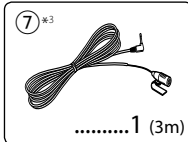
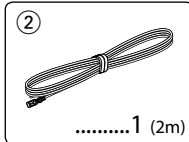
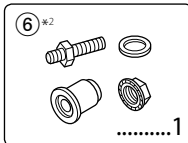
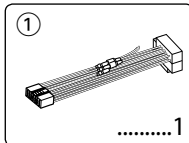

\*1 DDX4021BT/  
DDX4051BT/DDX3021/  
DDX3051 only.

\*2 DDX6021BT/  
DDX6051BT only.

\*3 DDX6021BT/  
DDX6051BT/  
DDX4021BT/  
DDX4051BT only.

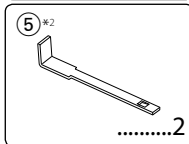
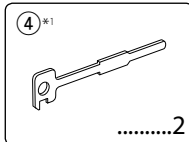

6 Connect the wiring harness connector to the unit.

7 Install the unit in your car.

8 Reconnect the  $\ominus$  battery.

9 Press the reset button.

10 Perform the Initial Setup.

## ⚠ WARNING

- If you connect the ignition wire (red) and the battery wire (yellow) to the car chassis (ground), you may cause a short circuit, that in turn may start a fire. Always connect those wires to the power source running through the fuse box.
- Do not cut out the fuse from the ignition wire (red) and the battery wire (yellow). The power supply must be connected to the wires via the fuse.

## After the Installation

After the installation, perform the Initial Setup by referring to the instruction manual.



- Mounting and wiring this product requires skills and experience. For best safety, leave the mounting and wiring work to professionals.
- Make sure to ground the unit to a negative 12V DC power supply.
- Do not install the unit in a spot exposed to direct sunlight or excessive heat or humidity. Also avoid places with too much dust or the possibility of water splashing.
- Do not use your own screws. Use only the screws provided. If you use the wrong screws, you could damage the unit.
- If the power is not turned ON ("Miswiring DC Offset Error", "Warning DC Offset Error" is displayed), the speaker wire may have a short-circuit or touched the chassis of the vehicle and the protection function may have been activated. Therefore, the speaker wire should be checked.
- If your car's ignition does not have an ACC position, connect the ignition wires to a power source that can be turned on and off with the ignition key. If you connect the ignition wire to a power source with a constant voltage supply, such as with battery wires, the battery may be drained.
- If the console has a lid, make sure to install the unit so that the faceplate will not hit the lid when closing and opening.

## Installation Procedure

- 1 To prevent a short circuit, remove the key from the ignition and disconnect the  $\ominus$  battery.
- 2 Make the proper input and output wire connections for each unit.
- 3 Connect the speaker wires of the wiring harness.
- 4 Take Connector B on the wiring harness and connect it to the speaker connector in your vehicle.
- 5 Take Connector A on the wiring harness and connect it to the external power connector on your vehicle.

- If the fuse blows, first make sure the wires aren't touching to cause a short circuit, then replace the old fuse with one with the same rating.
- Insulate unconnected wires with vinyl tape or other similar material. To prevent a short circuit, do not remove the caps on the ends of the unconnected wires or the terminals.
- Connect the speaker wires correctly to the terminals to which they correspond. The unit may be damaged or fail to work if you share the ⊖ wires or ground them to any metal part in the car.
- When only two speakers are being connected to the system, connect the connectors either to both the front output terminals or to both the rear output terminals (do not mix front and rear). For example, if you connect the ⊕ connector of the left speaker to a front output terminal, do not connect the ⊖ connector to a rear output terminal.
- After the unit is installed, check whether the brake lamps, blinkers, wipers, etc. on the car are working properly.
- Mount the unit so that the mounting angle is 30° or less.
- Do not press hard on the panel surface when installing the unit to the vehicle. Otherwise scars, damage, or failure may result.
- This unit has the cooling fan to decrease the internal temperature. Do not mount the unit in a place where the cooling fan of the unit are blocked. Blocking these openings will inhibit the cooling of the internal temperature and result in malfunction.

Cooling fan

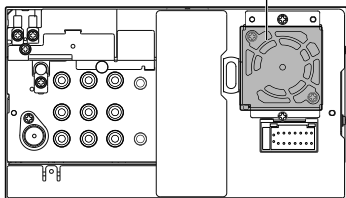

**CAUTION**

Install this unit in the console of your vehicle.  
Do not touch the metal part of this unit during and shortly after the use of the unit. Metal part such as the heat sink and enclosure become hot.

**DDX6021BT/ DDX6051BT only**

1 Before installation, remove the screws.

Do not use the removed screws for installation.

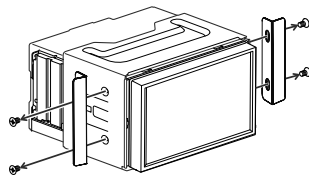

2 Detach the sleeve using the two removal tools ⑤ then slide off the sleeve.

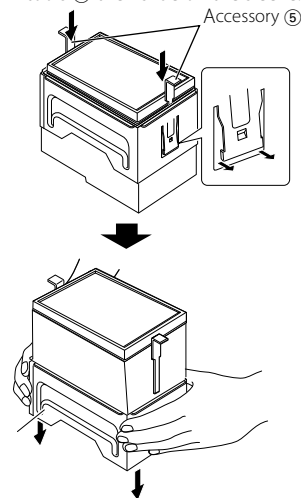

**DDX4021BT/ DDX4051BT only**

- Install the Bluetooth adaptor (KS-UBT1) besides the place enclosed by the metal.

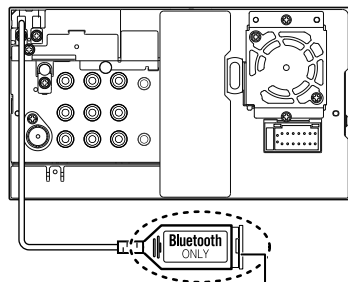

Bluetooth adaptor (KS-UBT1)

# Connecting Wires to Terminals

Bluetooth Microphone (Accessory ⑦)  
DDX6021BT/DDX6051BT/  
DDX4021BT/DDX4051BT only

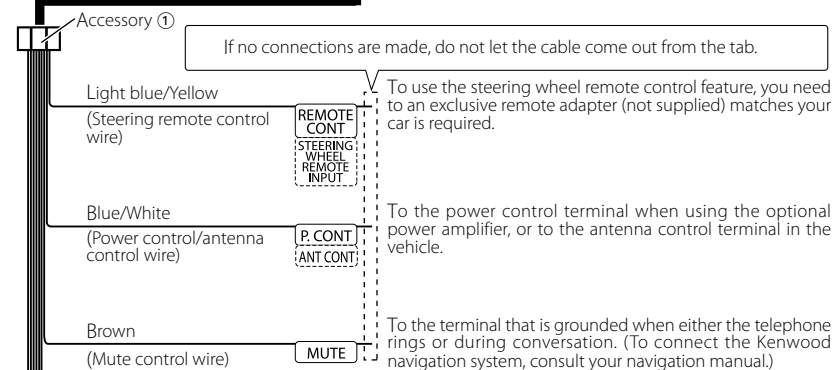
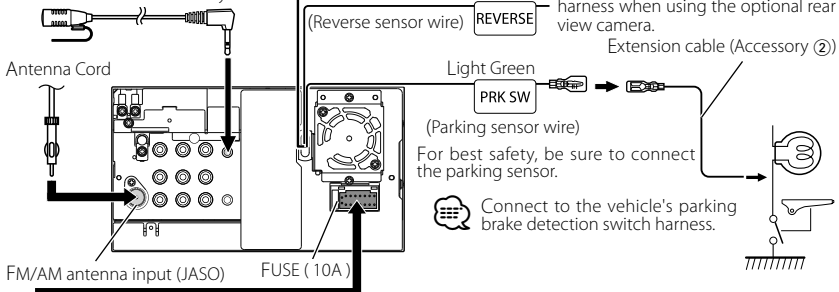

## Connecting the ISO connectors on some VW/Audi or Opel (Vauxhall) automobiles

You may need to modify the wiring of the supplied wiring harness as illustrated below.

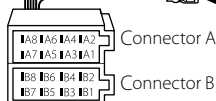
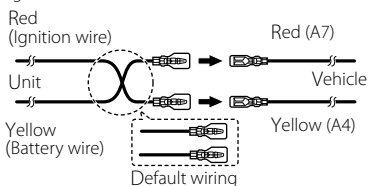

Pin	Colour and functions	Pin	Colour and functions
A4	Yellow Battery	B1/B2	Purple⊕ / Purple/Black⊖ Rear Speaker (Right)
A5	Blue/White Power Control	B3/B4	Gray⊕ / Gray/Black⊖ Front Speaker (Right)
A6	Orange/White Dimmer	B5/B6	White⊕ / White/Black⊖ Front Speaker (Left)
A7	Red Ignition (ACC)	B7/B8	Green⊕ / Green/Black⊖ Rear Speaker (Left)
A8	Black Earth (Ground) Connection		

# Connecting a USB device/iPod/iPhone

## For DDX6021BT/DDX6051BT

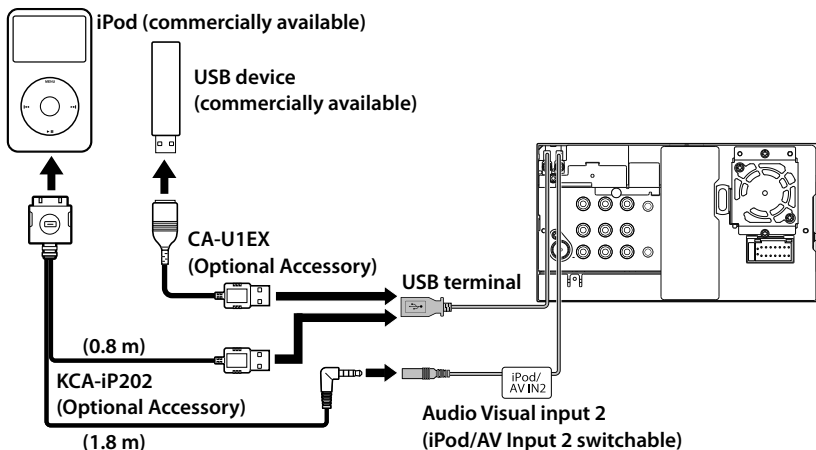

## For DDX4021BT/DDX4051BT/DDX3021/DDX3051

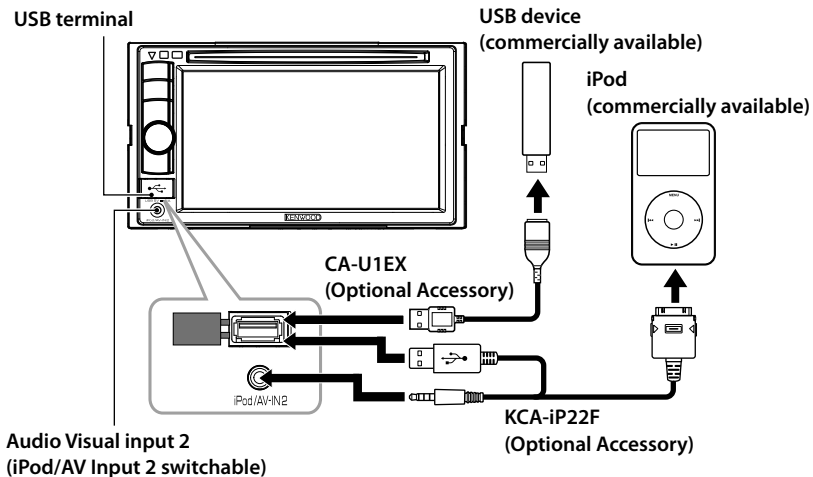

# Connecting Other Products

## Navigation System (Optional Accessory)

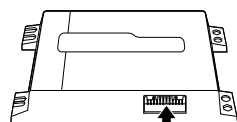

Navigation units that can be connected to this unit.  
(As of December, 2011):

- KNA-G620T
- KNA-G630

For latest information, access the [www.kenwood.com/cs/ce/](http://www.kenwood.com/cs/ce/).

Connection cable  
(Included in the Navigation System)

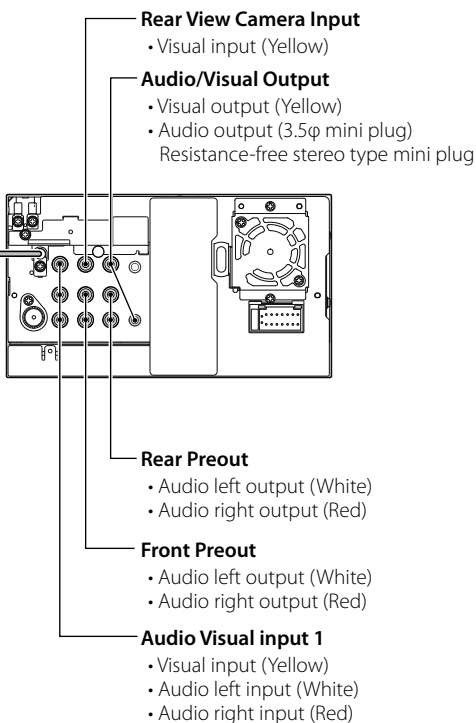

# Installing/Removing the Unit

## Installing the Escutcheon

1 Attach accessory ③ to the unit.

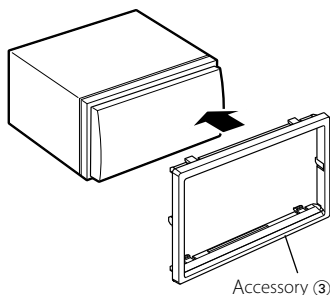

## Installing the Unit

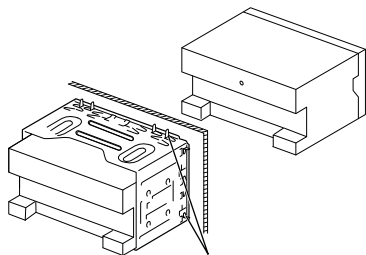

Bend the tabs of the mounting sleeve with a screwdriver or similar utensil and attach it in place.

For more stable attachment the unit (DDX6051BT/ DDX6021BT only)

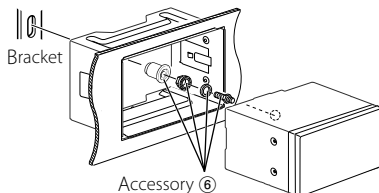

- Make sure that the unit is installed securely in place. If the unit is unstable, it may malfunction (eg, the sound may skip).

## Removing the Escutcheon (DDX4021BT/DDX4051BT/ DDX3021/DDX3051 only)

1 Engage the catch pins on the removal tool ④ and remove the two locks on the lower level. Lower the frame and pull it forward as shown in the figure.

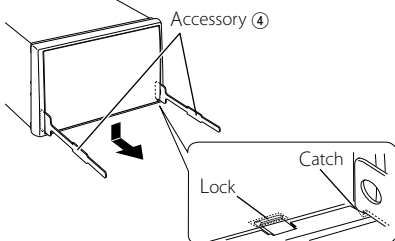

- The frame can be removed from the top side in the same manner.
- 2 When the lower level is removed, remove the upper two locations.

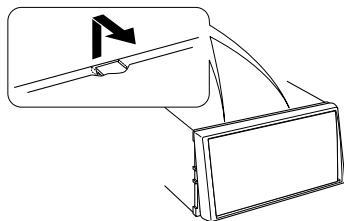



## Removing the Unit (DDX4021BT/DDX4051BT/ DDX3021/DDX3051 only)

- 1 Remove the escutcheon by referring to the removal procedure in the section <Removing the Escutcheon>.
- 2 Insert the two removal tools (4) deeply into the slots on each side, as shown.

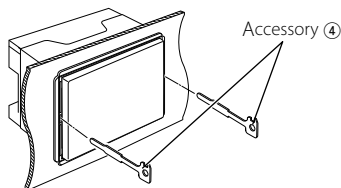

- 3 Lower the removal tool toward the bottom, and pull out the unit halfway while pressing towards the inside.

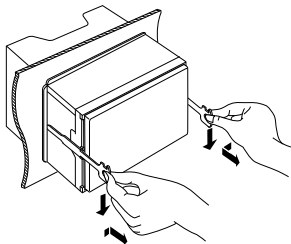

- Be careful to avoid injury from the catch pins on the removal tool.

- 4 Pull the unit all the way out with your hands, being careful not to drop it.

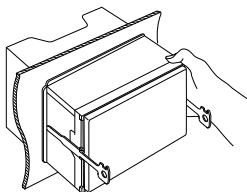

## Installing the Microphone Unit (DDX6021BT/ DDX6051BT/ DDX4021BT/ DDX4051BT only)

- 1 Check the installation position of the microphone (accessory 7).
- 2 Remove oil and other dirt from the installation surface.
- 3 Install the microphone.
- 4 Wire the microphone cable up to the unit with it secured at several positions using tape or the like.



- Install the microphone as far as possible from the cell-phone.

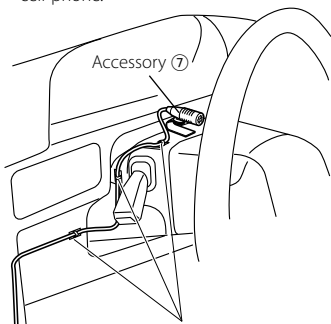

Fix a cable with a commercial item of tape.

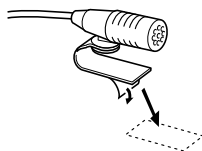

Peel the release coated paper of double-face adhesive tape to fix on the place shown above.



Adjust the direction of the microphone to the driver.

# Specifications

## Monitor section

### Picture Size

- : 6.95 inches (diagonal) wide  
156.6 mm (W) × 81.6 mm (H)  
(DDX6021BT/DDX6051BT)
- : 6.1 inches (diagonal) wide  
136.2 mm (W) × 72 mm (H)  
(DDX4021BT/DDX4051BT/DDX3021/  
DDX3051)

### Display System

- : Transparent TN LCD panel

### Drive System

- : TFT active matrix system

### Number of Pixels

- : 1,152,000 (800H × 480V × RGB)

### Effective Pixels

- : 99.99%

### Pixel Arrangement

- : RGB striped arrangement

### Back Lighting

- : LED

## DVD player section

### D/A Converter

- : 24 bit

### Audio Decoder

- : Linear PCM/Dolby Digital/dts/MP3/  
WMA/AAC/WAV

### Video Decoder

- : MPEG1/MPEG2/DivX

### Wow & Flutter

- : Below Measurable Limit

### Frequency Response

- Sampling frequency;
- 96 kHz: 20 – 22,000 Hz
- 48 kHz: 20 – 22,000 Hz
- 44.1 kHz: 20 – 20,000 Hz

### Total Harmonic Distortion

- : 0.010% (1 kHz)

### S/N Ratio (dB)

- : 99 dB (DVD-Video 96 kHz)

### Dynamic Range

- : 98 dB (DVD-Video 96 kHz)

### Disc Format

- : DVD-Video/MVIDEO-CD/CD-DA

### Sampling frequency

- : 44.1/48/96 kHz

### Quantifying Bit Number

- : 16/20/24 bit

## USB interface section

### USB Standard

- : USB 2.0 Full Speed

### File System

- : FAT 16/32

### Maximum Power Supply Current

- : DC 5 V  $\overline{\text{max}}$  1 A

### D/A Converter

- : 24 Bit

### Video Decoder

- : MPEG1/MPEG2/DivX

### Audio Decoder

- : MP3/WMA/AAC/WAV (Linear PCM)

## Bluetooth section (DDX6021BT/ DDX6051BT/DDX4021BT/DDX4051BT)

### Technology

- : Bluetooth 2.0 Certified

### Frequency

- : 2.402 – 2.480 GHz

### Output Power

- : +4dBm (MAX), 0dBm (AVE), Power  
Class2

### Maximum Communication range

- : Line of sight approx. 10m (32.8 ft)

### Profile

- HFP (Hands Free Profile),  
OPP (Object Push Profile),  
PBAP (Phonebook Access Profile),  
A2DP (Advanced Audio Distribution  
Profile),  
AVRCP (Audio/Video Remote Control  
Profile)

## FM tuner section

- Frequency Range (50 kHz)  
: 87.5 MHz – 108.0 MHz
- Usable Sensitivity (S/N: 26 dB)  
: 0.7  $\mu\text{V}/75 \Omega$
- Quieting Sensitivity (S/N: 46 dB)  
: 1.6  $\mu\text{V}/75 \Omega$
- Frequency Response ( $\pm 3.0$  dB)  
: 30 Hz – 15 kHz
- S/N Ratio (dB)  
: 65 dB (MONO)
- Selectivity ( $\pm 400$  kHz)  
:  $\geq 65$  dB
- Stereo Separation  
: 35 dB (1 kHz)

## LW tuner section

- Frequency Range (9 kHz)  
: 153 kHz – 279 kHz
- Usable Sensitivity  
: 45  $\mu\text{V}$

## MW tuner section

- Frequency Range (9 kHz)  
: 531 kHz – 1611 kHz
- Usable Sensitivity  
: 25  $\mu\text{V}$

## Video section

- Color System of External Video Input  
: NTSC/PAL
- External Video Input Level (RCA/mini jack)  
: 1 V<sub>p-p</sub>/75  $\Omega$
- External Audio Max Input Level (RCA/mini jack)  
: 2 V/25 k $\Omega$
- Video Output Level (RCA jack)  
: 1 V<sub>p-p</sub>/75  $\Omega$
- Audio Output Level (mini jack)  
: 1.2 V/10 k $\Omega$
- Analog RGB input  
: 0.7 V<sub>p-p</sub>/75  $\Omega$

## Audio section

- Maximum Power (Front & Rear)  
: 50 W  $\times$  4
- Full Bandwidth Power (Front & Rear)  
(PWR DIN 45324, +B=14.4V)  
: 30 W  $\times$  4
- Preout Level (V)  
: 4 V/10 k $\Omega$
- Preout Impedance  
:  $\leq 600 \Omega$
- Speaker Impedance  
: 4 – 8  $\Omega$
- Tone
- |         |                     |
|---------|---------------------|
| Bass:   | 100 Hz $\pm$ 8 dB   |
| Middle: | 1 kHz $\pm$ 8 dB    |
| Treble: | 12.5 kHz $\pm$ 8 dB |

## General

- Operating Voltage  
: 14.4 V (10.5 – 16 V allowable)
- Maximum Current Consumption  
: 10 A
- Dimensions (W  $\times$  H  $\times$  D)  
: 182  $\times$  111  $\times$  160 mm  
(DDX6021BT/DDX6051BT)  
182  $\times$  112  $\times$  163 mm  
(DDX4021BT/DDX4051BT/DDX3021/  
DDX3051)
- Operational Temperature Range  
:  $-10^{\circ}\text{C}$  –  $+60^{\circ}\text{C}$
- Storage Temperature Range  
:  $-20^{\circ}\text{C}$  –  $+85^{\circ}\text{C}$
- Weight  
: 2.5 kg  
(DDX6021BT/DDX6051BT)  
2.0 kg  
(DDX4021BT/DDX4051BT/DDX3021/  
DDX3051)

- Although the effective pixels for the liquid crystal panel is given as 99.99% or more, 0.01% of pixels may not light or may light incorrectly.
- Specifications are subject to change without notice.

- “DVD Logo” is a trademark of DVD Format/Logo Licensing Corporation registered in the US, Japan and other countries.
- The “AAC” logo is a trademark of Dolby Laboratories.
- Microsoft and Windows Media are either registered trademarks or trademarks of Microsoft Corporation in the United States and/or other countries.
- Manufactured under license from Dolby Laboratories. Dolby and the double-D symbol are trademarks of Dolby Laboratories.
- Manufactured under license under U.S. Patent Nos: 5,956,674; 5,974,380; 6,487,535 & other U.S. and worldwide patents issued & pending. DTS, the Symbol, & DTS and the Symbol together are registered trademarks & DTS 2.0 Channel is a trademark of DTS, Inc. Product includes software. © DTS, Inc. All Rights Reserved.
- “Made for iPod,” and “Made for iPhone” mean that an electronic accessory has been designed to connect specifically to iPod, or iPhone, respectively, and has been certified by the developer to meet Apple performance standards. Apple is not responsible for the operation of this device or its compliance with safety and regulatory standards. Please note that the use of this accessory with iPod or iPhone may affect wireless performance. iPhone, iPod, iPod classic, iPod nano, and iPod touch are trademarks of Apple Inc., registered in the U.S. and other countries.
- iTunes is a trademark of Apple Inc.
- DivX®, DivX Certified® and associated logos are trademarks of Rovi Corporation or its subsidiaries and are used under license.  
 ABOUT DIVX VIDEO: DivX® is a digital video format created by DivX, LLC, a subsidiary of Rovi Corporation. This is an official DivX Certified® device that plays DivX video. Visit [divx.com](http://divx.com) for more information and software tools to convert your files into DivX videos.  
 ABOUT DIVX VIDEO-ON-DEMAND: This DivX Certified® device must be registered in order to play purchased DivX Video-on-Demand (VOD) movies. To obtain your registration code, locate the DivX VOD section in your device setup menu. Go to [vod.divx.com](http://vod.divx.com) for more information on how to complete your registration.
- This item incorporates copy protection technology that is protected by U.S. patents and other intellectual property rights of Rovi Corporation. Reverse engineering and disassembly are prohibited.

# KS-UBT1 (USB Bluetooth Adapter)

## Instruction Manual

### ⚠ CAUTION

Changes or modifications not approved by us could void the user's authority to operate the equipment.

- This adapter has been designed exclusively for use with Kenwood car receivers. Do not use this adapter with any other car receiver. For details, see also the Instructions supplied with your receiver.
- The Bluetooth word mark and logos are owned by the Bluetooth SIG, Inc. and any use of such marks by JVC KENWOOD Corporation is under license. Other trademarks and trade names are those of their respective owners.

## Specifications

Bluetooth Version:	Bluetooth 2.0 Certified
Power Class:	Class2 Radio
Service Area:	10 m (10.9 yd)
USB Standards:	USB V1.1 (Full Speed)
Power Consumption:	54.3 mA/5 V (max.)
Dimensions (L × W × H):	15 mm × 19 mm × 5.6 mm (5/8" × 3/4" × 1/4")

Keep the Bluetooth adapter inserted when using the Bluetooth function.

When the adapter is removed, store it in a safe place.

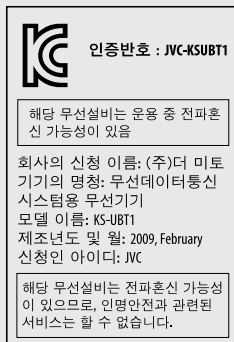
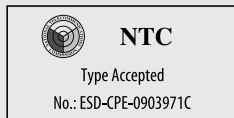

Distributor name: JVC KENWOOD DO BRASIL COMERCIO DE ELETRONICOS LTDA  
CNPJ of distributor: JVC KENWOOD DO BRASIL COMERCIO DE ELETRONICOS LTDA  
Manufacturer: JVC KENWOOD Corporation  
Model no.: KS-UBT1  
Brand: JVC



0178-11-6733



(01)07898929117502

“Este equipamento opera em caráter secundário, isto é, não tem direito à proteção contra interferência prejudicial, mesmo de estações do mesmo tipo, e não pode causar interferência a sistemas operando em caráter primário.”



Approved by TRA

MTC:OFICIO No 8396-2008-MTC/29

CONATEL certificate No: 001516

SUBTEL: 30234/DFRS00045/F-49

Complies with  
IDA Standards  
DB102150

“This telecommunication equipment conforms to NTC technical requirement”

13973/POSTEL/2010  
2366

TEC/WR/1/MOD-08/02/135.APR 08

URSEC 365/FR/2010

CNC 16-9371



## Declaration of Conformity with regard to the R&TTE Directive 1999/5/EC

### Manufacturer:

JVC KENWOOD Corporation

3-12 Moriya-cho, Kanagawa-ku, Yokohama-shi, Kanagawa, 221-0022, Japan

### EU Representative's:

Kenwood Electronics Europe BV

Amsterdamseweg 37, 1422 AC UITHOORN, The Netherlands

### English

Hereby, Kenwood declares that this unit KS-UBT1 is in compliance with the essential requirements and other relevant provisions of Directive 1999/5/EC.

### Français

Par la présente Kenwood déclare que l'appareil KS-UBT1 est conforme aux exigences essentielles et aux autres dispositions pertinentes de la directive 1999/5/CE.

Par la présente, Kenwood déclare que ce KS-UBT1 est conforme aux exigences essentielles et aux autres dispositions de la directive 1999/5/CE qui lui sont applicables.

### Deutsch

Hiermit erklärt Kenwood, dass sich dieser KS-UBT1 in Übereinstimmung mit den grundlegenden Anforderungen und den anderen relevanten Vorschriften der Richtlinie 1999/5/EG befindet. (BMW)

Hiermit erklärt Kenwood die Übereinstimmung des Gerätes KS-UBT1 mit den grundlegenden Anforderungen und den anderen relevanten Festlegungen der Richtlinie 1999/5/EG. (Wien)

### Nederlands

Hierbij verklaart Kenwood dat het toestel KS-UBT1 in overeenstemming is met de essentiële eisen en de andere relevante bepalingen van richtlijn 1999/5/EG.

Bij deze verklaart Kenwood dat deze KS-UBT1 voldoet aan de essentiële eisen en aan de overige relevante bepalingen van Richtlijn 1999/5/EC.

### Italiano

Con la presente Kenwood dichiara che questo KS-UBT1 è conforme ai requisiti essenziali ed alle altre disposizioni pertinenti stabilite dalla direttiva 1999/5/CE.

### Español

Por medio de la presente Kenwood declara que el KS-UBT1 cumple con los requisitos esenciales y cualesquiera otras disposiciones aplicables o exigibles de la Directiva 1999/5/CE.

### Português

Kenwood declara que este KS-UBT1 está conforme com os requisitos essenciais e outras disposições da Directiva 1999/5/CE.

### Polska

Kenwood niniejszym oświadcza, że KS-UBT1 spełnia zasadnicze wymogi oraz inne istotne postanowienia dyrektywy 1999/5/EC.

### Český

Kenwood tímto prohlašuje, že KS-UBT1 je ve shodě se základními požadavky a s dalšími příslušnými ustanoveními Nařízení vlády č. 426/2000 Sb.

### Magyar

Alulírott, Kenwood, kijelenti, hogy a jelen KS-UBT1 megfelel az 1999/5/EC irányelvben meghatározott alapvető követelményeknek és egyéb vonatkozó előírásoknak.

### Svenska

Härmed intygar Kenwood att denna KS-UBT1 står i överensstämmelse med de väsentliga egenskapskrav och övriga relevanta bestämmelser som framgår av direktiv 1999/5/EG.

### Suomi

Kenwood vakuuttaa täten että KS-UBT1 tyyppinen laite on direktiivin 1999/5/EY oleellisten vaatimusten ja sitä koskevien direktiivin muiden ehtojen mukainen.

### Slovensko

S tem Kenwood izjavlja, da je ta KS-UBT1 v skladu z osnovnimi zahtevami in ostalimi ustreznimi predpisi Direktive 1999/5/EC.

### Slovensky

Spoločnosť Kenwood týmto vyhlasuje, že KS-UBT1 spĺňa základné požiadavky a ďalšie príslušné ustanovenia Direktívy 1999/5/EC.

### Dansk

Undertegnede Kenwood erklærer herved, at følgende udstyr KS-UBT1 overholder de væsentlige krav og øvrige relevante krav i direktiv 1999/5/EF.

### Ελληνικά

ΜΕ ΤΗΝ ΠΑΡΟΥΣΑ Kenwood ΔΗΛΩΝΕΙ ΟΤΙ ΚΣ-UBT1 ΣΥΜΜΟΡΦΩΝΕΤΑΙ ΠΡΟΣ ΤΙΣ ΟΥΣΙΩΔΕΙΣ ΑΠΑΙΤΗΣΕΙΣ ΚΑΙ ΤΙΣ ΛΟΙΠΕΣ ΣΧΕΤΙΚΕΣ ΔΙΑΤΑΞΕΙΣ ΤΗΣ ΟΔΗΓΙΑΣ 1999/5/ΕΚ.

### Eesti

Sellega kinnitab Kenwood, et see KS-UBT1 vastab direktiivi 1999/5/EC põhilistele nõudmistele ja muudele asjakohastele määrustele.

### Latviešu

Ar šo, Kenwood, apstiprina, ka KS-UBT1 atbilst Direktīvas 1999/5/ EK galvenajām prasībām un citiem tās nosacījumiem.

### Lietuviškai

Šiuo, Kenwood, pareiškia, kad šis KS-UBT1 atitinka pagrindinius Direktyvos 1999/5/EB reikalavimus ir kitas svarbias nuostatas.

### Malti

Hawnhekk, Kenwood, jiddikjara li dan KS-UBT1 jikkonforma mal-tiġġijiet essenzjali u ma provvedimenti oħrajn relevanti li hemm fid-Direttiva 1999/5/EC.

### Українська

Компанія Kenwood заявляє, що цей виріб KS-UBT1 відповідає ключовим вимогам та іншим пов'язаним положенням Директиви 1999/5/EC.

### Türkçe

Bu vesileyle Kenwood, KS-UBT1 ünitesinin, 1999/5/EC Direktifinin başlıca gereksinimleri ve diğer ilgili hükümleri ile uyumlu olduğunu beyan eder.



---

**KENWOOD**