



KENWOOD

INSTRUCTION MANUAL

144/440 MHz FM DUAL BANDER

TH-D72A

144/430 MHz FM DUAL BANDER

TH-D72E

Version: 1.05

© JVC KENWOOD Corporation

CONTENTS

Operation	File name (TH-D72_)
OPERATING THROUGH REPEATERS REPEATER –	01_REPEATER_E.pdf
REPEATER ACCESS..... 1	
Selecting an Offset Direction..... 1	
Selecting an Offset Frequency..... 1	
Activating the Tone Function..... 1	
Selecting a Tone Frequency 2	
Automatic Repeater Offset..... 2	
TRANSMITTING A 1750 Hz TONE 3	
REVERSE FUNCTION 3	
AUTOMATIC SIMPLEX CHECKER (ASC)..... 3	
TONE FREQUENCY ID..... 3	
MEMORY CHANNELS MEMORY CH –	02_MEMORY CHANNEL_E.pdf
SIMPLEX & REPEATER OR ODD-SPLIT MEMORY CHANNEL?..... 1	
STORING SIMPLEX AND STANDARD REPEATER FREQUENCIES 1	
Call Channel Memory (Simplex) 1	
STORING ODD-SPLIT REPEATER FREQUENCIES..... 2	
Call Channel Memory (Odd-Split) 2	
RECALLING A MEMORY CHANNEL..... 2	
Memory Recall Method 2	
RECALLING A CALL CHANNEL..... 2	
CLEARING A MEMORY CHANNEL..... 2	
NAMING A MEMORY CHANNEL..... 3	
Frequency display <> memory name display..... 3	
MEMORY-TO-VFO TRANSFER..... 3	
CHANNEL DISPLAY FUNCTION..... 3	
SCANSCAN –	03_SCAN_E.pdf
SELECTING A SCAN RESUME METHOD 1	
Time-Operate Resume Time..... 1	
Carrier-Operated Resume Time..... 1	
VFO SCAN 2	
MEMORY SCAN..... 2	
Locking Out a Memory Channel..... 2	
GROUP SCAN..... 2	
Naming a Memory Group..... 3	
Memory Group Link..... 3	
Clearing a Memory Group..... 3	
PROGRAM SCAN 4	
Setting Scan Limits 4	
Using Program Scan 4	
MHz SCAN 4	
CALL SCAN..... 4	

CTCSS/ DCS/ CROSS TONE	CTCSS/ DCS/ CROSS TONE –
USING CTCSS	1
CTCSS FREQUENCY SCAN	2
USING DCS.....	2
DCS CODE SCAN.....	3
USING CROSS TONE.....	3
Selecting a Cross Tone mode.....	3
DUAL TONE MULTI-FREQUENCY (DTMF)	DTMF –
MANUAL DIALING	1
DTMF Hold.....	1
AUTOMATIC DIALER.....	1
Storing a DTMF Code in Memory	1
Transmitting Stored DTMF Codes	2
Selecting a Transmit Speed	2
Selecting a Pause Duration.....	2
DTMF KEY LOCK.....	2
EchoLink®	EchoLink –
STORING ECHOLINK MEMORY	1
Transmitting EchoLink Memory.....	1
Selecting a Transmit Speed	2
OTHER OPERATIONS	OTHER OP –
FULL DUPLEX.....	1
POWER ON MESSAGE	1
DISPLAY ILLUMINATION	1
Illumination Timer.....	1
Lamp Control.....	1
Display Contrast.....	1
BATTERY SAVER	1
AUTO POWER OFF (APO)	2
BATTERY TYPE.....	2
KEY LOCK.....	2
Key Lock Type	2
Microphone Key Lock.....	2
VOLUME BALANCE (BAND A/B).....	2
KEY BEEP	3
PROGRAMMABLE VFO.....	3
CHANGING THE FREQUENCY STEP SIZE	3
PROGRAMMABLE FUNCTION KEYS	3
Transceiver PF Key.....	3
Microphone Keys	4
FREQUENCY DIRECT ENTRY.....	4
SWITCHING FM/AM MODE.....	4
ADVANCED INTERCEPT POINT (AIP)	4
BEAT SHIFT	4
TX INHIBIT	5
TIME-OUT TIMER	5
SELECTING AN OUTPUT POWER	5
VOX (VOICE-OPERATED TRANSMISSION)	5

04_CTCSS_DCS_CROSS TONE_E.pdf

05_DTMF_E.pdf

06_EchoLink_E.pdf

07_OTHER OPERATIONS_E.pdf

VOX Gain	5	
VOX Delay Time	6	
VOX on Busy.....	6	
MASKING BANDS.....	6	
POWER ON PASSWORD.....	6	
GPS (GLOBAL POSITIONING SYSTEM).....	GPS –	08_GPS_E.pdf
INTERNAL GPS FUNCTION ON/OFF	2	
INTERNAL GPS SETUP	2	
Internal GPS operation mode.....	2	
Battery Saver (GPS Save)	3	
GPS DATA SETUP.....	3	
Land Survey System Datum	3	
Sentence	3	
SBAS	4	
TRACK LOG	4	
Track Log All Clear.....	4	
Overwriting the Track Log.....	4	
LOG SETUP	5	
Track Log Acquisition Type.....	5	
TARGET POINT	5	
MARK WAY POINT	6	
Copying the Mark Way Point to the Target Point.....	6	
Mark Way Point List	6	
Detailed Display of a Mark Waypoint	7	
PACKET OPERATION	PACKET –	09_PACKET_E.pdf
PACKET MODE.....	1	
DATA BAND	1	
TNC COMMANDS LIST.....	2	
APRS®	APRS –	10_APRS_E.pdf
CONNECTING TO AN EXTERNAL GPS UNIT OR WEATHER STATION.....	2	
ADJUSTING THE INTERNAL CLOCK	2	
Setting Date	2	
Setting Time	2	
Setting UTC Offset	2	
RECEIVING APRS DATA.....	3	
ACCESSING RECEIVED APRS DATA.....	3	
DISPLAY EXAMPLE.....	4	
SORT FUNCTION	5	
DISPLAY FILTER FUNCTION.....	6	
RECEIVING A MESSAGE	6	
ENTERING A MESSAGE	7	
TRANSMITTING A MESSAGE.....	8	
ACCESSING RECEIVED APRS MESSAGES	8	
BASIC SETTINGS	9	
My Callsign.....	9	
Beacon Type	9	
APRS Lock.....	9	
SETTING INTERNAL TNC	10	
Data Band	10	

Packet Transfer Rate	10
DCD Sense	10
TX delay time	10
SETTING COM PORT	10
Baud Rate	10
Input Type	10
Output Type	11
SETTING WAY POINT	11
Way Point Format	11
Way Point Length.....	11
Way Point Output.....	11
PC PORT ON/OFF	11
Output	11
PROGRAMMING POSITION DATA	11
Select Position channel.....	11
Name Entry	11
Latitude Entry	11
Longitude Entry	11
SETTING BEACON INFORMATION	12
Speed Information.....	12
Altitude Information	12
Position Ambiguity.....	12
SELECTING A POSITION COMMENT	12
STORING STATUS TEXT	13
QSY FUNCTION.....	13
QSY Transmission Operation	14
Operation when Receiving a QSY	14
SETTING PACKET FILTER.....	14
Position Limit.....	14
Packet Filter Type	14
SELECTING YOUR STATION ICON.....	15
SETTING TX BEACON	16
Packet Transmit Method	16
Quick Beacon.....	16
Initial Interval Time	16
SETTING ALGORITHM.....	16
Decay Algorithm.....	16
Proportional Pathing.....	17
SETTING SmartBeaconing™.....	17
Low speed / High speed.....	17
Slow rate	17
Fast rate	17
Turn angle	17
Turn slope	17
Turn time	17
PROGRAMMING A PACKET PATH.....	18
NETWORK	19
VOICE ALERT	20
WEATHER STATION DATA OUTPUT	20
Transmit	20
Transmit Interval Time	20

SETTING AS A DIGIPEATER	21	
DIGIPEAT	21	
UICHECK	21	
UIDIGI	21	
UIFLOOD	21	
UITRACE	22	
STORING USER PHRASES	22	
Reply	22	
Reply To Callsign	22	
Reply Delay Time	22	
Reply Text	23	
PROGRAMMING A MESSAGE GROUP CODE	23	
SETTING SOUND	23	
RX Beep Type	23	
TX Beep	23	
Special Call Sound	23	
SETTING DISPLAY	24	
Display Area	24	
Interrupt Time	24	
Cursor Control	24	
SELECTING A DISPLAY UNIT	25	
Speed, Distance	25	
Altitude, Rainfall	25	
Temperature	25	
Latitude longitude	25	
Grid Format	25	
SELECTING A NAVITRA GROUP	25	
Group Mode	25	
Enter Group Code	25	
STORING NAVITRA MESSAGE	25	
DX PACKETCLUSTERS MONITOR	26	
Connecting TH-D72 with the HF Transceiver	26	
TRANSCEIVER RESET	RESET –	11_RESET_E.pdf
KEY OPERATION	1	
MENU MODE	1	
SKY COMMAND SYSTEM II	SKY CMD –	12_SKY COMMAND_E.pdf
CONNECTING THE TRANSPORTER WITH THE HF TRANSCEIVER	1	
PREPARATION FLOW	2	
PROGRAMMING CALLSIGNS	3	
PROGRAMMING A TONE FREQUENCY	3	
CONTROL OPERATION	3	
WEATHER ALERT (TH-D72A ONLY)	WX –	13_WEATHER ALERT_TH-D72A_E.pdf
WEATHER ALERT ON/ OFF	1	
Weather Channel	1	
WEATHER ALERT SCAN	1	
WIRELESS OPERATION (TH-D72A ONLY)	WIRELESS OP –	14_WIRELESS_TH-D72A_E.pdf
PREPARATION	1	
CONTROL OPERATION	1	

OPERATING THROUGH REPEATERS

Repeaters are often installed and maintained by radio clubs, sometimes with the cooperation of local businesses involved in the communications industry.

Compared to simplex communication, you can usually transmit over much greater distances by using a repeater. Repeaters are typically located on mountain tops or other elevated locations. They generally operate at higher ERP (Effective Radiated Power) than a typical station. This combination of elevation and high ERP allows communications over considerable distances.

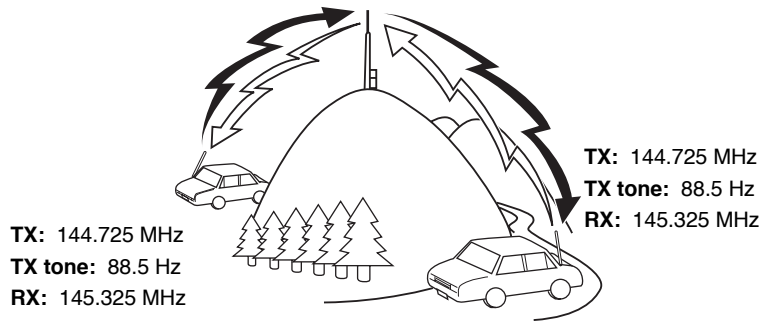

REPEATER ACCESS

Most repeaters use a receive and transmit frequency pair with a standard or non-standard offset (odd-split). In addition, some repeaters must receive a tone from the transceiver in order to gain access to the repeater. For details, consult your local repeater reference.

■ Selecting an Offset Direction

The offset direction allows your transmit frequency to be higher (+) or lower (-) than the receive frequency.

- 1 Select your desired band (A or B).
- 2 Press [F], [MHz] to select an offset direction.
 - Each time you press [F], [MHz], the offset direction changes as follows:

Simplex operation → + → - → Simplex operation

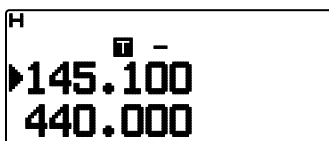
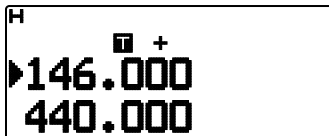

- If you are using a TH-D72E, when operating on the 430 MHz band, the offset direction changes as follows:

Simplex operation → + → - → (-7.6 MHz) → Simplex operation

If the offset transmit frequency falls outside the allowable range, transmitting is inhibited. Use one of the following methods to bring the transmit frequency within the band limits:

- Move the receive frequency further inside the band.
- Change the offset direction.

Note: While using an odd-split memory channel or transmitting, you cannot change the offset direction.

■ Selecting an Offset Frequency

The offset frequency is the value which the transmit frequency will be offset from the receive frequency. The default offset frequency on the 144 MHz band is 600 kHz for all type versions. The default on the 430/440 MHz band is 5 MHz.

- 1 Select your desired band (A or B).
- 2 Enter Menu mode and access Menu 160.



- 3 Set the appropriate offset frequency value.
 - The selectable range is from 00.00 MHz to 29.95 MHz, in steps of 50 kHz.

Note: After changing the offset frequency, the new offset frequency will also be used by Automatic Repeater Offset.

■ Activating the Tone Function

To turn the Tone function on:

- 1 Select your desired band (A or B).
- 2 Press [TONE] to turn the Tone function On.
 - Each time you press [TONE], the selection changes as follows:
Tone (T) → CTCSS (CT) → DCS (DCS) → Cross Tone (C) (default) → Off (no display).
<Additionally, when APRS is ON and Voice Alert is configured, Voice Alert ON is added to the above cycle.>
 - The "T" icon appears on the display when the tone function is On.

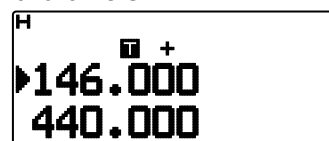

■ Selecting a Tone Frequency

To select the tone frequency required to access your desired repeater:

- 1 Turn the Tone function On.
- 2 Press [F], [TONE].
 - The current Tone frequency appears on the display and blinks. The default frequency is 88.5 Hz.



- 3 Press [▲]/[▼] or rotate the **Tuning** control to select your desired frequency.
 - To exit the tone frequency selection, press [ESC ◀].
- 4 Press [▶OK] to set the selected frequency.

Note: If you have set up a Memory channel with a tone setting, simply recall the Memory channel instead of setting up the tone frequency every time.

No.	Frequency (Hz)	No.	Frequency (Hz)	No.	Frequency (Hz)
01	67.0	16	110.9	31	186.2
02	69.3	17	114.8	32	192.8
03	71.9	18	118.8	33	203.5
04	74.4	19	123.0	34	206.5
05	77.0	20	127.3	35	210.7
06	79.7	21	131.8	36	218.1
07	82.5	22	136.5	37	225.7
08	85.4	23	141.3	38	229.1
09	88.5	24	146.2	39	233.6
10	91.5	25	151.4	40	241.8
11	94.8	26	156.7	41	250.3
12	97.4	27	162.2	42	254.1
13	100.0	28	167.9		
14	103.5	29	173.8		
15	107.2	30	179.9		

■ Automatic Repeater Offset

This function automatically selects an offset direction and activates the Tone function, according to the frequency that you have selected. To obtain an up-to-date band plan for repeater offset direction, contact your national Amateur Radio association.

- 1 Enter Menu mode and access Menu 161.



- 2 Set the ARO to "On".
- 3 Press [A/B] to select the A band.
- 4 Press [VFO] to select VFO mode.
- 5 Press [▲]/[▼] or rotate the **Tuning** control to select your desired frequency.

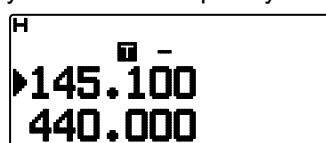

- 6 Press [PTT] to start a call.
 - You will be transmitting on an offset frequency value determined from your offset setting value and an offset direction depending on your selected frequency. Refer to the settings below for offset directions:

TH-D72A:

Under 145.100 MHz: No offset (Simplex operation)

145.100 ~ 145.499 MHz: – 600 kHz offset

145.500 ~ 145.599 MHz: No offset (Simplex operation)

146.000 ~ 146.399 MHz: + 600 kHz offset

146.400 ~ 146.599 MHz: No offset (Simplex operation)

146.600 ~ 146.999 MHz: – 600 kHz offset

147.000 ~ 147.399 MHz: + 600 kHz offset

147.400 ~ 147.599 MHz: No offset (Simplex operation)

147.600 ~ 147.999 MHz: – 600 kHz offset

148.000 MHz and higher: No offset (Simplex operation)

Under 442.000 MHz: No offset (Simplex operation)

442.000 ~ 444.999 MHz: + 5 MHz offset

445.000 ~ 446.999 MHz: No offset (Simplex operation)

447.000 ~ 449.999 MHz: – 5 MHz offset

450.000 MHz and higher: No offset (Simplex operation)

TH-D72E:

Under 145.000 MHz: No offset (Simplex operation)

145.600 ~ 145.799 MHz: – 600 kHz offset

145.800 MHz and higher: No offset (Simplex operation)

TRANSMITTING A 1750 Hz TONE

Most repeaters in Europe require that a transceiver transmit a 1750 Hz tone. On a TH-D72E, simply pressing **[CALL]** will transmit this tone. It is also possible to program [1750] on the front panel as a **[CALL]** key for transmitting the 1750 Hz tone.

- 1 Enter Menu mode and access Menu 162.



- 2 Set it to "1750Hz".

Some repeaters in Europe must receive continuous signals for a certain period of time, following a 1750 Hz tone. This transceiver is also capable of remaining in the transmit mode for 2 seconds after transmitting a 1750 Hz tone.

- 1 Enter Menu mode and access Menu 163.



- 2 Set it to "On".

Note: While remaining in the transmit mode, the transceiver does not continuously transmit a 1750 Hz tone.

REVERSE FUNCTION

After setting a separate receive and transmit frequency, you can exchange these frequencies using the Reverse function. This allows you to manually check the strength of signals you receive directly from other stations, while using a repeater. If the station's signal is strong, move to a simplex frequency to continue the contact and free up the repeater.

Press **[REV]** to turn the Reverse function On or Off

- When the Reverse function is On, the "R" icon will appear on the display.

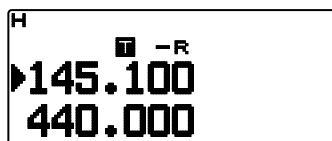

Note:

- ◆ If the transmit frequency is outside the allowable transmit frequency range when using Reverse, pressing **[PTT]** will cause an error tone to sound and transmission will be inhibited.
- ◆ If the receive frequency is outside the receive frequency range when using Reverse, an error tone will sound and Reverse will not operate.
- ◆ The ARO (Automatic Repeater Offset) will not function when Reverse is ON.
- ◆ You cannot switch Reverse On or Off while transmitting.

AUTOMATIC SIMPLEX CHECKER (ASC)

While using a repeater, ASC periodically monitors the strength of signals you receive directly from the other stations. If the station's signal is strong enough to allow direct contact without a repeater, the "R" icon blinks.

Press **[REV]** (1s) to turn the ASC On.

- When the ASC is On, the "R" icon will appear on the display.

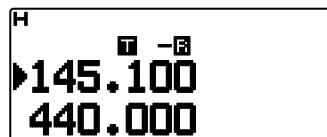

- While direct contact is possible, without the use of a repeater, the "R" icon will begin blinking.
- To exit ASC, press **[REV]**.

Note:

- ◆ Pressing **[PTT]** will cause the "R" icon to stop blinking.
- ◆ ASC does not function if you are using simplex operation.
- ◆ ASC does not function while scanning.
- ◆ Activating ASC while using Reverse will switch the Reverse function Off.
- ◆ If you recall a Memory channel or the Call channel, and those channels are set up with the Reverse function switched On, the ASC will switch Off
- ◆ You cannot use ASC when the built-in TNC is turned On.
- ◆ ASC causes received signals to be momentarily intermitted every 3 seconds.

TONE FREQUENCY ID

This function scans through all tone frequencies to identify the incoming tone frequency on a received signal. You can use this function to find which tone frequency is required by your local repeater.

- 1 Press **[TONE]** to switch the Tone function On.
 - The "R" icon appears on the display.
- 2 Press **[F]**, **[TONE]** (1s) to run the Tone Frequency ID scan.
 - Scan starts and "Scanning" blinks on the display.



- To reverse the scan direction, turn the **Tuning** control clockwise <or press **[▲]**> (upward scan) or counterclockwise <or press **[▼]**> (downward scan).
- To quit the function, press **[ESC ◀]**.
- When the tone frequency is identified, the identified frequency appears on the display and blinks. Press any key other than **[▶OK]** while the identified frequency is blinking, to resume scanning.



- 3 Press **[▶OK]** to program the identified frequency in place of the currently set tone frequency.
 - The Tone function will remain On. You can press **[TONE]** to switch the Tone function Off.
 - Press **[ESC ◀]** if you do not want to program the identified frequency.

MEMORY CHANNELS

In Memory channels, you can store frequencies and related data that you often use. Then you need not reprogram the data every time. You can quickly recall a programmed channel by simple operation. A total of 1000 Memory channels are available for bands A and B.

SIMPLEX & REPEATER OR ODD-SPLIT MEMORY CHANNEL?

You can use each memory channel as a simplex & repeater channel or as an odd-split channel. Store only one frequency to use as a simplex & repeater channel or two separate frequencies to use as an odd-split channel. Select either application for each channel depending on the operations you have in mind.

Simplex & repeater channels allow:

- Simplex frequency operation
- Repeater operation with a standard offset (if an offset direction is stored)

Odd-split channels allow:

- Repeater operation with a non-standard offset

The data listed below can be stored in each Memory channel:

Parameter	Simplex & Repeater	Odd-split
Receive frequency	Yes	Yes
Transmit frequency		Yes
Receive frequency step size	Yes	Yes
Transmit frequency step size		Yes
Offset direction	Yes	No
Tone On/Off	Yes	Yes
Tone frequency	Yes	Yes
CTCSS On/Off	Yes	Yes
CTCSS frequency	Yes	Yes
DCS On/Off	Yes	Yes
DCS code	Yes	Yes
Reverse On/Off	Yes	No
Memory channel lockout	Yes	Yes
Memory channel name	Yes	Yes
Demodulation mode	Yes	Yes

STORING SIMPLEX AND STANDARD REPEATER FREQUENCIES

- 1 Press [VFO] to enter VFO mode.
- 2 Press [▲]/[▼] or rotate the **Tuning** control to select your desired frequency.
- 3 Set up any additional data desired for the frequency.
 - Offset direction, Tone On/Off Tone frequency, CTCSS On/Off, CTCSS frequency, DCS On/Off, DCS code, etc.
- 4 Press [F], [MR].
 - A memory channel number appears.

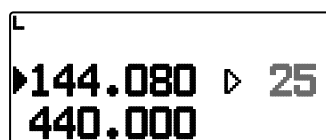

- 5 Press [▲]/[▼] or rotate the **Tuning** control to select your desired channel number.
 - When the selected channel number does not have stored data, the "▶" icon appears. When the channel does have stored data, the "▶" icon appears.
- 6 Press [▶OK] to store the data in the selected Memory channel.

Note: If you store the data in a Memory channel that already has data stored in it, the old data will be cleared and the new data will be stored.

■ Call Channel Memory (Simplex)

The Call channel can be used to store any frequency and related data that you will recall often. You may want to dedicate the Call channel as an emergency channel within your group.

To store a simplex frequency and related data as the Call channel instead of in a Memory channel, after step 4 (above), press [F], [CALL].

Note: Storing new data in the Call channel will clear the old data. (The Call channel itself cannot be cleared, but data can be replaced with new data.)

STORING ODD-SPLIT REPEATER FREQUENCIES

Some repeaters use a receive and transmit frequency pair with a non-standard offset. To access those repeaters, store two separate frequencies in a memory channel. You can then operate on those repeaters without changing the offset frequency you stored in the menu.

- 1 Set up a simplex channel by following steps 1 to 6 of “STORING SIMPLEX AND STANDARD REPEATER FREQUENCIES”, above.
- 2 Press **[VFO]** to enter VFO mode.
- 3 Press **[▲]/[▼]** or rotate the **Tuning** control to select your desired transmit frequency.
- 4 Set up any additional data desired for the transmit frequency.
 - Tone On/Off, Tone frequency, CTCSS On/Off., CTCSS frequency, DCS On/Off, DCS code, etc.
- 5 Press **[F]**.
 - A memory channel number appears.
- 6 Press **[▲]/[▼]** or rotate the **Tuning** control to select your desired channel number.

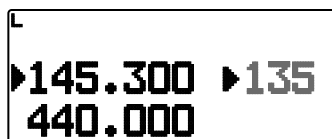

L
▶145.300 ▶135
440.000

- 7 Press **[▶OK]** while pressing **[PTT]** to store the data in the selected Memory channel.

■ Call Channel Memory (Odd-Split)

The Call channel can be used to store any frequency and related data that you will recall often. You may want to dedicate the Call channel as an emergency channel within your group.

To store an odd-split frequency and related data as the Call channel instead of in a Memory channel, after step 6 (above), press **[CALL]** while pressing **[PTT]**.

Note:

- ◆ You cannot set the transmission and reception frequencies on different bands.
- ◆ You cannot set a different frequency step size for the transmission and reception frequencies.
- ◆ You cannot store the transmit offset status and Reverse status in an odd-split Call channel.

RECALLING A MEMORY CHANNEL

- 1 Press **[MR]** to enter Memory Recall mode.
- 2 Press **[▲]/[▼]** or rotate the **Tuning** control to select your desired Memory channel.
 - Additionally, you can enter a channel number using the keypad.

■ Memory Recall Method

The transceiver Menu also provides you with the option to recall Memory channels with stored frequencies in your current band, or all Memory channels:

- 1 Enter Menu mode and access Menu 143.



Memory 143
▶Recall Method
All Bands

- 2 Set the recall method to “Current band” or “All bands”.
 - “Current band” allows you to recall only those memory channels that have stored frequencies within the current band. “All bands” allows you to recall all programmed memory channels.
 - When the recalled memory channel is an AM channel, you cannot recall on the A band.

RECALLING A CALL CHANNEL

- 1 Press **[CALL]** to enter Call Channel mode.

- “C” appears on the display.

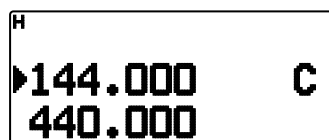

H
▶144.000 C
440.000

- If the frequency of the operating band is less than 300 MHz, the VHF CALL channel is used for recall. If the frequency is over 300 MHz, the UHF CALL channel is used for recall.

- 2 Press **[CALL]** again, the transceiver will return to the previous status (VFO mode or Memory Channel mode) before entering CALL mode.

Note: The [CALL] key of the TH-D72E is set to transmit the “1750Hz” tone as default. When using Call Channel mode, set Menu 162 [Repeater] – [CALL Key] to “Call”.

CLEARING A MEMORY CHANNEL

- 1 Press **[MR]** to enter Memory Recall mode.

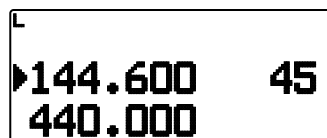

L
▶144.600 45
440.000

- 2 Turn the transceiver power Off.
- 3 Press **[MR] + Power ON** to enter Memory Channel Clear mode.



Clear Memory
KENWOOD 45
Clear? ▶[OK]

- 4 Press **[▲]/[▼]** or rotate the **Tuning** control to select your desired Memory channel.
- 5 Press **[▶OK]**.
 - “Sure?” appears on the display and blinks.



Clear Memory
KENWOOD 45
Sure? ▶[OK]

- 6 Press **[▶OK]** or **[MR]** to clear the Memory channel.
 - Repeat steps 4 to 6 to clear additional Memory channels.
 - To exit without clearing the channel, press **[ESC ◀]**.

NAMING A MEMORY CHANNEL

You can name Memory channels using up to 8 characters. When you recall a named Memory channel, its name appears on the display. Names can be callsigns, repeater names, cities, people, etc.

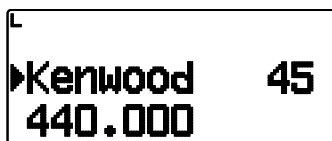

- 1 Press **[MR]** to enter Memory Recall mode.
- 2 Press **[▲]/[▼]** or rotate the **Tuning** control to select your desired Memory channel.
- 3 Enter Menu mode and access Menu 140.



- 4 Enter your desired name for the channel.

Note: You can overwrite a Memory channel name by performing the steps above. You can also clear a Memory channel name by clearing the Memory channel.

■ Frequency display < > memory name display

You can select the display method at the memory mode.

- 1 Enter Menu mode and access Menu 141.



- 2 Set the display method to "Name" or "Freq".

MEMORY-TO-VFO TRANSFER

Transferring the contents of a Memory channel or the Call channel to the VFO can be useful if you want to search for other stations or a clear frequency, near the selected Memory channel or Call channel frequency.

- 1 Press **[MR]** or **[CALL]** to enter Memory Recall mode or Call channel mode.
- 2 Press **[▲]/[▼]** or rotate the **Tuning** control to select your desired channel. (This step is not necessary when selecting the Call channel.)

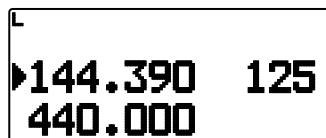

- 3 Press **[F]**, **[VFO]**.
 - The entire contents of the Memory channel or Call channel are copied to the VFO, and VFO mode is selected after the transfer is complete.
 - When copying a transmit frequency from an odd-split Memory or Call channel, you must first turn the Reverse function on before pressing **[F]**, **[VFO]**.

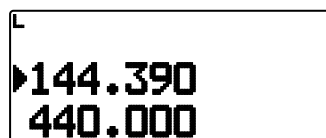

CHANNEL DISPLAY FUNCTION

Use this function when you want to use only Memory channels. When this function is switched on, the transceiver displays only a Memory channel number instead of a frequency.

- 1 Turn the transceiver power Off.
- 2 Press **[PTT] + [A/B] + Power ON** to turn the channel display On or Off.

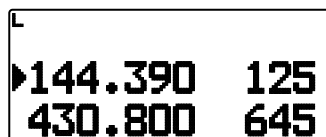
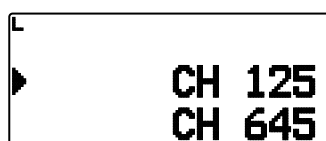

Note:

- ◆ If no Memory channels have saved data in them, channel display will not function.
 - ◆ When using Channel Display, you cannot reset the transceiver.
-

While in Channel Display mode, the transceiver keys function as shown next page:

Key Name	[KEY]	[F], [KEY]	[KEY] (1s)	MR mode	While Transmitting	[KEY] + Power ON
[PTT]	Transmission	–	X	TX/RX	X	–
[LAMP]	Backlight ON	Backlight ON continuously	Backlight ON	Backlight ON	Backlight ON	–
[MONI]	Monitor	Squelch setup	X	Monitor + Frequency	Monitor	–
[▲]	Memory CH Up	–	Memory CH continuously Up	Memory CH Up	–	–
[▼]	Memory CH Down	–	Memory CH continuously Down	Memory CH Down	–	–
[▶ OK]	–	–	–	–	–	–
[ESC ◀]	–	–	–	–	–	–
[MENU]	–	RF power select	–	–	DTMF Transmission	–
[A/B]	–	–	–	–	–	–
[1]	–	–	–	–	DTMF_1	–
[2]	–	–	–	–	DTMF_2	–
[3]	–	–	–	–	DTMF_3	–
[4]	–	–	–	–	DTMF_4	–
[5]	–	–	–	–	DTMF_5	–
[6]	–	–	–	–	DTMF_6	–
[7]	–	–	–	–	DTMF_7	–
[8]	–	–	–	–	DTMF_8	–
[9]	PF	–	–	–	DTMF_9	–
[*]	–	–	–	–	DTMF_*	–
[0]	DUAL	Full duplex	–	–	DTMF_0	–
[#]	ENT	–	–	–	DTMF_#	Version Info.
[A]	F	Function	Key lock	–	DTMF_A	X
[B]	–	–	–	–	DTMF_B	–
[C]	MR	–	Memory scan	–	DTMF_C	–
[D]	–	–	–	–	DTMF_D	–
	1750	–	X	–	–	–

SCAN

Scan is a useful feature for hands-off monitoring of your favorite frequencies. Becoming comfortable with all types of Scan will increase your operating efficiency.

This transceiver provides the following types of scans:

Scan Type	Scan Range
VFO Scan	Scans all frequencies on the current band.
Memory Scan	Scans all frequencies stored in the Memory channels.
Group Scan	Scans the frequencies in the Memory channels which belong to the group you have specified.
Program Scan	Scans all frequencies within the programmed range, on the current band.
MHz Scan	Scans all frequencies within a 1 MHz range from the originating frequency.
Call Scan	Scans the Call channel as well as the currently selected VFO frequency or Memory channel.

Note:

- ◆ Adjust the squelch level before using Scan. Selecting a squelch level too low could cause Scan to stop immediately.
- ◆ While using CTCSS or DCS, Scan stops for any signal received; however, scan will immediately resume if the received signal does not contain the same CTCSS tone or DCS code that you selected.
- ◆ Pressing and holding [PTT] causes Scan to temporarily stop if it is functioning on a non TX band.
- ◆ Starting Scan switches the Automatic Simplex Checker OFF.

SELECTING A SCAN RESUME METHOD

The transceiver stops scanning at a frequency or Memory channel on which a signal is detected. It then continues scanning according to which resume mode you have selected. You can choose one of the following modes. The default is Time-operated mode.

- **Time-Operated mode**
The transceiver remains on a busy frequency or Memory channel for approximately 5 seconds, and then continues to scan even if the signal is still present.
- **Carrier-Operated mode**
The transceiver remains on a busy frequency or Memory channel until the signal drops out. There is a 2 second delay between signal drop-out and scan resumption.
- **Seek mode**
The transceiver remains on a busy frequency or Memory channel even after the signal drops out and does not automatically resume scanning.

Note: To temporarily stop scanning and monitor weak signals, press [MONI].

- 1 Enter Menu mode and access Menu 150.

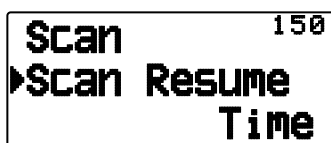

- 2 Set the Scan Resume mode to "Time" (Time-Operated), "Carrier" (Carrier-Operated) or "Seek" (Seek).

Time-Operate Resume Time

Set the hold time for the Time-Operate scan method.

When a signal is received, scan will pause at that frequency for the duration of the hold time you set. When the set time elapses, scan will resume (even if the signal is still being received).

- 1 Enter Menu mode and access Menu 151.



- 2 Set the resume time to 1 ~ 10 sec.

Carrier-Operated Resume Time

Set the hold time for the Carrier-Operate scan method.

When a signal is received, scan will pause at that frequency. When the signal stops, scan will resume after the duration of the hold time you set.

- 1 Enter Menu mode and access Menu 152.

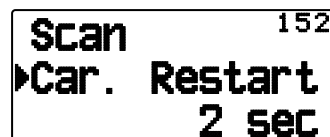

- 2 Set the resume time to 1 ~ 10 sec.

VFO SCAN

VFO Scan monitors all frequencies tunable on the band, using the current frequency step size.

- 1 Select your desired band.
- 2 Press **[VFO]** (1s).
 - Scan starts at the current frequency.
 - The 1 MHz decimal point blinks while scanning is in progress.
 - To reverse the scan direction, turn the **Tuning** control clockwise <or press **[▲]**> (upward scan) or counterclockwise <or press **[▼]**> (downward scan).

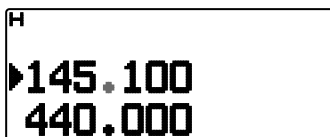

- 3 To quit VFO Scan, press **[VFO]** again.

MEMORY SCAN

Use Memory Scan to monitor all Memory channels programmed with frequency data.

- 1 Select your desired band.
- 2 Press **[MR]** (1s).
 - Scan starts at the current memory channel.
 - The 1 MHz decimal point blinks while scanning is in progress.
 - To reverse the scan direction, turn the **Tuning** control clockwise <or press **[▲]**> (upward scan) or counterclockwise <or press **[▼]**> (downward scan).
- 3 To quit Memory Scan, press **[MR]** again.

Note:

- ◆ At least 2 Memory channels must contain data and must not be locked out of scan.
- ◆ The L0/U0 to L9/U9 Memory channels will not be scanned.
- ◆ You can also start Memory Scan when in Channel Display mode. While Scan is paused on a channel, the channel number blinks.

Locking Out a Memory Channel

You can select Memory channels that you prefer not to monitor while scanning.

- 1 Press **[MR]**, then rotate the **Tuning** control to select your desired channel.
- 2 Enter Menu mode and access Menu 142.



- 3 Set the lockout to "On" to lock the channel out of the scanning sequence.
 - To cancel lockout, set the lockout to "Off".
 - The "L" icon appears on the display for a channel that has been locked out.

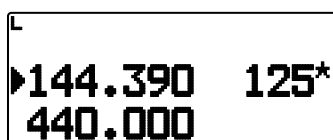

Note: The L0/U0 to L9/U9 Memory channels cannot be locked out.

GROUP SCAN

For the purpose of Group Scan, the 1000 Memory channels are divided into 10 groups, with each group containing 100 channels. Group Scan monitors only the 100 channels which belong to the specific group you are scanning. The channels are grouped as follows:

Memory Group	Channel Range	Memory Group	Channel Range
0	0 ~ 99	5	500 ~ 599
1	100 ~ 199	6	600 ~ 699
2	200 ~ 299	7	700 ~ 799
3	300 ~ 399	8	800 ~ 899
4	400 ~ 499	9	900 ~ 999

- 1 Press **[MR]**, then press **[▲]**/**[▼]** or rotate the **Tuning** control to select a channel in your desired group.
- 2 Press **[MHz]** (1s).
 - Scan starts at the current channel.
 - The 1 MHz decimal point blinks while scanning is in progress.
 - To reverse the scan direction, turn the **Tuning** control clockwise <or press **[▲]**> (upward scan) or counterclockwise <or press **[▼]**> (downward scan).
- 3 To quit Group Scan, press **[MHz]** again.

Note:

- ◆ At least 2 Memory channels in the selected group must contain data and must not be locked out of scan.
- ◆ You can also start Memory Scan when in Channel Display mode. While Scan is paused on a channel, the channel number blinks.

■ Naming a Memory Group

You can name Memory group using up to 8 characters.

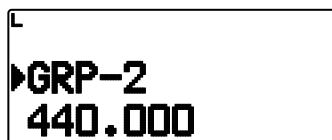

- 1 Press [MHz], then press [▲]/[▼] or rotate the **Tuning** control to select a channel in your desired group.
- 2 Enter Menu mode and access Menu 144.



- 3 Enter your desired name for the group.

Group name display (in MR mode)

- 1 Press [LAMP].
 - The group name is displayed.

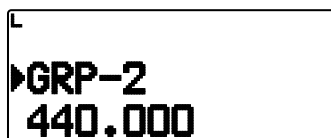

- 2 While pressing [LAMP] rotate the **Tuning** Control to change the group.
 - Rotate the **Tuning** control clockwise and release [LAMP] to select the smallest memory channel of the new group.
 - Rotate the **Tuning** control counter-clockwise and release [LAMP] to select the largest memory channel of the new group.

■ Memory Group Link

Memory Group Link provides you with the ability to link 2 or more Memory channel groups together to act as a single group when scanning. You can link up to 10 separate groups together, or even add multiple instances of the same group to the group link, to ensure that one group is scanned more often than the others.

- 1 Enter Menu mode and access Menu 145.
- 2 Press [▶OK].
 - The cursor will begin blinking.

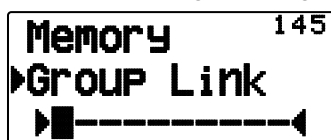

- 3 Press [▲]/[▼] or rotate the **Tuning** control to select a group to link.
- 4 Press [▶OK] to set the group and move the cursor to the right.
 - Press [ESC ◀] to move the cursor back or [▶OK] to move the cursor to the right.
- 5 Repeat steps 3 and 4 to link additional groups together.

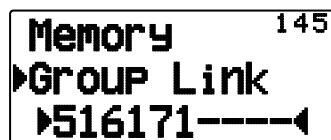

- 6 When you have entered your desired groups, press [▶OK] to move the cursor to the right, then press the **Tuning** control to complete the entry and exit Menu mode.
 - You can delete the selected character by pressing [A/B].
 - If you have entered the maximum of 10 groups, simply press [▶OK] to complete the entry and exit Menu mode.

■ Clearing a Memory Group

- 1 Press [MR] to enter Memory Recall mode.

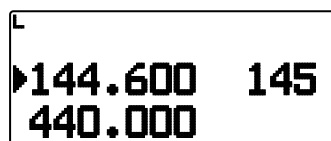

- 2 Turn the transceiver power Off.
- 3 Press [MHz] + **Power ON** to enter Group Clear mode.

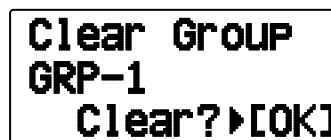

- 4 Press [▲]/[▼] or rotate the **Tuning** control to select your desired Group.
- 5 Press [▶OK].
 - "Sure?" appears on the display and blinks.

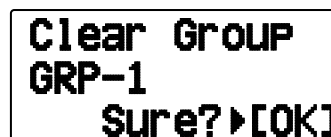

- 6 Press [▶OK] or [MR] to clear the Group.
 - Repeat steps 4 to 6 to clear additional Group.
 - To exit without clearing the channel, press [ESC ◀].

PROGRAM SCAN

Program Scan is identical to VFO Scan except that you select a frequency range for the scan.

■ Setting Scan Limits

You can store up to 10 scan ranges in Memory channels L0/U0 to L9/U9.

- 1 Press **[VFO]**.
- 2 Select your desired band.
- 3 Press **[▲]/[▼]** or rotate the **Tuning** control to select your desired frequency for the lower limit.

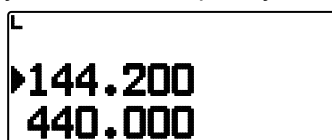

- 4 Press **[F]**, **[MR]**.
 - A memory channel number appears and blinks.
- 5 Press **[▲]/[▼]** or rotate the **Tuning** control to select a channel from L0 to L9.

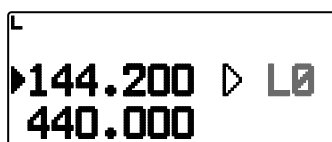

- 6 Press **[M.IN]** to set the channel number.
 - The lower limit is stored in the channel.
- 7 Press **[▲]/[▼]** or rotate the **Tuning** control to select your desired frequency for the upper limit.
- 8 Press **[F]**, **[MR]**.
- 9 Press **[▲]/[▼]** or rotate the **Tuning** control to select a matching channel number from U0 to U9.
 - For example, if you select channel L3 in step 5, select channel U3 here.
- 10 Press **[M.IN]** to set the channel number.
 - The upper limit is stored in the channel.
 - To confirm the stored scan limits, press **[MR]**, then select the L and U channels.

Note:

- ◆ The lower limit must be lower in frequency than the upper limit.
 - ◆ The lower and upper limits must be selected on the same band.
-

■ Using Program Scan

- 1 Select your desired band.
- 2 Press **[VFO]**.
- 3 Press **[▲]/[▼]** or rotate the **Tuning** control to select a frequency within your desired scan range.
- 4 Press **[VFO] (1s)**.
 - Scan starts at the current frequency.
 - The 1 MHz decimal point blinks while scanning is in progress.
 - To reverse the scan direction, turn the **Tuning** control clockwise <or press **[▲]**> (upward scan) or counterclockwise <or press **[▼]**> (downward scan).
- 5 To quit Program Scan, press **[VFO]** again.

Note: If the current VFO frequency is within more than one Program Scan range, the range stored in the smallest channel number is used.

MHz SCAN

MHz Scan monitors a 1 MHz segment of the band, using the current frequency step size. The current 1 MHz digit determines the limits of the scan. For example, if the current frequency is 145.400 MHz, then the scan range would be from 145.000 MHz to 145.995 MHz (the exact upper limit depends on the current frequency step size).

- 1 Select your desired band.
- 2 Press **[VFO]**.
- 3 Press **[▲]/[▼]** or rotate the **Tuning** control to select a frequency within your desired 1 MHz range.
- 4 Press **[MHz] (1s)** to start scanning.
 - Scan starts at the current frequency.
 - The 1 MHz decimal point blinks while scanning is in progress.
 - To reverse the scan direction, turn the **Tuning** control clockwise <or press **[▲]**> (upward scan) or counterclockwise <or press **[▼]**> (downward scan).
- 5 To quit MHz Scan, press **[MHz]** again.

CALL SCAN

Use Call Scan to monitor both the Call channel and either the currently selected VFO frequency or the currently selected Memory channel.

- 1 Select your desired VFO frequency or Memory channel.
- 2 Press **[CALL] (1s)** to start Call Scan.
 - The 1 MHz decimal point blinks while scanning is in progress.
 - When scanning with a Memory channel, the Call channel on the same band as the selected Memory channel is used for scan.
- 3 To quit Call Scan, press **[CALL]** again.

Note: The Memory channel selected is scanned even if it has been locked out of scan.

CTCSS/ DCS/ CROSS TONE

CTCSS

You may sometimes want to hear calls only from specific persons. The Continuous Tone Coded Squelch System (CTCSS) allows you to ignore (not hear) unwanted calls from other persons who are using the same frequency. To do so, select the same CTCSS tone as selected by the other persons in your group. A CTCSS tone is subaudible and is selectable from among 42 tone frequencies.

DCS

Digital Coded Squelch (DCS) is another application which allows you to ignore (not hear) unwanted calls. It functions the same way as CTCSS. The only differences are the encode/ decode method and the number of selectable codes. For DCS, you can select from 104 different codes.

Note: CTCSS/ DCS does not cause your conversation to be private. It only relieves you from listening to unwanted conversations.

CTCSS

- To cancel CTCSS, press [TONE] until "CT" no longer appears on the display.

USING CTCSS

- Select your desired band.
- Press [TONE] 2 times to activate the CTCSS function.
 - The "CT" icon appears on the display when the CTCSS function is On.
 - Each time you press [TONE], the selection changes as follows:
Tone (CT) → CTCSS (CT) → DCS (DCS) → Cross Tone (DFO: default) → Off (no display).
<Additionally, when APRS is ON and Voice Alert is configured, Voice Alert ON is added to the above cycle.>

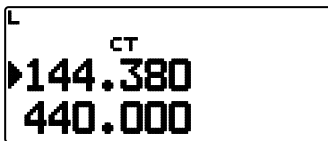

- Press [F], [TONE].
 - The current CTCSS frequency appears on the display and blinks. The default frequency is 88.5 Hz.



- Press [▲]/[▼] or rotate the **Tuning** control to select your desired CTCSS frequency.
 - Refer to the table below for the available frequencies.
 - To exit the CTCSS frequency selection, press [ESC ◀].
- Press [▶OK] to complete the setting.
- When you are called:** The transceiver squelch opens only when the selected CTCSS tone is received.
When you make a call: Press and hold [PTT], then speak into the microphone.

No.	Frequency (Hz)	No.	Frequency (Hz)	No.	Frequency (Hz)
01	67.0	16	110.9	31	186.2
02	69.3	17	114.8	32	192.8
03	71.9	18	118.8	33	203.5
04	74.4	19	123.0	34	206.5
05	77.0	20	127.3	35	210.7
06	79.7	21	131.8	36	218.1
07	82.5	22	136.5	37	225.7
08	85.4	23	141.3	38	229.1
09	88.5	24	146.2	39	233.6
10	91.5	25	151.4	40	241.8
11	94.8	26	156.7	41	250.3
12	97.4	27	162.2	42	254.1
13	100.0	28	167.9		
14	103.5	29	173.8		
15	107.2	30	179.9		

CTCSS FREQUENCY SCAN

This function scans through all CTCSS frequencies to identify the incoming CTCSS frequency on a received signal. You may find this useful when you cannot recall the CTCSS frequency that the other persons in your group are using.

- Press **[TONE]** 2 times to activate the CTCSS function.
 - The “**CT**” icon appears on the display when the CTCSS function is On.
 - Each time you press **[TONE]**, the selection changes as follows:
Tone (**T**) → CTCSS (**CT**) → DCS (**DCS**) → Cross Tone (**D**): default) → Off (no display).
<Additionally, when APRS is ON and Voice Alert is configured, Voice Alert ON is added to the above cycle.>

- Press **[F]**, **[TONE]** (1s).
 - Scan starts and “Scanning” blinks on the display.



- To quit the scan, press **[ESC ◀]**.
- When a CTCSS frequency is identified, the identified frequency appears on the display and blinks.



- Press **[▶ (OK)]** to program the identified frequency in place of the currently set CTCSS frequency.
 - The CTCSS function will remain on. To cancel CTCSS, press **[TONE]** until CT no longer appears on the display.
 - Press **[ESC ◀]** if you do not want to program the identified frequency.

DCS

USING DCS

- Select your desired band.
- Press **[TONE]** 3 times to activate the DCS function.
 - The “**DCS**” icon appears on the display when the DCS function is on.
 - Each time you press **[TONE]**, the selection changes as follows:
Tone (**T**) → CTCSS (**CT**) → DCS (**DCS**) → Cross Tone (**D**): default) → Off (no display).
<Additionally, when APRS is ON and Voice Alert is configured, Voice Alert ON is added to the above cycle.>

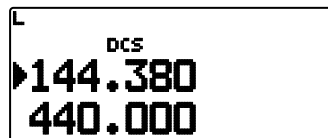

- Press **[F]**, **[TONE]**.
 - The current DCS code appears on the display and blinks.

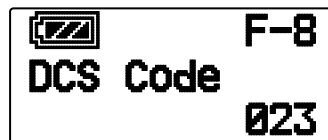

- Press **[▲]/[▼]** or rotate the **Tuning** control to select your desired DCS code.
 - Refer to the table below for the available codes.
 - To exit the DCS code selection, press **[ESC ◀]**.
- Press **[▶OK]** to complete the setting.
- When you are called:** The transceiver squelch opens only when the selected DCS code is received.
When you make a call: Press and hold **[PTT]**, then speak into the microphone.
 - To cancel DCS, press **[TONE]** until DCS no longer appears on the display.

DCS Code							
023	025	026	031	032	036	043	047
051	053	054	065	071	072	073	074
114	115	116	122	125	131	132	134
143	145	152	155	156	162	165	172
174	205	212	223	225	226	243	244
245	246	251	252	255	261	263	265
266	271	274	306	311	315	325	331
332	343	346	351	356	364	365	371
411	412	413	423	431	432	445	446
452	454	455	462	464	465	466	503
506	516	523	526	532	546	565	606
612	624	627	631	632	654	662	664
703	712	723	731	732	734	743	754

DCS CODE SCAN

This function scans through all DCS codes to identify the incoming DCS code on a received signal. You may find it useful when you cannot recall the DCS code that the other persons in your group are using.

- 1 Press **[TONE]** 3 times to activate the DCS function.
 - The “**DCS**” icon appears on the display when the DCS function is on.
 - Each time you press **[TONE]**, the selection changes as follows:
Tone (T) → CTCSS (CT) → DCS (DCS) → Cross Tone (D↙O: default) → Off (no display).
<Additionally, when APRS is ON and Voice Alert is configured, Voice Alert ON is added to the above cycle.>

- 2 Press **[F]**, **[TONE]** (1s).

- Scan starts and “Scanning” blinks on the display.



- To quit the scan, press **[ESC <]**.
- When a DCS code is identified, the identified code appears on the display and blinks.



- 3 Press **[▶OK]** to program the identified code in place of the currently set DCS code.
 - The DCS function will remain on. To cancel DCS, press **[TONE]** until DCS no longer appears on the display.
 - Press **[ESC <]** if you do not want to program the identified code.

CROSS TONE

USING CROSS TONE

You can set separate signaling types by TX and RX for when you access a repeater that uses different Encode/decode signaling.

To turn the Cross Tone function On:

Press **[TONE]** 4 times to activate the Cross Tone function.

- The “**D↙O**” (default) icon appears on the display when the Cross Tone function is On.
- Each time you press **[TONE]**, the selection changes as follows:
Tone (T) → CTCSS (CT) → DCS (DCS) → Cross Tone (D↙O: default) → Off (no display).
<Additionally, when APRS is ON and Voice Alert is configured, Voice Alert ON is added to the above cycle.>

■ Selecting a Cross Tone mode

To select the cross tone/code frequency required to access your desired repeater:

- 1 Turn the Cross Tone function On.
- 2 Press **[F]**, **[TONE]**.
 - The Cross Tone setting appears on the display.



- 3 Press **[▲]/[▼]** or rotate the **Tuning** control to select your desired Cross Tone setting.

Setting	Encode	Decode	Icon
DCS/Off	DCS	off	D↙O
TONE/DCS	Tone	DCS	T↙D
DCS/CTCSS	DCS	CTCSS	D↙C
TONE/CTCSS	Tone	CTCSS	T↙C

- To exit the Cross Tone setting selection, press **[ESC <]**.
- 4 Press **[▶OK]** to set the selected setting.

DUAL TONE MULTI-FREQUENCY (DTMF)

The keys on the keypad function as DTMF keys; the 12 keys found on a push-button telephone plus 4 additional keys (A, B, C, D). This transceiver provides 10 dedicated memory channels. You can store a DTMF code with up to 16 digits.

Some repeaters in the U.S.A. and Canada offer a service called Autopatch. You can access the public telephone network via such a repeater by sending DTMF tones. For further information, consult your local repeater reference.

MANUAL DIALING

Manual Dialing requires only two steps to send DTMF tones.

- 1 Press and hold **[PTT]**.
- 2 Press the keys in sequence on the keypad to send DTMF tones.
 - The corresponding DTMF tones are transmitted.
 - If the DTMF Hold function is activated, you not need hold down **[PTT]** while pressing keys. After transmitting the first tone (by pressing **[PTT]** and the first key), pressing additional keys will keep the transceiver in transmit mode for 2 seconds.

Frequency (Hz)	1209	1336	1447	1633
697	[1]	[2]	[3]	[A]
770	[4]	[5]	[6]	[B]
852	[7]	[8]	[9]	[C]
941	[*]	[0]	[#]	[D]

■ DTMF Hold

Activate this function to remain in transmit mode, after beginning to press keys when making a call.

- 1 Enter Menu mode and access Menu 173.



DTMF 173
▶Hold
Off

- 2 Set DTMF Hold to "On" to continue transmitting when pressing keys.
 - Set this menu to "Off" to stop the 2 second continuous transmission.

AUTOMATIC DIALER

There are 10 dedicated DTMF Memory channels available to store DTMF codes. You can store up to 16 digits in each channel.

■ Storing a DTMF Code in Memory

- 1 Enter Menu mode and access Menu 170.



DTMF 170
▶Memory

- 2 Press **[▶ (OK)]**



DTMF MR CH
▶0:

- 3 Press **[▲]/[▼]** or rotate the **Tuning** control to select a channel number.
- 4 Press **[▶OK]** or **[MENU]** to set the selected channel number.

- The name entry display appears.



DTMF MR Name
0: ▶Ken_____◀

- 5 Enter a name for the channel, then press **[▶OK]** or **[MENU]** to set it.

- The code entry display appears.



DTMF MR Code
0: Kenwood
▶01_____

- 6 Enter a DTMF code for the channel, then press **[▶OK]** or **[MENU]** to set it.
 - When a space is entered, it becomes a "Pause" code.

■ Transmitting Stored DTMF Codes

- 1 Press and hold [PTT].
- 2 While transmitting, press [MENU].
 - The last called DTMF Memory channel number and name appears on the display. If no name has been saved for the channel, the DTMF code appears.

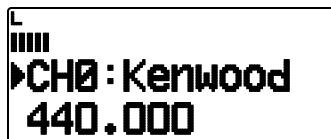

- 3 While still transmitting, press [▲]/[▼] or rotate the **Tuning** control to select your desired DTMF Memory channel, then press [▶OK] or [MENU] to transmit DTMF code.
 - Additionally, you can press a DTMF key corresponding to your desired channel ([0] ~ [9]) to select the channel and begin transmission.
 - The stored DTMF code scrolls across the display and is transmitted.
 - The code will be transmitted even if you release [PTT] before the entire code has scrolled across the display.

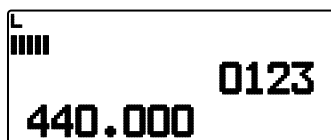
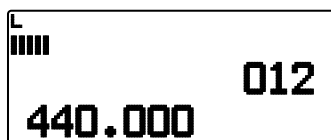

- If no DTMF code is stored in the selected channel, the frequency display is restored.

■ Selecting a Transmit Speed

Some repeaters may not respond correctly if a DTMF code is retransmitted at fast speed. If this happens, change the DTMF code transmission speed; the default is 100 msec.

- 1 Enter Menu mode and access Menu 171.



- 2 Select a speed (in msec) from the available list: 50/100/150.

■ Selecting a Pause Duration

You can change the pause duration stored in DTMF Memory channels; the default is 500 msec.

- 1 Enter Menu mode and access Menu 172.



- 2 Select a pause duration (in msec) from the available list: 100/ 250/ 500/ 750/ 1000/ 1500/ 2000.

DTMF KEY LOCK

This function will lock the DTMF transmission keys so that they will not transmit if they are accidentally pressed while transmitting. To lock the DTMF keys, turn this function On.

- 1 Enter Menu mode and access Menu 181.



- 2 Set the key lock to "On" or "Off".

What is EchoLink ?

EchoLink allows you to communicate with other amateur radio stations over the internet, using VoIP (voice-over-IP) technology. The EchoLink software program allows worldwide connections to be made between stations, or from computer to station, greatly enhancing your communications capabilities.

Official EchoLink Website: <http://www.echolink.org>

Note: EchoLink is a registered trademark of Synergenics, LLC.

STORING EchoLink MEMORY

There are 10 dedicated EchoLink DTMF memory channels available to store DTMF codes. Each channel can also store an associated name/callsign/title using up to 8 alphanumeric characters.

Note: EchoLink memory channels do not store operating frequencies, tones, or power information.

- 1 Enter Menu mode and access Menu 146.



- 2 Press [▶OK]
- 3 Press [▲]/[▼] or rotate the **Tuning** control to select an EchoLink channel number from 0 ~ 9.



- 4 Press [▶OK] or [MENU] to set the selected channel number.
 - The name entry display appears.



- 5 Enter the name for the channel, then press [▶OK] or [MENU] to set it.
 - The callsign and conference name (for board rooms that can do round QSO) of the other station which is connected via EchoLink, or the control command name, etc., are entered into the EchoLink memory name.
 - The code entry display appears.

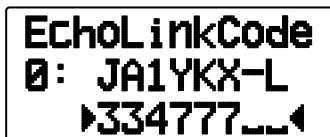

- 6 Enter a DTMF code for the channel, then press [▶OK] or [MENU] to set it.
 - The node number of the other station and conference which are connected via EchoLink, or the DTMF code of the control command, etc., are entered into the EchoLink code.

■ Transmitting EchoLink Memory

- 1 Press and hold [PTT].
- 2 While transmitting, press [MENU].
 - The last called EchoLink DTMF Memory channel name and number appears on the display.

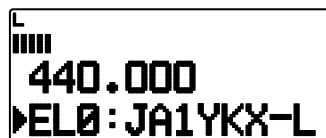

- 3 While still transmitting, press [▲]/[▼] or rotate the **Tuning** control to select your desired EchoLink Memory channel, then press [MENU] or [▶OK] to transmit DTMF code.
 - The stored code scrolls across the display and is transmitted.

Note:

- ◆ In step 2, press [C] key before pressing [▶OK], to transmit the converted DTMF code of the EchoLink "Connect by Call" function. (example: JA1YKX)
"C" "51 21 10 93 52 92 #" (# is automatically added to the end of the DTMF code)
- ◆ In step 2, press [0] [7] keys before pressing [▶OK], to transmit the converted DTMF code of the EchoLink "Query by Call" function. (example: JA1YKX)
"0" "7" "51 21 10 93 52 92 #" (# is automatically added to the end of the DTMF code)
- ◆ When only the EchoLink memory name has been registered, the EchoLink "Connect Call" function transmits the converted DTMF code. (example: JA1YKX)
"C 51 21 10 93 52 92 #" (C is automatically added to the beginning of the DTMF code and # is automatically added to the end)
- ◆ **Callsign/ DTMF Code Conversion Table**
When a character other than an alphanumeric character is used (such as "-" and "/"), the DTMF conversion stops at the character before that non-standard character.

	1	2	3	4	5	6	7	8	9	0
0	1	2	3	4	5	6	7	8	9	0
1	Q	A	D	G	J	M	P	T	W	
2	Z	B	E	H	K	N	R	U	X	
3		C	F	I	L	O	S	V	Y	

■ Selecting a Transmit Speed

Some EhoLink node station may not respond correctly if a DTMF code is transmitted at fast speed. If this happens, change the DTMF code transmission speed; the default is 100 msec.

- 1 Enter Menu mode and access Menu 171.



- 2 Select a speed (in msec) from the available list: 50/100/150.

Note: This setting is common with DTMF memory.

OTHER OPERATIONS

FULL DUPLEX

This transceiver is also capable of simultaneously transmitting and receiving signals. So, it is possible to transmit audio on the current band while receiving packet data on another band (data band).

- 1 Set the operation band to Band B.
- 2 Press [F], [DUP] to enter Full Duplex mode.
 - “DUP” appears.

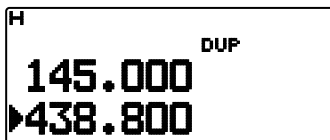

To exit Full Duplex mode, press [F], [DUP] again.

Note:

- ◆ When the operating band is Band A, you cannot change to Full Duplex mode.
- ◆ When in single band mode, and Band A/B is set to VHF/VHF or UHF/UHF, you cannot change to Full Duplex mode.
- ◆ When using the Full Duplex function, connect an earphone to the SP jack. Using an earphone will prevent feedback that can cause the transceiver to emit a howling sound.

ATTENTION: Use only after verifying that there is no reception disruption during communications.

POWER ON MESSAGE

Each time you switch the transceiver on, “HELLO” (default) appears on the display for approximately 2 seconds. You can program your favorite message in place of the default message.

- 1 Enter Menu mode and access Menu 100.



- 2 Enter your desired message.
 - Press [A/B] to clear the entire message, if necessary.

DISPLAY ILLUMINATION

You can manually change the display illumination to suit the lighting conditions where you are operating.

■ Illumination Timer

Set the duration that the display illumination remains on.

- 1 Enter Menu mode and access Menu 101.



- 2 Select a time (in sec) from the available list: 2 ~ 10.

■ Lamp Control

The display illumination will light either when any key is pressed or only when the [LAMP] key is pressed, depending on the setting.

- 1 Enter Menu mode and access Menu 102.



- 2 Set the Lamp Control Type to “Manual” or “Auto”.

Manual: The backlight turns on when the [LAMP] key is pressed.

Auto: The backlight turns on when operating any key or when turning the Tuning control.

The backlight will turn off according to the Illumination Timer setting, or when the [LAMP] key is pressed.

■ Display Contrast

The display visibility changes depending on the ambient conditions, for example between daytime and night. When you find the display is not clear, use this function to select the optimum display contrast.

- 1 Enter Menu mode and access Menu 103.



- 2 Set your desired contrast level from 1 to 8.

Note: The display contrast may be affected by a change in temperature. Adjust the contrast as necessary.

BATTERY SAVER

The Battery Saver extends the operating time of the transceiver. It automatically activates when the squelch is closed and no key is pressed for more than 10 seconds. To reduce battery consumption, this function shuts the receiver circuit OFF for the programmed time, then momentarily turn it back ON to detect a signal.

To program the receiver shut-off period for the battery saver:

- 1 Enter Menu mode and access Menu 110.

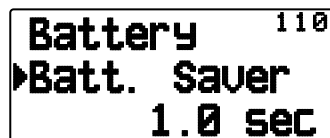

- 2 Set the receiver shut-off period time to 0.03, 0.2, 0.4, 0.6, 0.8, 1.0, 2.0, 3.0, 4.0, 5.0 seconds, or “Off”.

Note: To prevent Packet miss-decoding while using APRS, set the Battery Saver to “Off” or “0.03”.

AUTO POWER OFF (APO)

Automatic Power off is a background function that monitors whether or not any operations have been performed (keys pressed, **Tuning** control turned, etc.), and turns the transceiver power off if it has not been in use.

- 1 Enter Menu mode and access Menu 111.

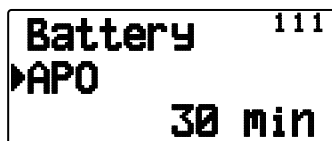

- 2 Set the APO time limit to 15, 30, 60 minutes, or "Off".
 - After the time limit passes with no operations (default is "Off"), APO turns the transceiver power off. However, 1 minute before the power turns off, "APO" appears on the display and blinks, and a warning tone sounds.



Note:

- ◆ If any settings are changed during while APO is ON, the timer resets. When you stop changing the settings, the timer begins counting again from 0.
- ◆ When the APRS beacon is automatically transmitted (other than Manual/PTT), the APO timer will not be extended.

BATTERY TYPE

Depending on the type of batteries you are using in the transceiver, adjust the battery type to match. The battery indicator can only accurately read out the remaining battery power if this value is set correctly.

- 1 Enter Menu mode and access Menu 112.



- 2 Set the Battery Type to "Lithium" or "Alkaline".

KEY LOCK

The Key Lock function ensures that your transceiver settings will remain unchanged if you accidentally press a key. When activated, the following functions can still be used:

[**⏏**]/ [PTT]/ [LAMP]/ [SQL]/ [F] (1s)/ [F] + [LAMP]

To turn Key Lock On or Off, press [F] (1s).

- When Key Lock is activated, the "LK" icon will appear on the display.

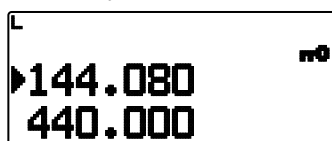

Key Lock Type

Select a Lock type.

- 1 Enter Menu mode and access Menu 180.



- 2 Set the Key Lock type to "Key Lock", "F.Lock", or "Key & F.Lock".

Key Lock: Locks all the front panel keys. (Press [F] (1s) to unlock the keys.)

F.Lock: Locks the frequency or the memory channel. (The [MHz], [ENT], [MR], [BAND], Scan, [PF] (Group Up and WX) keys/functions cannot be used.)

Key & F.Lock: Locks all the front panel keys along with the Tuning control. (Press [F](1s) to unlock the keys.)

- The [LAMP], [MONI], [PTT], [**⏏**], and VOL control knob cannot be locked.

Microphone Key Lock

The Microphone Key Lock function will lock the microphone PF (Programmable Function) keys.

- 1 Enter Menu mode and access Menu 182.

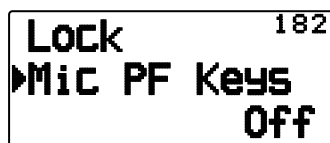

- 2 Set the Microphone Key Lock function "On" or "Off".

VOLUME BALANCE (BAND A/B)

You can regulate the volume balance between the A band (upper indicator) and the B band (lower indicator).

- 1 Enter Menu mode and access Menu 120.



- 2 Adjust the volume balance.

KEY BEEP

You can turn the transceiver beep function “Off”, “RADIO & GPS”, “RADIO Only” or “GPS Only as desired.

- 1 Enter Menu mode and access Menu 121.



Audio 121
▶Key Beep
RADIO & GPS

- 2 Set the beep function to “Off”, “RADIO & GPS”, “RADIO Only” or “GPS Only”.
 - Even with the beep function turned off, the transceiver will emit a beep tone under the following conditions:
 - 1) When Auto Power off is activated, the transceiver will beep 1 minute before the power turns off.
 - 2) After transmitting for the maximum time duration according to the Time-out Timer, the transceiver will beep.

Note: The APRS-related beeps comply with the settings of the APRS menu, rather than from this setting.

PROGRAMMABLE VFO

If you always check frequencies within a certain range, you can set upper and lower limits for frequencies that are selectable. For example, if you select 144 MHz for the lower limit and 145 MHz for the upper limit, the tunable range will be from 144.000 MHz to 145.995 MHz.

- 1 Select your desired VFO frequency.
- 2 Enter Menu mode and access Menu 130.

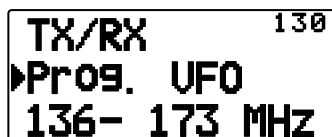

TX/RX 130
▶Prog. VFO
136- 173 MHz

- 3 Press [▶OK].
 - The lower frequency limit blinks.

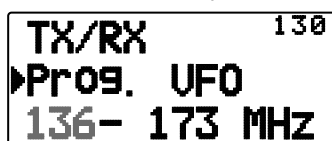

TX/RX 130
▶Prog. VFO
136- 173 MHz

- 4 Press [▲]/[▼] or rotate the **Tuning** control to select your desired lower frequency limit, then press [▶OK] to set the selected value.

- The upper frequency limit blinks.

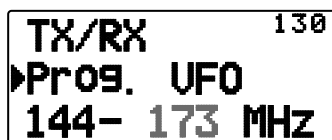

TX/RX 130
▶Prog. VFO
144- 173 MHz

- 5 Press [▲]/[▼] or rotate the **Tuning** control to select your desired upper frequency limit, then press [▶OK] to set the selected value.

- 6 Press [ESC ◀] to exit Menu mode.

Note: You cannot program the 100 kHz and subsequent digits. The exact 100 kHz and subsequent digits of the upper limit depend on the frequency step size you are using.

CHANGING THE FREQUENCY STEP SIZE

Choosing the correct frequency step size is essential in selecting your exact frequency. The default step size on the 144 MHz band is 5 kHz (TH-D72A) or 12.5 kHz (TH-D72E). The default on the 430/440 MHz band is 25 kHz.

Each band can have a separate selectable step frequency.

- 1 Press [A/B] to select band A or B, then press [VFO].
- 2 Press [F], [ENT].



F-#
STEP
5.0 kHz

- 3 Set the step size to 5.0, 6.25, 8.33, 10.0, 12.5, 15.0, 20.0, 25.0, 30.0, 50.0, or 100.0 kHz.

Note:

- ◆ Each band can have a separate selectable step frequency.
- ◆ Changing between step sizes may correct the displayed frequency. For example, if 144.995 MHz is displayed with a 5 kHz step size selected, changing to a 12.5 kHz step size corrects the displayed frequency to 144.9875 MHz.

PROGRAMMABLE FUNCTION KEYS

■ Transceiver PF Key

This is [PF] (Programmable Function) key on the transceiver front panel. You can assign your own desired functions to this key.

- 1 Enter Menu mode and access Menu 190.



Auxiliary 190
▶PF Key
GPS

- 2 Set your desired function for the key. Programmable functions available are:

WX (Weather Channel)/ GROUP UP (Memory group up)/ MR.Name ⇄FREQ (Memory name ⇄ Frequency)/ VOX/ MR GRP NAME (Memory group name)/ BAL (Balance)/ GPS/ LOG/ SQL/ SHIFT/ DUP (Full duplex)/ BAND/ STEP/ LOW/ LOCK M>V (Memory to VFO Copy)/ M.IN/ C.IN/ T.SEL/ NEW/ VA/ DX/ WX1

Microphone Keys

There are 3 microphone PF (Programmable Function) keys: [PF1], [PF2], and [PF3]. You can assign your own desired functions to these 3 keys.

- 1 Enter Menu mode and access Menu 191 (MIC. PF1) and/or Menu 192 (MIC. PF2) and/or Menu 193 (MIC. PF3).

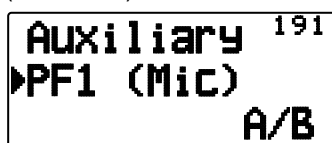

- 2 Set your desired function for the key. Programmable functions available are:

WX (Weather Channel)/ GROUP UP/ MR.Name <> /FREQ/ VOX/ MR GRP (Memory group up)/ NAME/ BAL/ GPS/ LOG/ SQL/ SHIFT (Shift)/ DUP/ BAND/ STEP/ LOW/ LOCK/ M>V/ M.IN/ C.IN/ T.SEL/ NEW/ VA/ DX/ WXI/ A/B (Band Select A/ Band Select B)/ MENU (Menu mode)/ MARK/ TNC/ POS /MSG/ LIST/ BCON/ VFO/ REV (Reverse)/ TONE/ MR/ MHz/ DUAL (Dual Mode)/ ENT/ CALL/ LAMP/ MONI (Monitor)

FREQUENCY DIRECT ENTRY

If the desired operating frequency is far from the current frequency, using the keypad is the quickest way to change the frequency.

- 1 Press [A/B] to select band A or B, then press [VFO] or [CALL].
- 2 Press [ENT].
 - The Direct Frequency Entry display appears.

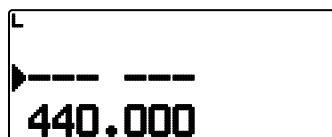

- 3 Press the keys ([0] ~ [9]) to enter your desired frequency.
- 4 To set the entered frequency, press [ENT] or [VFO].
 - Pressing [ENT] before entering all of the digits will set the remaining digits to 0.
 - Pressing [VFO] before entering all of the digits will leave the remaining digits at their previous values.
 - Entering all digits for a frequency will automatically set the frequency without pressing [ENT] or [VFO].
 - In step 3, after entering 1 ~ 3 digits, pressing [MHz] will set the digits above the MHz value.

For example, when the displayed frequency is 432.250:

- 1 Press [ENT] ⇒ -----
- 2 Press [4] ⇒ 4-----
- 3 Press [MHz] ⇒ 4 3 4.---

SWITCHING FM/AM MODE

This transceiver is also capable of receiving (not transmitting) in AM on band B. The default mode on the 118 MHz band is AM while the default on the 144, 300, or 430/440 MHz band is FM.

- 1 Enter Menu mode and access Menu 131.

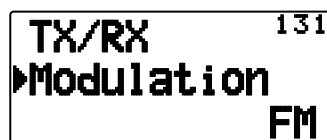

- 2 Set the mode to AM, FM, or NFM.

Note: You cannot switch between FM and AM to receive on band A.

ADVANCED INTERCEPT POINT (AIP)

The VHF/UHF band is often crowded in urban areas. AIP helps eliminate interference and reduce audio distortion caused by inter modulation. You can use this function only while operating on the VHF/UHF band.

- 1 Enter Menu mode and access Menu 132 (VHF AIP) and/or Menu 133 (UHF AIP).



- 2 Set the AIP to "On" or "Off".

BEAT SHIFT

Since the transceiver uses a microprocessor to control various transceiver functions, the CPU clock oscillator's harmonics or image may appear on some spots of the reception frequencies. Select a Beat Shift setting from Type 1 ~ Type 8, which does not cause interference. The default is Type 1 (Off).

- 1 Enter Menu mode and access Menu 138.



- 2 Set the Beat Shift to "Type 1" ~ "Type 8".

TX INHIBIT

You can inhibit the transmission to prevent unauthorized individuals from transmitting, or to eliminate accidental transmissions while carrying the transceiver.

- 1 Enter Menu mode and access Menu 139.



- 2 Set the TX inhibit to "On" or "Off".

- "TX Inhibit" appears and an error beep sounds if the transceiver tries to transmit while TX Inhibit is ON.



TIME-OUT TIMER

The Time-out Timer limits the duration you transmit. Just before the transceiver stops the transmitting, a warning beep sounds. This function is necessary to protect the transceiver from thermal damage and can therefore not be turned OFF.

- 1 Enter Menu mode and access Menu 13A.

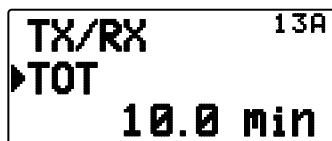

- 2 Set the desired time to 0.5/ 1.0/ 1.5/ 2.0/ 2.5/ 3.0/ 3.5/ 4.0/ 4.5/ 5.0/ 10.0 (default) minutes.

SELECTING AN OUTPUT POWER

It is a good idea to select lower transmit power if communications is still reliable. This lowers the risk of interfering with others on the band. When operating from battery power, you will enjoy more operating time before a recharge is necessary.

Press [F], [MENU] to select high (H), low (L), or economic low (EL) power.

- You can program different power settings for bands A and B.

Note: When the transceiver overheats because of ambient high temperature or continuous transmission, the protective circuit may function to lower transmit output power.

VOX (VOICE-OPERATED TRANSMISSION)

VOX eliminates the necessity of manually switching to Transmit mode each time you want to transmit.

The transceiver automatically switches to Transmit mode when the VOX circuitry senses that you have begun speaking into the microphone.

When you operate the VOX function, you must use an optional Headset; the internal speaker and microphone are too close to each other to be used for the VOX function.

To turn the VOX function ON:

- 1 Enter Menu mode and access Menu 134.



- 2 Set it to "On".

- When VOX is activated, the "☒" icon, gain level, and delay time will appear on the display.

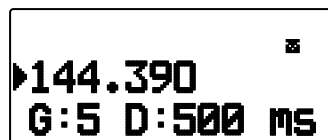

Note:

- ◆ While in Menu mode, the VOX function is temporarily disabled.
- ◆ Since the VOX circuit must detect the presence of your voice, you may notice a slight delay in transmission; the very first part of your message may not be transmitted.
- ◆ When the VOX function is ON, the ASC function turns OFF.
- ◆ VOX cannot be used with an optional Speaker/ Microphone.

VOX Gain

To enjoy the VOX function, take the time to properly adjust the VOX Gain level. This level controls the VOX circuit to detect the presence or absence of your voice.

There are 2 ways to adjust the VOX Gain.

While the VOX function is ON:

- 1 Speak into the headset microphone using your normal tone of voice to transmit.
 - If the transmission does not begin, you must readjust the VOX Gain so that transceiver transmits while you are speaking. To readjust the gain, press and hold [PTT] then press [▲]/[▼] to select a more sensitive gain level.
 - While readjusting the gain, you can release [PTT]. The transceiver will remain in Adjustment Mode for approximately 5 seconds.
- 2 Adjust the VOX Gain by pressing [▲]/[▼] until the transceiver reliably switches to transmission mode each time you speak while the transceiver is transmitting.

From the Menu:

- 1 Enter Menu mode and access Menu 135.

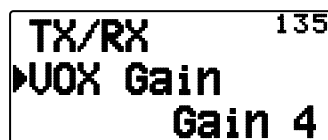

- 2 Select the desired VOX gain level.

■ VOX Delay Time

If the transceiver returns to reception mode too quickly after you stop speaking, the end of your transmission may not be sent. To avoid this, select an appropriate delay time that allows your entire transmission to be sent, before Transmit mode ends. However, do not make the delay overly long.

- 1 Enter Menu mode and access Menu 136.



TX/RX 136
▶VOX Delay
500 ms

- 2 Set the desired delay time to 250, 500 (default), 750, 1000, 1500, 2000, or 3000 ms.

Note:

- ◆ If you press [PTT] while the VOX function is ON, the VOX Delay Time is not reflected to the transmission.
- ◆ If you press [CALL] (if 1750 Hz is programmed) to transmit a 1750 Hz tone, the VOX Delay Time is not reflected.
- ◆ If the DCS function is ON, the transceiver remains in Transmit mode for the duration set by the VOX Delay Time. It then sends a Turn-Off Code to close the receiving party's squelch.

■ VOX on Busy

You can configure the transceiver to force VOX transmission even if the transceiver is receiving a signal.

- 1 Enter Menu mode and access Menu 137.

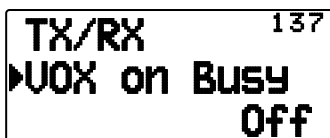

TX/RX 137
▶VOX on Busy
Off

- 2 Set it to "On" or "Off".

Note: You can press [PTT] or [CALL] (if 1750 Hz is programmed) to transmit, regardless of the setting in Menu No. 137.

MASKING BANDS

If you have no plans to use a certain frequency band, you can hide the frequency display on the unused band. This allows for easier reading of the frequency band.

- 1 Turn the transceiver power off.
- 2 Press [A/B] + Power ON.
 - The band mask display appears.



B Band Mask
▶Band 118 MHz
Use

- 3 Press [▲]/[▼] or rotate the **Tuning** control to select the band you want to hide (or return to normal).
- 4 Press [▶OK] to set the selected band.
- 5 Press [▲]/[▼] or rotate the **Tuning** control to set the band to select "Use" or "Mask".
 - "Use" allows you to see and use the band as normal.
 - "Mask" hides the band on the display.



B Band Mask
▶Band 118 MHz
Mask

- 6 Press [▶OK] control to set the selection.
- 7 Press the [ESC ◀] to exit.

Note:

- ◆ You cannot operate the masked band nor use it to receive or transmit.
- ◆ You cannot mask all frequency bands.

POWER ON PASSWORD

If power on password is activated, you cannot operate the transceiver without first entering your password, after turning the transceiver power on. Your password can be changed using the MCP-4A software, and can contain up to 6 digits.

- 1 Enter Menu mode and access Menu 19A.

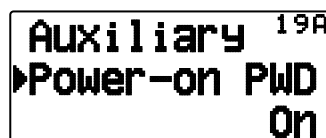

Auxiliary 19A
▶Power-on PWD
On

- 2 Set the power on password to "On" or "Off".
 - When set to "On", "PASSWORD" appears on the display.



PASSWORD

- 3 Enter your password.



PASSWORD
**-----

- 4 After entering up to 6 digits, press [▶OK] to set the password.

Note: Even with Menu 19A turned on, the power on password function will not be activated unless you first program a password using the MCP-4A software.

GPS (GLOBAL POSITIONING SYSTEM)

What is GPS?



GPS, standing for Global Positioning System, is becoming common nowadays. Following is a brief introduction.

The American Defense Department developed GPS originally for military operations. The system is available for use by the general public. For example, anybody can use GPS in association with modern vehicle navigation systems. Position precision for public use is approximately 15 m.

Moreover, precision can be improved when a vehicle is used for navigation and aboard ships through use of map matching technology and differential GPS techniques.

A total of 24 or more GPS satellites are at a high-level altitude of approximately 20,000 km on six circular tracks with an orbital radius of approximately 26,000 km. Therefore, there are four or more satellites located in each orbital track. For civilian use, the RF carrier frequency of the satellites is 1575.42 MHz. Spread spectrum (SS) technology is used over a bandwidth of 2.046 MHz to prevent interference among all the satellite signals on a common carrier frequency.

Position Determination Principle

The GPS receiver receives the radio signals transmitted from the GPS satellites. The receiver measures the time duration between when the signal leaves the satellite and when the signal arrives at the GPS receiver. Knowing this time allows calculation of the distance that the signal traveled from that particular satellite. By receiving multiple signals from different satellites and doing this distance calculation multiple times, the intersection of the spherical surfaces that represent the respective radius distances to the various satellites will determine a single point.

The precision of the determination of the intersecting point relies on the satellites and the data collected.

Datum (Geodetic Survey System)

The latitude and longitude information required by the GPS receiver does not allow for accurate representation of the unevenness of the Earth's surface. For use with GPS, the current standard that defines the precise shape of the Earth is called WGS-84. By using this standard in conjunction with mapping standards for each country, accurate position plotting on a map can be done.

GPS and APRS Position Format

Although position can be described in many different formats, such as degrees, degrees and minutes, and degrees, minutes and seconds, the GPS system and APRS have standardized on the degrees and decimal minutes format. Just like it is important to use proper international phonetics when spelling on the air, it is important in APRS as in any communications system to have a default standard for position. All operators should be trained to use the DDD MM.mm format by default in voice communications just like in data formats. Using these standards on the air will prevent communications errors, confusion, repeats, and conversions.

Interval and Total Distance

Geographic Coordinates	Format	Example
Latitude	DD MM.mm (degrees and minutes)	39 49.31N +39 49.31
Longitude	DDD MM.mm (degrees and minutes)	84 15.39W -84 15.39

INTERNAL GPS FUNCTION ON/OFF

Turn this function Off when connecting an external GPS receiver to the COM terminal.

Press **[F]**, **[MARK]** to turn the Internal GPS receiver ON or OFF.

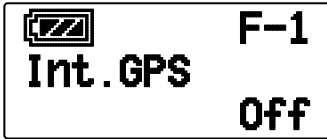

- When the Internal GPS receiver is ON, the “iGPS” indicator appears on the display.

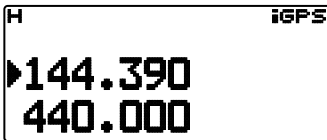

- When the Internal GPS receiver is On, the internal clock is automatically configured with the time data from the internal GPS receiver.
- You must set the time zone beforehand, through Menu No. 196.
- When determining your position for the first time after the power supply is turned On, the clock data is automatically set and is updated once per day thereafter.

When the Internal GPS receiver is On, pressing **[POS]** will display “Latitude longitude”, then press **[▶OK]** to cycle the display between “Time, Altitude, Travel direction, speed” >> “Target point distance, Travel direction” >> “Log meter” >> “GPS satellite information”.

- Press **[ESC◀]** to return to the previous display.

<Latitude longitude>

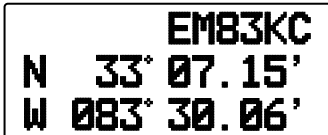

<Time, Altitude, Travel direction, speed>

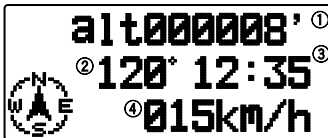

- ① Altitude ② Travel direction ③ Time ④ Travel Speed

<Target point distance, Travel direction>

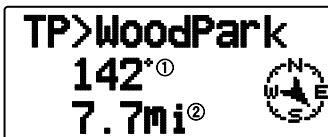

- ① Travel direction ② Target point distance

- When pressing **[F]** while the target point distance/ traveling direction is displayed, the North Up display (displays North as the top) changes to the Heading Up display (displays the current travel direction as the top) or vice-versa. In the Heading Up display, a “+” or “-” is used to help indicate the traveling direction.



<Log meter>



<GPS satellite information>

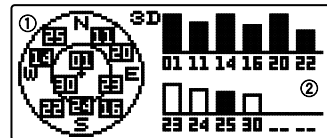

- ① Sky view ② Satellite signal-strength bars

The sky view shows the satellites you are receiving. The satellite signal-strength bars indicate the strength of each satellite you are receiving. A solid bar indicates that the GPS satellite is ready for use.

- When only the frame of the signal-strength bar is displayed, the satellite has not yet been captured.

Note:

- ◆ When GPS cannot be received, turn the power ON in a clear environment (Open Sky).
- ◆ While the above screen is displayed (the GPS satellite information screen is positioning) press **[MARK]** (1s) to register a Mark Waypoint.
- ◆ While the above screen is displayed, pressing **[PTT]** will change to the frequency display and transmission will begin. Once transmission is complete, the transceiver returns to the original display.
- ◆ You may experience interference on the internal GPS receiver when using in or around 147.0, 443.8 MHz (Band A) and/or 438.9 MHz (Band B). To eliminate the interference, swap Band A/ Band B or change the frequency.

INTERNAL GPS SETUP

■ Internal GPS operation mode

Enter Menu mode and access Menu 200.

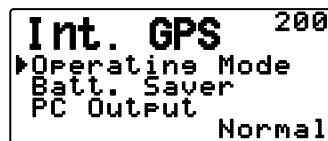

GPS Only: The display shows only GPS information; The transceiver transmit and receive capabilities are turned OFF; only GPS operation is available.

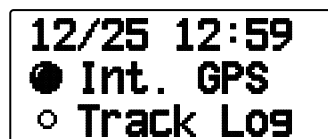

- The “●” icon appears when the function is turned ON, the “○” icon appears when the function is turned OFF.
- The “INT. GPS” “●” icon icon blinks while determining the position.

Normal: The display continues to show your frequency, You can use it as a normal transceiver.

When set to “GPS Only”, you can operate only the following key functions.

Key Name	[KEY]	[F], [KEY]	[KEY] (1s)	[KEY] + Power ON
[LAMP]	Lamp	Continuous Lamp On	Lamp	–
[▲] [▼] [▶ OK] [ESC ◀]	–	Function/ Menu select	–	–
[MENU]	Menu mode	RF power select	–	–
[A/B]	–	–	–	–
[1]	MARK	–	Register mode of Mark Waypoint	–
[2]	–	Starting the LOG function	–	–
[3]	POS	–	–	–
[F]	Function mode	–	–	Reset mode

■ Battery Saver (GPS Save)

This function will turn the GPS power source Off after the programmed timer expires if position data is not determined during the maximum catching time (approximately 5 minutes). To prevent unnecessary battery consumption, when there are many reception satellites, the GPS is stabilized and position data can be determined, the GPS power source repeatedly turns On and Off.

- 1 Enter Menu mode and access Menu 201.

```

Int. GPS 201
Operating Mode
▶ Batt. Saver
PC Output
Auto
  
```

- 2 Set GPS Off time to “Off”, 1, 2, 4, 8, or “Auto”.

Auto: When set to Auto, the GPS Off time starts at 1 minute for the first time, then progresses to 2 minutes, 4 minutes and 8 minutes each additional time. The GPS Off time remains at 8 minutes thereafter. However, after having determined your position for the duration, if the GPS cannot pinpoint your location, the GPS Off time will restart at 1 minute.

Note:

- ◆ Position precision may be improved by setting the Batter Saver (GPS Save) function to “Off”.
- ◆ You cannot set the SBAS function to “On” when the Batter Saver (GPS Save) function is 1, 2, 4, 8, or Auto. Set the Battery Saver (GPS Save) function to “Off”.

■ GPS Data PC Output

Turn this function on when you want to send the Internal GPS receiver data (NMEA) from the PC terminal using.

- 1 Enter Menu mode and access Menu 202.

```

Int. GPS 202
Operating Mode
Batt. Saver
▶ PC Output
Off
  
```

- 2 Set PC Output to “Off” or “On”.

GPS DATA SETUP

■ Land Survey System Datum

When using the Internal GPS receiver, set up the necessary land surveying system.

For APRS, select “WGS-84” (world land surveying system).

- 1 Enter Menu mode and access Menu 210.

```

Setup 210
▶ Datum
Sentence
SBAS
WGS-84
  
```

- 2 Set Datum to “WGS-84”.

- This function does not work when using an external GPS receiver.

■ Sentence

Adds an NMEA sentence to the Internal GPS receiver data output from the PC.

- 1 Enter Menu mode and access Menu 211.

```

Setup 211
Datum
▶ Sentence
SBAS
*$GPGGA
  
```

- 2 Set Sentence to “\$GPGGA”, “\$GPGLL”, “\$GPGSA”, “\$GPGSV”, “\$GPRMC”, “\$GPVTG”, or “\$GPZDA”.

- With BEACON transmission, the “\$GPGGA” “\$GPRMC” check (✦) cannot be removed in necessary information and satellite image information.
- You cannot output an NMEA sentence from an external GPS receiver to a PC.

■ SBAS

Through the SBAS (Satellite Based Augmentation System) geostationary satellite, when using the system which offers the information of wide scope reinforcement, set this function to "On".

- 1 Enter Menu mode and access Menu 212.



- 2 Set SBAS to "Off" or "On".

Note: When the Battery Saver (GPS Save) setting is 1, 2, 4, 8, or Auto, you cannot the SBAS setting is "On".

TRACK LOG

All movement is saved in the GPS LOGGER. Saved information includes latitude, longitude, altitude, travel direction, speed, time, and date. The log can retain up to 5000 points of data.

Press [F], [TNC] to turn the Track Log function On or Off.



When turning the Track Log function On, "Log Start" appears for approximately 5 seconds, followed by the "iLOG" icon.



- When setting Menu 200 to "GPS Only" and the Track Log function is turned On, the "●" icon appears.

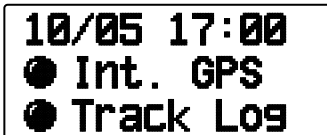

- When turning the Track Log function Off, "Log Stop" appears on the display for approximately 5 seconds.



- With the Track Log function On, even if the power source is turned Off during Log acquisition, the log is backed up so that when the power is turned back on, the log acquisition resumes.
- You can verify the Log activity ratio in the GPS pinpointing screen.



Note:

- ◆ When the Track Log is turned On while the GPS is Off, the GPS will also turn On.
- ◆ When the GPS is not pinpointing, data is not saved to the log.
- ◆ Using the MCP-4A, you can read the Track Log.
- ◆ If the Track Log overwriting configuration is turned Off (see below), "Log Full" appears when the log memory is full.
- ◆ When the APRS is On, Log operation will begin only when the APRS menu COM terminal input is Off.

■ Track Log All Clear

- 1 Enter Menu mode and access Menu 220.



- 2 Select "Yes" or "No".

Selecting "Yes" will clear the entire Track Log.

■ Overwriting the Track Log

When the Track Log becomes full, new data will begin overwriting the oldest Track Log data

- 1 Enter Menu mode and access Menu 221.



- 2 Select "On" or "Off".

Selecting "On" will allow old data to be overwritten with new data.

LOG SETUP

■ Track Log Acquisition Type

You can set the conditions for saving portable Track information as GPS Logger.

You can change the settings for travel speed, etc.

- 1 Enter Menu mode and access Menu 230.

```

Log Setup 230
▶Record Method
Interval
Distance
Time
    
```

- 2 Select "Time", "Distance", or "Beacon" for the Record Method.

- 3 Access Menu 231.

```

Log Setup 231
Record Method
▶Interval
Distance
10 sec
    
```

- 4 Select an Interval time from 2 ~ 1800 seconds (in steps of 1 second).

- The Interval setting is available only if the Record Method has been set to "Time".

- 5 Access Menu 232.

```

Log Setup 232
Record Method
Interval
▶Distance
0.01 mi
    
```

- 6 Select a Distance from 0.01 ~ 9.99 (in steps of 0.01).

- The Distance setting is available only if the Record Method has been set to "Distance".
- The unites used for Distance can be set to miles (mi), kilometers (km) or nautical miles (nm).

Interval and Log Total Time:

Point Q'ty	Interval time (second)					
	2	5	10	15	30	2800
5000	166.7	416.7	833.3	1250	2500	150000 (min)
	2.8	6.9	13.9	20.8	41.7	2500 (hour)

Interval and Total Distance:

Point Q'ty	Interval distance (km)					
	0.01	2.00	4.00	6.00	8.00	9.99
5000	50	10000	20000	30000	40000	49950 (km)

TARGET POINT

You can register positional information for a target point.

- 1 Enter Menu mode and access Menu 240.

```

Target Pt. 240
▶*1 JJ00AA
Name:
N 00°00.00'
W 000°00.00'
    
```

- 2 Select a Target Point (from 1 ~ 5).

- 3 Press [MHz]. The "in use" target point mark (**) appears to the left of the channel number.

- 4 Access Menu 241.

```

Target Pt. 241
1 JJ00AA
▶Name: ▶Oconeel_4
N 00°00.00'
W 000°00.00'
    
```

- 5 Enter a Target Point name (up to 8 characters).

- 6 Access Menu 242.

```

Target Pt. 242
*1 JM03AC
Name: Oconeel
▶N 33°07.15'
W 000°00.00'
    
```

<Menu No. 3W0: "dd°mm.mm" >

```

Target Pt. 242
*1 JM03AC
Name: Oconeel
▶N 33°07.15.0"
E 000°00.00.0"
    
```

<Menu 3W0: "dd°mm'ss.s" >

- 7 Enter the north/ south latitude.

- 8 Access Menu 243.

```

Target Pt. 243
*1 EM83KC
Name: Oconeel
▶N 33°07.15'
W 083°30.06'
    
```

<Menu No. 3W0: "dd°mm.mm" >

```

Target Pt. 243
*1 EM83KC
Name: Oconeel
▶N 33°07.15.0"
W 083°30.06.0"
    
```

<Menu 3W0: "dd°mm'ss.s" >

- 9 Enter the east/ west longitude.

MARK WAY POINT

You can register up to 100 points with the location's latitude, longitude, altitude, time, name, and icon. Names and icons can be manually edited.

- 1 When the frequency or position is displayed, press **[MARK] (1s)** to enter Mark Waypoint registration mode.
 - When registering a Mark Waypoint, the following display appears for approximately 10 seconds.

```
Marked !!
Edit > [OK]
```

- 2 Press **[▶OK]** to enter Mark Waypoint editing Mode.

```
1: MARK-1
▶Name
Icon
```

- 3 Selecting "Name" will enter the Name editing screen. You can enter up to 9 characters.

```
1: MARK-1
▶Name
▶Mark-1_ _ _ _ ◀
```

- 4 Selecting "Icon" will enter the Icon selection screen. Refer to the APRS explanation regarding the available icons.

```
1: MARK-1
▶ICON
▶Symbol : K W
Table : \ W
```

Note:

- ◆ Even when the Log function is OFF, you can register a Mark Waypoint.
 - ◆ The MCP-4A can read Mark Way points.
-

■ Copying the Mark Way Point to the Target Point

You can copy the displayed Mark Way Point to the Target Point.

- 1 Select "Copy to TP" to display the Target Point list.

```
1: MARK-1
▶COPY TO TP
```

- 2 Select the Target Point (1 ~ 5) that you want to copy.

```
<COPY TO TP>
▶Target Pt 1
Target Pt 2
```

■ Mark Way Point List

The information registered with the Mark Waypoint is confirmed.

Press **[MARK]** to display the Mark Waypoint list.

- The list of Mark way point appears.

```
▶ 1: KENWOOD
2: HOME
3: HAM store
```

- When there is no data registered in the Mark Waypoint, "No Mark" is displayed.
- Rotate the **Tuning** control: Selects the station data.
- Press **[▲]**: To move the cursor "▶" up the display, to the previous list number.
- Press **[▼]**: To move the cursor "▶" down the display, to the next list number.
- Press **[▶OK]**: Displays the details of the selected Mark Waypoint.
- Press **[A/B]**: Deletes the selected Mark Waypoint.
 - "Clear?" appears then press **[▶OK]** to clear.
- Press **[A/B] (1s)**: Deletes all Mark Waypoints.
 - "Clear All?" appears. Press **[▶OK]**, "Sure?" appears then press **[▶OK]** to clear all.
- Press **[MENU]**: Enters Mark Waypoint Edit mode.
- Press **[MARK]** or **[ESC ◀]**: Returns to the frequency display.

Note: When the Mark way point is no data registered, "No Mark" is displayed.

■ Detailed Display of a Mark Waypoint

The details of a Mark Waypoint are spread across 3 screen pages.

Page 1:

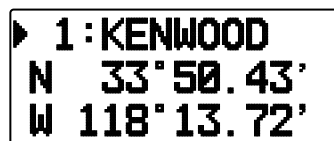

▶ 1:KENWOOD
N 33°50.43'
W 118°13.72'

- Rotate the **Tuning** control: Changes to the previous/next detailed display.
- Press [**ESC** ◀]: Returns to the Mark Waypoint list display.
- Press ▶**OK**]: Continues to the next page.
- Press [**A/B**]: Deletes the Mark Waypoint currently being displayed.
- Press [**MENU**]: Enters Mark Waypoint Edit mode.
- Press [**LIST**]: Returns to the frequency display.

Page 2:

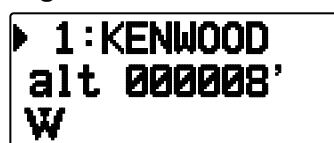

▶ 1:KENWOOD
alt 000008'
W

- Rotate the **Tuning** control: Changes to the previous/next detailed display.
- Press [**ESC** ◀]: Returns to the previous page.
- Press ▶**OK**]: Continues to the next page.
- Press [**A/B**]: Deletes the Mark Waypoint currently being displayed.
- Press [**MENU**]: Enters Mark Waypoint Edit mode.
- Press [**LIST**]: Returns to the frequency display.

Page 3:

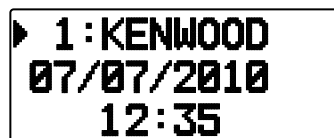

▶ 1:KENWOOD
07/07/2010
12:35

- Rotate the **Tuning** control: Changes to the previous/next detailed display.
- Press [**ESC** ◀]: Returns to the previous page.
- Press [**A/B**]: Deletes the Mark Waypoint currently being displayed.
- Press [**MENU**]: Enters Mark Waypoint Edit mode.
- Press [**LIST**]: Returns to the frequency display.

PACKET OPERATION

Connect this transceiver to your personal computer via a Terminal Node Controller (TNC). You can send messages or commands to far away stations, obtain a variety of information via your local bulletin boards, or enjoy other Packet applications. Reference material for starting Packet operation should be available at any store that handles Amateur Radio equipment.

Note: When the distance between the radio antenna and your personal computer is too close, interference may occur.

PACKET MODE

This transceiver has a built-in TNC which conforms to the AX.25 protocol. This protocol is used for communications between TNCs.

The baud rate of the PC (USB) port is 9600 bps for the PACKET mode operation.

For the commands supported by the built-in TNC, see "TNC COMMANDS LIST".

Press [TNC] 2 times to enter PACKET mode.

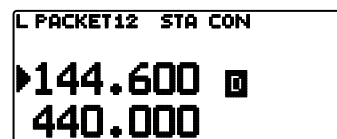

L PACKET12 STA CON
▶144.600 □
440.000

The following indicators appear on the transceiver display to show the current TNC status:

Indicator	Status
PACKET	The TNC is in Packet mode.
STA	Packets to be transmitted still remain in the buffer.
CON	The TNC is in connection with the target station.
12	1200 bps packet transfer rate selected.
96	9600 bps packet transfer rate selected. (To set it to 9600bps, use the HB 9600 (or HBAUD 9600) TNC command. This cannot be changed through the TH-D72 menu.)

Note:

- ◆ Not all functions available via conventional TNC's are supported by the TNC built in this transceiver.
- ◆ The built-in TNC could be automatically reinitiated when its malfunction is detected; this does not designate that the transceiver is defective.
- ◆ The internal TNC is a 2-chip type that does not have an SRAM backup. Therefore, the settings made using commands in Packet mode (except MYCALL (Menu.300: My Callsign will be set) and DAYTIME (Internal clock time will be set)) will be reset when the power is switched Off and then back On.
- ◆ The built-in TNC has 2k byte KISS mode data buffers for TX and RX.
- ◆ To distinguish your various stations or nodes, you can have up to 15 Secondary Station Identifiers (SSIDs); ex. W6DJY-1 to W6DJY-15. You always have to put a dash between your callsign and SSID number.
- ◆ Packet operation, easily affected by transmit and receive conditions, requires a full-scale S-meter reading for reliable communication. When the S-meter reads less than maximum during 9600 bps operation, communication errors are frequent.

DATA BAND

Select how data will be transmitted and received on your transceiver.

- 1 Enter Menu mode and access Menu 197.



Auxiliary 197
▶Packet Band
A:TX B:RX

- 2 Set the data band to "A-Band" (A band receives and transmits), "B-Band" (B band receives and transmits), "A: TX B:RX" (A band transmits (T:TX) and B band receives (R:RX)), or "A: RX B:TX" (A band receives (R:RX) and B band transmits (T:TX)).

TNC COMMANDS LIST

The commands supported by the built-in TNC are listed below. You must enter a space between a command name (or short-form) and a parameter, or between two parameters; ex. AU OFF, BEACON EVERY 18.

Command Name	Short	Description	Parameter	Default
AUTOLF	AU	When ON, sends a line feed (LF) to the computer after each carriage return (CR).	ON/ OFF	ON
AXDELAY	AXD	Specifies the delay time to be added to TXDELAY between PTT ON and start of transmission. The unit of the parameter is 10 milliseconds.	0 ~ 120	0
AXHANG	AXH	Specifies the voice repeater hang time. The unit of the parameter is 100 milliseconds.	0 ~ 250	0
BEACON	B	If set to EVERY, sends a beacon packet at intervals of the specified period (n). If set to AFTER, sends a beacon packet only once after the specified period (n). The unit of n is 10 seconds.	EVERY/ AFTER n (n = 0 ~ 250)	EVERY 0
BTEXT	BT	Specifies the content of the data portion of a beacon packet.	0 ~ 159 characters	-
CALIBRAT	CAL	Sends a space/mark square wave (50/50 ratio). Enter Q to exit Calibrate mode and restore the Command mode.	-	-
CHECK	CH	Specifies the interval from signal drop-out until execution of disconnection. The unit of the parameter is 10 seconds.	0 ~ 250	30
CMSG	CMS	When a connection is made, the message is automatically transmitted.	ON/ OFF	OFF
CMSGDISC	CMSGD	When a connection is made, it automatically disconnects.	ON/ OFF	OFF
CONMODE	CONM	With NOMODE set to OFF, causes the TNC to automatically enter Converse or Transparent mode when connection is completed.	CONVERSE/ TRANS	CONVERSE
CONNECT	C	Sends a connect request. Call is the callsign of the station to be connected to. VIA Call1 to call8 are callsigns of stations to be digipeated through.	Call (VIA call1, call2 ... call8)	-
CONOK	CONO	When ON, accepts a connect request and returns a UA packet. When OFF, rejects a connect request and returns a DM packet.	ON/ OFF	ON
CONSTAMP	CONS	When ON, displays the current date and time when connection is completed. The correct date and time must be set using DAYTIME.	ON/ OFF	OFF
CONVERSE	CONV or K	Causes the TNC to enter Converse mode. Press [Ctrl]+[C] to restore the Command mode.	-	-
CPACTIME	CP	When ON and in Converse mode, sends a packet at intervals of the period determined by PACTIME.	ON/ OFF	OFF
CR	CR	When ON, appends a carriage return (CR) to all packets to be sent.	ON/ OFF	ON
DAYSTAMP	DAYS	When ON, pressing [Ctrl]+[T] in Converse mode causes the TNC to send date data in addition to time data.	ON/ OFF	OFF
DAYTIME	DA	Sets the current date and time. Enter YYMMDDhhmmss. Sets 00 as the second if entry of the second is omitted.	-	-
DAYUSA	DAYU	When ON, displays the date like MM/DD/YY. When OFF, displays the date like DD-MM-YY.	ON/ OFF	ON
DIGIPEAT	DIG	When ON, allows the TNC to function as a digipeater.	ON/ OFF	ON
DISCONNE	D	Sends a disconnect request.	-	-

Command Name	Short	Description	Parameter	Default
DISPLAY	DISP	Causes the TNC to display the current status of all the commands. You can also specify a class identifier A, C, H, I, L, M, or T to display the status of only the desired command class. Enter a space between the command name and a class identifier; ex. DISPLAY H. A (ASYNC): RS-232C port parameters C (CHAR): Special TNC characters H (HEALTH): Counter parameters I (ID): ID parameters L (LINK): TNC-to-TNC link status M (MONITOR): Monitor parameters T (TIMING): Timing parameters	-	-
DWAIT	DW	Specifies the interval from no carrier detection until execution of transmission. The unit of the parameter is 10 milliseconds.	0 ~ 250	30
ECHO	E	When ON, causes the TNC to echo received characters to the computer.	ON/ OFF	ON
EPATH	EPATH	Specifies digipeater callsigns to be added when the UISSID parameter in a received packet is 10 or 14.	Call1, ... call7	-
FLOVER	FL	Specifies the time delay from when the TNC buffer becomes full until the TNC buffer is cleared. The unit of the parameter is 1 minute.	0 ~ 120	0
FLOW	F	When ON, starting key entry causes the computer to stop displaying received packets.	ON/ OFF	ON
FRACK	FR	Specifies the interval from one transmission until retry of transmission. The unit of the parameter is 1 second.	0 ~ 15	3
FULLDUP	FU	When ON, allows the TNC to function in full duplex. When OFF, allows it to use data carrier detect signals to avoid packet collision.	ON/ OFF	OFF
GBAUD	GB	Selects 2400, 4800 or 9600 bps as the transfer rate between the TNC and the GPS receiver.	2400/ 4800/ 9600	4800
GPSFILT1	GPSFILT1	Filter setting of the GPS input data.	0 ~ 6 characters	-
GPSFILT2	GPSFILT2	Filter setting of the GPS input data.	0 ~ 6 characters	-
GPSFILT3	GPSFILT3	Filter setting of the GPS input data.	0 ~ 6 characters	-
GPSFILT4	GPSFILT4	Filter setting of the GPS input data.	0 ~ 6 characters	-
GPSEND	GPSS	Specifies the content of data to be output to the GPS receiver; this data is used to program the default settings on the receiver. The output data is not stored in memory.	0 ~ 32 characters (recommended)	-
GPSTEXT	GPST	Specifies the type of a message to be determined by LTEXT.	0 ~ 6 characters	\$PNTS
HBAUD	HB	Selects 1200 or 9600 bps as the transfer rate between packet stations.	1200/ 9600	1200
HEALLED	HEAL	Determines whether or not normal operations of the ROM are checked. When ON and if normal operations are detected, "STA" and "CON" appear and blink alternately.	ON/ OFF	OFF
HID	HI	When ON, causes the TNC to send an ID packet every 9.5 minutes after digipeating.	ON/ OFF	ON
ID	I	Causes the TNC to send an ID packet.	-	-
KISS	KISS	When ON, entering a RESTART command causes the TNC to enter (or exit) KISS mode.	ON/ OFF	OFF

Command Name	Short	Description	Parameter	Default
LOCATION	LOC	If set to EVERY, sends GPS data at intervals of the specified period (n). If set to AFTER, sends GPS data only once after the specified period (n). The unit of n is 10 seconds.	EVERY/ AFTER n (n = 0 ~ 250)	EVERY 0
LPATH	LPA	Specifies callsigns to send GPS data. Call1 is the callsign of the destination. Call2 to call8 are callsigns of stations to be digipeated through.	Call (VIA call1, call2, ... call8)	GPS
LTEXT	LT	Specifies the content of a message to be included in GPS data.	0 ~ 159 characters	-
LTMON	LTM	Specifies the interval for displaying a message determined by LTEXT on the screen; a message appears like a received beacon packet. The unit of the parameter is 1 second.	0 ~ 250	0
MALL	MA	When ON, all stations is monitored. When OFF, only the station which transmitted and has not yet connected with the packet is monitored.	ON/ OFF	ON
MAXFRAME	MAX	Specifies the maximum number of packets to be transmitted at one time.	1 (fixexd value)	1
MCOM	MCOM	When ON, causes the TNC to also monitor control packets. When OFF, causes it to monitor only information packets.	ON/ OFF	OFF
MCON	MC	When ON, causes the TNC to monitor other stations while in connection with the target station.	ON/ OFF	OFF
MONITOR	M	When ON, causes the TNC to monitor packets.	ON/ OFF	ON
MRPT	MR	When ON, causes the TNC to display the entire digipeat list for monitored packets.	ON/ OFF	ON
MSTAMP	MS	When ON, causes the TNC to display data and time information for monitored packets.	ON/ OFF	OFF
MYALIAS	MYA	Specifies a callsign for using your station as a digipeater.	6 characters + SSID	-
MYCALL	MY	Specifies your callsign.	6 characters + SSID	-
NEWMODE	NE	When ON, entering a CONNECT command causes the TNC to immediately enter the other mode.	ON/ OFF	OFF
NOMODE	NO	When ON, does not cause the TNC to automatically enter the other mode. When OFF, causes it to automatically enter the other mode as specified by NEWMODE.	ON/ OFF	OFF
NPATH	NPATH	Specifies digipeater callsigns to be added when the UISSID parameter in a received packet is 8 or 12.	Call1, ... call7	-
NTSGRP	NTSGRP	Specifies a group code to be used for making a \$PNTS sentence.	0 ~ 3 characters	-
NTSMRK	NTSMRK	Specifies a mark number to be used for making a \$PNTS sentence.	0 ~ 14	0
NTSMMSG	NTSMMSG	Specifies a message to be used for making a \$PNTS sentence.	0 ~ 20 characters	-
PACLEN	P	Specifies the maximum length of the data portion of a packet.	0 ~ 255	128
PACTIME	PACT	If set to EVERY, sends a packet at intervals of the specified period (n). If set to AFTER, sends a packet only once after the specified period (n). The unit of n is 100 milliseconds.	EVERY/ AFTER n (n = 0 ~ 250)	AFTER 10

Command Name	Short	Description	Parameter	Default
PASSALL	PASSA	When ON, only the frame for which an error has been detected is accepted. When OFF, only correct frames are accepted; frames for which an error has been detected are canceled.	ON/ OFF	OFF
PERSIST	PE	Specifies a parameter to calculate probability for the PERSIST/SLOTTIME method.	0 ~ 255	128
PPERSIST	PP	Causes the TNC to use the PERSIST/SLOTTIME method when ON, or the DWAIT method when OFF.	ON/ OFF	ON
RESET	RESET	Restores the default status for all the commands.	-	-
RESPTIME	RES	Specifies the acknowledgment packet transmission delay. The unit of the parameter is 100 milliseconds.	0 ~ 250	0
RESTART	RESTART	Causes the TNC to function as if it is switched OFF then ON.	-	-
RETRY	RE	Specifies the number of transmission retries.	0 ~ 15	10
SENDPAC	SE	Specifies a character which forces a packet to be sent.	0 ~ \$7F	\$0D
SLOTTIME	SL	Specifies the period of random number generation intervals for the PERSIST/SLOTTIME method. The unit of the parameter is 10 milliseconds.	0 ~ 250	3
SPATH	SPATH	Specifies digipeater callsigns to be added when the UISSID parameter in a received packet is 9 or 13.	Call1, ... call7	-
TRACE	TRAC	When ON, causes the TNC to display all received packets in their entirety.	ON/ OFF	OFF
TRANS	T	Causes the TNC to exit Command mode and enter Transparent mode. To restore Command mode, press and hold [Ctrl], then press [C] three times.	-	-
TRIES	TRI	Specifies the number of transmission retries programmed in the retry counter.	0 ~ 15	0
TXDELAY	TX	Specifies the time delay between PTT ON and start of transmission. The unit of the parameter is 10 milliseconds.	0 ~ 120	30
UICHECK	UIC	Does not forward the same UI packet as one received within the time specified by this command. The unit of the parameter is 1 second.	0 ~ 250	28
UIDIGI	UI	When receiving a UI packet which includes the parameter specified by this command, replaces the parameter with the MYCALL parameter and forwards the packet.	ON/ OFF, Call1, ... call4	OFF
UIDWAIT	UIDW	When ON and digipeating, causes the TNC to use the DWAIT and PPERSIST settings.	ON/ OFF	OFF
UIFLOOD	UIF	Specifies how received UI packets, which include WIDEN-N or TRACEN-N parameters, are processed. Enter WIDE or TRACE before ID, NOID, or FIRST; ex. WIDE,FIRST. With ID selected, deletes the relayed digipeaters and adds the MYCALL parameter. With NOID, merely decrements N-N; ex. 4-3 to 4-2. With FIRST, adds the MYCALL parameter only when serving as the first digipeater.	Name, ID/ NOID/ FIRST	-
UISSID	UIS	When ON, causes the TNC to process received UI packets depending on included destination SSIDs.	ON/ OFF	OFF
UITRACE	UIT	The command name must be followed by up to 5 alphanumeric characters; normally WIDE or TRACE. Causes the TNC to forward received UI packets which include WIDEN-N or TRACEN-N parameters.	Name	-

Command Name	Short	Description	Parameter	Default
UNPROTO	U	Specifies callsigns to send a packet in Unprotocol mode. Call1 is the callsign of the destination. Call2 to call8 are callsigns of stations to be digipeated through.	Call (VIA call1, call2,... call8	CQ
VERSION	VER	Version display inquiry.		
WPATH	WPATH	Setting for changing the relay exchange list when relaying with UISSID.	Call1, ... call7	-
XFLOW	X	Causes the TNC to perform software flow control when ON, or hardware flow control when OFF.	ON/ OFF	OFF

APRS DATA COMMUNICATION (APRS BEACON)

- ◆ This function uses the APRS format for data communications including your station position, messages, etc..
- ◆ When data is received from another station, the direction of the received station (from your station's perspective), their distance, and their grid square locator is displayed. Any comments sent by the other station are also displayed.
- ◆ Meteorological data obtained from a connected Weather Station can be transmitted.
- ◆ APRS (Automatic Packet Reporting System) is a worldwide system introduced by Bob Bruninga, WB4APR .

< APRS® is a software program and registered trademark of Bob Bruninga, WB4APR.>
 Official APRS Website: <http://www.aprs.org>

NAVITRA DATA COMMUNICATION (NAVITRA BEACON)

- ◆ The Navitra system was introduced by Kenwood in the 1990's, for use within Japan.

CALLSIGN AND BEACON TYPE SETTINGS

- ◆ When an APRS/NAVITRA beacon is created, set the s and beacon type (APRS/NAVITRA) (Menu 301).



- ◆ SSID (Secondary Station IDentifiers) can be added to the end of your callsign (for example, W6DJY will become W6DJY-14). SSIDs can range from "None, - 1" to "- 15", so that each callsign can have up to 16 settings.

Refer to the website for SSID: <http://aprs.org/aprs11/SSIDs.txt> (as of November 2011)

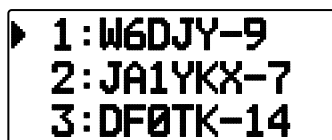

DIGIPEAT

- ◆ The term digipeat means that the packet data is relayed. When a digipeater (relay station) receives a packet, it saves it to memory. When the reception ends, the data is re-transmitted. Using digipeat, it is possible to send beacons long distances.
- ◆ In order to perform a digipeat, you must set up a packet path (Menu 3H0). For the packet path, you can specify a direct callsign or you can use "WIDE1-1" or "WIDE1-1, WIDE2-1", specifying a common alias and hops number. Set the transceiver's packet path according to the digipeater settings.
- ◆ Digipeat is very useful in reaching other stations when you have a weak signal. However, you need to set up the total hops numbers and beacon transmissions moderately to prevent channel congestion.

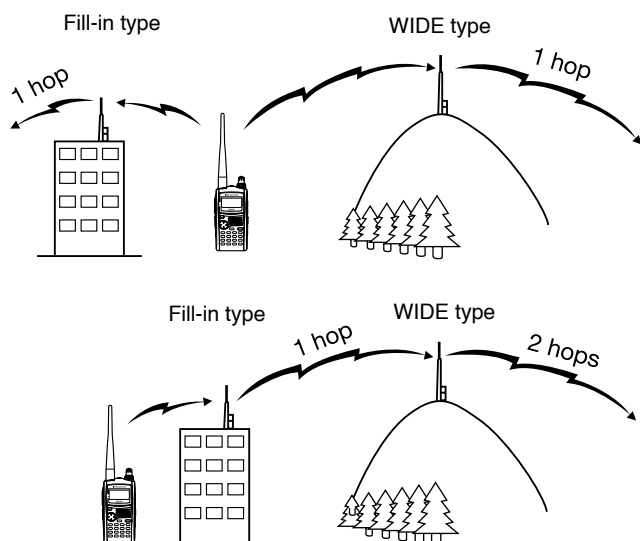

WIDE type:

This digipeater can send the packet over a wide area.

Fill-in type:

Regional digipeaters are also called "RELAY type" relays. These digipeaters are used for mobile stations when a signal cannot reach a WIDE-type digipeater.

Note: While using APRS, in order to prevent Packet miss-decoding, access Menu No. 110 and set the Battery Saver to "Off" or "0.03".

CONNECTING TO AN EXTERNAL GPS UNIT OR WEATHER STATION

The COM terminal on this transceiver accepts a 2.5 mm (1/10") 3-conductor plug. If necessary, use the cable (service part: E30-3400-XX) to modify the cable end of external GPS receiver or Weather Station.

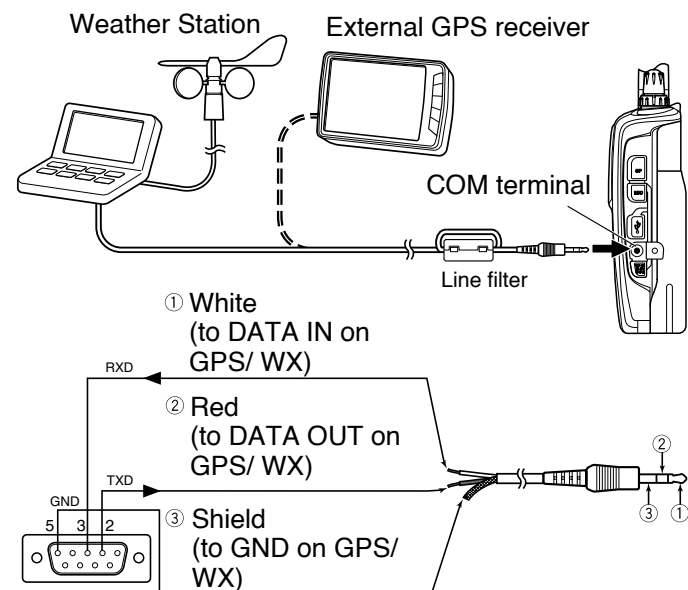

- Attach the line filter to the cable.
- Use a GPS receiver which conforms to the NMEA-0183 format and is compatible with RS-232C signal polarity output at the below mentioned levels.
[Low level: less than +0.5 V / High level: more than +3 V]
You cannot use GPS receivers with USB-type connections.
- Depending on the specifications of the equipment you are connecting, it may be necessary to connect pins 4 and 6, and pins 7 and 8, on the 9-pin D-SUB connector.

ADJUSTING THE INTERNAL CLOCK

When the internal GPS function is turned ON, the year, month, day, and time are automatically set from the GPS satellite information. If the GPS information cannot be received, you can manually enter the date and time.

Note: The battery for the clock backup is built into the unit. When the battery pack is connected, the backup battery begins to charge. It takes approximately 8 hours to become fully charged.

Setting Date

- 1 Access Menu 194.
 - The first 2 digits blink.

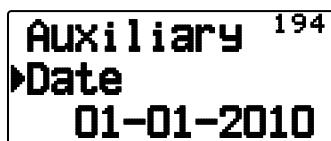

- 2 Press [▲]/[▼] or rotate the **Tuning** control to enter the current month (TH-D72A) or day (TH-D72E), then press [▶OK].
 - The next 2 digits blink.

- 3 Press [▲]/[▼] or rotate the **Tuning** control to enter the current day (TH-D72A) or month (TH-D72E), then press [▶OK].
 - The last 2 digits blink.
- 4 Press [▲]/[▼] or rotate the **Tuning** control to enter the current year, then press [▶OK].
- 5 Press [ESC ◀] to exit Menu mode.

Note:

- ◆ When used at room temperature (25°C), the error of the internal clock in a month is within one minute.
- ◆ The internal clock is effective until December 31, 2099.

Setting Time

- 1 Access Menu 195.
 - The first 2 digits blink.

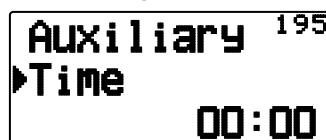

- 2 Press [▲]/[▼] or rotate the **Tuning** control to enter the current hour, then press [▶OK].
 - To set 1 o'clock PM for example, select 13.
 - The next 2 digits blink.
- 3 Press [▲]/[▼] or rotate the **Tuning** control to enter the current minute, then press [▶OK].
- 4 Press [ESC ◀] to exit Menu mode.

Setting UTC Offset

- 1 Access Menu 196.

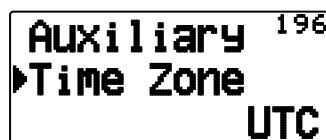

- 2 Press [▲]/[▼] or rotate the **Tuning** control to select the appropriate UTC offset, then press [▶OK].
 - The selectable range is from +14:00 to -14:00 in steps of 15 minutes.
- 3 Press [ESC ◀] to exit Menu mode.

RECEIVING APRS DATA

Each time a new APRS packet is received, the frequency display is interrupted to show information as below:

```
▶W6DJY-9
  Enroute to
  🚗 hamfest.
```

- The received APRS packet may include information on an object such as a hurricane or tornado. In this case (ex. object), the name of the object appears instead of a callsign.
- To restore the frequency display, press **any key** or just wait for approximately 10 seconds. (You can change the time through Menu No. 3U1(Interrupt Time).)

Note:

- ◆ When you receive an APRS packet including an "Emergency" comment, a different format of display from the above will appear and a different beep will sound.
- ◆ When you receive an APRS position packet that you transmitted, the frequency display is interrupted and "My Position" will appear on the display. This could happen when one or more digipeaters are used. (When setting Menu No. 3U0 (Display Area) to "Entire Disp", or "One Line", the call sign of the digipeater station will not display.)

```
My Position
  Via
  W6DJY-1
```

- ◆ If you receive a message that you transmitted, "My Message" will appear.
- You can change the interrupt screen display setting through Menu No. 3U0 (Display Area). When set to "One Line", the frequency display is not interrupted. An indicator such as "dP" appears depending on the types of data. Refer to the table.

```
dP W6DJY-9
▶144.390 📍
  438.350
```

Indicator	Meaning
dP	Duplicate position comment
nP	New position data
oP	Other station position data (Navitra beacon)
>P	Beyond position limit
>F	Beyond filter type
aM	ACK message
dM	Duplicate message data
nM	New message data
oM	To other stations message data
rM	Rejected Message
dS	Duplicate status text
nS	New status
Q?	Query
??	Packet that cannot be decoded
dD	Duplicated DX cluster data
nD	New DX cluster data

Note:

- ◆ The APRS programs for PCs have entry fields for a position comment and status text. The data entered to these two fields are transmitted as separate packets. This transceiver, however, includes both of a position comment and status text in one packet to transmit.

- ◆ This transceiver beeps each time it receives any type of APRS packet. You may access Menu 3TO (Sound - RX Beep) to change this setting. The default is "All".

ACCESSING RECEIVED APRS DATA

This transceiver is capable of receiving and storing APRS data received from up to 100 stations in memory. You can easily recall the information of the desired station.

1 Press [LIST].

- The list of stations appears.
- The numbers beside the callsigns indicate the order in which data is received. The data received last is assigned 1.

```
▶ 1:W6DJY-9
  2:JA1YKX-7
  3:DF0TK-14
```

2 Press [LIST] (1s) to change the List type to [Callsign + model name], [Callsign + Time + QSY].

```
-STATION LIST-
▶ 1:W6DJY-9 TMD710
  2:JA1YKX-7 TH-D72
  3:DF0TK-14 TMD710
  4:W5DJY FIXED
  5:9U1KW-13 WX
```

```
-STATION LIST-
▶ 1:W6DJY-9 15:08F
  2:JA1YKX-7 15:01F
  3:DF0TK-14 14:55
  4:W5DJY 14:52
  5:9U1KW-13 14:49
```

- Press [▼]: To move the cursor "▶" to big list number (Old receiving station).
- Press [▲]: To move the cursor "▶" to small list number (New receiving station).
- Press [ESC ◀]: Return to the frequency display.
- Press [A/B]: Deletes the selected station.
 - "Clear?" appears then press [▶OK] to clear.
- Press [A/B] (1s): Deletes all stations.
 - "Clear All?" appears. Press [▶OK], "Sure?" appears then press [▶OK] to clear all.
- Press [MENU]: To enter the station list menu.

2 Press [▲/▼] to select the desired station using the cursor (⬆).

3 Press [▶OK].

- The information of the selected station appears.

```
▶ 2:JA1YKX-7
  TH-D72
  🚗 In Service
```

- Press [▶OK]: Displays the next page.
- Press [ESC ◀]: Displays the previous page.
- Press [A/B]: Deletes the current station.
- Press [MENU]: To enter the station list menu.

Note:

- ◆ When data from the 101st station is received, the oldest data in memory is replaced by that data.
- ◆ Each time a new APRS packet is received from the same station, the old data from that station (in memory) is replaced by new data.

DISPLAY EXAMPLE

Page 1 :



- ① Callsign
- ② Situation
- ③ Station icon
- ④ Position comment¹

¹ For packets received from Mic-encoder stations including TM-D710s, TM-D700s, TH-D72s, and TH-D7s, position comments are displayed in the fourth line.

(Object)



- ① Object

Page 2:

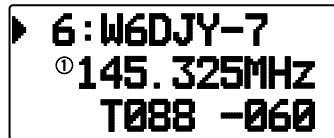

- ① Status text

Page 3:

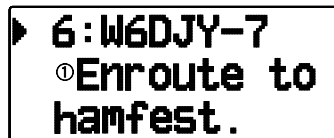

- ① Status text

Page 4:

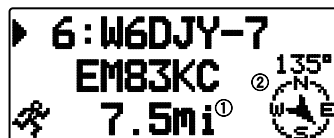

- ① Distance from station (mile or km)
- ② Direction of station

• When pressing [F] while the target point distance/traveling direction is displayed, the North Up display (displays North as the top) changes to the Heading Up display (displays the current travel direction as the top) or vice-versa. In the Heading Up display, a "+" or "-" is used to help indicate the traveling direction.



Page 5:

(Mobile station)

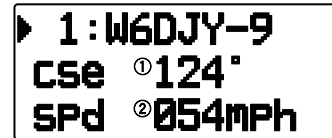

- ① Moving direction
 - ② Moving speed (mph: Mile/hour or km/h: km/hour)
- (Weather station)



- ① Rainfall (" or mm)
- ② Air temperature
- ③ Wind direction

(Fix station)



- ① Transmit power
- ② Height of antenna (elevation) (' : Feet or m: Meter)

Page 6:

(Mobile station)

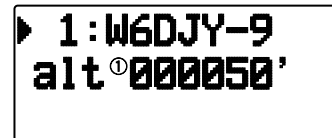

- ① Altitude (' :Feet or M: Meter)

(Weather station)



- ① Wind velocity (mph: Mile/hour or km/h: km/hour)
- ② Atmospheric pressure
- ③ Humidity

(Fix station)

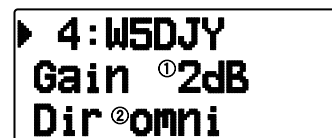

- ① Antenna gain
- ② Antenna directivity

Page 7:

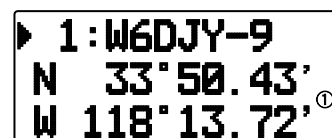

- ① Position data

Page 8:

(Packet path)

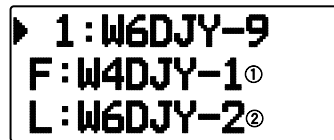

- ① F: First Repeat (Degipeater) Station's callsign
- ② L: Last Repeat (Degipeater) Station's callsign

Page 9:

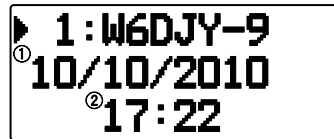

- ① Receive date
- ② Receive time

This transceiver is capable of displaying the following icons as station IDs.

<APRS>



<NAVITRA>



Some icons may appear with overlay characters as below if the received icon data includes them (APRS only).

Example:



The following icons show the directions of stations relative to your position.

(North Up)



(Heading Up: example)



To change the speed/distance and/or temperature settings of the units, access Menu 3V0 (Units 1 - Speed/ Distance) and/or Menu 3V2 (Units 1 - Temperature).

Note: Some stations transmit APRS packets through TNCs connected to GPS receivers. If you receive packets from those stations, "GOOD" (satellites tracked) or "LAST" (satellites not tracked) will be shown as the situation, with GLL, GGA, or RMC which designates \$GPGLL, \$GPGGA, or \$GPRMC format.

SORT FUNCTION

This function allows you to sort the station list according to the callsign, date time, or distance.

- 1 Press [LIST] and display the list of stations.

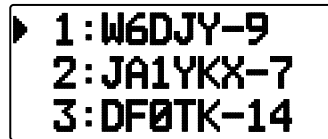

- 2 Press [MENU] and display the station list menu.



- 3 Press [▲]/[▼] or rotate the Tuning control to select [Sort], then press [▶OK].



- The sort type list appears on the display.



- 4 Press [▲]/[▼] or rotate the Tuning control to select a sort type, then press [▶OK].

- "Sorting!" appears on the display and sorting begins.

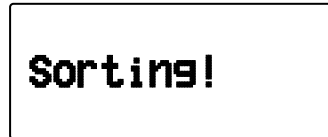

Callsign	All callsigns are compared and arranged in ascending order.
Date/Time	All received dates and times are compared and arranged in descending order, with the last received message listed first.
Distance	The distance between the other station and My station when selecting the sorting method is calculated, then compared and arranged in ascending order, with the closest station listed first.

- 5 The newly sorted station list appears on the display.

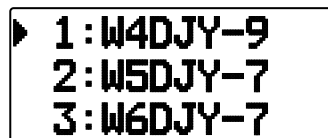

- After sorting, when new station data is received, it is added to the station list without resorting.

DISPLAY FILTER FUNCTION

This function allows you to display only the specified types of data from the station list.

- 1 Press [LIST] and display the list of stations.

```
▶ 1:W6DJY-9
  2:JA1YKX-7
  3:DF0TK-14
```

- 2 Press [MENU] and display the station list menu.

```
1:W6DJY-9
▶Tune
Sort
```

- 3 Press [▼] or rotate the **Tuning** control to select [Filter], then press [▶OK].

```
1:W6DJY-9
▶Filter
```

- The filter type list appears on the display.

```
<Filter>
▶Weather
Mobile
```

- 4 Press [▲]/[▼] or rotate the **Tuning** control to select a filter type, then press [▶OK].

- “Filtering” appears on the display and filtering begins.

```
Filtering!
```

All(Off)	The filtering function is cancelled, displaying all stations.
Digipeater	Only Digipeater Stations are displayed.
Weather	Only Weather Stations are displayed.
Mobile	Only Mobile Stations are displayed.
Object	Only Object Stations are displayed.
KENWOOD	Only Kenwood TH-D72, TH-D7, TM-D700, TM-D710, and RC-D710 Stations are displayed.
NAVITRA	Only Navitra Stations starting from \$PNTS are displayed.
QSY (Freq)	Only stations containing frequency (QSY) data are displayed.
1-Way	Only the message incapable MicEncoder format stations and the GPS trackers are displayed.
Others	Stations other than those listed above are displayed.

- 5 The newly filtered station list appears on the display.

```
▶ 1:9U1KW-13
  2:W6DJY-13
```

- After the display filter function is turned ON, received data is added to the list but will not be displayed if it matches the filter type selected.
- For example, with the station list displayed and the display filter selection set to “Weather”, all stations not relating to weather are no longer displayed. If mobile station data is received at this time, the new data will also not be displayed as long as the weather filter is active.

RECEIVING A MESSAGE

Each time a proper message is received, the frequency display is interrupted to show information as below:

First page:

```
① ② ③ ④
*⑤→W6DJY-7
⑥I will leave
home soon.
```

Last page:

```
*①→W6DJY-7
⑥05/12 ⑦17:22
Line# ⑧12345
```

- ① Status Indicator
- ② Meaning Indicator
- ③ RX or TX Indicator
- ④ Callsign (TX)
- ⑤ Message
- ⑥ TX/RX date
- ⑦ Receive time
- ⑧ Line number

- The display shows up to 67 characters (24 characters by one page) of the message.

- The following indicators appear depending on the types of received messages:

① Status	
n ¹	“n” indicates the remaining number of times for transmitting the message (or bulletin).
* ¹	A message for which a reception acknowledgment was returned
. ¹	A message (or bulletin) transmitted 5 times (For a message, a reception acknowledgment was not returned.)
② Meaning	
Ⓛ	Message addressed to you
B	Bulletin message
!	Report by the National Weather Service
③ RX or TX	
←	Received message (or bulletin)
→	A message (or bulletin) for transmitting

- ¹ These indicators appear for outgoing messages (or bulletins).

- When a duplicate message from the same station is received, the reception interrupt display does not appear and an error tone sounds. When the frequency at that time appears on the display, "dM" (duplicate Message) and the calling station's callsign appears on the display.

```

dM W6DJY-9
▶144.390 □
440.000

```

Note:

- ◆ This transceiver allows you to receive a message also when the SSID does not match. However, it will not return a reception acknowledgment.
- ◆ The dedicated memory is used for storing both incoming and outgoing messages. Receiving a new message when the memory is full causes the oldest message to be deleted. A message not yet transmitted 5 times may be unexpectedly deleted. If the oldest message has not been accessed using the List function when memory is full, a new message does not replace the oldest message. This transceiver will return a reject command and display "rM".
- ◆ This transceiver beeps each time it receives any type of APRS packet. You may access Menu 3N0 (Sound-RX Beep) to change this setting. The default is "All".

ENTERING A MESSAGE

To transmit a message, first enter the callsign of the target station. To transmit a bulletin, enter "BLN#" instead; where # must be 0 to 9 or A to Z. When the length of your bulletin exceeds 64 digits, you may transmit more than one packet to send the entire bulletin. Use # to indicate the sequence of the bulletin portions. For example, enter "BLN0" (or "BLNA") to send the first packet, then "BLN1" (or "BLNB") to send the second packet.

- 1 Press [MSG].
 - The message list appears on the display.

```

▶1+W6DJY-9
2BW6DJY-7
3+W4DJY-9

```

- 2 Press [MENU].
 - The message list menu appears on the display.

```

1+W6DJY-9
▶Reply
Edit

```

- 3 Press [▲]/[▼] or rotate the **Tuning** control to select [New], [Edit] or [Reply].

```

1+W6DJY-9
Edit
▶New

```

- The display for entering a callsign appears; the first digit blinks. (When you press [Edit] or [Reply], not necessarily)

```

MSG Input
▶To: ■■■■■■■■■■

```

- When selecting [Edit], the original message is quoted and you can then edit it.

- 4 Press [▲]/[▼] or rotate the **Tuning** control to select the first digit.
 - You can enter 0 to 9, A to Z, and –.

- 5 Press [▶OK].
 - The cursor moves to the next digit.
 - Press [ESC ◀]: Causes the cursor to move backward.
 - Press [A/B]: Deletes the digit at which the cursor is blinking.

- 6 Press [▲]/[▼] or rotate the **Tuning** control then press [▶OK] to complete the setting.
 - The display for entering a message appears; the first digit blinks.

```

MSG Input
▶To: W6DJY-7
▶■■■■■■■■■■

```

Press [ESC ◀]: Causes the cursor to move backward.

Press [A/B]: Deletes the digit at which the cursor is blinking.

- To copy a message, enter message compilation mode, press [F] to enter function mode, then press [1] (Paste 1), [2] (Paste 2), [3] (Paste 3), [4] (Paste 4), [5] (Paste 5), [6] (Paste 6), [7] (Paste 7), or [8] (Paste 8) key for 1 second to copy the message that has been set up for each key.

```

Phrase Paste
▶1: Good morni
2: Good after

```

- 7 Press [▲]/[▼] or rotate the **Tuning** control to select the first digit.
 - You can enter alphanumeric characters plus special ASCII characters.

- 8 Press [▶OK].
 - The cursor moves to the next digit.

- 9 Repeat steps 6 and 8 to enter up to 67 digits.

- 10 Press [▶OK] to complete the setting.

TRANSMITTING A MESSAGE

- 1 Press [MSG].
 - The message list appears on the display.
- 2 Press [MENU].
 - The message list menu appears on the display.
- 3 Press [▲]/[▼] or rotate the **Tuning** control to select [Send].

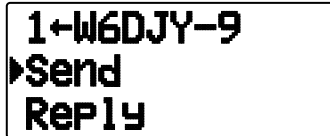

```
1+W6DJY-9
▶Send
Reply
```

- 4 Press [▶OK] to send the message.

You can select the follows item other then [Send], [Reply], [Edit], [New] in message list menu.

Re-TX: Sending the message again.

Position: Search position information from a position list.

POS Request: The position data of the transmitting station is displayed (if the station data is available).

Unread: Change the existing reading message to unread message.

ACCESSING RECEIVED APRS MESSAGES

This transceiver is capable of storing a maximum of 100 messages in memory. You can easily access one of those.

- 1 Press [MSG].
 - The message list appears on the display.

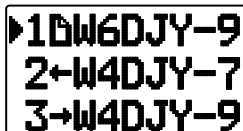

```
▶1+W6DJY-9
2+W4DJY-7
3+W4DJY-9
```

- The newer message the smaller number assigned; the latest message is assigned 1.
- 2 Press [▲]/[▼] or rotate the **Tuning** control to select the desired message using the cursor (▶).
 - Press [ESC◀] or [PTT]: Re tun to the frequency display.
 - Press [MSG]: Makes the Reply message.
 - Press [POS]: Displays the detailed data of the message transmit station.
 - Press [A/B]: Deletes the selected message.
 - "Clear?" appears then press [▶OK] to clear.
 - Press [A/B] (1s): Deletes all messages.
 - "Clear All?" appears. Press [▶OK], "Sure?" appears then press [▶OK] to clear all.
 - 3 Press [▶OK].
 - If you select an incoming message, the following display appears:

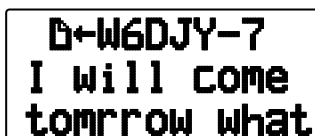

```
1+W6DJY-7
I will come
tomorrow what
```

- Rotate the **Tuning** control: Scrolls the message.

- Press [ESC◀]: Re tun to the message list.
- Press [▶OK]: Displays the next page.
- Press [MSG]: Responds to the party from whom you received. Enters into message setting.
- Press [A/B]: Deletes the selected message.
- Press [PTT]: Re tun to the frequency display.
- Press [POS]: If position data is available within the station list, it will be displayed while the current message of the transmitting station is displayed.

- If you select last page, the following display appears (Sended date/ time/ line number):

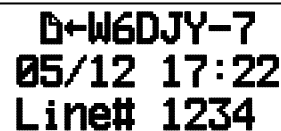

```
1+W6DJY-7
05/12 17:22
Line# 1234
```

- If you select one of your outgoing messages, the following display appears:



```
*1+W6DJY-9
I'm free thi
s afternoon
```

- Rotate the **Tuning** control: Scrolls the message.
- Press [ESC◀]: Re tun to the message list.
- Press [▶OK]: Displays the next page.
- Press [MSG]: Responds to the party from whom you received. Enters into message setting.
- Press [A/B]: Makes the transmitted message.
- Press [PTT]: Re tun to the frequency display.
- Press [POS]: If position data is available within the station list, it will be displayed while the current message of the transmitting station is displayed.

BASIC SETTINGS

■ My Callsign

Program your callsign using a maximum of 9 alphanumeric characters. You may include SSID characters in the string. Unless you program a callsign, you cannot transmit APRS packets.

- 1 Access Menu 300.



```
Basic Set 300
▶ My Callsign
  Beacon Type
  APRS Lock
    ▶ W6DJY-9
```

- The display for entering a callsign appears; the first digit blinks. The default is “NOCALL”.
- 2 Press [**▲**]/[**▼**] or rotate the **Tuning** control to select the first digit.
 - You can enter 0 to 9, A to Z, and –.
 - 3 Press [**▶OK**].
 - The cursor moves to the next digit.
 - 4 Repeat steps 2 and 3 to enter up to 9 digits.

■ Beacon Type

Access Menu 301.



```
Basic Set 301
My Callsign
▶ Beacon Type
  APRS Lock
    APRS
```

APRS: Beacons are transmitted in APRS format when the “APRS” icon appears on the upper left of the display. Additionally, in Menu mode, only those menus which can be set with APRS are displayed.

NAVITRA: Beacons are transmitted in NAVITRA format when the “NAVITRA” icon appears on the upper left of the display. Additionally, in Menu mode, only those menus which can be set with NAVITRA are displayed.

■ APRS Lock

This function prevents accidentally changing the built-in data band frequency or accidentally transmitting on the data band by pressing [**PTT**].

The “APRS lock” appears when APRS lock is activated.

Access Menu 302.



```
Basic Set 302
My Callsign
  Beacon Type
  ▶ APRS Lock
    On
```

On: The frequency of the built-in data band cannot be changed.

(You also cannot perform Scan with [**VFO**], [**MR**], [**ENT**], [**MHz**], or the **Tuning** control.)

On & PTT: The frequency of the built-in data band cannot be changed. You cannot transmit on the data band by pressing [**PTT**].

On & TNC: The frequency of the built-in data band cannot be changed. While in APRS mode, pressing [**TNC**] will not exit APRS mode.

On & PTT & TNC: The frequency of the built-in data band cannot be changed. You cannot transmit on the data band by pressing [**PTT**]. While in APRS mode, pressing [**TNC**] will not exit APRS mode.

- When the data band is set as the cross band, both band frequencies cannot be changed and you cannot transmit using [**PTT**].
- During APRS lock, you cannot change the CTCSS/DCS setting of the data band.
- During APRS lock, you cannot change the DUAL setting of the non-data band.

Off: Changes the internal Data Band frequency so that you can transmit on the internal Data Band by pressing [**PTT**].

SETTING INTERNAL TNC

■ Data Band

Access Menu 310.

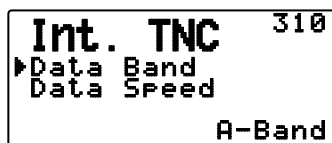

On this transceiver you can select data band for APRS mode independent of the selection for Packet mode. Select band A or B as the data band for receiving or transmitting APRS packets. The default is band A. "A" indicates the current data band.

Note: In Menu 310, the selection switches among A-Band, B-Band, A:TX B:RX, and A:RX B:TX. Select A:TX B:RX or A:RX B:TX if APRS networks which use two separate frequencies become available in the future.

■ Packet Transfer Rate

Access Menu 311.

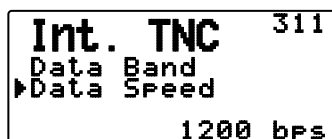

The default APRS packet transfer rate set on the built-in TNC is 1200 bps which is the standard among the current APRS networks.

Note: You can also set the Packet transfer rate to 9600bps when necessary.

■ DCD Sense

Access Menu 320.



You can also select the method for inhibiting the built-in TNC from transmitting.

D or RxD Band: When the data band is no longer busy (as per the steps below), the packet is transmitted.

- ① Press [PTT] to enter transmit mode.
- ② The data band is busy.

Both Band: When the bands are no longer busy (as per the steps below), the packet is transmitted.

- ① Press [PTT] to enter transmit mode.
- ② The data band is busy.
- ③ The other band is busy.

Ignore DCD: Transmission from the built-in TNC is not inhibited. The packet is transmitted immediately.

■ TX delay time

Access Menu 321.

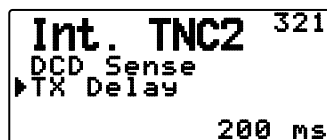

This function allows you to set a transmission delay time between transmitting the APRS data and transmitting a flag code prior to the APRS data. When the other station has activated their Save Mode, set a longer delay time.

SETTING COM PORT

■ Baud Rate

Access Menu 330.



Set the communication speed of the external GPS or other equipment that is connected to the GPS terminal. The speed is set to 4800 bps (NMEA)/ 9600 bps (IPS format: SONY) when a GPS receiver is connected.

- It does not correspond to the Gamin-TXT format.

■ Input Type

Access Menu 331.



Off: You can perform APRS communications without the use of an external GPS receiver or Weather Station. Set your station position data manually through Menu 360 (MY Position) or use the internal GPS receiver.

GPS: You can perform APRS communications using an external GPS receiver. Verify your station position data by pressing the [POS] key.

Weather (Davis): You can perform APRS communications using a Davis Weather Station. Verify your station weather data by pressing the [F], [POS] key.

- Operation verification model (as of November 2011) Vantage PRO2™
- Please use the Data Logger bundled with "WeatherLink® for Vantage Pro2™, Windows, Serial Port" (Davis Part No.06510SER) or "WeatherLink® for APRS, with Streaming Data Logger" (Davis Part No.06540) with Vantage PRO2™.
- When using the "WeatherLink® for APRS, with Streaming Data Logger" (Davis Part No.06540) Data Logger, set the Baud Rate (Menu 330) to 9600bps for stable operation.

Weather (PeetBros.): You can perform APRS communications using a PeetBros Weather Station. Verify your station weather data by pressing the [F], [POS] key.

- Operation verification model (as of November 2011) ULTIMETER® 2100 (Packet mode)

■ Output Type

Access Menu 332.

```
COM Port 332
Baud Rate
Input
▶Output Off
```

Waypoint: Waypoint/ DGPS information is forwarded. The callsign and positioning data received from another station can be displayed as the waypoint data through the device connected to your GPS receiver or on the GPS receiver display.

Note: When Menu No. 331 is set to "Off" or Weather Station Unit is selected, the Way Point data is not output.

SETTING WAY POINT

■ Way Point Format

Access Menu 340.

```
Waypoint 340
▶Format
Length
Output NMEA
```

Select the type of Way point Format that is sent.

NMEA: The data which is output from the GPS terminal using the NMEA-0183 "\$GPWPL" format.

MAGELLAN: The data which is output from the GPS terminal using the "\$PMGNWPL" format.

KENWOOD: The data which is output from the GPS terminal using the "\$PKWDWPL" format.

■ Way Point Length

Access Menu 341.

```
Waypoint 341
Format
▶Length
Output 6-Char
```

Select the length of the Way Point Name. The length can be set as "6-Char", "7-Char", "8-Char", or "9-Char".

■ Way Point Output

Access Menu 342.

```
Waypoint 342
Format
Length
▶Output All
```

All: All Way point information is sent.

Local: If the position limit is ON, all the data within the position limit is sent. If the position limit is OFF, all Way point data is sent.

Filtered: Information that is permitted using the packet filter is output as Way point information.

PC PORT ON/OFF

■ Output

Access Menu 350.

```
PC Port 350
▶Output Off
```

This function outputs data from the PC (USB) port <Baud rate: 9600 bps> after receiving packet and TNC command data from the APRS data communications. Use this function to verify the received data from the transceiver.

PROGRAMMING POSITION DATA

■ Select Position channel

Access Menu 360.

```
MyPosition 360
▶*1 JJ00AA
Name :
N 00°00.00'
W 000°00.00'
```

This transceiver has 5 memory channels for storing position data. Program latitude and longitude data for up to 5 locations from which you will often transmit APRS packets. You can also name the 5 memory channels.

■ Name Entry

Access Menu 361.

```
MyPosition 361
*1 JJ00AA
▶Name : ▶Home
N 00°00.00'
W 000°00.00'
```

You can enter alphanumeric characters plus special ASCII characters (up to 8 digits).

■ Latitude Entry

Access Menu 362.

```
MyPosition 362
*1 JM03AP
Name Home
▶N 33°39.28'
W 000°00.00'
```

<Menu 3W0: "dd°mm.mm" >

```
MyPosition 362
*1 JM03AP
Name: Home
▶N 33°39'28.0"
W 000°00'00.0"
```

<Menu 3W0: "dd°mm'ss.s" >

The north/ south latitude is entered.

■ Longitude Entry

Access Menu 363.

```

MyPosition 363
*1          EM73SP
Name       Home
N          33°39.28'
W          084°27.08'
    
```

<Menu 3W0: "dd°mm.mm' ">

```

MyPosition 363
*1          EM73SP
Name:      Home
N          33°39.28.0"
W          084°27.08.0"
    
```

<Menu 3W0: "dd°mm'ss.s' ">

The east/ west longitude is entered.

SETTING BEACON INFORMATION

■ Speed Information

Access Menu 370.

```

BeaconInfo 370
▶Speed
Altitude
Pos. Ambiguity On
    
```

Select whether or not to transmit speed information when using APRS data communications.

■ Altitude Information

Access Menu 371.

```

BeaconInfo 371
Speed
▶Altitude
Pos. Ambiguity On
    
```

Select whether or not to transmit altitude information when using APRS data communications.

- When the beacon type is "NAVITRA", this information will not appear on the display.

■ Position Ambiguity

Access Menu 372.

```

BeaconInfo 372
Speed
Altitude
▶Pos. Ambiguity
1-Digit
    
```

There may be cases where you do not know or do not want to report your precise locations. For position data, you can select the number of digits not to be included in your packets. Select 1 to 4, or Off (default). The table shows how the digits are cleared.

OFF	1-Digit	2-Digit	3-Digit	4-Digit
33°50.43	33°50.4	33°50.	33°5X.	33° .
118°13.72	118°13.7	118°13.	118°1X.	118° .

- When the beacon type is "NAVITRA", this information will not appear on the display.

SELECTING A POSITION COMMENT

Access Menu 380.

```

Comment 380
▶Position Comment

Off Duty
    
```

The APRS data which you transmit always includes one of the 15 predetermined position comments. Select an appropriate comment depending on your situation.

The selectable comments are listed below:

"Off Duty", "Enroute", "In Service", "Returning", "Committed", "Special", "PRIORITY", "CUSTOM 0 ~ CUSTOM 6" or "EMERGENCY!"

- If you select "EMERGENCY!", a confirmation message appears. Press [▶OK] again.

```

Comment 380
▶Position Comment

Are you sure?
EMERGENCY!
    
```

ATTENTION:

When it is unnecessary, never select "EMERGENCY!". When an emergency signal is received using APRS, the Emergency Alarm on all stations will sound.

■ QSY Transmission Operation

- 1 Access Menu 3A0.

```
QSY(FREQ) 3A0
▶QSY in Status
Tone/Narrow
Shift/Offset Off
```

- 2 Set it to "On".
- 3 Access Menu 3A1.

```
QSY(FREQ) 3A1
QSY in Status
▶Tone/Narrow
Shift/Offset Off
```

- 4 Set it to "On" or "Off".
- 5 Access Menu 3A2.

```
QSY(FREQ) 3A2
QSY in Status
▶Tone/Narrow
Shift/Offset Off
```

- 6 Set it to "On" or "Off".

■ Operation when Receiving a QSY

When QSY (frequency) information is received, the station list appears with the verified frequency. Select [Tune], then press [▶OK].

```
1:W6DJY
▶Tune 446.000
Sort
```

- The QSY (frequency) is set to the non data band.

Note: When using 6.5 kHz or 12.5 kHz step values, the display does not indicate values for 100 Hz and lower.

SETTING PACKET FILTER

■ Position Limit

Access Menu 3B0.

```
Pkt. Filter 3B0
▶Position Limit
Filter Type
50 km
```

If APRS is popular in your area, you may receive too many APRS packets for a short period. If this disturbs your APRS activities, specify a distance from your location. You will not receive APRS packets from stations beyond this distance.

Select the range from 10 to 2500 in steps of 10, plus OFF (default). The unit is mile or kilometer depending on the selection in Menu 3V0 (Units 1).

■ Packet Filter Type

- 1 Access Menu 3B1.

```
Pkt. Filter 3B1
Position Limit
▶Filter Type
*Weather
```

- 2 Select the Filter type to "Weather", "Digipeater", "Mobile", "Object", "Navitra", "1-WAY", or "Others".
- 3 Press [▶OK].
 - When you press [MHz], the "*" icon appears on the left side of the Filter type.

The APRS position data is filtered.

- Check the type(s) you want to receive.
- If all types are checked, you will receive all types of data.

SELECTING YOUR STATION ICON

Access Menu 3C0.

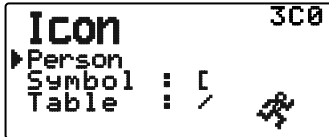

Select an icon which will be displayed on the monitors of other stations as your ID. You may select an icon depending on your current location.

It is important that the icon conveys the operational status of the station as well as the SSID. You can display and set the following icons for the TH-D72.

KENWOOD (\K)	Eyeball (/E)
Lighthouse (\L)	School (/K)
Satellite (\S)	PC user (/L)
SUNNY (\U)	Balloon (/O)
RADIO (\Y)	Police (/P)
ARRL (\a)	RV (/R)
RACES (\c)	SHUTTLE (/S)
Gale Flags (\g)	SSTV (/T)
HAM store (\h)	Sailboat (/Y)
WorkZone (\j)	Person (/I)
Speedpost (Value Singpost) (\m)	DF station (/A)
Triangle (\n)	WX (Weather station) (/L)
Small circle (\o)	Dish Antenna (/)
Tornado (\t)	Bicycle (/b)
Wreck (\x)	HOSPITAL (/h)
Sheriff (/!)	Jeep (/j)
Digipeater (/#)	Truck (/k)
GATEway (/&)	Mic-E Repeater (/m)
Aircraft (/')	Node (/n)
Red Cross (/+)	ROVER (/p)
Home (/ -)	QSO Repeater (/r)
X (/.)	Boat (/s)
Red Dot (/I)	Truck (18-wheeler) (/u)
Fire (/:)	Van (/v)
Portable (Tent) (/;)	Big Question Mark (/.)
Motorcycle (/ <)	IRLP/EchoLink (/0)
REILROAD ENGIN (/ =)	APRStt (/A)
Car (/ >)	
BBS (/B)	
Canoe (/C)	

APRS supports approximately 200 icons. It allows users to select each icon by specifying a combination of two ASCII codes, for example, ! and /. One is a symbol code, and the other is a table identification code (either / or \). If you select "Others", use the following procedures:

- 1 Access Menu 3C1.
- 2 Select a symbol code, then press [▶OK].



- 3 Select a a table identification code.

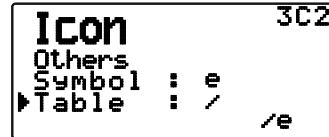

- **Overlay Icon Setting**

For example, to set the Digipeater icon to the letter "S", select "Others" under the icon type menu, select "#" under "Symbol", then select "S" under "Table".



Note:

- ◆ APRS icon codes (symbols/tables) are sometimes updated. Please refer to the following official APRS website (as of November 2011):
<http://www.aprs.org/symbols/symbolsX.txt>
<http://aprs.org/symbols/symbols-new.txt>
- ◆ Set an icon that represents your operational status. (For example, setting an Aircraft icon or Balloon icon to a fixed station will cause confusion when a station receives a beacon.)

SETTING TX BEACON

■ Packet Transmit Method

Access Menu 3D0.



Select the operation method for transmitting APRS packets. The table concludes how operations differ depending on the selection.

Manual:

Each press of [BCON] transmits your APRS packet.

PTT:

- 1 Press [BCON] to switch the function ON.
 - "BCON" appears and blinks.

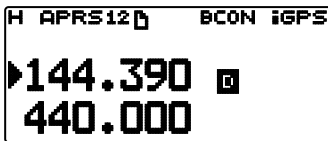

- 2 Press and hold [PTT], then speak into the microphone.
- 3 Release [PTT].
 - Releasing the switch transmits your APRS packet.
 - You cannot retransmit an APRS packet unless the time selected in < Initial Interval > passes. Wait until "BCON" starts blinking to indicate transmitting is ready.
- 4 To switch the function OFF, press [BCON] again.

Auto:

- 1 Press [BCON] to switch the function ON.
 - "BCON" appears.
 - Switching the function ON transmits your APRS packet once. After that, APRS packets are automatically transmitted at intervals of the period selected in < Initial Interval >.
- 2 To switch the function OFF, press [BCON] again.

SmartBeaconing:

- 1 Press [BCON] to switch the function ON.
 - "BCON" appears and blinks.
 - After manually transmitting your station position data 1 time, your position data will be automatically transmitted using the time interval set under "SmartBeaconing" (Menu Nos. 3F0 ~ 3G2).
- 2 To switch the function OFF, press [BCON] again.

Note: After setting "SmartBeaconing", the TX Interval Time, Decay Algorithm and Proportional Pathing features will no longer operate.

■ Quick Beacon

When setting "Method" to any value other than "Manual", you can manually transmit the Beacon.

Press [F], [BCON] transmits your APRS packet.

■ Initial Interval Time

Access Menu 3D1.

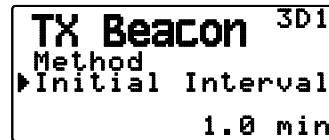

You can change the interval for automatically transmitting APRS packets. Select to 0.2, 0.5, 1, 2, 3, 5, 10, 20, 30 or 60 minutes. The default is 1 minute.

Note:

- ◆ With "Auto" in < Method > and Beacon ON, pressing [▶OK] to complete the setting causes the APRS packet to be immediately transmitted. After that, APRS packets are transmitted at intervals of the selected period.
 - ◆ While signals are present, an APRS packet is not transmitted after the interval. After signals drop, transmitting is executed.
-

SETTING ALGORITHM

■ Decay Algorithm

Access Menu 3E0.

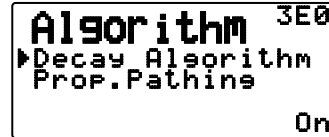

This function continuously extends the packet transmission interval in the case that there is no change of position information.

- When the position data does not change, the data is transmitted based on a Decay Algorithm (ex. Interval Time = 1 minute: 2 minutes, 4 minutes, 8 minutes, 16 minutes, 32 minutes, 32 minutes, 32 minutes, etc.)
- When My station position data changes, the data is transmitted using an interval time based on the set Initial Interval.
- When the set time elapses and transmission is performed but a busy signal is present, the transceiver does not transmit. When there is no longer a busy signal, the transceiver attempts to transmit.

Note:

- ◆ While transmitting by pressing the [PTT] switch, beacon transmission is reserved.
 - ◆ If My callsign is not set, the APRS packet will not be transmitted.
 - ◆ Independent of this interval, the transmission of the message is in 1 minute intervals.
-

■ Proportional Pathing

Access Menu 3E1.

```
Algorithm 3E1
Decay Algorithm
▶Prop.Pathing
On
```

This function automatically changes the transmit packet path with the elapsed time.

Operation example for when <Proportional Pathing> = ON

Transmission interval is 2 minutes. (When the <Decay Algorithm> = ON, the decay transmission interval takes precedence.)

The packet path changes with each transmission as shown below (when the packet path is set as WIDE1-1, WIDE2-1).

2 minutes : DIRECT

4 minutes : WIDE1-1 (1 Hop)

6 minutes : DIRECT

8 minutes : WIDE1-1, WIDE2-1 (2 Hops)

10 minutes : DIRECT

12 minutes : WIDE1-1 (1 Hop)

14 minutes : DIRECT

16 minutes : WIDE1-1, WIDE2-1 (2 Hops)

This is repeated.

When jointly using a Decay Algorithm, if the speed is 1 knots or slower, a Decay Algorithm pattern is used for transmitting, but if the speed is 3 knots or faster, it changes to Proportional Pathing.

SETTING SmartBeaconing™

Set to use "SmartBeaconing" (Menu 3D0) with APRS data transmission.

This function optimizes beacon transmission based on driving direction and speed. Use this function when you want to track your transmissions, especially for optimizing crossover beacon transmission intervals.

< SmartBeaconing™ from HamHUD Nichetronix >

■ Low speed / High speed

Access Menu 3F0.

```
SmartBcon1 3F0
▶Low/High Speed
Slow Rate
Fast Rate
26 - 30 km/h
```

Low speed setting (2 ~ 30 <mi/h, km/h or knots>).

When the speed is lower than this, beacons are transmitted at the time interval specified under "Slow Rate".

High speed setting (2 ~90 <mi/h, km/h or knots>).

When the speed is faster than this, beacons are transmitted at the time interval specified under "Fast Rate".

Note: To select the speed setting of the units, access Menu 3V0 (Units 1 - Speed, Distance).

■ Slow rate

Access Menu 3F1.

```
SmartBcon1 3F1
Low/High Speed
▶Slow Rate
Fast Rate
30 min
```

Low speed transmission interval time (1 ~ 100 minutes).

■ Fast rate

Access Menu 3F2.

```
SmartBcon1 3F2
Low/High Speed
Slow Rate
▶Fast Rate
30 sec
```

High speed transmission interval time (10 ~ 180 seconds).

■ Turn angle

Access Menu 3G0.

```
SmartBcon2 3G0
▶Turn Angle
Turn Slope
Turn Time
28 deg
```

Driving direction change, minimum value setting (5 ~ 90 degrees).

■ Turn slope

Access Menu 3G1.

```
SmartBcon2 3G1
Turn Angle
▶Turn Slope
Turn Time
245 (deg/speed)
```

Driving direction change, additional value setting (1 ~ 255 (10degrees/speed)).

■ Turn time

Access Menu 3G2.

```
SmartBcon2 3G2
Turn Angle
Turn Slope
▶Turn Time
30 sec
```

Minimum time delay between each beacon transmission by change of direction. (5 ~ 180 seconds).

Note: Adjust the Setting values to match the actual driving status.

SmartBeaconing Operation:

Speed	Transmission Interval	Corner Pegging
Above the <High Speed>	<Fast Rate>	Operates normally
Under <High Speed> Over <Low Speed> (Only when the set <High Speed> \geq <Low Speed>)	The interval is calculated using the following formula: (Transmission Interval = <Fast Rate> x <High Speed> \div Speed)	Operates normally
Below the <Low Speed>	<Slow Rate>	Will not operate

Transmission Interval Example:

(with <Low Speed> = 5, <High Speed> = 70, <Slow Rate> = 30 min, <Fast Rate> = 120 sec)

Speed	Interval
80	120 seconds (2 minutes)
70	120 seconds (2 minutes)
50	168 seconds (2 minutes 48 seconds)
30	280 seconds (4 minutes 40 seconds)
20	420 seconds (7 minutes)
10	840 seconds (14 minutes)
5	1680 seconds (28 minutes)
0	1800 seconds (30 minutes)

Corner Pegging Operation Example:

(with <Turn Angle> = 30° <Turn Slope> = 24)

Speed	<Turn Slope>	<Turn Slope> \div Speed (1)	<Turn Angle> (2)	Turn Threshold (3)=(1)+(2)
60	24 (x10)	4°	30°	34°
50	24 (x10)	6°	30°	36°
30	24 (x10)	8°	30°	38°
20	24 (x10)	12°	30°	42°
10	24 (x10)	24°	30°	54°
5	24 (x10)	48°	30°	78°

- When the value of "Turn Threshold" exceeds 120°, it is calculated as 120°.

PROGRAMMING A PACKET PATH

Access Menu 3H0.

```
PacketPath 3H0
Type : *New-N
WIDE1-1 : On
Total Hops : 2
[WIDE1-1,WIDE2-1]
```

Select the packet path type from "New-N", "Relay", "Region", or "Others".

When you press [MHz], the "*" icon appears on the left side of the packet path type, showing the current used information.

New-N:

This digipeat type has been used mainly in North America, but is now used worldwide.

- Set the <Type> to "New-N", then press [MHz].

```
PacketPath 3H0
Type : *New-N
WIDE1-1 : On
Total Hops : 2
[WIDE1-1,WIDE2-1]
```

- Set <WIDE 1-1> to "Off" or "On".

```
PacketPath 3H1
Type : *New-N
WIDE1-1 : On
Total Hops : 2
[WIDE1-1,WIDE2-1]
```

- Set <WIDE 1-1> to "On" to use the digipeater of the Fill-in type (RELAY type) with <New-N>.
- When set to "On", 1 packet path in addition to <WIDE 1-1> can be used, as per the <Total Hops> setting.

- Select the relay step number for the <Total Hops> setting.

```
PacketPath 3H2
Type : *New-N
WIDE1-1 : On
Total Hops : 2
[WIDE1-1,WIDE2-1]
```

- You can confirm the setting contents in [].

Relay:

This is one of the digipeat types used in Europe.

- 1 Set the <Type> to "Relay", then press [MHz].

```
PacketPath 3H0
▶Type : *Relay
RELAY : On
Total Hops : 2
[RELAY, TRACE2-1 ]
```

- 2 Set <RELAY> to "Off" or "On".

```
PacketPath 3H1
Type : *Relay
▶RELAY : On
Total Hops : 2
[RELAY, TRACE2-1 ]
```

- Set <RELAY> to "On" to use the digipeater of the Fill-in type (RELAY type) with the <Relay>.
- When set to "On", 1 packet path in addition to RELAY can be used, as per the <Total Hops> setting.

- 3 Select the relay step number for the <Total Hops> setting.

```
PacketPath 3H2
Type : *Relay
RELAY : On
▶Total Hops : 2
[RELAY, TRACE2-1 ]
```

- You can confirm the setting contents in [].

Region:

Use this method when the packet is being relayed within only a limited area.

Packet paths are specified using ABBR (abbreviations). (In America, for example, CA represents California, AZ represents Arizona, etc.)

- 1 Set the <Type> to "Region", then press [MHz].

```
PacketPath 3H0
▶Type : *Region
ABBR :
Total Hops : 2
[2-2 ]
```

- 2 Using the ABBR setting, enter an abbreviation of up to 5 characters.

```
PacketPath 3H1
Type : *Region
▶ABBR : ▶CA...
Total Hops : 2
[2-2 ]
```

- 3 Select the relay step number for the <Total Hops> setting.

```
PacketPath 3H2
Type : *Region
ABBR : CA
▶Total Hops : 2
[CA2-2 ]
```

- You can confirm the setting contents in [].

Others:

Use this method when the relay path is specified to an individual.

When a character string is not entered, the packet data is not relayed.

- 1 Set the <Type> to "Others", then press [MHz].

```
PacketPath 3H0
▶Type : *Others
PATH :
```

- 2 Enter a path.

```
PacketPath 3H1
Type : *Others
▶PATH : ▶W5DJY-1...
.....
```

- A Packet path is the digipeat route of the packet data sent from My station.

For example, if you want your packet to take the [W5DJY-1] > [W4DJY-1] route, enter [W5DJY-1, W4DJY-1], separating each digipeater callsign with a comma.

NETWORK

Access Menu 3I0 and 3I1.

```
Network 3I0
▶*APRS [APK003]
Altnet [ ]
```

```
Network 3I1
*APRS [APK003]
▶ Altnet [ ]
▶.....◀
```

Set APRS data communications UNPROTOCOL. UNPROTOCOL is the method in which packet data is transmitted without other stations or making a connection.

Select either "APRS(APK003)" or "Altnet".

APRS: (Use this setting for normal use: default setting)

When transmitting messages and meteorological data using the TH-D72, "APK003 is added to the packet, following your station callsign.

There are no restrictions on received packets.

Altnet: When it is necessary to add restrictions to received packets, you can set it for special use.

Select "Altnet" and press [MHz], then enter your desired character string.

When transmitting messages and meteorological data using the TH-D72, the character string you entered is added to the packet, following your station callsign.

VOICE ALERT

This function will notify another station as to whether or not they are within communications range by emitting beacon tones.

When a Mobile Station is mobile with the Voice Alert function turned ON, other stations also with Voice Alert turned ON will hear the beacon sound of the Mobile Station if they have matching tone (CTCSS) frequencies and are within range, thus informing the stations that communications is possible.

Press [F], [REV].

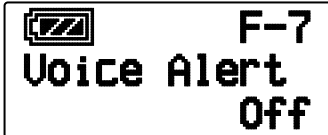

You can set Voice Alert to "Off", "On" or "RX Only". When using this function, you can also change the tone frequency, press [F], [8] [TONE]. (The default is 100Hz.)

Off: Voice Alert is disabled.

On: A tone frequency is added to the transmitted packet. "VA" appears above the displayed frequency.

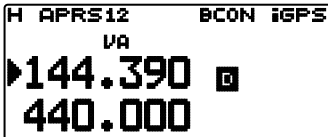

RX Only: A tone frequency is not added to the transmitted packet. "VAR" appears above the displayed frequency.



Note:

- ◆ When the built-in data band is set to cross band, the Voice Alert function does not operate.
- ◆ Voice alert takes precedence even when TONE, CTCSS and DCS are set.
- ◆ When Voice alert is ON, you cannot perform TONE or CTCSS frequency selection and DCS code selection.
- ◆ When the packet speed is 9600 bps, the TONE will disrupt the demodulation of the packet. Set the packet speed to 1200 bps when using Voice Alert.

WEATHER STATION DATA OUTPUT

Transmit

Access Menu 3J0.



This setting determines whether or not to transmit the meteorological data obtained from the Weather Station, with the APRS data communication.

Transmit Interval Time

Access Menu 3J1.



Set the interval at which the meteorological data is transmitted with the APRS data communication.

The interval can be set to 5, 10, 30, or 60 minutes.

- The following meteorological data is transmitted:
 - Rainfall
 - Air temperature
 - Wind direction
 - Wind velocity
 - Atmospheric pressure
 - Humidity
- This data is transmitted with the APRS standard format (latitude/longitude and time information).
- You can verify the meteorological data being output by viewing "My Weather". (Press [F], [POS])

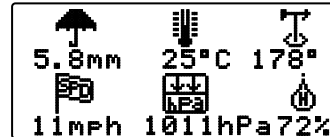

■ UITRACE

When using the TH-D72 as a digipeater, set whether or not UITRACE digipeat runs.

When the received UI Frame character string matches the entered alias (for example, WIDE), the number of hops (for example, 2-2) is processed and decreased by 1 (for example, WIDE2-2 becomes WIDE2-1), and your station callsign is added to the UI Frame.

- 1 Access Menu 300.

```
UITrace      300
▶UITrace
Alias
Off
```

- 2 Set <Ultrace> to "On" or "Off".

- 3 Access Menu 301.

- You enter Alias Setting mode.

```
UITrace      301
UITrace
▶Alias
WIDE
```

- 4 Enter the UITRACE alias.

- When running UITRACE digipeat, set the character string of the alias that is used.

STORING USER PHRASES

Access Menu 3P0.

```
Phrases      3P0
▶User Phrase1

```

This function (clipboard image) allows you to paste phrases into the APRS message compilation mode. You can create up to 8 phrases each of which can consist of up to 32 characters.

- The user phrase function can only be used in the message compilation mode.
- Before a message is copied, the number of letters cannot be guaranteed. Only the number of letters available will be copied, the remainder will be truncated.
- To copy a message, enter message compilation mode, press [F] to enter function mode, then press [1] (Paste 1), [2] (Paste 2), [3] (Paste 3), [4] (Paste 4), [5] (Paste 5), [6] (Paste 6), [7] (Paste 7), or [8] (Paste 8) key for 1 second to copy the message that has been set up for each key.
- If the user messages are not set up, they cannot be used.

STORING AUTO MESSAGE REPLY

While you are driving, for example, you cannot immediately answer to received messages. On this transceiver, you can program the message to be automatically returned when a message is received.

■ Reply

Access Menu 3Q0.

```
Auto-Reply  3Q0
▶Reply
Reply To
Delay Time
On
```

Set <Reply> to "On" or "Off".

- "AA.", meaning "Auto Answer message", is automatically added to the beginning of all auto-reply messages. This has been added, based on the recommendations of "APRS SPEC Addendum 1.1". Refer to <http://aprs.org/aprs11.html> for details.

■ Reply To Callsign

Access Menu 3Q1.

```
Auto-Reply  3Q1
Reply
▶Reply To
Delay Time
JA1YKX
```

When there is a message you would like to reply to for the specific callsign, preset that callsign for automatic responses.

- A reply will be sent to all matching stations when using the wildcard mark (*).
For example, if you enter JA1*, a response is sent to all callsigns beginning with JA1.

■ Reply Delay Time

Access Menu 3Q2.

```
Auto-Reply  3Q2
Reply
Reply To
▶Delay Time
10 sec
```

After a message has been received, if you operate the transceiver during the delay time, before the message is sent, the auto-reply message is canceled. You can set the wait time as 0, 10, or 30 seconds. The default setting is 10 seconds.

- When a message is received before the delay time has completed counting down, the timer will reset and begin counting down again.
- When multiple messages are received from the same caller before the delay time has completed counting down, only one message will be sent through auto-reply message.
- When the delay time is set to 0 seconds, auto-reply message will send a response immediately following an acknowledged received message.

■ Reply Text

Access Menu 3R0.

```

Reply Msg 3R0
▶Text :▶

```

- The display for entering a message appears; the first digit blinks.
- You can enter alphanumeric characters plus special ASCII characters.

PROGRAMMING A MESSAGE GROUP CODE

Access Menu 3S0 .

```

Group Fitr 3S0
▶Message
Bulletin (BLN)
ALL, QST, CQ, KWD

```

Use a message group code to exchange messages only among your group members. With one or more message group codes programmed, you will receive messages that include the same group code(s), besides messages addressed to you. If you program one or more bulletin group codes, you will not receive bulletins addressed to other specific groups. You can program any desired code using alphanumeric characters; up to 9 characters for messages, and up to 4 characters for bulletins. You can also program up to 6 codes at the same time; each code must be separated by a comma (.). If you program 3 message group codes, for example, you will receive all messages that include one of the 3 codes. If you program 3 bulletin group codes, you will reject bulletins addressed to specific groups which do not use any of the 3 codes.

```

Group Fitr 3S0
▶Message
Bulletin (BLN)

```

- You can enter 0 to 9, A to Z, , (comma), and -. For messages, "X" is also selectable.
- The keypad on the microphone also is available to enter alphanumeric characters.
- In order to include a message group code in your outgoing packet, enter a group code in place of a callsign. To include a bulletin group code, enter it following BLN#; for example, "BLN#ABC" where ABC is a group code. Use up to 9 characters for a message group code or up to 4 characters for a bulletin group code.

Note: Unlike a message, a bulletin including a group code will be received by stations who do not program any bulletin group code.

SETTING SOUND

■ RX Beep Type

Access Menu 3T0.

```

Sound 3T0
▶RX Beep
TX Beep
Special Call All

```

This transceiver beeps each time it receives any type of APRS packets.

Selection	Operation
Off	The APRS beep tone does not sound.
Message Only	Beep sounds only when a message is received at your station address.
Mine	Beep sounds when a message is received at your station address and your transmitted data is received by a digipeater.
All New	Beep sounds when a message is received at your station address and new packet data is received.
All	Beep sounds when a message is received at your station address and duplicate data or invalid data is received.

■ TX Beep

Access Menu 3T1.

```

Sound 3T1
RX Beep
▶TX Beep
Special Call Off

```

When a beacon containing your station position information (My position information) is transmitted in a manner other than manually, you can select whether or not it emits a beep sound.

Off: A beep does not sound.

On: A beep sounds when a beacon is transmitted using the PTT switch or when it is automatically transmitted. When auto-reply message sends a response, a beep (morse code A) will sound.

Note: Depending on the congestion level of the transmission channel, the transmission beep sound may be delayed when using the internal TNC DCD sense function.

■ Special Call Sound

Access Menu 3T2.

```

Sound 3T2
RX Beep
TX Beep
▶Special Call
▶JAIYKX

```

This function emits a special call sound when data is received at My station address. Set the callsign of the stations from which you want to receive special call notifications.

SETTING DISPLAY

■ Display Area

Access Menu 3U0.

```
Display 3U0
▶Display Area
  Interrupt Time
  Cursor Control
  Entire Disp
```

Selects the Display area.

Entire Always: The received new data, duplicate data, and My station data information appears on the full display, other data information appears only at the top of the display.

```
▶W6DJY-9
  Enroute to
  🚗 Hamfest.
```

Entire Disp: The received new data information appears on the full display, other data information appears only at the top of the display.

One Line: The received new data information appears only at the top of the display.

```
dp W6DJY-9
▶144.390 📻
  440.000
```

Note: When an emergency message or a message designated for your station is received, the received data information appears on the full display, even if the display method is set to "One Line".

■ Interrupt Time

Set the duration to display an indication for when new data is received. If you select "Infinite", the indication cannot be canceled.

Access Menu 3U1.

```
Display 3U1
  Display Area
  ▶Interrupt Time
  Cursor Control
  10 sec
```

The Interrupt time can be set to 3, 5, 10 seconds or "Infinite".

■ Cursor Control

Select a cursor control setting for when receiving.

Access Menu 3U2.

```
Display 3U2
  Display Area
  Interrupt Time
  ▶Cursor Control
  Followed
```

Followed: On the list screen, the cursor (▶) follows the callsign when receiving APRS data.

```
-STATION LIST-
▶ 1:W6DJY-9 15:08F
  2:JA1VKX-7 15:01F
  3:DF0TK-14 14:55
  4:W5DJY 14:52
  5:9U1KW-13 14:49
```

```
-STATION LIST-
▶ 2:W6DJY-9 15:08F
  3:JA1VKX-7 15:01F
  4:DF0TK-14 14:55
  5:W5DJY 14:52
  6:9U1KW-13 14:49
```

Fixed: On the list screen, the cursor (▶) sits at the list number when receiving APRS data.

```
-STATION LIST-
▶ 1:W6DJY-9 15:08F
  2:JA1VKX-7 15:01F
  3:DF0TK-14 14:55
  4:W5DJY 14:52
  5:9U1KW-13 14:49
```

```
-STATION LIST-
▶ 1:W3DJY-7 15:52F
  2:W6DJY-9 15:08F
  3:JA1VKX-7 15:01F
  4:DF0TK-14 14:55
  5:W5DJY 14:52
```

SELECTING A DISPLAY UNIT

■ Speed, Distance

Access Menu 3V0.

```
Units 1 3V0
▶Speed, Distance
Altitude, Rain
Temperature
mi/h, mile
```

Select to “mi/h, mile”, “km/h, km”, or “knots, nm”.

■ Altitude, Rainfall

Access Menu 3V1.

```
Units 1 3V1
Speed, Distance
▶Altitude, Rain
Temperature
feet, inch
```

Select to “feet, inch” or “m, mm”.

■ Temperature

Access Menu 3V2.

```
Units 1 3V2
Speed, Distance
Altitude, Rain
▶Temperature °F
```

Select to “°F” or “°C”.

■ Latitude longitude

Access Menu 3W0.

```
Units 2 3W0
▶Position
Grid format
dd°mm.mm'
```

Select to “dd°mm.mm’”, or “dd°mm’ss.s”.

■ Grid Format

Access Menu 3W1.

```
Units 2 3W1
Position
▶Grid format
Maidenhead Grid
```

Select to “Maidenhead Grid”, “SAR Grid (CONV)”, or “SAR Grid (CELL)”.

SELECTING A NAVITRA GROUP

■ Group Mode

Access Menu 3X0.

```
NAUITRA GP 3X0
▶Group mode
Group code
Off
```

Select to Group mode “On” or “Off”.

■ Enter Group Code

Access Menu 3X1.

```
NAUITRA GP 3X1
Group mode
▶Group code
|_|_|_|_|
```

You can enter 0 to 9, A to Z.

Note: The Navitra system was introduced by Kenwood in the 1990's, for use within Japan.

STORING NAVITRA MESSAGE

- 1 Access Menu 3Y0.
- 2 Select the message number.

```
NAUITRA MS 3Y0
▶*Message 1
```

- 3 Press [▶OK].
- 4 Enter the phrases.

```
NAUITRA MS 3Y0
▶ Message 1
|_|_|_|_|
|_|_|_|_|
```

You can create up to 5 phrases each of which can consist of up to 20 characters.

DX PACKETCLUSTERS MONITOR

DX PacketClusters are networks which consist of nodes and stations who are interested in DXing and contesting. If one station finds a DX station on the air, they will send a notice to their node. This node then passes the information to its local stations through another node. The DX PacketCluster monitor function receives the packet data of the DX cluster and displays the contents. This transceiver can retain the latest information on up to 10 DX stations, but the memory will be cleared when the transceiver power supply is turned Off. If you have a TS-590S, TS-480HX/SAT, TS-2000/X, TS-570S/D, or TS-870S HF transceiver, you can connect the TH-D72 to the HF transceiver to use the DX PacketCluster Tune function. You can use this function to monitor the latest DX information in your area, but it cannot be used to send DX information to a node.

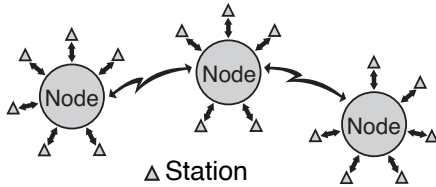

1 Access Menu 310 (Int. TNC - Data Band) to select band A or B.

- If the common transfer rate in your local PacketCluster network is 9600 bps, access Menu 311 (Int. TNC - Data Speed) and select "9600 bps".

2 Tune to the frequency of the target PacketCluster node.

3 Press **[TNC]** to enter APRS mode.

- "APRS" should appear.

4 Press **[F]**, **[LIST]**.

- Each time new DX cluster data is received, a callsign, frequency, and time are displayed.
- When a duplicate DX cluster data is received, "DX" and a callsign are displayed.

```

DX:9U1KW
21295.0
0906Z
  
```

5 Press **[▶OK]**.

- DX station detailed display mode

```

DX:9U1KW
Strong sig
S!
  
```

- Press **[ESC ◀]**: Restores the frequency display.
- Press **[MENU]**: Outputs the PCT data.

Note: The Packet Cluster data (PCT) is output only when Menu No.311-COM Port-input is set to "Off".

■ Connecting TH-D72 with the HF Transceiver

In order to connect TH-D72 to the HF transceiver, you need to prepare three cables by yourself.

The COM terminal on this transceiver accepts a 2.5 mm (1/10") 3-conductor plug. If necessary, use the cable (service part: E30-3400-XX) to modify the cable end of RS-232-C connector.

HF transceiver

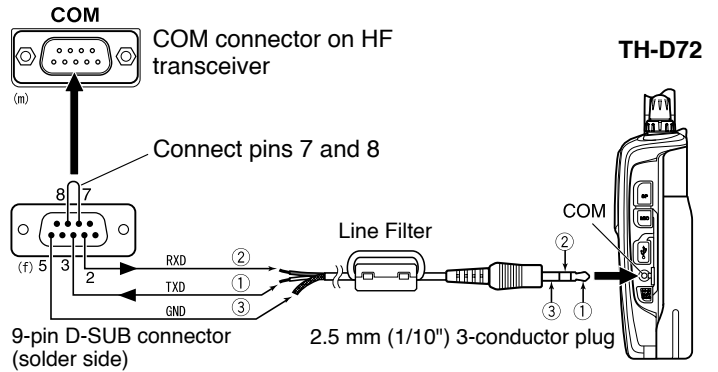

- Attach the line filter to the cable.

TRANSCEIVER RESET

There are 3 types of transceiver reset available:

VFO Reset

Use to initialize the VFO and accompanying settings.

Partial Reset

Use to initialize all settings other than the Memory channels, the DTMF memory, and the PM channels.

FULL Reset

Use to initialize all transceiver settings that you have customized. (Date and time are not reset.)

There are 2 ways to perform a reset on the transceiver: by key operation and by accessing Menu mode.

KEY OPERATION

- 1 Turn the transceiver power OFF.
- 2 Press **[F] + Power ON**.
- 3 Press **[▲]/[▼]** or rotate the **Tuning** control and select your desired reset type: "VFO Reset", "Partial Reset", or "Full Reset".



▶Reset
UFO Reset

- 4 Press **[▶OK]** to set the reset type.
 - A confirmation message appears on the display.



UFO Reset
Sure?▶[OK]

- Press **[ESC ◀]** to cancel the reset.
- 5 Press **[▶OK]** again to perform the reset.

MENU MODE

- 1 Enter Menu mode and access Menu 199.



Auxiliary 199
▶Reset
UFO Reset

- 2 Press **[▲]/[▼]** or rotate the **Tuning** control and select your desired reset type: "VFO Reset", "Partial Reset", or "Full Reset".
- 3 Press **[▶OK]** to set the reset type.
 - A confirmation message appears on the display.

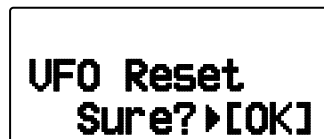

UFO Reset
Sure?▶[OK]

- Press **[ESC ◀]** to cancel the reset.
- 4 Press **[▶OK]** again to perform the reset.

SKY COMMAND SYSTEM II

The SKY COMMAND SYSTEM II allows remote control of a TS-2000, TS-2000X, TS-B2000, TS-480HX, TS-480SAT, TS-590S, TS-570D, TS-570S, or TS-870S HF transceiver.

You will use one transceiver as a control station called "Commander". The transceiver connected with the HF transceiver is called "Transporter". It will function as an interface between the Commander and the HF transceiver. This system allows you, for example, to watch for and hunt DX while washing your car, or to operate the HF transceiver while relaxing in your car, living room, or patio, instead of in your shack.

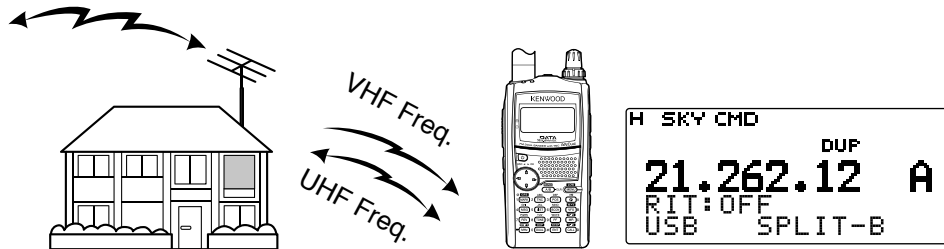

The Commander and Transporter transfer audio and commands as below:

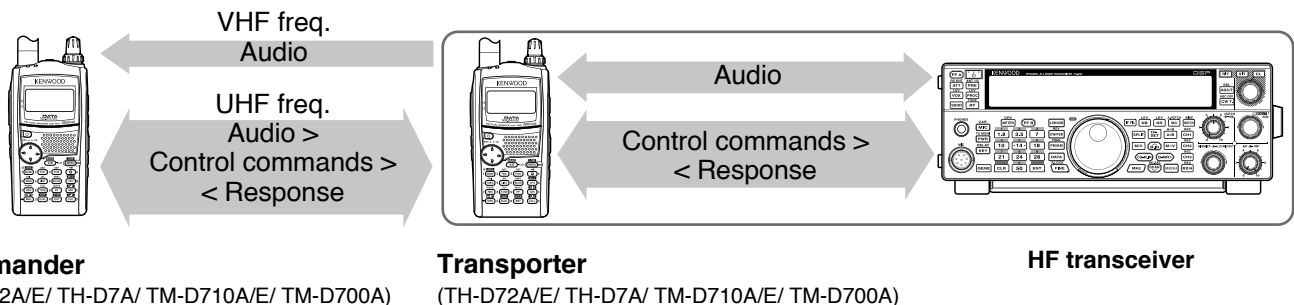

CONNECTING THE TRANSPORTER WITH THE HF TRANSCEIVER

In order to connect TH-D72 to the HF transceiver, you need to prepare three cables by yourself. The COM terminal on this transceiver accepts a 2.5 mm (1/10") 3-conductor plug. If necessary, use the cable (service part: E30-3400-XX) to modify the cable end of RS-232-C connector.

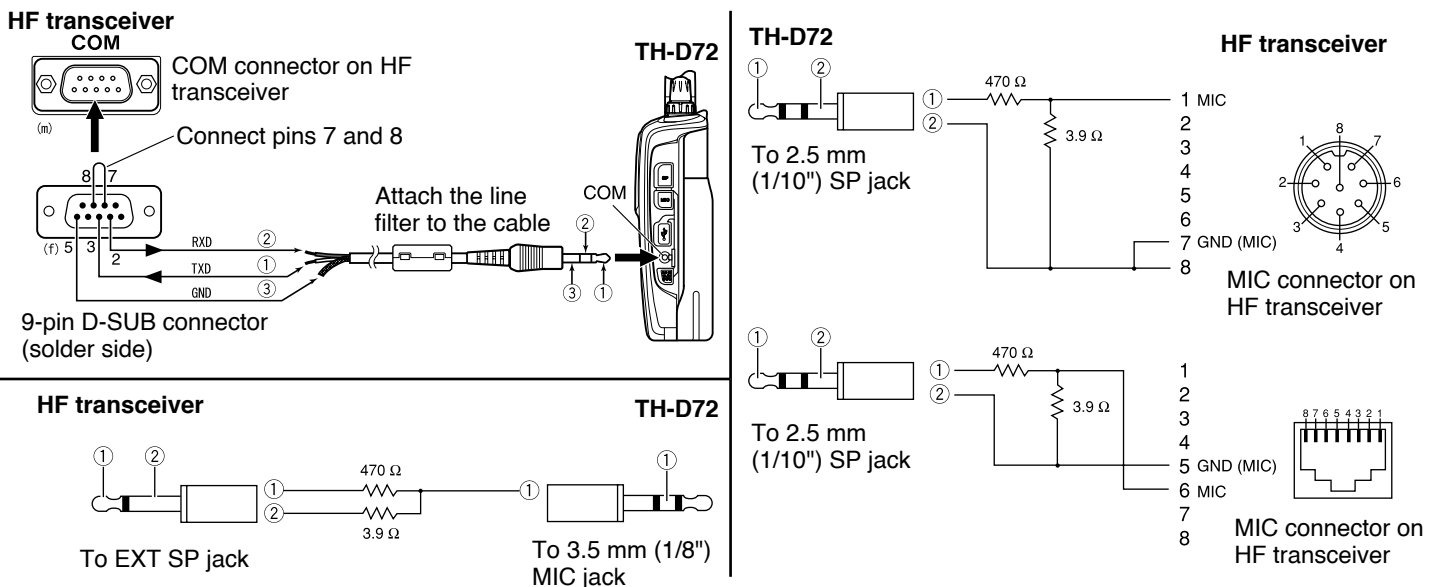

- Note:**
- ◆ Operation of Sky Command System II may not be permitted in certain countries. Check your local laws before operating.
 - ◆ Switch OFF both the Transporter and HF transceiver before making the connection.
 - ◆ The Transporter automatically transmits its callsign in Morse at regular intervals because of legal requirements; therefore, transmit side tone must be output from the HF transceiver.
 - ◆ When the Transporter is too close to the HF transceiver, unwanted feedback may cause malfunction.
 - ◆ Do not share a regulated power supply between the Transporter and the HF transceiver. Unwanted feedback may cause malfunction.

PREPARATION FLOW

The following steps should guide you to a good start of Sky Command operation. First connect the Transporter to the HF transceiver.

- 1 <On the Commander and Transporter> Select the same VHF and UHF frequencies.

When using the TH-D72 to communicate with the Commander and Transporter, set the TH-D72 as described below.

<Commander>

Band A: VHF frequency Band B: UHF frequency

Full Duplex: ON Tone: ON (Band B)

<Transporter>

Band A: UHF frequency Band B: VHF frequency

Full Duplex: ON CTCSS: ON (Band A)

Note: Configure the squelch to an appropriate level for both the VHF and UHF band on the Commander and Transporter. If the squelch is not set to an appropriate level, the transceivers may enter a BUSY state due to noise signals and be unable to transmit.

- 2 <On the Commander> Access Menu 500 to program a callsign (9 digits max.) for the Commander.

- You may enter your exact callsign; ex. W6DJY.

```
SkyCommand500
▶CMD Callsign
▶W6DJY-1-1-1-1-1-1-1-1-1
```

- 3 <On the Commander> Access Menu 501 to program a callsign (9 digits max.) for the Transporter.

- This callsign must be different from the one for the Commander. So you may add SSID characters; ex. W6DJY-1.

```
SkyCommand501
▶TRP Callsign
▶W6DJY-1-1-1-1-1-1-1-1-1
```

- 4 <On the Transporter> Access Menu 500 to program the same callsign as you entered in step 2.
- 5 <On the Transporter> Access Menu 501 to program the same callsign as you entered in step 3. The same callsign as you entered in step 2.
- 6 <On the Commander and Transporter> Access Menu 502 and select the tone frequency.
 - Select the same tone frequency on both transceivers.

```
SkyCommand502
▶Tone Freq.
88.5Hz
```

- 7 <On the Commander> Access Menu 503 and select "Commander".

```
SkyCommand503
▶Sky Command
Commander
```

- "Push [0] key to Start Commander!!" appears.

```
Push [0] key
to Start
Commander !!
```

- 8 <On the Transporter> Access Menu 503 and select "Transporter".

```
SkyCommand503
▶Sky Command
Transporter
```

Now the Commander and Transporter are in Sky Command mode. For operations in this mode, see "CONTROL OPERATION". First switch ON the HF transceiver and press [SYNC] on the Commander. To exit the Sky Command mode, access Menu 503 and select "Off".

Note:

- ◆ Unless you program callsigns, you cannot select "Commander" or "Transporter" using Menu 503.
- ◆ On the HF transceiver, select 9600 bps and 1 stop bit (default) using the Menu Set-up function.
- ◆ Adjust the audio level on both the Transporter and HF transceiver while listening to audio output from the Commander. An appropriate position of the AF control on the HF transceiver might be in the range, 8:30 to 9:00.
- ◆ To distinguish your various stations or nodes, you can have up to 15 Secondary Station IDentifiers (SSIDs); ex. W6DJY-1 to W6DJY-15. You always have to put a dash between your callsign and SSID number.
- ◆ Your station's transmit signal can be received when the receive frequency is 3 times the transmit frequency.
Example: Transmit frequency is 146.600 MHz and receive frequency is 438.000 MHz.

ATTENTION: Use only after verifying that there is no reception disruption during communications.

PROGRAMMING CALLSIGNS

The built-in TNCs of the Commander and Transporter communicate each other when you send a control command from the Commander. So you must program different callsigns (9 digits max.) on these transceivers as the IDs of the TNCs.

Use the following Menu Nos. to program callsigns:

On Commander		
500	COM Callsign	Callsign for Commander
501	TRP Callsign	Callsign for Transporter
On Transporter		
500	COM Callsign	Callsign for Commander
501	TRP Callsign	Callsign for Transporter

- Access Menu 500 or 501, then **[▶] (OK)**.
 - The callsign entry field appears; the first digit blinks.



- Press **[▲]/[▼]** or rotate the **Tuning control** to select a character.
 - You can enter 0 to 9, A to Z, and –.
- Press **[▶OK]**.
 - The cursor moves to the next digit.
- Repeat steps 2 and 3 to enter up to 9 digits.
 - [ESC ◀]**: Cancels entry of a callsign.
 - [A/B]**: Deletes the digit at which the cursor is blinking.
- Press **[▶OK]** to complete the setting.
- Press **[MENU]** to exit Menu mode.
 - The keypad also is available to enter alphanumeric characters in step 2.

PROGRAMMING A TONE FREQUENCY

On receiving a tone from the Commander, the Transporter causes the HF transceiver to enter Transmit mode. On both the Commander and Transporter, access Menu 502 and select the desired, same tone frequency.



CONTROL OPERATION

When in the Sky Command mode, the keys of the Commander will function as below. First switch ON the HF transceiver and press **[0] (SYNC)** on the Commander.

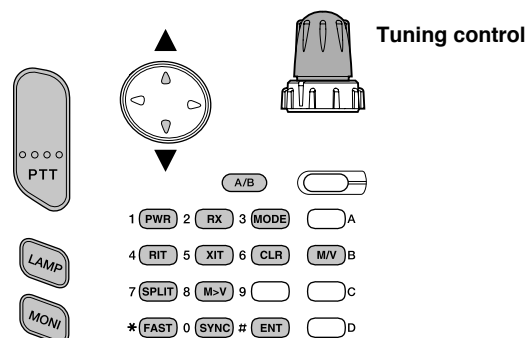

Each time you press the desired key, the Commander will automatically enter transmit mode and send the corresponding control command to the Transporter.

Key	Function
Tuning control	Frequency or memory channel number change
[A/B]	In VFO mode: VFO A/ VFO B switch In Memory Recall mode: no change
[1] (PWR)	Power ON/ OFF
[2] (RX)	HF frequency receive ON/ OFF
[3] (MODE)	Modulation mode switch
[4] (RIT)	RIT ON/ OFF
[5] (XIT)	XIT ON/ OFF
[6] (CLR)	RIT offset or XIT offset clear
[7] (SPLIT)	Split-frequency ON/ OFF
[8] (M>V)	Transfer from Memory to VFO
[0] (SYNC)	Current settings retrieve (from HF transceiver)
[MONI]	To monitor the UHF band on the Commander
[B] (M/V)	VFO/ Memory Recall mode switch
[▲]	XIT/ RIT offset frequency increase
[▼]	XIT/ RIT offset frequency decrease
[*] ¹ (FAST)	In LSB, USB, or CW mode: 10 Hz/ 1 kHz switch In FM or AM mode: 1 kHz/ 10 kHz switch
[#] ² (ENTER)	In VFO mode: frequency entry ON In Memory Recall mode: channel number entry ON
[PTT]	To transmit audio on an HF frequency

¹ "FS" appears when you select 1 kHz step (LSB/ USB/ CW) or 10 kHz step (FM/ AM).

² After pressing **[#]**, press **[0]** to **[9]** to enter a frequency or memory channel number.

WEATHER ALERT (TH-D72A ONLY)

The Weather Alert is available only in the USA and Canada. When activated, this function will check for a received NOAA 1050 Hz tone. When the tone is received, the weather alert tone will sound.

WEATHER ALERT ON/ OFF

- 1 Enter Menu mode and access Menu 13B.



- 2 Set the Weather Alert to "On" or "Off".
 - When activated, the "WX" icon appears on the display.
 - When a signal is being received, the "WX" icon blinks.

■ Weather Channel

Whether or not the Weather Alert is activated, you can still access the weather channels. The Weather Alert simply notifies you of activity on the weather channels.

- 1 Press the key programmed with the [WX] function.
- 2 Press [▲]/[▼] or rotate the **Tuning** control to select your desired channel.

Channel No.	Frequency (MHz)	Memory Name	Location
A1	162.550	WX 1	NOAA/ Canada
A2	162.400	WX 2	NOAA/ Canada
A3	162.475	WX 3	NOAA/ Canada
A4	162.425	WX 4	NOAA
A5	162.450	WX 5	NOAA
A6	162.500	WX 6	NOAA
A7	162.525	WX 7	NOAA
A8	161.650	WX 8	Canada
A9	161.775	WX 9	Canada
A10	163.275	WX 10	—

WEATHER ALERT SCAN

The memory channel only for the weather alert is scanned.

- 1 Enter Menu mode and access Menu 13C.

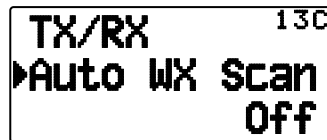

- 2 Set the Weather Alert Scan to "Off" or "15/ 30/ 60 (min)".

When the weather channel scanning time is set:

Auto scanning starts after the set time.

When the weather channel scanning is set to Off:

Press and hold the key programmed with the [WX] function to start the weather channel scan.

- Scanning stops when the channel with the highest signal level is received.
- Memory scanning stops when performing any operation other than [LAMP], [MONI], [key lock] ([F](1s)), [▲]/[▼], and Tuning control.

WIRELESS OPERATION (TH-D72A ONLY)

If you also have a **Kenwood** multi-band mobile transceiver, you can control one of its bands by sending DTMF tones from this handy transceiver. You will find this function useful when you want to control your mobile transceiver from a location outside your vehicle.

Note:

- ◆ You can remotely control only mobile transceivers that have both the secret number and Remote Control functions.
- ◆ FCC rules permit you to send control codes only on the 440 MHz band.

PREPARATION

Let us assume the VHF band of the mobile transceiver will be controlled.

On the handy transceiver:

1 Press [PTT] + [VFO] + Power ON.

- The current secret access code number appears. The default is 000.



2 To change the secret number, press the numeric keys (0 to 9) to enter a 3-digit number.

- You can also press [▲]/[▼] to select each digit. Press [▶OK] (or [ESC ◀]) to move the cursor to the next (or previous) digit.

3 Press [▶OK] to complete the setting.

4 Select the UHF band.

5 Select the transmit frequency.

6 Turn the transceiver power OFF.

7 Press [PTT] + [MR] + Power ON.

- The transceiver enters Remote Control mode. "Mobile Ctrl" appears.



- To exit Remote Control mode, repeat steps 6 and 7.

On the mobile transceiver:

8 Set the ID code to the same secret number you set on the handy transceiver.

- For the method, refer to the instruction manual for the mobile transceiver.

9 Select the receive frequency on the UHF band.

- Match this frequency with the transmit frequency of the handy transceiver.

10 Enter the transceiver's Remote Control mode.

- For the method, refer to the instruction manual for the mobile transceiver. If it is not described, consult your authorized **Kenwood** dealer, customer service, or service center.

CONTROL OPERATION

When in Remote Control mode, the keys of the handy transceiver will function as described below. Each time you press a key, the handy transceiver will automatically transmit the corresponding command to the mobile transceiver.

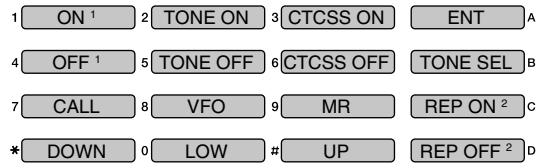

¹ TM-V7/ TM-D700: Revers ON/ OFF

TM-D710/ TS-2000: DCS ON/ OFF

Other than TM-V7/ TM-D700/ TM-D710/ TS-2000:
Tone Alert ON/ OFF.

² Switches Cross-band Repeater ON/ OFF if the mobile transceiver has this function.

To change the transmit/ receive frequency:

([VFO] → [ENT] → [0] ~ [9] (enter the necessary digits) → [ENT]) or ([VFO] → [▲]/[▼])

To recall a memory channel:

([MR] → [ENT] → [0] ~ [9] (enter the necessary digits) → [ENT]) or ([MR] → [▲]/[▼])

To change the tone (or CTCSS) frequency:

([TONE SEL] → [0] ~ [9] (enter 2 digits; ex. [0], [5]) → [TONE SEL])

- Use Nos. 01 to 42, as shown in the CTCSS table.
- Your mobile transceiver may require you to first activate the Tone or CTCSS function. It may also allow you to program a separate tone and CTCSS frequency. Check the instruction manual for the mobile transceiver.