

# KENWOOD

GPS NAVIGATION SYSTEM

## **DNX SERIES**

**DNX5260BT**

---

MONITOR WITH DVD RECEIVER

## **DDX SERIES**

**DDX5026 DDX5056**

---

## **INSTALLATION MANUAL**

Kenwood Corporation

## Accessories

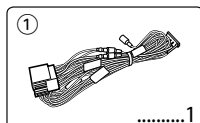

\*Accessory of DNX5260BT.  
†This accessory is used when connecting an external device to AV-IN jack on the front panel of this unit. For how to use this accessory, refer to the instruction manual of this unit.

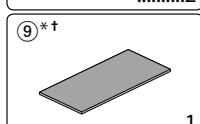
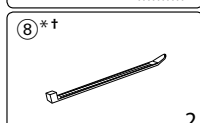
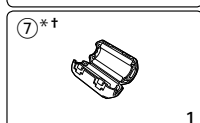
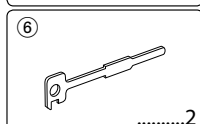
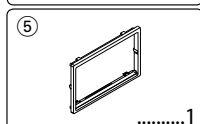
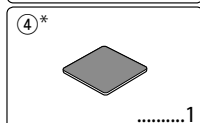
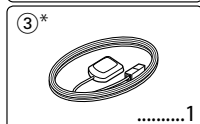
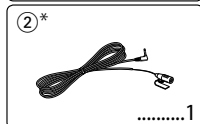

## Installation Procedure

1. To prevent short circuits, remove the key from the ignition and disconnect the ⊖ terminal of the battery.
2. Make the proper input and output wire connections for each unit.
3. Connect the wire on the wiring harness.
4. Take Connector B on the wiring harness and connect it to the speaker connector in your vehicle.
5. Take Connector A on the wiring harness and connect it to the external power connector on your vehicle.
6. Connect the wiring harness connector to the unit.
7. Install the unit in your car.
8. Reconnect the ⊖ terminal of the battery.
9. Press the reset button.

### ▲WARNING

- If you connect the ignition wire (red) and the battery wire (yellow) to the car chassis (ground), you may cause a short circuit, that in turn may start a fire. Always connect those wires to the power source running through the fuse box.

### Acquiring GPS Signals

The first time you turn on DNX5260BT, you must wait while the system acquires satellite signals for the first time. This process could take up to several minutes. Make sure your vehicle is outdoors in an open area away from tall buildings and trees for fastest acquisition. After the system acquires satellites for the first time, it will acquire satellites quickly each time thereafter.

### After the Installation

After the installation, perform the Initial Setup by referring to the instruction manual.



- Mounting and wiring this product requires skills and experience. For safety's sake, leave the mounting and wiring work to professionals.
- Make sure to ground the unit to a negative 12V DC power supply.
- Do not install the unit in a spot exposed to direct sunlight or excessive heat or humidity. Also avoid places with too much dust or the possibility of water splashing.
- Do not use your own screws. Use only the screws provided. If you use the wrong screws, you could damage the unit.
- If the power is not turned ON ("PROTECT" is displayed), the speaker wire may have a short-circuit or touched the chassis of the vehicle and the protection function may have been activated. Therefore, the speaker wire should be checked.
- Make sure that all wire connections are securely made by inserting jacks until they lock completely.
- If your vehicle's ignition does not have an ACC position, or if the ignition wire is connected to a power source with constant voltage such as a battery wire, the power will not be linked with the ignition (i.e., it will not turn on and off along with the ignition). If you want to link the unit's power with the ignition, connect the ignition wire to a power source that can be turned on and off with the ignition key.
- Use a commercially available conversion connector if the connector does not fit in the vehicle connector.
- Insulate unconnected wires with vinyl tape or other similar material. To prevent a short circuit, do not remove the caps on the ends of the unconnected wires or the terminals.
- If the console has a lid, make sure to install the unit so that the faceplate will not hit the lid when closing and opening.
- If the fuse blows, first make sure the wires aren't touching to cause a short circuit, then replace the old fuse with one with the same rating.
- Connect the speaker wires correctly to the terminals to which they correspond. The unit may be damaged or fail to work if you share the  $\ominus$  wires or ground them to any metal part in the car.
- After the unit is installed, check whether the brake lamps, blinkers, wipers, etc. on the car are working properly.
- Mount the unit so that the mounting angle is 30° or less.
- Do not press hard on the panel surface when installing the unit to the vehicle. Otherwise scars, damage, or failure may result.

- This unit has the cooling fan to decrease the internal temperature. Do not mount the unit in a place where the cooling fan of the unit are blocked. Blocking these openings will inhibit the cooling of the internal temperature and result in malfunction.

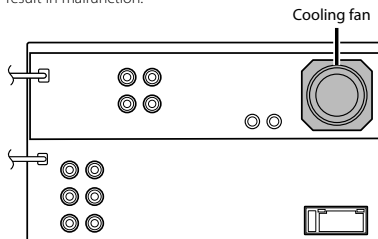

- Reception may drop if there are metal objects near the Bluetooth antenna. (DNX5260BT only)

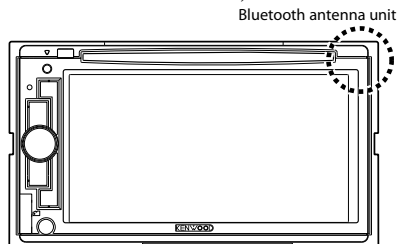

### CAUTION

Install this unit in the console of your vehicle. Do not touch the metal part of this unit during and shortly after the use of the unit. Metal part such as the heat sink and enclosure become hot.

# Connection

## Connector Function Guide

Pin Numbers for ISO Connectors	Cable Colour	Functions
External Power Connector		
A-4	Yellow	Battery
A-5	Blue/White	Power Control
A-6	Orange/White	Dimmer
A-7	Red	Ignition (ACC)
A-8	Black	Earth (Ground) Connection
Speaker Connector		
B-1	Purple	Rear Right (+)
B-2	Purple/Black	Rear Right (-)
B-3	Gray	Front Right (+)
B-4	Gray/Black	Front Right (-)
B-5	White	Front Left (+)
B-6	White/Black	Front Left (-)
B-7	Green	Rear Left (+)
B-8	Green/Black	Rear Left (-)

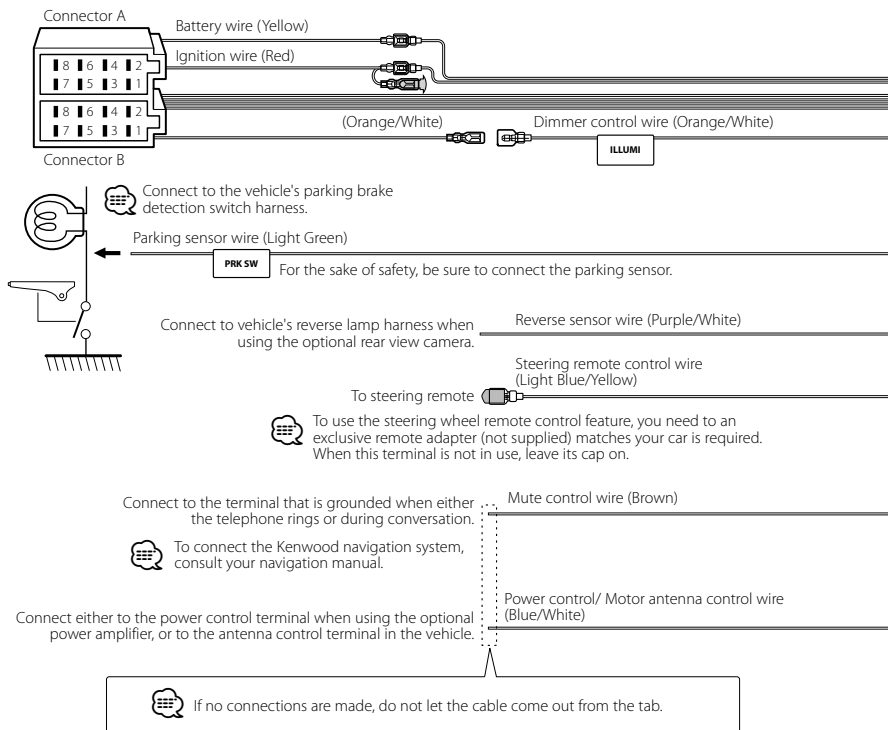
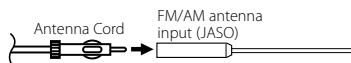

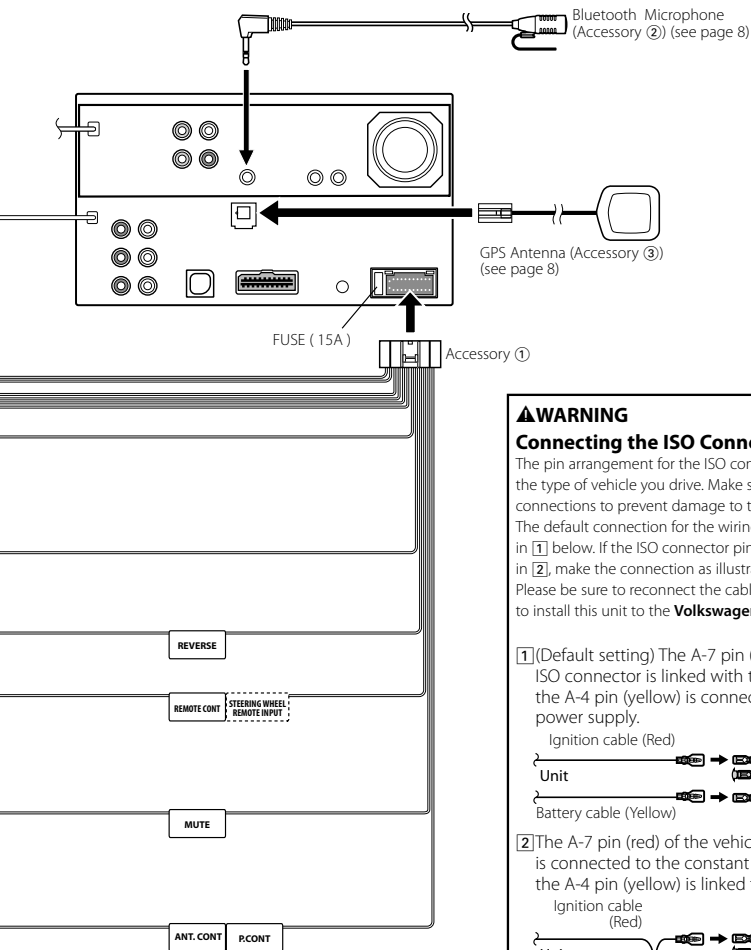

### ▲WARNING

#### Connecting the ISO Connector

The pin arrangement for the ISO connectors depends on the type of vehicle you drive. Make sure to make the proper connections to prevent damage to the unit.

The default connection for the wiring harness is described in [1] below. If the ISO connector pins are set as described in [2], make the connection as illustrated.

Please be sure to reconnect the cable as shown [2] below to install this unit to the **Volkswagen** vehicles etc.

[1] (Default setting) The A-7 pin (red) of the vehicle's ISO connector is linked with the ignition, and the A-4 pin (yellow) is connected to the constant power supply.

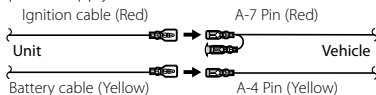

[2] The A-7 pin (red) of the vehicle's ISO connector is connected to the constant power supply, and the A-4 pin (yellow) is linked to the ignition.

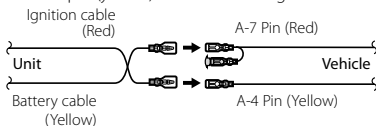

## System Connection

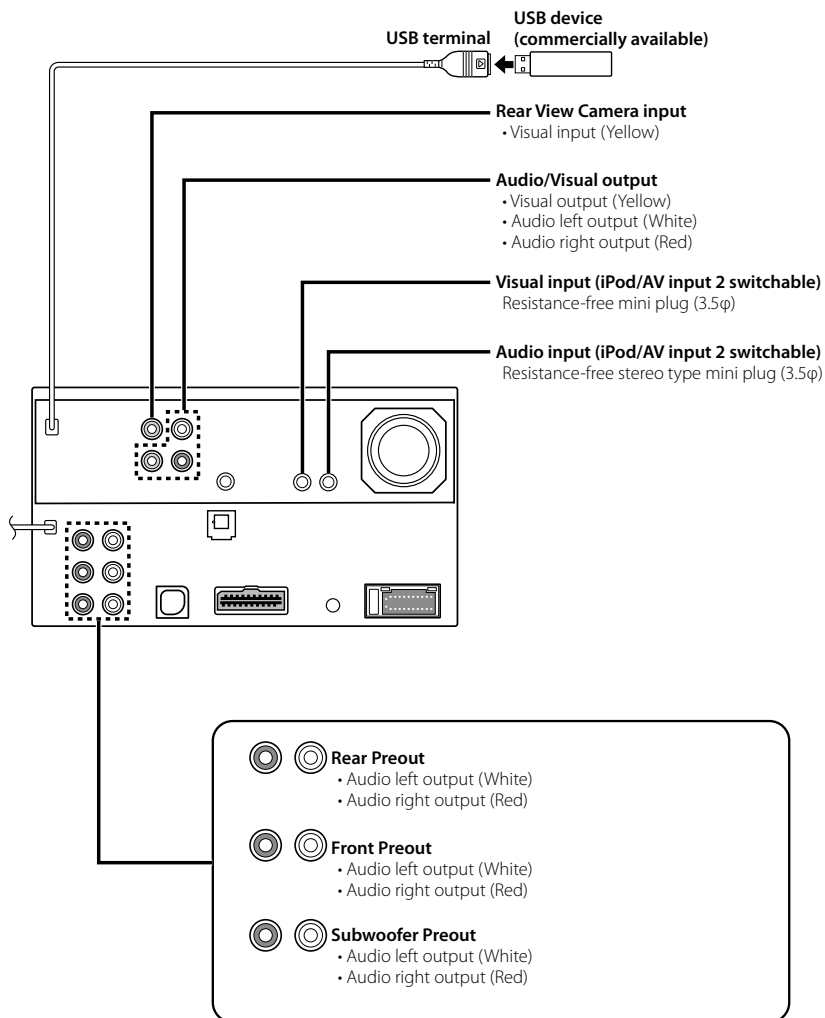

## Optional Accessory Connection

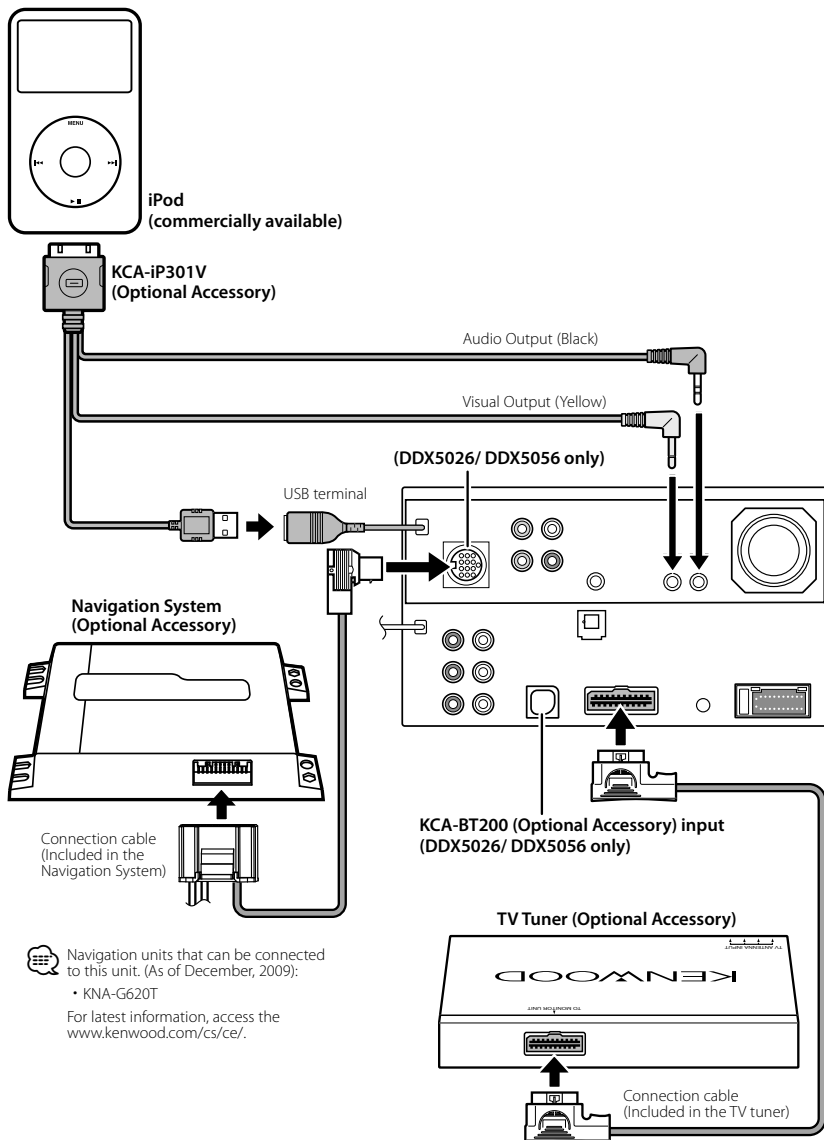

Navigation units that can be connected to this unit. (As of December, 2009):

- KNA-G620T

For latest information, access the [www.kenwood.com/cs/ce/](http://www.kenwood.com/cs/ce/).

## Installing the GPS Antenna (DNX5260BT only)

GPS antenna is installed inside of the car. It should be installed as horizontally as possible to allow easy reception of the GPS satellite signals.

### To mount the GPS antenna inside your vehicle:

1. Clean your dashboard or other surface.
2. Peel the backing off of the adhesive on the bottom of the metal plate (accessory ④).
3. Press the metal plate (accessory ③) down firmly on your dashboard or other mounting surface. You can bend the metal plate (accessory ④) to conform to a curved surface, if necessary.
4. Place the GPS antenna (accessory ③) on top of the metal plate (accessory ④).

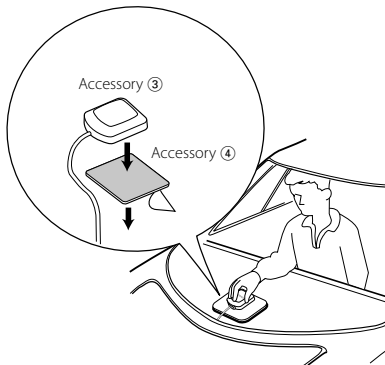

- Depending on the type of car, reception of the GPS satellite signals might not be possible with an inside installation.
- The GPS antenna should be installed at a position that is spaced at least 12 inch (30 cm) from cellular phone or other transmitting antennas. Signals from the GPS satellite may be interfered with by these types of communication.
- Painting the GPS antenna with (metallic) paint may cause a drop in performance.

## Installing the Microphone Unit (DNX5260BT only)

1. Check the installation position of the microphone (accessory ②).
2. Remove oil and other dirt from the installation surface.
3. Install the microphone.
4. Wire the cable up to the unit with it secured at several positions using tape or the like.

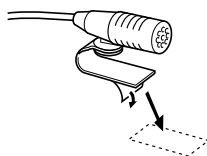
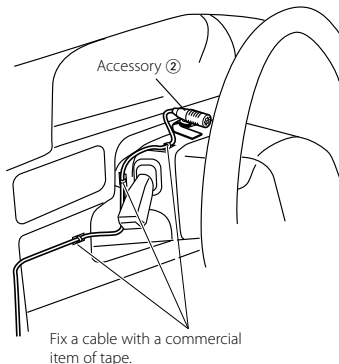

Peel the release coated paper of double-face adhesive tape to fix on the place shown above.



Adjust the direction of the microphone to the driver.



- Install the microphone as far as possible from the cell-phone.



## Installation for Monitor/Player Unit

### Installing the Escutcheon

1. Attach accessory ⑥ to the unit.

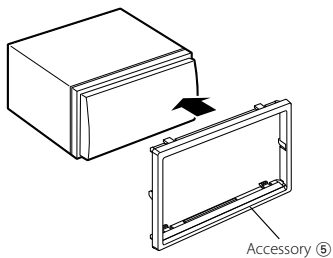

### Installing the Monitor/Player Unit

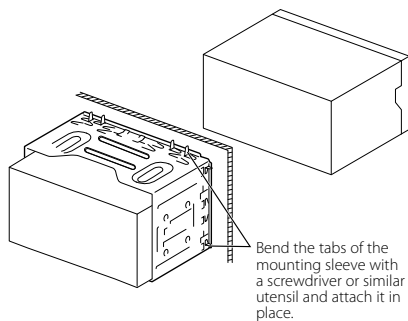

-  Make sure that the unit is installed securely in place. If the unit is unstable, it may malfunction (eg, the sound may skip).

## Removing Monitor/Player Unit

### Removing the Hard Rubber Frame (escutcheon)

1. Engage the catch pins on the removal tool ⑥ and remove the two locks on the lower level. Lower the frame and pull it forward as shown in the figure.

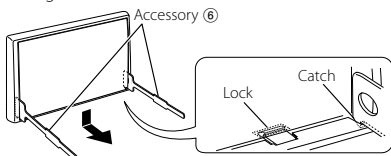

- The frame can be removed from the top side in the same manner.

2. When the lower level is removed, remove the upper two locations.

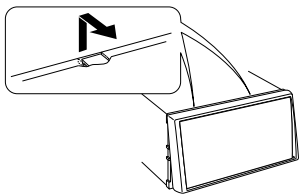

### Removing the Unit

1. Remove the hard rubber frame by referring to the removal procedure in the section <Removing the Hard Rubber Frame>.
2. Insert the two removal tools ⑥ deeply into the slots on each side, as shown.

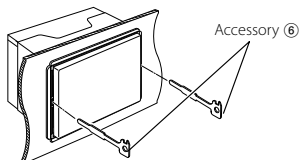

3. Lower the removal tool toward the bottom, and pull out the unit halfway while pressing towards the inside.

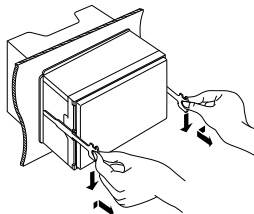

- Be careful to avoid injury from the catch pins on the removal tool.

4. Pull the unit all the way out with your hands, being careful not to drop it.

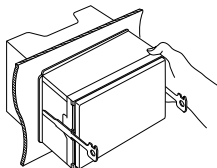



---

**KENWOOD**