

KENWOOD

DIGITAL MEDIA RECEIVER

KIV-BT900 KIV-700

INSTRUCTION MANUAL

Kenwood Corporation

Before reading this manual, click the button below to check the latest edition and the modified pages.



Take the time to read through this instruction manual.

Familiarity with installation and operation procedures will help you obtain the best performance from your new Digital Media-receiver.

For your records

Record the serial number, found on the back of the unit, in the spaces designated on the warranty card, and in the space provided below. Refer to the model and serial numbers whenever you call upon your Kenwood dealer for information or service on the product.

Model KIV-BT900/ KIV-700 Serial number _____

US Residents Only

Register Online

Register your Kenwood product at www.Kenwoodusa.com

Before Use

▲WARNING

To prevent injury or fire, take the following precautions:

- Do not watch or fix your eyes on the unit's display when you are driving for any extended period.
- To prevent a short circuit, never put or leave any metallic objects (such as coins or metal tools) inside the unit.

Do not use this unit before canceling Demonstration mode

This unit is initially set on the Demonstration mode. When using this unit for the first time, cancel the Demonstration mode. Refer to [<Exit of the Demonstration Mode>](#) (page 5).

- The demonstration is an operation image. It may be different from actual operation.

How to reset your unit

If this unit or the connected unit (auto disc changer, etc.) fails to operate properly, reset the unit. While pressing the [Volume] knob and the [MENU] button, press the [SRC] button for at least 3 seconds. The unit returns to factory settings when the reset operation is complete.

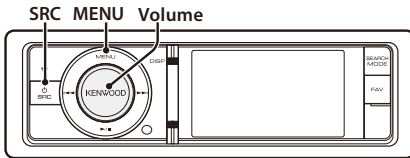

Cleaning the Unit

If the faceplate of this unit is stained, wipe it with a dry soft cloth such as a silicon cloth.

If the faceplate is stained badly, wipe the stain off with a cloth moistened with neutral cleaner, then wipe it again with a clean soft dry cloth.



- Applying spray cleaner directly to the unit may affect its mechanical parts. Wiping the faceplate with a hard cloth or using a volatile liquid such as thinner or alcohol may scratch the surface or erase characters.

Notes

- If you experience problems during installation, consult your Kenwood dealer.
- When you purchase optional accessories, check with your Kenwood dealer to make sure that they work with your model and in your area.
- Characters that conform to ISO 8859-1 can be displayed.
- The RDS or RBDS feature won't work where the service is not supported by any broadcasting station.
- The illustrations of the display and the panel appearing in this manual are examples used to explain more clearly how the controls are used. Therefore, what appears on the display in the illustrations may differ from what appears on the display on the actual equipment, and some of the illustrations on the display may be inapplicable.

Component Names and Functions

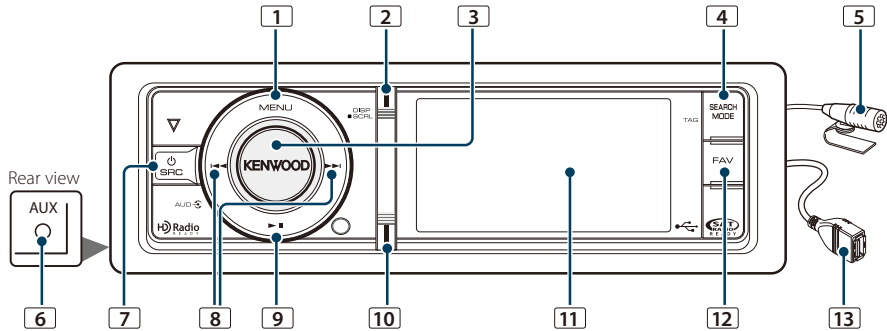

1 [MENU] button

To select a song or set functions. See [<Menu List Operation> \(page 5\)](#).

2 [DISP] button

To change display item (press the button).

3 [Volume] knob

To adjust volume (turn the knob).

To select menu setting item (turn and press the knob). See [<Menu List Operation> \(page 5\)](#) for details.

KIV-BT900 : To display Play mode in the Menu List (press the knob at least 1 second).

KIV-700 : To make a voice dialing call (press the knob at least 1 second). *1 See [<Make a Voice Dialing Call> \(page 33\)](#).

4 [SEARCH MODE] button

To enter Search mode (iPod), move between folders (Audio file), etc. For more details, see operations of each source described in page 6 or later.

5 Microphone (KIV-BT900)

The microphone for hands free phone is supplied.

When your voice cannot be recognized due to the low microphone volume or noises in the vehicle, adjust the microphone settings by [<Bluetooth Setting> \(page 50\)](#).

6 Auxiliary Input Terminal

Portable audio device can be connected with the mini-plug (3.5 mm \varnothing).

- Use the mini-plug cable which is stereo type and does not have any resistance.

7 [SRC] button

To turn on this unit and select the Source (press the button).

To turn off this unit (press the button at least 1 second).

8 [◀◀] / [▶▶] buttons

To select a station and song. (press the button).

9 [▶||] button

To start or interrupt playback for audio file and iPod. (press the button).

To select the remove mode, and remove the USB device or an iPod (press the button at least 2 seconds or more).

10 KIV-BT900: [📶] button

To enter Bluetooth mode (press the button).

To make a voice dialing call (press the button at least 1 second). See [<Make a Voice Dialing Call> \(page 33\)](#).

KIV-700: [PLAY MODE] button

To display Play mode in the Menu List (press the button). *1

11 Display window

12 [FAV] button

To recall a registered favorite item (press the button).

To register to Favorite (press the button at least 1 second).

13 USB Terminal

A USB device or an iPod can be connected.



*1 Only with KCA-BT300/BT200 (optional accessory) connected.

General Operation

Exit of the Demonstration Mode

Turn off the demonstration mode when you use it for the first time after installation.

- 1 Press the [Volume] knob to quit the demonstration mode when the message "To Cancel DEMO Press the volume knob" is displayed (approx. 15 seconds).
- 2 Turn the [Volume] knob to select "YES" and then press the [Volume] knob.

Power and Source Select

Turns the power ON by pressing the [SRC] button.

When the power is ON, select a source.

- SRC Select mode 1: Press the [SRC] button and then turn the [Volume] knob. To determine the selected source, press the [Volume] knob.
- SRC Select mode 2: Pressing the [SRC] button each time switches between sources. Tuner ("TUNER") → USB, iPod or Zune ("USB", "iPod", or "Zune") → Internal Memory ("Int. Mem.") → Auxiliary input ("AUX") → Standby ("STANDBY")

Keeping pressing the [SRC] button for at least 1 second turns the power OFF.



- The SRC Select mode can be set in "Source Select" of <Initial Settings> (page 38).
- Auxiliary input source is initially set to "OFF". Set "Built in AUX" described in <Initial Settings> (page 38) to "ON".
- When an optional accessory is connected, the source name for each device appears.
- When connection of the iPod is recognized, the source display changes from "USB" to "iPod", "Zune".
- Internal Memory source cannot be selected when "AV Out Set" described in <Initial Settings> (page 38) is set to "ON".

Volume

Turning the [Volume] knob adjusts the sound volume.

Menu List Operation

The basic operating procedure for using this function is described below. The individual function items are covered in the operating procedures.

1 Select the source

Press the [SRC] button. Turn the [Volume] knob and press it when the desired item is displayed.

Function items vary from source to source. For a list of the function items, refer to <Menu List> (page 68).

➤ SRC Select mode 2: Pressing the [SRC] button repeatedly also switches source.

2 Enter Menu List mode

Press the [MENU] button.

3 Select the setting item

Turn the [Volume] knob and press it when the desired item is displayed.

Repeat the operation until your desired setup item is selected.

➤ Press the [MENU] button to return to the previous item.

Operation example:

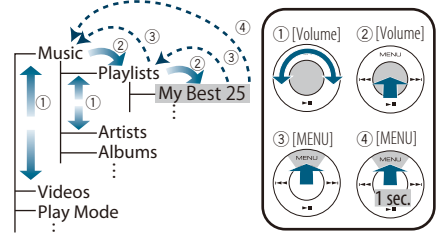

In this manual, the above selection is indicated as **Select "Music" > "Playlists" > "My Best 25"**.

4 Make a setting

Turn the [Volume] knob to select a setting value, and then press the [Volume] knob.

5 Exit Menu Setting mode

Press the [MENU] button for at least 1 second to return to the first hierarchy.

Press the [MENU] button in the first hierarchy to exit the Menu List mode.

iPod/iPhone Operation

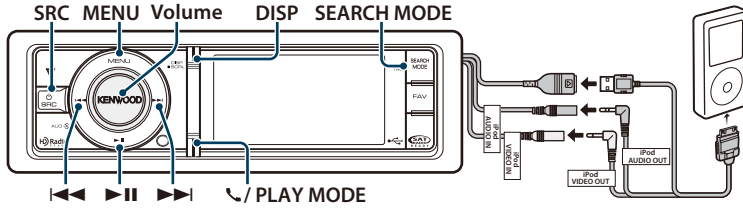

Basic Operation

Playing iPod

- **Connect an iPod**
When connected, the source is switched automatically and a song starts playing.
- **Select iPod source**
Press the [SRC] button. Turn the [Volume] knob and press it when the desired item is displayed.
Select the "iPod" display.
⚠ SRC Select mode 2: Pressing the [SRC] button repeatedly also switches source.

Song Select

- Press the [◀◀] or [▶▶] button.
⚠ This unit cannot be operated for a few seconds while reading Artwork after selecting a song.

Fast Forwards or Fast Backwards

Hold down the [◀◀] or [▶▶] button.

Pause and Play

Press the [▶||] button to pause or resume playback.

Remove iPod

- Press the [▶||] button for at least 2 seconds.
The unit enters the USB REMOVE mode ("USB REMOVE" is displayed), and the iPod can be removed safely.

USB Device select

iPod may not be recognized when USB HUB is used. Switch to the device to be connected.

1. **Enter Menu List mode**
Press the [MENU] button.
2. **Turn the [Volume] knob and press it when the desired item is displayed.**
Select "Port Up".
Repeat these steps to switch to the device to be connected.



- For more details on USB HUB, see <About USB device> (page 67).

Switching display

Press the [DISP] button to select display mode. Selects the Artwork small, Artwork large, Video or Clock.

- ⚠ The Video mode is displayed only when you have applied the parking brake.

Display example of Artwork small mode



- ① Song information (see <Customization of Display> (page 36))
- ② Play time and play time bar
- ③ Browse item
- ④ Album art
- ⑤ Play mode indicator (see <Display Indicator items> (page 71))

Selecting a Song by Browsing iPod

Display	Items
"Music"	
"Playlists"	Playlists
"Artists"	Artists
"Albums"	Albums
"Songs"	Songs
"Podcasts"	Podcasts
"Genres"	Genres
"Composers"	Composers
"Audiobooks"	Audio books
"Videos" ^{*1}	
"Video Playlists"	Video Playlists
"Movies"	Movies
"Music Videos"	Music Videos
"TV Shows"	TV Shows
"Video Podcasts"	Video Podcasts
"Rentals"	Rentals

*1 Name and number of items displayed in "Videos" are the same as the iPod.

1 Select iPod source

2 Enter Menu List mode

Press the [MENU] button.

3 Turn the [Volume] knob and press it when the desired item is displayed.

Select "Music" or "Videos".

4 Select a song

Operation type	Operation
Move between items	Turn the [Volume] knob.
Select an item	Press the [Volume] knob.
Page up or down	Press the [DISP] or [↶] / [PLAY MODE] button. Press the [DISP] or [↶] / [PLAY MODE] button for at least 1 second to continuously scroll. Press the button again to stop scrolling.
Return to previous item	Press the [MENU] button.
Return to Top menu	Press the [MENU] button for at least 1 second.

🔗 For example: Searching by Artist name.

Select "Music" > "Artists" > Artist name > Album name > Song title

Canceling the Menu List mode

Press the [MENU] button for at least 1 second, and then press it again briefly.



- The unit memorizes the position where you have found a song in the Search mode. When you enter the Menu List

mode after searching a song, the memorized position is displayed. Press the [MENU] button for at least 1 second to move to the first hierarchy, select a Menu item, and set its parameters.

- Characters which cannot be displayed are left blank. If non of the characters can be displayed, the browse item name and digits are displayed.

Items	Display	Items	Display
Playlists	"PLIST****"	Podcasts	"PDC****"
Artists	"ART****"	Genres	"GEN****"
Albums	"ALB****"	Composers	"COM****"
Songs	"PRGM****"		

"CAT****" "LIST****", or "PRGM****" may be displayed depending on the hierarchy of Video files folders.

iPod/iPhone Operation

Play Mode

You can select a Play Mode, such as Random play and Repeat play.

1 Select iPod source

2 Enter Play Mode in the Menu List

KIV-BT900: Press the [Volume] knob for at least 1 second.

KIV-700: Press the [PLAY MODE] button.

☞ You can also select from "Play Mode" in Menu List mode.

3 Select the Play Mode

Turn the [Volume] knob and press it when the desired item is displayed.

Display	Overview
"Play Mode"	
"iPod By Hand Mode"	When set to "ON", allows you to operate iPod with the control on the iPod. On <input checked="" type="checkbox"/> / Off <input type="checkbox"/>
"Folder Random"	When set to "ON", plays the music in the folder randomly. (Music only) On <input checked="" type="checkbox"/> / Off <input type="checkbox"/>
"All Random"	When set to "ON", plays all songs in iPod randomly. (Music only) On <input checked="" type="checkbox"/> / Off <input type="checkbox"/>
"File Repeat"	When set to "ON", plays the music repeatedly. On <input checked="" type="checkbox"/> / Off <input type="checkbox"/>

(: Factory setting)

4 Make a setting

Press the [Volume] knob.

5 Exit Menu List mode

Press the [MENU] button for at least 1 second, and then press it again briefly.

Remarks

• All Random

- The time required to turn on the all random function may become longer depending on the number of songs in iPod.
- Turning on the all random function changes the iPod browse item to "Songs". This browse item will not be changed even if the all random function is turned off.
- If the browse item is changed to search for music while the all random function is on, the all random function is turned off and the songs in the browse item are played at random.

• iPod By Hand Mode (iPod Control by Hand Mode)

Allows you to operate iPod with the control on the iPod.



- In the iPod Control by Hand Mode, controllable functions of iPod using this unit are those described in <Basic Operation>.

- This mode is not compatible with music information display. The display will show "iPod By Hand Mode".
- iPod can be operated when it conforms to the iPod control function.
- When you cancel the hand mode while playing a video file, the video file stops and a music file starts.

iPod Setting

You can select following iPod Setting items.

1 Select iPod source

2 Enter Menu List mode

Press the [MENU] button.

3 Turn the [Volume] knob and press it when the desired item is displayed.

Select "Settings".

4 Select the setting item

Turn the [Volume] knob and press it when the desired item is displayed.

Display	Overview
"Settings"	
"Skip Search"	Sets the ratio of skip performed with <Skip Search> (page 11). "0.5%"/"1%"/"5%"/"10%"
"Device F/W Version"	Display the version of the firmware of this unit.
"Delete My Playlist"	Deletes the registered My Playlist. Refer to <My Playlist> (page 12) for the operation. "Delete One"/"Delete All" → "YES"/"NO"
"Audiobook Speed"	Sets the audio book playback speed. "Slower"/"Normal"/"Faster"
"Sound Check"	Sets the sound volume of all songs to the same level. The sound volume adjustment is required using iTunes. "ON"/"OFF"

(__ : Factory setting)

5 Make a setting

Turn the [Volume] knob to select a setting value, and then press the [Volume] knob.

6 Exit Menu List mode

Press the [MENU] button for at least 1 second, and then press it again briefly.



- The setting of "Skip Search" in <iPod Setting> (page 9) and that in <USB Setting> (page 17) are always the same. Changing the setting of one reflects the other.

Selecting the Search Mode

You can select the most suited search method for the desired song.

Search mode in Normal playing

Display	Overview
"Direct Search"	You can quickly search the desired song by specifying its Search item (artist, album, etc.) and character. Refer to <Direct Search> (page 10).
"Related Search"	Searches for music of the same artist or genre as the one being played. (Music only) Refer to the <Related Search> (page 10).
"Recall My Playlist"	Registers a song to My Playlist and play it.
"Delete My Playlist"	Refer to <My Playlist> (page 12).
"Register My Playlist"	

Search mode in Browsing

Display	Overview
"Direct Search"	You can quickly search the desired song by specifying its Search item (artist, album, etc.) and character. Refer to <Direct Search> (page 10).
"Alphabet Search"	You can select an alphabetic character from the list in the browse item (artist, album, etc.) selected now. Refer to <Alphabet Search> (page 11).
"Skip Search"	The number of songs to be skipped is determined by the ratio of the total number of songs in the list which is selected now. Refer to <Skip Search> (page 11).
"Register My Playlist"	Registers a song to My Playlist. Refer to <My Playlist> (page 12).

1 Select iPod source

Press the [SRC] button. Turn the [Volume] knob and press it when the desired item is displayed.

Select the "iPod" display.

➤ SRC Select mode 2: Pressing the [SRC] button repeatedly also switches source.

2 Enter Search mode

Press the [SEARCH MODE] button.

➤ The search mode you can select changes depending on normal playback or browsing. For browsing operation, see <Selecting a Song by Browsing iPod> (page 7).

3 Select the Search mode

Turn the [Volume] knob.

4 Start the search mode

Press the [Volume] knob.

Canceling Search mode

Press the [SEARCH MODE] button.

iPod/iPhone Operation

Direct Search

You can quickly search the desired song by specifying its Search item (artist, album, etc.) and character.

1 Select iPod source

2 Enter Search mode

Press the [SEARCH MODE] button.

3 Enter Direct Search mode

Turn the [Volume] knob and press it when the desired item is displayed.

Select "Direct Search".

4 Select the browse item

Turn the [Volume] knob and press it when the desired browse item is selected.

Display	Items	Display	Items
"Music"		"Videos"*1	
"Playlists"	Playlists	"Video Playlists"	Video Playlists
"Artists"	Artists	"Movies"	Movies
"Albums"	Albums	"Music Videos"	Music Videos
"Songs"	Songs	"TV Shows"	TV Shows
"Podcasts"	Podcasts	"Video Podcasts"	Video Podcasts
"Genres"	Genres	"Rentals"	Rentals
"Composers"	Composers		
"Audiobooks"	Audio books		

*1 Name and number of items displayed in "Videos" are the same as the iPod.

5 Select the character to be searched for

Operation type	Operation
Move between items	Turn the [Volume] knob.
Select an item	Press the [Volume] knob.
Move to the next column	Press the [◀] or [▶] button.

Up to 3 characters can be entered.

6 Determine the selected character

Turn the [Volume] knob and press it when the desired item is displayed.

Select "DONE".

Start search. When the search is completed, the music search mode is selected again at the selected character position.

After this step, you need to browse. See step 4 of <Selecting a Song by Browsing iPod> (page 7) to select a song.

Canceling the Direct Search

Press the [SEARCH MODE] button.



- Characters that can be entered are alphabetical characters (A to Z), numerical characters (0 to 9), and " * ".
- " * " indicates characters other than alphabetical and numerical characters. You cannot enter any more characters when entering " * " in the first character position.
- If the first character string begins with an article "a", "an", or "the" in the Direct Search mode, it is searched for in defiance of the article.

Related Search

Searches for music of the same artist or genre as the one being played. (Music only)

1 Play the music in iPod

2 Press the [SEARCH MODE] button.

3 Enter Related Search mode

Turn the [Volume] knob and press it when the desired item is displayed.

Select "Related Search".

4 Select the browse item

Turn the [Volume] knob and press it when the desired browse item is selected.

Display	Browses music
"Search Artist"	Displays the album of the same artist.
"Search Album"	Displays music in the album in which the one being played is included.
"Search Genre"	Displays the artist of the same genre.
"Search Composer"	Displays the album including music created by the same composer.

After this step, you need to browse. See step 4 of <Selecting a Song by Browsing iPod> (page 7) to select a song.

Canceling the Related Search

Press the [SEARCH MODE] button.



- Related search cannot be performed while playing the video file.
- When the music being played has no information on browsing items or no music was found, "Not Found" is displayed.

Alphabet Search

You can select a song by alphabet. This function searches songs whose name contain the specified character(s) in the list of the selected Search item (artist, album, etc).

1 Select iPod source

2 Enter browsing mode

Press the [MENU] button.

Turn the [Volume] knob and press it when the desired item is displayed.

Select "Music" or "Videos" > category > brows item.

3 Enter Alphabet Search mode

Press the [SEARCH MODE] button.

Turn the [Volume] knob and press it when the desired item is displayed.

Select "Alphabet Search".

4 Search for item

Operation type	Operation
Select the character	Press the [DISP] or [] / [PLAY MODE] button.
Move between items	Turn the [Volume] knob.
Select an item	Press the [Volume] knob.
Return to previous item	Press the [MENU] button.

Canceling the Alphabet Search

Press the [SEARCH MODE] button.



- The time of search by alphabet may become long depending on the number of songs or items in iPod.
- If the first character string begins with an article "a", "an", or "the" in the Alphabet Search mode, it is searched for in defiance of the article.

Skip Search

You can scroll up or down according to the number of the selected Search items so that you can quickly switch the display position.

1 Select iPod source

2 Enter browsing mode

Press the [MENU] button.

Turn the [Volume] knob and press it when the desired item is displayed.

Select "Music" or "Videos" > category > brows item.

3 Enter Skip Search mode

Press the [SEARCH MODE] button.

Turn the [Volume] knob and press it when the desired item is displayed.

Select "Skip Search".

4 Search for item

Operation type	Operation
Move between items	Turn the [Volume] knob.
Select an item	Press the [Volume] knob.
Skip Search	Press the [DISP] or [] / [PLAY MODE] button. Keep pressing the button for 3 seconds or longer skips songs at 10% irrespective of the setting.
Sets the ratio of skip performed	Press the [◀◀] or [▶▶] button.
Return to previous item	Press the [MENU] button.

Canceling the Skip Search

Press the [SEARCH MODE] button.



- Set the ratio with "Skip Search" in <iPod Setting> (page 9).

iPod/iPhone Operation

My Playlist

Allows you to register your favorite songs in the Playlist of this unit. You can register up to 30 songs in the Playlist.

Registering Songs in the Playlist

1 Play the song you want to register

2 Press the [SEARCH MODE] button.

3 Register the song

Turn the [Volume] knob and press it when the desired item is displayed.

Select "Register My Playlist".

"## Stored (Registration number)" is displayed.



- Make a Playlist from the songs stored in one iPod. If you attempt to register a song stored in a different iPod, "No Information" appears and then "ALL Delete?" appears. Select "YES" to delete the Playlist when you want to remake it.
- The song displayed in the Music Search mode can be registered in the same manner. For how to use the music search function, refer to <Selecting a Song by Browsing iPod> (page 7).
- If you attempt to register the 31st song, "Memory Full" appears and you cannot register it accordingly. To register the song, delete an unnecessary song.
- Do not register Podcasts. Songs you do not want to register may be registered, or playback may not be carried out correctly.

Playing the Song in the Playlist

1 Press the [SEARCH MODE] button.

2 Enter My Playlist mode

Turn the [Volume] knob and press it when the desired item is displayed.

Select "Recall My Playlist".

3 Play the song in the Playlist

Turn the [Volume] knob and press it when the desired item is displayed.

Select the song you want to play.



- Turning ACC OFF or the power OFF cancels the My Playlist mode.
- The ending of a song may be cut unless the song has a silence of 1 second or longer at the end.
- Random play cannot be performed during playback of a song in the Playlist.

Deleting a Song from the Playlist

1 Press the [SEARCH MODE] button.

2 Enter Delete Playlist mode

Turn the [Volume] knob and press it when the desired item is displayed.

Select "Delete My Playlist".

3 Turn the [Volume] knob and press it when the desired item is displayed.

Select "Delete One" or "Delete All".

Selecting "Delete All" moves to step 5 and all songs are deleted.

4 Turn the [Volume] knob and press it when the desired item is displayed.

Select the song you want to delete.

5 Turn the [Volume] knob and press it when the desired item is displayed.

Select "YES".

"Completed" is displayed.



- You can also delete all songs from the Playlist by selecting "Delete My Playlist" described in <iPod Setting> (page 9).
- If you connect the different iPod from one registered to My Playlist, "Delete One" and "Delete All" will not appear and all songs be deleted.

USB device/ Zune/ Internal Memory Operation

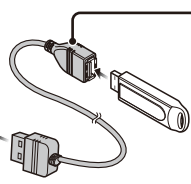
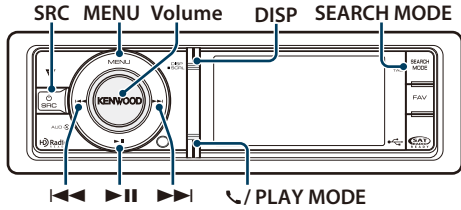

When connecting the USB device, usage of the CA-U1EX (option) is recommended.

Basic Operation

Playing USB device

- **Connect a USB device**
When connected, the source is switched automatically and a song starts playing.
- **Select USB/ Zune/ Internal memory source**
Press the [SRC] button. Turn the [Volume] knob and press it when the desired item is displayed.
Select the "USB", "Zune" or "Int.Mem." display.
⚡ SRC Select mode 2: Pressing the [SRC] button repeatedly also switches source.

Moving to the next folder (Except for Music Editor media or Zune)

Press the [SEARCH MODE] button.

Song Select

Press the [◀◀] or [▶▶] button.

Fast Forwards or Fast Backwards

Hold down the [◀◀] or [▶▶] button.

Pause and Play

Press the [▶||] button to pause or resume playback.

Remove USB device

Press the [▶||] button for at least 2 seconds.
The unit enters the USB REMOVE mode ("USB REMOVE" is displayed), and the USB device can be removed safely.

USB Device select

USB device may not be recognized when USB HUB is used. Switch to the device to be connected.

1. **Enter Menu List mode**
Press the [MENU] button.
2. **Turn the [Volume] knob and press it when the desired item is displayed.**
Select "Port Up".
Repeat these steps to switch to the device to be connected.

Multi card reader Drive Search

Selecting the device inserted in the Multi Card Reader.

1. **Enter Menu List mode**
Press the [MENU] button.
2. **Select a drive**
Turn the [Volume] knob and press it when the desired item is displayed.
Select "Drive Select" > "Drive#".

Switching display

Press the [DISP] button to select display mode.
Selects the Artwork small, Artwork large, Video or Clock.

⚡ The Video mode is displayed only when you have applied the parking brake.

Display example of Artwork small mode



- ① Song information (see <Customization of Display> (page 36))
- ② Play time and file number
- ③ File format indicator
- ④ Album art
- ⑤ Play mode indicator (see <Display Indicator items> (page 71))

About Internal Memory

Audio files, Video files or Picture files can be stored by copying from a USB device.

- **Built-in flash memory: 512 MB**

File Search

Selecting the file you want to listen to from the device being played now.

USB device/ Internal memory source

Display	Items
"USB List"/ "Internal Memory List"	Folder or file name list.

Music Editor media

Display	Items
"Music"	
"Playlists"	Playlists
"Artists"	Artists
"Albums"	Albums
"Songs"	Songs
"Genres"	Genres

Zune

Display	Items
"Music"	
"Genres"	Genres
"Artists"	Artists
"Albums"	Albums
"Songs"	Songs
"Playlists"	Playlists

1 Select USB/ Zune/ Internal memory source

2 Enter Menu List mode

Press the [MENU] button.

3 Turn the [Volume] knob and press it when the desired item is displayed.

Select "USB List", "Internal Memory List" or "Music".

4 Select a file

Operation type	Operation
Move between items	Turn the [Volume] knob.
Select an item	Press the [Volume] knob.
Page up or down	Press the [DISP] or [] / [PLAY MODE] button. Press the [DISP] or [] / [PLAY MODE] button for at least 1 second to continuously scroll. Press the button again to stop scrolling.
Return to previous item	Press the [MENU] button.
Return to Top menu	Press the [MENU] button for at least 1 second.

For example: Searching for ②.

Select "USB List" > [1] > [2] > ②

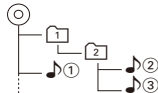

Canceling the Menu List mode

Press the [MENU] button for at least 1 second, and then press it again briefly.



- When you search a song in the File Search mode, the unit memorizes the position of the song being played after the search. To set a different Menu item after searching a song, press the [MENU] button for at least 1 second to move to the first hierarchy.

Remarks

Displaying picture files

- The playback of audio file continues even when a picture file is selected during playback. Pressing the [◀◀] or [▶▶] button switches between picture files.
- A picture cannot be displayed from the USB device that contains only picture files. Use the USB device that contains music or video files as well as picture files.

USB device/ Zune/ Internal Memory Operation

Function of Zune/ Music Editor media

Skip Search

You can scroll up or down according to the number of the selected Search items so that you can quickly switch the display position.

1 Select USB or Zune source

2 Enter File Search mode

Press the [MENU] button.

Turn the [Volume] knob and press it when the desired item is displayed.

Select "Music" > item.

3 Enter Skip Search mode

Press the [SEARCH MODE] button.

4 Search for item

Operation type	Operation
Move between items	Turn the [Volume] knob.
Select an item	Press the [Volume] knob.
Skip Search	Press the [DISP] or [] / [PLAY MODE] button. Keep pressing the button for 3 seconds or longer skips songs at 10% irrespective of the setting.
Sets the ratio of skip performed	Press the [◀◀] or [▶▶] button.
Return to previous item	Press the [MENU] button.

After this step, see step 4 of <File Search> (page 15) to select a song.

Canceling the Skip Search

Press the [SEARCH MODE] button.



- Set the ratio with "Skip Search" in <iPod Setting> (page 9).

Play Mode

You can select a Play Mode, such as Random play and Repeat play.

1 Select USB/ Zune/ Internal memory source

2 Enter Play Mode in the Menu List

KIV-BT900: Press the [Volume] knob for at least 1 second.

KIV-700: Press the [PLAY MODE] button.

☞ You can also select from "Play Mode" in Menu List mode.

3 Select the setting item

Turn the [Volume] knob and press it when the desired item is displayed.

Display	Overview
"Play Mode"	
"File Scan"	When set to "ON", plays the intro of the music in the folder successively. On "☑"/ Off "☐"
"Folder Random"	When set to "ON", plays the music in the folder randomly. On "☑"/ Off "☐"
"All Random"*1	When set to "ON", plays all songs in USB device randomly. On "☑"/ Off "☐"
"File Repeat"	When set to "ON", plays the music repeatedly. On "☑"/ Off "☐"
"Folder Repeat"*1	When set to "ON", plays the music in the folder repeatedly. On "☑"/ Off "☐"

(_ : Factory setting)

*1 Not selectable when Music Editor media or Zune is used.

4 Make a setting

Press the [Volume] knob.

5 Exit Menu List mode

Press the [MENU] button for at least 1 second, and then press it again briefly.

Direct Music Search

Searching the music by entering the file number.

1 Enter Direct Music Search mode

Press the [DIRECT] button on the remote control.

2 Enter the music number

Press the number buttons on the remote control.

3 Search the music

Press the [◀◀] or [▶▶] button.

Canceling Direct Music Search

Press the [DIRECT] button.



- Direct Music Search cannot be performed during playing of Zune/"Music Editor" media, Random play, or scan play.

USB Setting

You can select following USB Setting items.

1 Select USB source

2 Enter Menu List mode

Press the [MENU] button.

3 Turn the [Volume] knob and press it when the desired item is displayed.

Select "Settings".

4 Select the setting item

Turn the [Volume] knob and press it when the desired item is displayed.

Display	Overview
"Settings"	
"Skip Search"*1	Sets the ratio of skip performed with <Skip Search> (page 16). "0.5%"/"1%"/"5%"/"10%"
"Device F/W Version"	Display the version of the firmware of this unit.
"Device F/W Update"	Updates the firmware. The update information will be posted on the following URL as necessary. www.kenwood.com/cs/ce/

(_ : Factory setting)

*1 Selectable when Music Editor media or Zune is used.

5 Exit Menu List mode

Press the [MENU] button for at least 1 second, and then press it again briefly.



- The setting of "Skip Search" in <iPod Setting> (page 9) and that in <USB Setting> (page 17) are always the same. Changing the setting of one reflects the other.

USB device/ Zune/ Internal Memory Operation

Function of USB source

Copying from USB device

Copy files and folders from USB device to internal memory.

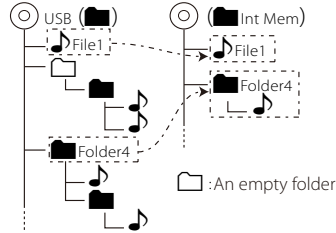

1 Select USB source

Press the [SRC] button. Turn the [Volume] knob and press it when the desired item is displayed.

Select the "USB" display.

⚙️ SRC Select mode 2: Pressing the [SRC] button repeatedly also switches source.

2 Enter Menu List mode

Press the [MENU] button.

3 Enter Copy mode

Turn the [Volume] knob and press it when the desired item is displayed.

Select "Copy from USB".

4 Select a file or folder to copy

Operation type	Operation
Move between items	Turn the [Volume] knob.
Select an item	Press the [Volume] knob.
High Speed Search	Press the [DISP] or [] / [PLAY MODE] button.
Return to previous item	Press the [MENU] button.
Return to Top menu	Press the [MENU] button for at least 1 second, and then press it again briefly.

5 Determine the selected file or folder

Press the [Volume] knob for at least 3 seconds.

6 Start copy

Turn the [Volume] knob and press it when the desired item is displayed.

Select "OK".

"Completed" is displayed when copying completes.

⚙️ Cancelling copy

1. Press the [Volume] knob.
2. Turn the [Volume] knob and press it when the desired item is displayed. Select "YES".

7 Exit Copy mode

Turn the [Volume] knob and press it when the

desired item is displayed.

Select "EXIT".

Returns to step 3 if "NEXT" is selected.



- If a folder is selected, the files in the folder are copied. Sub folders are not copied.
- If there is a file or folder with the same name, a message is displayed. If you select "OK", a number is added as "Name_001".
- If there is not enough space for the selected files or folders, "MEMORY OVER" is displayed. Reduce the number of files to copy or erase unnecessary files in the USB memory.
- If copying is canceled or if space runs out while copying, the files copied up to that point remain.
- The displayed space is a rough estimate. The actual size may be smaller or greater.
- Audio files with DRM can be copied, but cannot be played.
- Depending on the digital audio player, it may not be able to copy files.
- When files are copied from Music Editor media, the copied audio files are played as normal audio file. Song selection using the Music Editor media function is not possible.
- Files may be lost if the engine is started while copying.
- Copy with the engine running.
- The file in the internal memory cannot be copied to another media.
- If a Hands-Free phone call is received while copying files from the USB device, the copying stops.
- Only the following controls can be used while copying, or erasing:
 - Volume
 - Attenuator
 - Power off

When copying is interrupted

If ACC is turned off while copying, a screen to confirm whether to continue copying appears next time ACC is turned on (Resume function).

1 When "Continue USB Copy?" is displayed.

2 Turn on the engine and then select "YES".

3 Press the [Volume] knob.

Copying resumes.

Deleting Files in Memory

Deleting Files in Memory.

Display	Items
"Settings"	
"Internal Memory Delete"	Delete a folder or file.
"Internal Memory Format"	Perform format to delete all files stored in internal memory.

Internal Memory Format

1 Select Internal memory source

Press the [SRC] button. Turn the [Volume] knob and press it when the desired item is displayed.

Select the "Int.Mem." display.

↻ SRC Select mode 2: Pressing the [SRC] button repeatedly also switches source.

2 Enter Menu List mode

Press the [MENU] button.

3 Enter Internal memory Format mode

Turn the [Volume] knob and press it when the desired item is displayed.

Select "Settings" > "Internal Memory Format".

4 Turn the [Volume] knob and press it when the desired item is displayed.

Select "YES".

5 Exit Menu List mode

Press the [MENU] button for at least 1 second, and then press it again briefly.

Deleting file or folder

1 Select Internal memory source

2 Enter Menu List mode

Press the [MENU] button.

3 Enter Delete mode

Turn the [Volume] knob and press it when the desired item is displayed.

Select "Settings" > "Internal Memory Delete".

4 Select a file or folder to delete

Operation type	Operation
Move between items	Turn the [Volume] knob.
Select an item	Press the [Volume] knob.
High Speed Search	Press the [DISP] or [↵] / [PLAY MODE] button.
Return to previous item	Press the [MENU] button.
Return to Top menu	Press the [MENU] button for at least 1 second, and then press it again briefly.

5 Determine the selected file or folder

Press the [Volume] knob for at least 3 seconds.

6 Start deleting

Turn the [Volume] knob and press it when the desired item is displayed.

Select "OK".

"Completed" is displayed when deleting completes.

↻ Canceling delete

1. Press the [Volume] knob.

2. Turn the [Volume] knob and press it when the desired item is displayed.

Select "YES".

7 Exit Delete mode

Turn the [Volume] knob and press it when the desired item is displayed.

Select "EXIT".

Returns to step 4 if "NEXT" is selected.

USB device/ Zune/ Internal Memory Operation

Function of USB or Internal memory source

Picture File Viewing

You can select and view a picture file in the device.

1 Select USB or Internal memory source

2 Select a picture file

See <File Search> (page 15) and select a picture file to be displayed.

1. Press the [MENU] button.
2. Turn the [Volume] knob and press it when the desired item is displayed.
Select "USB List" or "Internal Memory List"
> folder > picture file.

To select a file

Press the [◀◀] or [▶▶] button.

Slide show

1 Enter Menu List mode

Press the [MENU] button.

⚠ If the first hierarchy is displayed at this step, skip step 2 and proceed to step 3.

2 Press the [MENU] button for at least 1 second to move to the first hierarchy.

3 Select the slide show

Turn the [Volume] knob and press it when the desired item is displayed.

Select "Slide" > "START" or "STOP".

4 Exit Menu List mode

Press the [MENU] button for at least 1 second, and then press it again briefly.

Canceling the picture file

Press the [DISP] button.



- The playback of audio file continues even when a picture file is selected during playback. Cancel your picture file viewing to operate audio files.
- If picture files are started to play while playing a video file, the video play stops.
- The Slide show is displayed only when you have applied the parking brake.

Function of USB or Internal memory source

Wallpaper Downloading

You can use downloaded picture for the display of this unit.

1 Connect the USB device

Connect the USB device containing the files to be downloaded into this unit.

⚠ A picture file can be downloaded from Internal memory.

2 Select files to be downloaded

See <File Search> (page 15) and select the picture file to be downloaded.

1. Press the [MENU] button.
2. Turn the [Volume] knob and press it when the desired item is displayed.
Select "USB List" or "Internal Memory List"
> folder > picture file.

3 Enter Menu List mode

Press the [MENU] button.

⚠ If the first hierarchy is displayed at this step, skip step 4 and proceed to step 5.

4 Press the [MENU] button for at least 1 second to move to the first hierarchy.

5 Start downloading

Turn the [Volume] knob and press it when the desired item is displayed.

Select "Save as Wallpaper".

When the downloading finishes, "Completed" is displayed.

6 Exit Menu List mode

Press the [MENU] button for at least 1 second, and then press it again briefly.

Setting the downloaded picture as wallpaper

Press [DISP] button to select Artwork small mode.

Set "Graphic Select" in <Customization of Display> (page 36).



- A wallpaper (picture file) cannot be downloaded during the slide show. Cancel the slide show, and then download a wallpaper.
- When a new wallpaper is downloaded, it will overwrite the currently downloaded wallpaper. There is no way to delete the downloaded pictures.

Disc Changer Control (Optional)

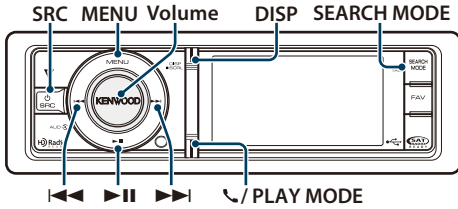

Basic Operation

Select CD changer source

Press the [SRC] button. Turn the [Volume] knob and press it when the desired item is displayed.

Select the "CD CH" display.

⚡ SRC Select mode 2: Pressing the [SRC] button repeatedly also switches source.

Moving to the next disc

Press the [SEARCH MODE] button.

Song Select

Press the [◀◀] or [▶▶] button.

Fast Forwards or Fast Backwards

Hold down the [◀◀] or [▶▶] button.

Pause and Play

Press the [||] button to pause or resume playback.

Switching display

Press the [DISP] button to select display mode.

Selects the Information or Clock.

Display example of information display mode

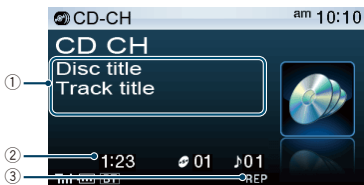

- ① Song information (see <Customization of Display> (page 36))
- ② Play time and track number
- ③ Play mode indicator (see <Display Indicator items> (page 71))

Play Mode

You can select a Play Mode, such as Random play and Repeat play.

1 Select CD changer source

2 Enter Play Mode in the Menu List

KIV-BT900: Press the [Volume] knob for at least 1 second.

KIV-700: Press the [PLAY MODE] button.

⚡ You can also select from "Play Mode" in Menu List mode.

3 Select the setting item

Turn the [Volume] knob and press it when the desired item is displayed.

Display	Overview
"Play Mode"	
"Track Scan"	When set to "ON", plays the intro of the music on the disc successively. On " <input checked="" type="checkbox"/> "/ Off " <input type="checkbox"/>
"Disc Random"	When set to "ON", plays the music on the disc randomly. On " <input checked="" type="checkbox"/> "/ Off " <input type="checkbox"/>
"Magazine Random"	When set to "ON", plays the music in the disc changer randomly. On " <input checked="" type="checkbox"/> "/ Off " <input type="checkbox"/>
"Track Repeat"	When set to "ON", plays the music repeatedly. On " <input checked="" type="checkbox"/> "/ Off " <input type="checkbox"/>
"Disc Repeat"	When set to "ON", plays the music on the disc repeatedly. On " <input checked="" type="checkbox"/> "/ Off " <input type="checkbox"/>

(_ : Factory setting)

4 Make a setting

Press the [Volume] knob.

5 Exit Menu List mode

Press the [MENU] button for at least 1 second, and then press it again briefly.

Function of remote control

Direct Music Search

Searching the music by entering the track number.

1 Enter Direct Music Search mode

Press the [DIRECT] button on the remote control.

2 Enter the music number

Press the number buttons on the remote control.

3 Search the music

Press the [◀◀] or [▶▶] button.

Cancelling Direct Music Search

Press the [DIRECT] button.



- Direct Music Search cannot be performed during playing of Random play or scan play.

Function of disc changer with remote control

Direct Disc Search

Searching the disc by entering the disc number.

1 Enter Direct Disc Search mode

Press the [DIRECT] button on the remote control.

2 Enter the disc number

Press the number buttons on the remote control.

3 Search the disc

Press the [FM+] or [AM-] button.

Cancelling Direct Disc Search

Press the [DIRECT] button.



- Direct Disc Search cannot be performed during Random play or scan play.
- Input "0" to select disc 10.

Tuner Operation

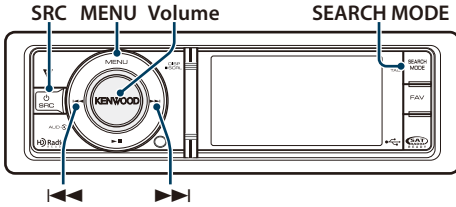

Basic Operation

Selecting Tuner source

Press the [SRC] button. Turn the [Volume] knob and press it when the desired item is displayed.

Select the "TUNER" display.

⚡ SRC Select mode 2: Pressing the [SRC] button repeatedly also switches source.

Selecting the Receiving Band

1. Enter Menu List mode

Press the [MENU] button.

2. Turn the [Volume] knob and press it when the desired item is displayed.

Select "FM1", "FM2", "FM3" or "AM".

Selecting the Receiving station

Press the [◀◀] or [▶▶] button.

⚡ Details of the station selecting in operation are set in the "Seek Mode" of <Tuner Setting> (page 24).

Switching display

Press the [DISP] button to select display mode.

Selects the Information or Clock.

Display example of information display mode



① Station information (see <Customization of Display> (page 36))

② Status indicator (see <Display Indicator items> (page 71))

Tuner Setting

You can select following Tuner Setting items.

1 Select Tuner source

2 Enter Menu List mode

Press the [MENU] button.

3 Turn the [Volume] knob and press it when the desired item is displayed.

Select "Settings".

4 Select the setting item to adjust

Turn the [Volume] knob and press it when the desired item is displayed.

Display	Overview
"Settings"	
"Seek Mode"	Selects the tuning mode of the radio. "Auto1": Automatic search for a station. "Auto2": Search in order of the stations in the Preset memory. "Manual": Normal manual tuning control.
"Auto Memory"	Memorizes 6 stations with good reception automatically. "YES"/"NO"
"TI"	Switches to the traffic information automatically when the traffic bulletin starts. "ON"/"OFF"
"TAG Memory"	Displays the tag memory usage of RDS station receiver. Up to 50 tags can be registered to this unit. "##/50"
"Tagging"	Turns ON / OFF the tag memory function of RDS station receiver. "ON"/"OFF"
"Forced MONO"	Reduces the noise when stereo broadcasts are received as monaural. "ON"/"OFF"

(_ : Factory setting)

5 Make a setting

Turn the [Volume] knob to select a setting value, and then press the [Volume] knob.

6 Exit Menu List mode

Press the [MENU] button for at least 1 second, and then press it again briefly.

Remarks

• Forced MONO

Strong electrical fields (such as from power lines) may cause unstable sound quality when it is set to ON. In such a situation, turn it OFF.

• Traffic information (TI)

Turns ON or OFF the Traffic Information function. When the function is set to ON, "TI" indicator is ON. If traffic bulletin starts when the function is ON,

"Traffic INFO" is displayed and traffic information is received.

If the volume is adjusted during reception of traffic information, the adjusted volume is memorized automatically. The memorized volume will be applied next time the Traffic Information function is turned ON.

Station Preset Memory

Putting a station in the memory.

- 1 Select the radio band and tune in a desired radio station you wish to store in the preset memory**
- 2 Enter Menu List mode**
Press the [MENU] button.
- 3 Enter Preset Memory mode**
Turn the [Volume] knob and press it when the desired item is displayed.
Select "List & Memory".
- 4 Select the number to put in the memory**
Turn the [Volume] knob and press it for at least 2 seconds when the desired item is displayed.
Select a preset number.

Display	Overview
"List & Memory"	
"-1"	Preset number 1.
"-2"	Preset number 2.
⋮	
"-6"	Preset number 6.

Auto Memory Entry

Putting stations with good reception in the memory automatically.

- 1 Select the radio band you wish to store in the preset memory**
- 2 Enter Menu List mode**
Press the [MENU] button.
- 3 Enter Auto Memory Entry mode**
Turn the [Volume] knob and press it when the desired item is displayed.
Select "Settings" > "Auto Memory".
- 4 Open Auto Memory Entry**
Turn the [Volume] knob and press it when the desired item is displayed.
Select "YES".
When 6 stations that can be received are put in the memory, auto memory entry closes.

Preset Tuning

Recalling the stations in the memory.

- 1 Select the radio band**
- 2 Select a desired station in the memory**
Turn the [Volume] knob and press it when the desired item is displayed.
Select "List & Memory" > Preset number.

Tuner Operation

Function of remote control

Direct Access Tuning

Tuning in a desired radio station by entering the frequency.

1 Select the radio band

2 Enter Direct Access Tuning mode

Press the [DIRECT] button on the remote control.

"- - - -" is displayed.

3 Enter the frequency

Press the number buttons on the remote control.

Example:

Desired frequency	Press button
92.1 MHz (FM)	[9], [2], [1]
810 kHz (AM)	[8], [1], [0]

4 Tune in to the entered frequency

Press the [◀◀] or [▶▶] button.

Canceling Direct Access Tuning

Press the [DIRECT] button on the remote control.

iTunes Tagging

Using an iTunes Tagging enabled RDS station receiver you can tag your music. When you hear a song you enjoy on your local RDS station, you only have to press the [SEARCH MODE] button. The song's information will then be saved on this unit. The saved songs will then show up in a playlist called "Tagged" in iTunes the every next time you sync your iPod to your computer. So then you just need to click and then easily buy and download the song you were tagging directly from the Apple iTunes Music Store.

1 Enter iTunes tagging mode

Press the [SEARCH MODE] button.

"TAG" will be displayed when song information can be registered.



- Turn "ON" the "TAGGING" of <Tuner Setting> (page 24) when using this function.
- Up to 50 TAGs (song's information) can be registered to this unit. When iPod is connected, the TAG information registered to this unit is transferred to the connected iPod.
- The memory usage can be checked by selecting "TAG MEMORY" of <Tuner Setting> (page 24).

PTY (Program Type)

Selecting the Program Type below and searching for a station.

Program Type	Display	Program Type	Display
Speech	"Speech"	Soft	"Soft"
Music	"Music"	Nostalgia	"Nostalga"
News	"News"	Jazz	"Jazz"
Information	"Inform"	Classical	"Classicl"
Sports	"Sports"	R & B	"R & B"
Talk	"Talk"	Soft R & B	"Soft R&B"
Rock	"Rock"	Language	"Language"
Classic Rock	"Cls Rock"	Religious Music	"Rel Musc"
Adult Hits	"Adlt Hit"	Religious Talk	"Rel Talk"
Soft Rock	"Soft Rck"	Personality	"Persnlty"
Top 40	"Top 40"	Public	"Public"
Country	"Country"	College	"College"
Oldies	"Oldies"	Weather	"Weather"

- Speech and Music include the Program type shown below.

Speech: Items in the white letters.

Music: Items in the black letters.

1 Enter Menu List mode

Press the [MENU] button.

2 Select the FM band

Turn the [Volume] knob and press it when the desired item is displayed.

Select "FM1", "FM2", or "FM3".

3 Enter Menu List mode

Press the [MENU] button.

4 Enter PTY mode

Turn the [Volume] knob and press it when the desired item is displayed.

Select "PTY Search".

5 Select the Program Type

Turn the [Volume] knob.

6 Search for the selected Program Type station

Press the [◀◀] or [▶▶] button.

7 Exit PTY mode

Press the [MENU] button for at least 1 second, and then press it again briefly.



- This function cannot be used during a traffic bulletin or AM reception.
- When the selected Program Type is not found, "No PTY" is displayed. Select another Program Type.
- The operation ends automatically if you do not operate within 30 seconds.

Program Type Preset

Putting the Program Type in the Preset button memory and quick recall.

Presetting the Program Type

1 Select the Program Type to preset

Refer to <PTY (Program Type)> (page 27).

2 Enter Program Type Preset mode

Press the [SEARCH MODE] button.

3 Select the number to put in the memory

Turn the [Volume] knob and press it for at least 2 seconds when the desired item is displayed.

Select the preset number.

Recalling the preset Program Type

1 Enter PTY mode

Refer to <PTY (Program Type)> (page 27).

2 Enter Program Type Preset mode

Press the [SEARCH MODE] button.

3 Select a desired Program Type in the memory

Turn the [Volume] knob and press it when the desired item is displayed.

Select the preset number.

Bluetooth Audio Operation

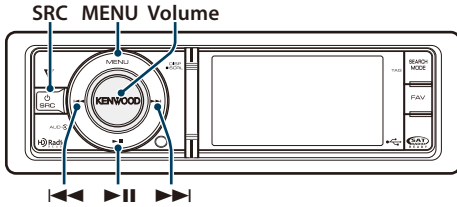

Connecting a Bluetooth Device

Before using the Bluetooth device, you need to connect Bluetooth device to this unit.

Pairing (Registering from Bluetooth devices)

To make your Bluetooth Audio player usable with this unit, you need to register it (pairing).

1 Turn on this unit

Press the [SRC] button.

2 Start registering this unit by operating the Bluetooth device

By operating the Bluetooth device, register the audio player (pairing). Select "KCA-BT300"/"KCA-BT200" from the list of connected units.

3 Enter a PIN code

Input the PIN code ("0000") in the Bluetooth device.

Check that registration is complete on the Bluetooth device.

✎ PIN code is set to "0000" as the default. You can change this code. Refer to <Registering PIN Code> (page 52).

4 By operating the Bluetooth device, start Bluetooth connection.



- If pairing does not succeed, try followings.
 - PIN code is set to "0000". See <Registering PIN Code> (page 52).
 - Turn off the power of this unit and turn it back on. And then try the pairing operation again.
 - If other audio players have been registered, delete them. And then try the pairing operation again. See <Deleting a Registered Bluetooth Device> (page 53).
- When registering from this unit, refer to <Registering Bluetooth Device> (page 51).
- For details on the Bluetooth Audio player which can be connected, see <About the Bluetooth Audio player> in the instruction manual of the Bluetooth Unit.

Basic Operation

Selecting Bluetooth Audio source

Press the [SRC] button. Turn the [Volume] knob and press it when the desired item is displayed.

Select the "BT AUD EXT" display.

✎ SRC Select mode 2: Pressing the [SRC] button repeatedly also switches source.

Pause and play

Press the [▶||] button.

Music Search

Press the [◀◀] or [▶▶] button.

Switching display

Press the [DISP] button to select display mode.

Selects the Information or Clock.

Display example of information display mode



① Song information*1

(Only with KCA-BT300 (optional accessory) connected)



- *1 If the Bluetooth Audio player supports AVRCP1.3 profile, these items can be displayed.
- All or some of the operations above cannot be performed if the Bluetooth audio player is not ready for remote control.
- Switching between Bluetooth audio sources does not start or stop playback automatically. Perform the operation for starting or stopping playback.
- Some audio players cannot be controlled remotely or reconnected after Bluetooth disconnection. Operate the main unit of the audio player to connect Bluetooth.

Operation of Hands-Free Phoning

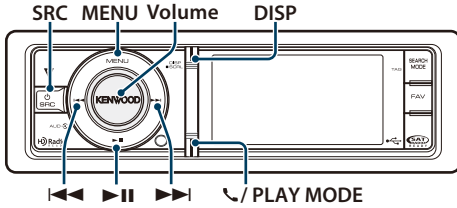

Connecting a Bluetooth Device

Before using the Bluetooth device, you need to connect Bluetooth device to this unit. The following 3 steps procedure is necessary.

Step 1. Pairing (Registering from Bluetooth devices)

To make your Bluetooth device (cell-phone) usable with this unit, you need to register it (pairing).

1 Turn on this unit

Press the [SRC] button.

2 Start registering this unit by operating the Bluetooth device

By operating the Bluetooth device, register the hands-free unit (pairing). Select "KENWOOD BT USB/R-3P1"/"KCA-BT300"/"KCA-BT200" from the list of connected units.

3 Enter a PIN code

Input the PIN code ("0000") in the Bluetooth device.

Check that registration is complete on the Bluetooth device.

➤ PIN code is set to "0000" as the default. You can change this code. Refer to <Registering PIN Code> (page 52).

4 By operating the Bluetooth device, start hands-free connection.

Step 2. Connection

If you have registered 2 or more cell-phones, you need to select one of them. For more details, see <Selecting the Bluetooth Device You Wish to Connect> (page 52).

When a cell-phone is connected, the "BT" indicator is light up.

Step 3. Hands-free phoning

You can do hand-free phoning when the connection is made.



- When registering from this unit, refer to <Registering Bluetooth Device> (page 51).
- For details on the Bluetooth cell-phone with the hands-free function, see <About the Cell-Phone> (page 67).

Receiving a Call

Answering a Phone Call

Press the [Volume] knob.



- The following operations disconnect the line:
 - Connect a USB device.
- The name of the calling party is displayed if it has already been registered in the Phone Book.

Rejecting an Incoming Call

Press the [SRC] button or press the [PHONE] / [PLAY MODE] button for at least 1 second.

During a Call

Disconnecting a Call

Press the [SRC] button or press the [PHONE] / [PLAY MODE] button for at least 1 second.

Switching to the Private Mode

Press the [PAUSE] button.

Switches between Private talk ("PRIVATE") and Hands-free talk each time this button is pressed.



- Depending on the type of your cell-phone, switching to the private talk mode may select the source that was used before commencing the hands-free connection. If this happens, the source cannot be switched back to the hands-free talk mode by operating this unit. Operate your cell-phone to return to the hands-free talk mode.

Adjusting the Voice Volume during a Call

Turn the [Volume] knob.

Call Waiting

Answering Another Incoming Call with the Current Call Suspended

Turn the [Volume] knob and press it when the desired item is displayed.
Select "Answer".

Answering another Incoming Call after Terminating the Current Call

Press the [SRC] button or press the [📞] / [PLAY MODE] button for at least 1 second.

Continuing the Current Call

Turn the [Volume] knob and press it when the desired item is displayed.
Select "Reject".

Answering the Waiting Call after Terminating the Current Call

Press the [SRC] button or press the [📞] / [PLAY MODE] button for at least 1 second.

Switching between the Current Call and Waiting Call

Press the [Volume] knob.
Each pressing of this knob switches the calling party.

Other Functions

Clearing the Disconnection Message

KIV-BT900: Press the [📞] button.
KIV-700: Press the [PLAY MODE] button for at least 1 second.
"HF Disconnect" disappears.

Making a Call







1 Enter Bluetooth mode

KIV-BT900: Press the [📞] button.

KIV-700: Press the [PLAY MODE] button for at least 1 second.

2 Select a dialing method

Turn the [Volume] knob and press it when the desired item is displayed.

Display	Overview
 "Preset Call"	Calling a number in the preset.
 "Phonebook"	Selecting the character to be searched for the phone book.
 "In Call"	Calling a number in the incoming call list.
 "Out Call"	Calling a number in the outgoing call list.
 "Missed Call"	Calling a number in the missed calls list.
 "Number Dial"	Making a call by entering phone number.

Operation method of each mode is described below.

3 Exit the dialing method mode

KIV-BT900: Press the [📞] button.

KIV-700: Press the [PLAY MODE] button for at least 1 second.

Speed Dialing (Preset Dial)

1 Enter Bluetooth mode

KIV-BT900: Press the [📞] button.

KIV-700: Press the [PLAY MODE] button for at least 1 second.

2 Select the preset dial mode

Turn the [Volume] knob and press it when the desired item is displayed.
Select "Preset Call".

3 Select the number you want to recall from the memory

Turn the [Volume] knob and press it when the desired item is displayed.
Select the preset number.
Phone number is displayed.

4 Make a call

Press the [Volume] knob.



- You need to register the preset dial number. Refer to [<Registering to the Preset Dial Number List> \(page 33\)](#).

Operation of Hands-Free Phoning

Calling a Number in the Phone Book

1 Enter Bluetooth mode

KIV-BT900: Press the [📶] button.

KIV-700: Press the [PLAY MODE] button for at least 1 second.

2 Select the Phone Book mode

Turn the [Volume] knob and press it when the desired item is displayed.
Select "Phonebook".

3 Select the character to be searched for

Operation type	Operation
Move to the next character.	Turn the [Volume] knob.
Determine the selected character.	Press the [Volume] knob.

4 Select the name or phone number

Turn the [Volume] knob.

↗ Switching between Display Modes

Press the [DISP] button.

Pressing this button each time switches between name and telephone number.

5 Make a call

Press the [Volume] knob.



- During search, a non-accent character such as "u" is searched for instead of an accent character such as "ü".

Calling a Number in the Call log

1 Enter Bluetooth mode

KIV-BT900: Press the [📶] button.

KIV-700: Press the [PLAY MODE] button for at least 1 second.

2 Select the call log mode

Turn the [Volume] knob and press it when the desired item is displayed.
Select "Out Call" (outgoing call), "In Call" (incoming call), or "Missed Call" (missed call).

3 Select a name or phone number

Turn the [Volume] knob.

↗ Switching between Display Modes

Press the [DISP] button.

Pressing this button each time switches between name and telephone number.

4 Make a call

Press the [Volume] knob.



- The outgoing call list and the incoming call list, and the missed call list are the lists of calls originated from and received at this unit. They are not the ones stored in the cell-phone memory.

Dial a Number

1 Enter Bluetooth mode

KIV-BT900: Press the [📶] button.

KIV-700: Press the [PLAY MODE] button for at least 1 second.

2 Select the number dial mode

Turn the [Volume] knob and press it when the desired item is displayed.
Select "Number Dial".

3 Enter a phone number

Operation type	Operation
Select the numbers.	Turn the [Volume] knob.
Move to the next digit.	Press the [▶▶] button.
Delete the last digit.	Press the [◀◀] button.

- Press the number ([1] – [0]), #[([FM])], *([AM]), or +([▶▶]) button on the remote controller.

↗ To erase the entered phone number digit by digit:

Press the [◀◀] button on the remote controller.

4 Make a call

- Press the [Volume] knob.
- Press the [DIRECT] button on the remote controller.



- You can input max 25 (KIV-BT900)/ 32 (KIV-700) digits.

Make a Voice Dialing Call

1 Enter voice recognition mode

KIV-BT900: Press the  button for at least 1 second.

KIV-700: Press the [VOL] button for at least 1 second.

2 "Phonebook Name?" is displayed.

When a beep is heard, say the name within 2 seconds.

3 "Phonebook Type?" is displayed.

When a beep is heard, say the category name within 2 seconds.

4 Make a call

Press the [Volume] knob.

 This step is the same as step 4 of the procedure in <Calling a Number in the Phone Book> (page 32). You can make a call or select a category.



- If your voice cannot be recognized, a message is displayed. Pressing the [Volume] knob allows you to retry voice input. Refer to <Troubleshooting Guide> (page 80).
- Both the name and category require registration of a voice tag. Refer to <Setting a Voice Command for Category> (page 55).
- Audio sound is not output during voice recognition.

Registering to the Preset Dial Number List

1 Select the phone number you wish to register

Select the phone number with reference to the following:

- Calling a Number in the Phone Book (page 32)
- Calling a Number in the Call log (page 32)
- Dial a Number (page 32)

2 Enter Preset Memory mode

Press the [Volume] knob for at least 2 seconds.

3 Select the preset number to put in the memory

Turn the [Volume] knob.
Select the preset number.

4 Determine the preset number to put in the memory





Press the [Volume] knob for at least 2 seconds.

Exit the Preset Memory mode

Press the [MENU] button.

Display of Phone Number Type (category)

The category items in the Phone Book are displayed as follows:

Display	Information
"General" / "  "	General
"Home" / "  "	Home
"Office" / "  "	Office
"Mobile" / "  "	Mobile
"Other" / "  "	Other

Display Settings

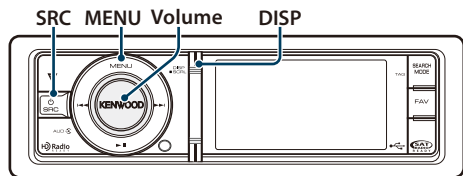

Basic Operation

Switching display

Press the [DISP] button.

Mode	Display Type
Artwork small	Displays song information. (Only for iPod/ USB/ Zune/ Internal Memory source)
Artwork large	Displays artwork and song information, etc., separately. (Only for iPod/ USB/ Zune/ Internal Memory source)
Video*1	Displays video of a video file. (Video file only)
Information	Displays station information, etc. (Except for iPod/ USB/ Zune/ Internal Memory source)
Clock	Displays the clock.

*1 The Video mode is displayed only when you have applied the parking brake.

Text scroll

Press the [DISP] button for at least 1 second.

The displayed text scrolls.

Display Setting

You can select following Display Setting items.

1 Select the source

Press the [SRC] button. Turn the [Volume] knob and press it when the desired item is displayed.

🔊 SRC Select mode 2: Pressing the [SRC] button repeatedly also switches source.

2 Enter Menu List mode

Press the [MENU] button.

3 Enter Display Setting mode

Turn the [Volume] knob and press it when the desired item is displayed.

Select "Settings" > "Display & Illumination".

4 Select the setting item to adjust

Turn the [Volume] knob and press it when the desired item is displayed.

Display	Overview
"Settings"	
"Display & Illumination"	Making Display and Illumination settings.
"Display Select"	Selecting and customizing the Display type.
"Display Off Mode"	If this unit is not operated at least 5 seconds with "OFF" selected, the display turns off. During a setup mode, the display will not turn off even if 5 seconds lapse. "ON"/"OFF"
"Display Dimmer"	Reduces the display Illumination brightness. "Auto": Dims the illumination in conjunction with the Light switch of the vehicle. "OFF": Does not dim the illumination.
"Text Scroll"	Specifies whether the text is scrolled automatically. "Auto"/"Manual"
"Key Color Select"	Selecting the Illumination Color of the panel. Refer to <Illumination Color Selection> (page 35).
"Key ILLUMI Dimmer"	Reduces the key Illumination brightness. "Auto": Dims the illumination in conjunction with the Light switch of the vehicle. "Manual1": Dims the illumination constantly. "Manual2": Dims the illumination darker than Manual 1. "OFF": Does not dim the illumination.
"ILLUMI Effect"	Sets whether the key illumination brightness is changed in conjunction with the key operation. "ON"/"OFF"
"ILLUMI Music SYNC"	Sets whether the key illumination brightness is changed in conjunction with the sound volume. "ON"/"OFF"
"Aspect Set"*1	Sets the aspect ratio of video files. "Full": Displays in Wide screen by 16:9 aspect ratio. "Normal": Displays in Standard screen by 4:3 aspect ratio.
"Monitor Setup"	
"Brightness"	Adjusting the display Brightness. "-3" - "0" - "+3"
"Contrast"	Adjusting the display contrast. "-3" - "0" - "+3"

(_ : Factory setting)

*1 Only for iPod/ USB/ Internal Memory source.

5 Make a setting

Turn the [Volume] knob to select a setting value, and then press the [Volume] knob.

6 Exit Menu List mode

Press the [MENU] button for at least 1 second, and then press it again briefly.

Illumination Color Selection

Selecting the Illumination Color of the panel.

1 Enter Menu List mode

Press the [MENU] button.

2 Enter Illumination color selection mode

Turn the [Volume] knob and press it when the desired item is displayed.

Select "Settings" > "Display & Illumination" > "Key Color Select".

3 Select the Illumination Color

Turn the [Volume] knob and then press the [Volume] knob when the desired item is displayed.

Select the color from "Variable Scan"/"Color1" — "Color 10"/"User".

Creating "User" color

You can create your original color during the selection from "Color1" — "Color10".

The color you created can be called when you select "User".

1. Press the [Volume] knob for at least 1 second.

Enter the detail color adjustment mode.

2. Turn the [Volume] knob and press it when the desired item is displayed.

Select the color to adjust. (red, green, or blue).

3. Turn the [Volume] knob to adjust color (Range: 0 – 9), and then press the [Volume] knob.

4. Press the [Volume] knob for at least 1 second.

Exit the detail color adjustment mode.

4 Exit Menu List mode

Press the [MENU] button for at least 1 second, and then press it again briefly.

Customization of Clock Display

You can customize the display of the Clock Display mode.

1 Select the source

Press the [SRC] button. Turn the [Volume] knob and press it when the desired item is displayed.

➡ SRC Select mode 2: Pressing the [SRC] button repeatedly also switches source.

2 Enter Menu List mode

Press the [MENU] button.

3 Enter Display Setting mode and Select the Clock Display

Turn the [Volume] knob and press it when the desired item is displayed.

Select "Settings" > "Display & Illumination" > "Display Select" > "Type Select" > Clock Display.

4 Select the setting item to adjust

Turn the [Volume] knob and press it when the desired item is displayed.

Display	Setting
"Display Select"	
"Type Select"	Selects the Clock Display mode.
"Text Select"	Sets the text display.
"Graphic Select"	Switches between single and dual clock and between analog and digital display.

5 Make a setting

Turn the [Volume] knob to select a setting value, and then press the [Volume] knob.

6 Exit Menu List mode

Press the [MENU] button for at least 1 second, and then press it again briefly.

Display Settings

Customization of Display

You can customize the display of the Artwork small, Artwork large, or Information mode.

1 Select the source

Press the [SRC] button. Turn the [Volume] knob and press it when the desired item is displayed.

↻ SRC Select mode 2: Pressing the [SRC] button repeatedly also switches source.

2 Enter Menu List mode

Press the [MENU] button.

3 Enter Display Setting mode and Select the Information Display

Turn the [Volume] knob and press it when the desired item is displayed.

Select "Settings" > "Display & Illumination"

> "Display Select" > "Type Select" > Artwork small, Artwork large, or Information.

4 Select the setting item to adjust

Turn the [Volume] knob and press it when the desired item is displayed.

Display	Setting
"Display Select"	
"Type Select"	Selects from Artwork small, Artwork large, or Information mode.
"Side Select" ^{*1}	Sets the icon display. Appear/ Disappear
"Text Select"	Sets the text display.
"Graphic Select" ^{*1}	Changes the wallpaper. Original/ User Wallpaper ^{*2}

^{*1} Only for Artwork small or Information mode.

^{*2} See <Wallpaper Downloading> (page 20).

5 Make a setting

Turn the [Volume] knob to select a setting value, and then press the [Volume] knob.

When selecting "Text Select":

1. Turn the [Volume] knob to select the text display part, and then press the [Volume] knob.

2. Turn the [Volume] knob to select the text, and then press the [Volume] knob.

6 Exit Menu List mode

Press the [MENU] button for at least 1 second, and then press it again briefly.

Text Display Selection

In FM Tuner source

Frequency & Program Service name ("Frequency/PS")	Radio text plus ^{*1} ("Radio Text Plus")
Song title ^{*1} ("Song Title")	Radio text ("Radio Text")
Artist name ^{*1} ("Artist Name")	Date ("Date")
Station name ^{*1} ("Station Name")	Spectrum analyzer ("Speana")
	Blank ("Blank")

^{*1} Information of Radio text plus is displayed.

In AM Tuner source

Frequency ("Frequency")	Spectrum analyzer ("Speana")
Date ("Date")	Blank ("Blank")

In USB/ iPod/ Internal Memory source

Song title ("Song Title")	My rate ("My rate") : iPod only
Artist name ("Artist Name")	Date ("Date")
Album name ("Album Name")	Spectrum analyzer ("Speana")
Folder name ("Folder Name")	Blank ("Blank")
File name ("File Name")	

In Auxiliary input source

Source name ("Source Name")	Spectrum analyzer ("Speana")
Date ("Date")	Blank ("Blank")

In Standby

Source name ("Source Name")	Blank ("Blank")
Date ("Date")	

In Bluetooth audio source (Optional : KIV-700 only)

Bluetooth audio ("Source Name")	Date ("Date")
Song title ^{*1} ("Song Title")	Spectrum analyzer ("Speana")
Artist name ^{*1} ("Artist Name")	Blank ("Blank")
Album name ^{*1} ("Album Name")	

^{*1} Only with KCA-BT300 (optional accessory) connected

In Disc changer source (Optional)

Source name ("Source Name")	Date ("Date")
Disc title ("Disc Title")	Spectrum analyzer ("Speana")
Track title ("Track Title")	Blank ("Blank")

In HD Radio source (Optional)

Frequency ("Frequency")	Artist name ^{*1} ("Artist Name")
Station name ("Station Name")	Date ("Date")
Song title ("Song Title"/"Title")	Spectrum analyzer ("Speana")
Album name ^{*1} ("Album Name")	Blank ("Blank")

^{*1} Only with KTC-HR300 (optional accessory) connected

In SIRIUS source (Optional)

Channel Name ("Channel Name")	Band & Channel Number ("Channel Number")
Song Title ("Song Title")	Date ("Date")
Artist name ("Artist Name")	Spectrum analyzer ("Speana")
Composer name ("Composer Name")	Blank ("Blank")
Category Name ("Category Name")	

In XM source (Optional)

Channel Name ("CHANNEL NAME")	Band & Channel Number ("CHANNEL NUMBER")
Song title ("SONG TITLE")	Date ("Date")
Artist name ("ARTIST NAME")	Spectrum analyzer ("Speana")
Category Name ("CATEGORY")	Blank ("Blank")



- If the selected display item does not have any information, alternative information is displayed.
- Some items cannot be selected depending on the display type and row.
- When selecting "Folder Name" while playing with iPod, names will be displayed depending on currently selected browsing items.
- If the iPod Control by Hand Mode is set to on while playing the iPod, "iPod By Hand Mode" is displayed.
- If all characters cannot be displayed while playing with iPod, the file number in the list is displayed.

Information	Display
Music title	"TITLE****"
Folder name	"FLD****"
File name	"FILE****"

Auxiliary Input Display Setting

Selecting the display when changing to Auxiliary input source.

1 Select the AUX source

Press the [SRC] button. Turn the [Volume] knob and press it when the desired item is displayed. Select the "AUX" display.

➡ SRC Select mode 2: Pressing the [SRC] button repeatedly also switches source.

2 Enter Menu List mode

Press the [MENU] button.

3 Enter Auxiliary input display setting mode

Turn the [Volume] knob and press it when the desired item is displayed. Select "Settings" > "Name Set".

4 Select the Auxiliary input display

Turn the [Volume] knob.

Select "AUX", "DVD", "PORTABLE", "GAME", "VIDEO", or "TV".

5 Exit Menu List mode

Press the [MENU] button for at least 1 second, and then press it again briefly.



- The Auxiliary input display can be set only when the built-in auxiliary input or the auxiliary input of optional KCA-S220A is used. On the KCA-S220A, "AUX EXT" is displayed by default.
- AUX source is initially set to "OFF". Before display setting, set "Built in AUX" described in <Initial Settings> (page 38) to "ON".

Clock and Other Functions

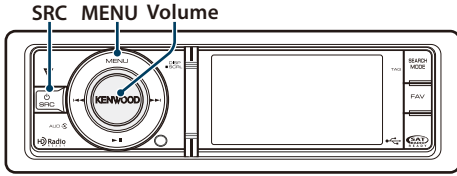

Clock and Date Adjustment

You can adjust the clock and date.

Display	Overview
"Settings"	
"Clock & Date"	
"Clock Adjust"*1	Sets the clock and Time zone.
"Time Synchronized"	Synchronizing the RDS station time data and this unit's clock. "ON" / "OFF"
"Summer Time"*1	Advances the clock one hour when set to ON. "ON" / "OFF"
"Sub Clock Adjust"	Adjusts the time difference caused by summer time. "-1h" / "0h" / "+1h"
"Date Adjust"	Sets the date.
"Date Mode"	Sets the date display mode.

(_ : Factory setting)

*1 The "Time Synchronized" is set to "OFF".

1 Enter Menu List mode

Press the [MENU] button.

2 Select RDS's automatic time adjustment

Turn the [Volume] knob and press it when the desired item is displayed.

Select "Settings" > "Clock & Date" > "Time Synchronized" > "ON" or "OFF".

When selected "OFF", proceed to step 3.

When selected "ON", proceed to step 6.

3 Enter Clock adjustment mode

Turn the [Volume] knob and press it when the desired item is displayed.

Select "Clock Adjust".

4 Adjusting Clock and Time zone

1. Turn the [Volume] knob and press it when the desired item is displayed.

Select hours, minutes or time zone (home or sub).

2. Turn the [Volume] knob to select a setting value, and then press the [Volume] knob.

3. Press the [MENU] button.

5 Select Summer Time

Turn the [Volume] knob and press it when the desired item is displayed.

Select "Summer Time" > "ON" or "OFF".

6 Enter Date adjustment mode

Turn the [Volume] knob and press it when the desired item is displayed.

Select "Date Adjust".

7 Adjusting Date

1. Turn the [Volume] knob and press it when the desired item is displayed.

Select month, day or year.

2. Turn the [Volume] knob to select a setting value, and then press the [Volume] knob.

3. Press the [MENU] button.

8 Enter Date format mode

Turn the [Volume] knob and press it when the desired item is displayed.

Select "Date Mode".

9 Select Date format

Turn the [Volume] knob and press it when the desired item is displayed.

Select from 7 types.

10 Exit Menu List mode

Press the [MENU] button for at least 1 second, and then press it again briefly.

Remarks

• Time zone

Set a time zone for your area as "Home". When you set a time zone for different area to the "Sub", clocks for two time zones can be displayed on the clock display. See <Customization of Clock Display> (page 35).

For time zone list, see <Time zone list> (page 72).

Initial Settings

You can select following Initial Setting items.

1 Select the Standby

Press the [SRC] button. Turn the [Volume] knob and press it when the desired item is displayed.

Select the "STANDBY" display.

➡ SRC Select mode 2: Pressing the [SRC] button repeatedly also switches source.

2 Enter Menu List mode

Press the [MENU] button.

3 Enter Initial Setting mode

Turn the [Volume] knob and press it when the desired item is displayed.

Select "Initial Settings".

4 Select the setting item to adjust

Turn the [Volume] knob and press it when the desired item is displayed.

Display	Overview
"Initial Settings"	
"Source Select"	Sets the source selection method. "1"/"2"
"Beep"	Setting the operation check sound (beep sound) ON/OFF. "ON"/"OFF"
"Menu Language Select"	You can select the display language for the Menu list item. "English"/"Français"/"Español"
"Built in AUX"	When this is set to ON, AUX source can be selected. "ON": Allows AUX source to be selected. Use this setting when the built-in AUX terminal is connected to the external equipment all the time. "OFF": Disable AUX source selection. Use this setting when the built-in AUX terminal is not used.
"Favorite Delete"	Deletes Favorite Preset Memory. Refer to <Favorite Preset Memory Delete> (page 49).
"Built in AMP"	Selecting "OFF" turns off the built-in amplifier. Turning off the built-in amplifier improves the quality of the sound from Preout. "ON"/"OFF"
"AV Out Set"	Changes the iPod setting from AV Output to output-only terminal. "ON"/"OFF"
"System F/W Update"	Updates the firmware. The update information will be posted on the following URL as necessary. www.kenwood.com/cs/ce/

(_ : Factory setting)

5 Make a setting

Turn the [Volume] knob to select a setting value, and then press the [Volume] knob.

6 Exit Menu List mode

Press the [MENU] button for at least 1 second, and then press it again briefly.

Demonstration Mode Setting

Turning the demonstration mode ON/OFF.

1 Enter Menu List mode

Press the [MENU] button.

2 Enter Demonstration mode setting

Turn the [Volume] knob and press it when the desired item is displayed.

Select "DEMO Mode".

3 Set the Demonstration mode

Turn the [Volume] knob and press it when the desired item is displayed.

Select "ON" or "OFF".

4 Exit Menu List mode

Press the [MENU] button for at least 1 second, and then press it again briefly.

Function of KIV-700

Muting Volume upon Reception of Phone Call

The audio system automatically mutes when a call comes in.

When a call comes in

"CALL" is displayed.

The audio system pauses.

Listening to the audio during a call

Press the [SRC] button.

The "CALL" display disappears and the audio system comes back ON.

When the call ends

Hang up the phone.

The "CALL" display disappears and the audio system comes back ON.



- To use the TEL Mute feature, you need to hook up the MUTE wire to your telephone using a commercial telephone accessory. Refer to <Connecting Wires to Terminals> (page 76).

Audio Adjustments

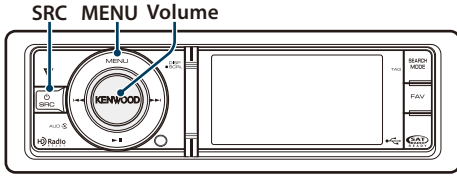

Audio Control

You can adjust following Audio Setting items.

Display	Overview
"Subwoofer Level"	You can set subwoofer level. "–15" — "0" — "+15"
"DSP Set"	"Bypass": Disables the DSP function. "Through": Enables the DSP function.
"Equalizer"	Sets the sound quality. - Preset Equalizer Curve Select (page 41). - Manual Equalizer Control (page 41).
"BassBoost"	Sets the Bass Boost level in two steps. "OFF"/"STEP1"/"2"
"HIGHWAY-SOUND"	Compensates the low volume or bass sound being lost by road noises to make vocal sound clearer. "OFF"/"STEP1"/"2"/"3"
"Supreme+"	Turns ON/OFF the Supreme plus function. Can be set while USB, iPod and Internal Memory source. "ON"/"OFF"
"Position"	Compensates the sound environment in accordance with the listening position. - Listening Position Selection (page 42). - Listening Position Fine Adjustments (page 42).
"Balance"	Adjusts left/right speaker balance. (Left) "L15" — "0" — "R15" (Right)
"Fader"	Adjusts front/rear speaker balance. (Rear) "R15" — "0" — "F15" (Front)
"2Zone Rear Volume"	Refer to <Dual Zone System> (page 43).
"Subwoofer"	Turns on/off the subwoofer output. "ON"/"OFF"
"Detailed Setup"	
"Car Type"	To get clear sound, set the sound environment according to the location and size of physically installed speakers with reference to the followings:
"Speaker Setting"	
"Car Type Adjust"	
"X'Over"	
"Volume Offset"	Sets each source's volume as a difference from the basic volume. "–8" — "0" (AUX: "–8" — "+8")

"2Zone Select"	Sets the Dual Zone System. - Dual Zone System (page 43).
"2Zone Front/Rear"	Sets the audio preset. - Audio Preset Recall (page 47). - Audio Preset Memory (page 46).

(_ : Factory setting)

1 Select the source

Press the [SRC] button. Turn the [Volume] knob and press it when the desired item is displayed.

Select a source other than "STANDBY".

➤ SRC Select mode 2: Pressing the [SRC] button repeatedly also switches source.

2 Enter Audio Control mode

Press the [Volume] knob.

3 Select the setting item to adjust

Turn the [Volume] knob and press it when the desired item is displayed.

4 Make a setting

Turn the [Volume] knob to select a setting value, and then press the [Volume] knob.

5 Exit Audio Control mode

Press the [MENU] button for at least 1 second.

Remarks

• DSP Set

When "DSP Set" is set to "Bypass", the DSP function is disabled, and the colored items cannot be set.

• HIGHWAY-SOUND

Increases the volume of faintest sound being lost by road noises to make the sound more audible. Additionally, it accentuates bass sound being lost by road noises to make the bass sound more dynamic.

- HIGHWAY-SOUND is not available in tuner source and HD Radio source.

• Supreme+ (Supreme Plus)

Technology to extrapolate and supplement with proprietary algorithm, the high-frequency range that is cut off when encoding. The bass and vocal sound that are cut off by encoding are supplemented for the reproduction of natural sound quality. Supplementing is optimized by compression format and processed according to bit rate. The effect is negligible with music that is encoded at high bit rate, variable bit rate or has minimal high frequency range.

• Dual Zone System

Main source and sub source output Front channel and Rear channel separately.

Preset Equalizer Curve Select

You can select following Equalizer curve.

Display	Equalizer curve
"Natural"	Natural
"User"	User*
"Rock"	Rock
"Pops"	Pops
"Easy"	Easy
"Top40"	Top 40
"Jazz"	Jazz
"Game"	Game
"iPod"	iPod (During iPod source only)

* The Equalizer curve set in the section <Manual Equalizer Control> is recalled.

1 Enter Audio Control mode

Press the [Volume] knob.

2 Enter Preset Equalizer mode

Turn the [Volume] knob and press it when the desired item is displayed.

Select "Equalizer" > "Preset Equalizer".

3 Select the Equalizer curve

Turn the [Volume] knob and press it when the desired item is displayed.

≠ Select the iPod Equalizer curve

You can select from 22 Equalizer curve types for iPod when "iPod" is selected.

1. Enter iPod Equalizer mode

Press the [Volume] knob.

2. Select the iPod Equalizer curve

Turn the [Volume] knob and press it when the desired item is displayed.

4 Exit Audio Control mode

Press the [MENU] button for at least 1 second.



• You can select for each source.

Manual Equalizer Control

You can adjust following Equalizer Control items.

Band	Item	Range
"BAND1" (62.5 Hz)	"GAIN" Band level "EFFECT" Bass Effect	-9 — +9 dB "ON" / "OFF"
"BAND2" (250 Hz)	"GAIN" Band level	-9 — +9 dB
"BAND3" (1 kHz)	"GAIN" Band level	-9 — +9 dB
"BAND4" (4 kHz)	"GAIN" Band level	-9 — +9 dB
"BAND5" (16 kHz)	"GAIN" Band level	-9 — +9 dB

1 Enter Audio Control mode

Press the [Volume] knob.

2 Enter Manual Equalizer Control mode

Turn the [Volume] knob and press it when the desired item is displayed.

Select "Equalizer" > "Manual Equalizer".

3 Select the setting item to adjust

Turn the [Volume] knob and press it when the desired item is displayed.

4 Make a setting

Turn the [Volume] knob to select a setting value, and then press the [Volume] knob.

5 Exit Audio Control mode

Press the [MENU] button for at least 1 second.



- When "iPod" is selected in the section <Preset Equalizer Curve Select> (page 41), Manual Equalizer Control is disabled.
- You can select for each source.

Audio Adjustments

Listening Position Selection

The sound environment can be compensated in accordance with the selected position. According to the listening position, select the position from the following settings.

Compensation seat	Display
Not compensating.	"ALL"
Front-Left seat	"FL"
Front-Right seat	"FR"
Front seat	"F ALL"

- 1 Enter Audio Control mode**
Press the [Volume] knob.
- 2 Enter Preset position setting mode**
Turn the [Volume] knob and press it when the desired item is displayed.
Select "Position" > "Preset Position".
- 3 Select the seat you want to compensate**
Turn the [Volume] knob to select a setting value, and then press the [Volume] knob.
- 4 Exit Audio Control mode**
Press the [MENU] button for at least 1 second.

Listening Position Fine Adjustments

Making fine adjustment of the value specified at Preset position selection per speaker.

- 1 Enter Audio Control mode**
Press the [Volume] knob.
- 2 Enter Manual position setting mode**
Turn the [Volume] knob and press it when the desired item is displayed.
Select "Position" > "DTA".
- 3 Select the setting item to adjust**
Turn the [Volume] knob and press it when the desired item is displayed.

Item	Setting overview
"Front" / "L"	Front Left speaker
"Front" / "R"	Front Right speaker
"Rear" / "L"	Rear Left speaker
"Rear" / "R"	Rear Right speaker
"SW" / "L"	Subwoofer Left
"SW" / "R"	Subwoofer Right
"INITIAL"	Initialize the setting values.

- 4 Make a setting**
Turn the [Volume] knob to select a setting value, and then press the [Volume] knob.
Adjust between 0 and 5.58 feet.
Press the [Volume] knob for at least 1 second if you want to execute the "INITIAL".
- 5 Exit Audio Control mode**
Press the [MENU] button for at least 1 second.

Dual Zone System

The separate sources can be selected for Front channel and Rear channel.

Display	Overview
"2Zone Rear Volume"*1	Adjust the volume of Rear channel. "0" — "35"
"Detailed Setup"	
"2Zone Select"	The Dual Zone System is enabled by selecting a sub source. "OFF"/"USB" ("iPod"/"Zune")/"INT MEM"/"AUX"
"2Zone Front/Rear"*1	Specifies the destination of sub source sound when the Dual Zone function is turned on. "Rear"/"Front"

(__ : Factory setting)

*1 The Dual Zone System is enabled.

1 Select the source

Press the [SRC] button. Turn the [Volume] knob and press it when the desired item is displayed.

Select a source other than "STANDBY".

🔊 SRC Select mode 2: Pressing the [SRC] button repeatedly also switches source.

2 Enter Audio Control mode

Press the [Volume] knob.

3 Turn the [Volume] knob and press it when the desired item is displayed.

Select "Detailed Setup".

4 Select the setting item to adjust

Turn the [Volume] knob and press it when the desired item is displayed.

5 Make a setting

Turn the [Volume] knob to select a setting value, and then press the [Volume] knob.

6 Exit Audio Control mode

Press the [MENU] button for at least 1 second.



- Select Main source by [SRC] button.
- Adjust the volume of Front channel by [Volume] knob.
- The Audio Control has no effect on sub source.
- "USB", "iPod" and "Int.Mem." (Internal memory) cannot be set at the same time for the main and sub sources.
- There are following limitations when Dual Zone System is enabled.
 - There is no output from the subwoofer.
 - "Fader", "Subwoofer Level" of <Audio Control> (page 40) and DSP function are not available.
- The Bluetooth audio source can be set exclusively to the front speaker. Set "2Zone Front/Rear" to "Rear".

- The source set as a sub source cannot be operated during the dual zone mode. Cancel the mode and then operate the source.

DSP Setup

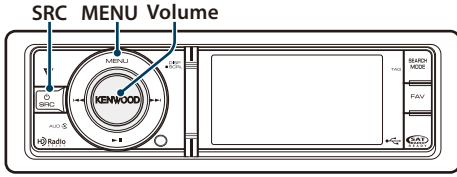

Car Type Selection

You can compensate the delay of the sound arrival time by selecting your environment from the following car types.

Display	Overview
"Off"	Not compensating.
"Compact"	Compact car
"FullSize Car"	Full size car
"Wagon"	Station wagon
"Minivan"	Minivan
"SUV"	Sport-utility vehicle
"Minivan (Long)"	Long Minivan

1 Enter Audio Control mode

Press the [Volume] knob.

2 Enter Car Type select mode

Turn the [Volume] knob and press it when the desired item is displayed.
Select "Detailed Setup" > "Car Type".

3 Select the car type

Turn the [Volume] knob and press it when the desired item is displayed.

4 Exit Audio Control mode

Press the [MENU] button for at least 1 second.



- You can compensate the distances in more details by using <Car Type Fine Adjustments> (page 45) function.

Speaker Setting

The speaker X'Over is automatically set when the position and size of each speaker are selected from the following items.

Speaker	Item	Range
"FRONT"	"Location"	Speaker Location Front "Door", "On Dash", "Under Dash"
	"Size"	Speaker Size Front "O.E.M.", "4inch", "5inch", "6 1/2inch", "6 3/4inch", "7inch", "4x6", "5x7", "6x8", "6x9", "7x10"
	"Tweeter"	Speaker Size Tweeter "None", "Use"
"REAR"	"Location"	Speaker Location Rear • "Door", "Rear Deck" • "2nd Row", "3rd Row" (Car Type: "Minivan", "Minivan (Long)")
	"Size"	Speaker Size Rear "None", "O.E.M.", "4inch", "5inch", "6 1/2inch", "6 3/4inch", "7inch", "4x6", "5x7", "6x8", "6x9", "7x10"
"SUB W"	"Size"	Speaker Size Subwoofer "None", "6 1/2inch", "8inch", "10inch", "12inch", "15inch Over"

1 Enter Audio Control mode

Press the [Volume] knob.

2 Enter Speaker setting mode

Turn the [Volume] knob and press it when the desired item is displayed.
Select "Detailed Setup" > "Speaker Setting".

3 Select the setting item to adjust

Turn the [Volume] knob and press it when the desired item is displayed.

4 Make a setting

Turn the [Volume] knob to select a setting value, and then press the [Volume] knob.

5 Exit Audio Control mode

Press the [MENU] button for at least 1 second.

Car Type Fine Adjustments

Adjusting fine tuning of the speaker position compensation value specified at <Car Type Selection> (page 44).

Display	Item	Range
"Front"	Front speaker	0 – 14.44 feet
"Rear"	Rear speaker	0 – 14.44 feet
"SW"	Subwoofer	0 – 14.44 feet

1 Enter Audio Control mode

Press the [Volume] knob.

2 Enter Car Type Adjustment mode

Turn the [Volume] knob and press it when the desired item is displayed.

Select "Detailed Setup" > "Car Type Adjust".

3 Select the setting item to adjust

Turn the [Volume] knob and press it when the desired item is displayed.

4 Make a setting

Turn the [Volume] knob to select a setting value, and then press the [Volume] knob.

The settings of the delay time are automatically identified and compensated by specifying the distances of each speaker from the center of the vehicle interior.

- 1 Set the front and rear positions and the height of the reference point to the position of the ears of the person sitting in the front seat, and set the right and left positions to the center of the vehicle interior.
- 2 Measure the distances from the reference point to the speakers.
- 3 Calculate the distance difference in accordance with the farthest speaker.

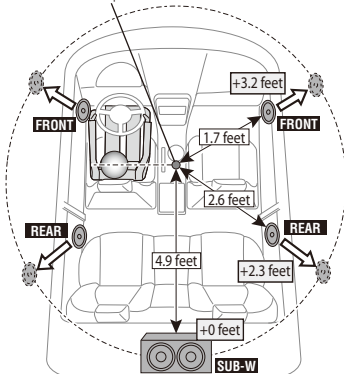

5 Exit Audio Control mode

Press the [MENU] button for at least 1 second.

DSP Setup

X'Over Setting

Fine adjusting the following setting values corresponding to the X'Over values set in the section <Speaker Setting> (page 44).

Display	Item	Range
"X'Over"		
"Front"	"FC"	Front High Pass Filter Through, 30, 40, 50, 60, 70, 80, 90, 100, 120, 150, 180, 220, 250 (Hz)
	"SLOPE"	Front High Pass Slope -6, -12, -18, -24 dB/Oct
"Rear"	"FC"	Rear High Pass Filter Through, 30, 40, 50, 60, 70, 80, 90, 100, 120, 150, 180, 220, 250 (Hz)
	"SLOPE"	Rear High Pass Slope -6, -12, -18, -24 dB/Oct
"Subwoofer"	"FC"	Subwoofer Low Pass Filter 30, 40, 50, 60, 70, 80, 90, 100, 120, 150, 180, 220, 250, Through (Hz)
	"SLOPE"	Subwoofer Slope -6, -12, -18, -24 dB/Oct
	"PHASE"	Subwoofer Phase Reverse (180°)/ Normal (0°)

- 1 Enter Audio Control mode**
Press the [Volume] knob.
- 2 Enter X'Over setting mode**
Turn the [Volume] knob and press it when the desired item is displayed.
Select "Detailed Setup" > "X'Over".
- 3 Select the speaker you want to set**
Turn the [Volume] knob and press it when the desired item is displayed.
Select "Front", "Rear", or "Subwoofer".
- 4 Select the setting item to adjust**
Turn the [Volume] knob and press it when the desired item is displayed.
- 5 Make a setting**
Turn the [Volume] knob to select a setting value, and then press the [Volume] knob.
- 6 Repeat steps 3 to 5 to complete the X'Over settings**
- 7 Exit Audio Control mode**
Press the [MENU] button for at least 1 second.

Audio Preset Memory

Registering the value setup by Sound Control.

1 Setup Sound Control

Refer to the following operations to setup the Sound Control.

- Car Type Selection (page 44)
- Speaker Setting (page 44)
- Car Type Fine Adjustments (page 45)
- X'Over Setting (page 46)
- Manual Equalizer Control (page 41)
- Listening Position Selection (page 42)
- Listening Position Fine Adjustments (page 42)

2 Enter Audio preset memory mode

Turn the [Volume] knob and press it when the desired item is displayed.

Select "Detailed Setup" > "Preset" > "Preset Memory".

3 Select the number to put in the memory

Turn the [Volume] knob and press it when the desired item is displayed.

Select a preset number.

4 Turn the [Volume] knob and press it when the desired item is displayed.

Select "YES".

"Completed" is displayed.

5 Exit Audio Control mode

Press the [MENU] button for at least 1 second.



- Register 6 patterns of Audio Preset Memory.
- Preset number "1":
When you press the Reset, all the sources will be the setting value which is registered.
- Preset number "1" and "2":
The memory cannot be erased by the Reset button.
- This function cannot be registered when the iPod Equalizer set in <Preset Equalizer Curve Select> (page 41).

Audio Preset Recall

Recalling the sound setup registered by <Audio Preset Memory> (page 46).

1 Select the source

Press the [SRC] button. Turn the [Volume] knob and press it when the desired item is displayed.

⚠ SRC Select mode 2: Pressing the [SRC] button repeatedly also switches source.

2 Enter Audio preset recall mode

Turn the [Volume] knob and press it when the desired item is displayed.

Select "Detailed Setup" > "Preset" > "Preset Recall".

3 Select the number to recall in the memory

Turn the [Volume] knob and press it when the desired item is displayed.

Select the preset number.

4 Turn the [Volume] knob and press it when the desired item is displayed.

Select "YES".

"Completed" is displayed.

5 Exit Audio Control mode

Press the [MENU] button for at least 1 second.



- The "User" of <Preset Equalizer Curve Select> (page 41) is changed to the value which was recalled.
- The Equalizer curve is changed to the value which was recalled by the selected source.

Favorite Control

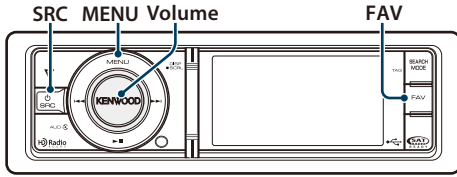

Favorite Preset Memory

Registering the operation procedure to select your favorite broadcast station or iPod Playlists/ Artists, etc.

1 Display a favorite item

Source	Registerable items
TUNER/SIRIUS/XM/HD	Frequency or channel
iPod	Browse item such as Playlists/ Artists/ Albums, etc.
Menu list Setting	Menu list Setting item
Audio control	Audio control item
Hands-free phone	Telephone number retrieval.

"[FAV]" is displayed when the operation procedure can be registered.

iPod setting

The desired list in the first hierarchy can be registered.

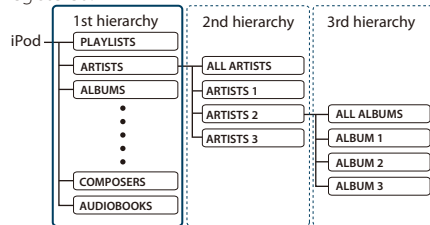

2 Enter Favorite Preset Memory mode

Press the [FAV] button for at least 1 second.

3 Select the number to put in the memory

Turn the [Volume] knob.

4 Put the Favorite Preset in the memory

Press the [Volume] knob.

Canceling the Favorite Preset Memory mode

Press the [FAV] button.



- Registering the operation procedure to an existing preset number overwrites the existing procedure.
- Register 6 of Favorite Preset Memory.
The memory cannot be erased by the Reset button.

- If the contents in iPod are changed after the FAVORITE registration, the list registered in this unit becomes different from that in iPod. In this case, perform the FAVORITE registration again.

Favorite Preset Recall

Retrieving an item registered to Favorite.

1 Enter Favorite Preset Recall mode

Press the [FAV] button.

2 Select the number to recall in the Favorite memory

Turn the [Volume] knob and press it when the desired item is displayed.

Select the preset number.

Canceling the Favorite Preset Recall mode

Press the [FAV] button.



- When iPod is selected for the source, the list selection screen for Playlists/ Artists/ Albums, etc. is displayed. Songs will not be automatically played.
- When connecting an iPod via USB hub, Favorite preset can be recalled only during the playback of the iPod.

Favorite Preset Memory Delete

Deleting an item registered to Favorite.

1 Select the Standby

Press the [SRC] button. Turn the [Volume] knob and press it when the desired item is displayed.

Select the "STANDBY" display.

⚡ SRC Select mode 2: Pressing the [SRC] button repeatedly also switches source.

2 Enter Menu List mode

Press the [MENU] button.

3 Enter Favorite Preset Memory Delete mode

Turn the [Volume] knob and press it when the desired item is displayed.

Select "Initial Settings" > "Favorite Delete".

4 Select the number you want to delete

Turn the [Volume] knob and press it when the desired item is displayed.

Select the preset number.

Select "ALL" if you want to delete all.

5 Turn the [Volume] knob and press it when the desired item is displayed.

Select "YES".

"Completed" is displayed.

Exit Favorite Preset Memory Delete mode.

Press the [MENU] button for at least 1 second, and then press it again briefly.

Bluetooth Setup

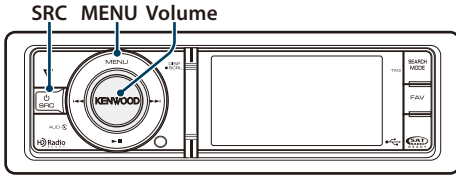

Bluetooth Setting

You can select following Bluetooth Setting items.

1 Enter Bluetooth mode

KIV-BT900: Press the [**MENU**] button.

KIV-700: Press the [**PLAY MODE**] button for at least 1 second.

2 Turn the [Volume] knob and press it when the desired item is displayed.

Select "BT Settings".

3 Select the setting item to adjust

Turn the [Volume] knob and press it when the desired item is displayed.

Display	Overview
"SMS Inbox"	Display the received short message. Refer to <Display the SMS> (page 56).
"BT Settings"	
"Phone Selection"	Select a cell-phone or Bluetooth audio player connection.
"Audio Selection"* ¹	Refer to <Selecting the Bluetooth Device You Wish to Connect> (page 52).
"SMS Download"	Download a short message. Refer to <Downloading the SMS> (page 56).
"Voice Tag"	Registers voice for voice recognition and voice to select the Phone number category in Phone book. - Adding a Voice Dialing Command (page 54) - Setting a Voice Command for Category (page 55)
"Detailed Setup"	Move to detailed item.
"Device Registration"	Register a Bluetooth device (pairing). Refer to <Registering Bluetooth Device> (page 51).
"Special Device Select"	
"Device Delete"	Cancel registration of the Bluetooth device. Refer to <Deleting a Registered Bluetooth Device> (page 53).
"PIN Code Edit"	Specify the PIN code required when registering this unit using the Bluetooth device. Refer to <Registering PIN Code> (page 52).
"Auto Answer"	Answer a call automatically after lapse of the preset time interval for automatic answer. "OFF"/"0s" – "8s" – "99s"

"Bluetooth HF"/ "Bluetooth HF/ Audio"* ¹	You can specify output speakers for hands-free voice communication and Bluetooth audio sound. "Front": Outputs voice from the front speakers. "All": Outputs voice from the front and rear speakers.
"Call Beep"	You can output a beep from the speaker when a call comes in. "ON": Beep is heard. "OFF": Beep is canceled.
"BT F/W Update"	Display the version of the firmware of this unit.
"Mic Gain"* ²	Adjust the sensitivity of the microphone for a telephone call. Adjust the voice of caller. Setting to "+" increases the voice volume. "-3" – "0" – "+3"
"Noise Reduction"* ²	Reduce the noises generated by surrounding environment without changing the microphone volume. Adjust the voice of caller when it is not clear. Setting to "+" increases the noise reduction. "-3" – "0" – "+3"
"Echo Cancel Level"* ²	Adjust the level of echo cancellation. Setting to "+" increases the echo cancel reduction. "-2" – "0" – "+2"

(_ : Factory setting)

*¹ Function of KIV-700 with KCA-BT300/BT200 (Optional Accessory)

*² Function of KIV-BT900/ KIV-700 with KCA-BT300 (Optional Accessory)

4 Make a setting

Turn the [Volume] knob to select a setting value, and then press the [Volume] knob.

5 Exit BT Setting mode

Press the [MENU] button for at least 1 second.

Remarks

• "Auto Answer" (Setting the Time Interval for Automatic Answer)

This function automatically answers (responds to) a call after lapse of the preset time interval for automatic answer.
"OFF": Does not answer the phone call automatically.
"0": Automatically answers the phone call at once.
"1s" – "99s": Automatically answers the phone call after lapse of 1 – 99 seconds.



- If the time set in the cell-phone is shorter than that set in the unit, the former will be used.
- This function does not work for call waiting.

• "BT F/W Update" (Displaying the Firmware Version)

Display the version of the firmware of this unit.

For how to update the firmware, access our web site.

<http://www.kenwood.com/cs/ce/bt/>

Registering Bluetooth Device

To make your Bluetooth device (cell-phone) usable with this unit, you need to register it (pairing). You can register up to 5 Bluetooth devices to this unit.

Registering from this unit

1 Enter Bluetooth mode

KIV-BT900: Press the [] button.

KIV-700: Press the [PLAY MODE] button for at least 1 second.

2 Enter Bluetooth device registration mode

Turn the [Volume] knob and press it when the desired item is displayed.

Select "BT Settings" > "Detailed Setup" > "Device Registration".

Search for the Bluetooth device.

When search is completed, "Finished" is displayed.

3 Select a Bluetooth device

Turn the [Volume] knob and press it when the desired item is displayed.

4 "Pairing" is displayed (KCA-BT300 only)

If "Pairing Success" is displayed, proceed to step 7.

If "PIN Code NG" is displayed, proceed to steps 5.

5 Input the PIN code

1. Turn the [Volume] knob and press it when the desired item is displayed.
Select the digit.

2. Turn the [Volume] knob to select the numbers, and then press the [Volume] knob.

6 Transmit the PIN code

Press the [Volume] knob for at least 1 second.

If "Pairing Success" is displayed, registration is completed.

 If the error message appears even though the PIN code is correct, try <Registering Special Bluetooth device>.

7 Return to the device list

Press the [Volume] knob.

8 Exit BT Setting mode

Press the [MENU] button for at least 1 second.



- This unit allows up to eight digits to be input for a PIN code. If a PIN code cannot be input from this unit, it can be input from the Bluetooth device.
- If there are 5 or more Bluetooth devices registered, you cannot register a new Bluetooth device.

Registering Special Bluetooth device

Allow registration of a special device that cannot be registered normally (pairing).

1. Select Special device registration mode

Turn the [Volume] knob and press it when the desired item is displayed.

Select "BT Settings" > "Detailed Setup" > "Special Device Select".

A list is displayed.

2. Select a device name

Turn the [Volume] knob and push the center when the desired device name is displayed.

If "Completed" is displayed, registration is completed.

3. Go through the procedure step 3 of

<Registering from this unit> and complete the registration (pairing).

Canceling Special device registration mode

Press the [MENU] button for at least 1 second.



- If the device name is not in the list, select "Other Phones".

Bluetooth Setup

Registering PIN Code

By operating the Bluetooth device, specify the PIN code necessary for registering this unit.

1 Enter Bluetooth mode

KIV-BT900: Press the [] button.

KIV-700: Press the [PLAY MODE] button for at least 1 second.

2 Enter PIN code edit mode

Turn the [Volume] knob and press it when the desired item is displayed.

Select "BT Settings" > "Detailed Setup" > "PIN Code Edit".

The current setting of PIN code is displayed.

3 Input the PIN code

1. Turn the [Volume] knob and press it when the desired item is displayed.

Select the digit.

2. Turn the [Volume] knob to select the numbers, and then press the [Volume] knob.

4 Register a PIN code

Press the [Volume] knob for at least 1 second.

If "Completed" is displayed, registration is completed.

5 Exit BT Setting mode

Press the [MENU] button for at least 1 second.



- By default, "0000" is specified.
- A PIN code can be specified with up to eight digits.

Selecting the Bluetooth Device You Wish to Connect

When two or more Bluetooth devices have already been registered, you need to select the Bluetooth device you wish to use.

1 Enter Bluetooth mode

KIV-BT900: Press the [] button.

KIV-700: Press the [PLAY MODE] button for at least 1 second.

2 Select Bluetooth device selection mode

Turn the [Volume] knob and press it when the desired item is displayed.

Cell-phone

Select "BT Settings" > "Phone Selection".

Audio player (KIV-700 only)

Select "BT Settings" > "Audio Selection".

"(name)" is displayed.

3 Select the Bluetooth device

Turn the [Volume] knob.

4 Set up the Bluetooth device

Press the [Volume] knob.

" (name)" or " (name)" is displayed.

" (blue): The selected Bluetooth device is busy.

" (gray): The selected Bluetooth device is on standby.

" " (blank): The Bluetooth device is deselected.

5 Exit BT Setting mode

Press the [MENU] button for at least 1 second.



- If a Bluetooth device is already selected, deselect it, and then select a different one.
- If you cannot select a device using the audio player, connect the device with the audio player.

Deleting a Registered Bluetooth Device

You can delete a registered Bluetooth device.

1 Enter Bluetooth mode

KIV-BT900: Press the [] button.

KIV-700: Press the [PLAY MODE] button for at least 1 second.

2 Enter Bluetooth device deletion mode

Turn the [Volume] knob and press it when the desired item is displayed.

Select "BT Settings" > "Detailed Setup" > "Device Delete".

"(name)" is displayed.

3 Select the Bluetooth device

Turn the [Volume] knob.

4 Delete the selected Bluetooth device

Press the [Volume] knob.

5 Turn the [Volume] knob and press it when the desired item is displayed.

Select "YES".

"Delete" is displayed.

6 Exit BT Setting mode

Press the [MENU] button for at least 1 second.



- When a registered cell-phone is deleted, its Phone Book, log, SMS, and voice tag are also deleted.

Downloading the Phone Book

Download the phone book data from the cell-phone to this unit so that you can use the Phone Book of this unit.

To download automatically

If the cell-phone supports a phone book synchronization function, the phone book is downloaded automatically after Bluetooth connection.



- Setting on the cell-phone may be required.
- If no phone book data is found in the unit even after the complete display, your cell-phone may not support automatic download of phone book data. In this case, try downloading manually.

To download from the cell-phone manually

1 By operating the cell-phone, end the hands-free connection.

2 By operating the cell-phone, send the phone book data to this unit

By operating the cell-phone, download the phone book data to this unit.

- During downloading:
"Downloading" is displayed.
- After completion of downloading:
"Completed" is displayed.

3 By operating the cell-phone, start the hands-free connection.

To clear the downloading completion message

Press any button.



- Up to 1000 phone numbers can be registered for each registered cell-phone.
- Up to 25 (KIV-BT900)/ 32 (KIV-700) digits can be registered for each phone number along with up to 50* characters representing a name.
(* 50: Number of alphabetical characters. Fewer characters can be input depending on the type of characters.)
- To cancel downloading of the phone book data, operate the cell-phone.

Bluetooth Setup

Adding a Voice Dialing Command

Add a voice tag to the phone book for voice dialing. You can register up to 35 voice tags.

1 Enter Bluetooth mode

KIV-BT900: Press the [] button.

KIV-700: Press the [PLAY MODE] button for at least 1 second.

2 Enter Phone book name edit mode

Turn the [Volume] knob and press it when the desired item is displayed.

Select "BT Settings" > "Voice Tag" > "Phonebook Name Edit".

3 Search for the name to register

Select the name to register with reference to 4 in <Calling a Number in the Phone Book> (page 32).

If a voice tag has already been registered for a name, "*" is displayed before the name.

4 Select a mode

Turn the [Volume] knob.

Display	Operation
"Phonebook Name Registration"	Register a voice tag.
"Phonebook Name Check"*	Play a voice tag.
"Phonebook Name Delete"*	Delete a voice tag.

* Displayed only when a name for which a voice tag has been registered is selected.

Select "Phonebook Name Registration" (Registration)

5 Register a voice tag (first)

"Enter Voice 1" is displayed.

When a beep is heard, say a voice tag within 2 seconds.

6 Confirm the voice tag (second)

"Enter Voice 2" is displayed.

When a beep is heard, say the same voice tag as that you said in step 6 within 2 seconds.

"Completed" is displayed.

7 End registration

Press the [Volume] knob.

Return to step 3. You can register another voice tag continuously.



- If your voice cannot be recognized, a message is displayed. Pressing the [Volume] knob allows you to retry voice input. Refer to <Troubleshooting Guide> (page 80).

Select "Phonebook Name Check" (Play)

5 Press the [Volume] knob.

Play the registered voice and return to step 3.

Select "Phonebook Name Delete" (Delete)

5 Delete a voice tag

Press the [Volume] knob.

6 Turn the [Volume] knob to select "YES", and then press the [Volume] knob.

Exit BT Setting mode

Press the [MENU] button for at least 1 second.



- Audio sound is not output during voice tag registration.

Setting a Voice Command for Category

Add a voice tag to the phone number category (type) for voice calling.

1 Enter Bluetooth mode

KIV-BT900: Press the [] button.

KIV-700: Press the [PLAY MODE] button for at least 1 second.

2 Enter Phone Number type edit mode

Turn the [Volume] knob and press it when the desired item is displayed.

Select "BT Settings" > "Voice Tag" > "Phonebook Type Edit".

3 Select the category (type) you wish to set

Turn the [Volume] knob and press it when the desired item is displayed.

Select "General", "Home", "Office", "Mobile", or "Other".

4 Select a mode

Turn the [Volume] knob.

Display	Operation
"Phonebook Type Registration"	Register a voice tag.
"Phonebook Type Check"*	Play a voice tag.
"Phonebook Type Delete"*	Delete a voice tag.

* Displayed only when a name for which a voice tag has been registered is selected. Function of KIV-700 with KCA-BT300/BT200 (Optional Accessory)

5 Register the category (type) by performing steps 5 to 7 in <Adding a Voice Dialing Command> (page 54).

6 Exit BT Setting mode

Press the [MENU] button for at least 1 second.



- Set the voice tag for all the 5 categories. If the voice tag is not registered for all the categories, the Phone book may not be recalled by voice command.

SMS (Short Message Service)

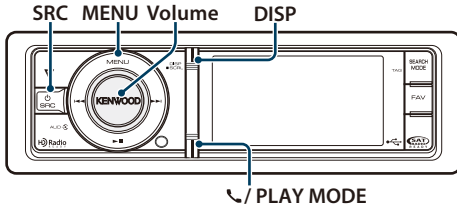

Downloading the SMS

Download the short message (SMS) arrived at the cell-phone so that it can be read on this unit.

1 Enter Bluetooth mode

KIV-BT900: Press the [] button.

KIV-700: Press the [PLAY MODE] button for at least 1 second.

2 Enter SMS download mode

Turn the [Volume] knob and press it when the desired item is displayed.

Select "BT Settings" > "SMS Download".

3 Start downloading

Press the [Volume] knob.

"SMS Downloading" is displayed.

When the downloading finishes, "Completed" is displayed.

4 Exit BT Setting mode

Press the [MENU] button for at least 1 second.



- The cell-phone must be able to transmit the SMS using Bluetooth. Setting on the cell-phone may be required. If the cell-phone does not support SMS function, the SMS download item in Function Control mode is not displayed.
- When the SMS is downloaded from the cell-phone, the unopened messages in the cell-phone are opened.
- The already-read and unread short messages can be respectively downloaded up to 75.

Display the SMS

The SMS arrived at the cell-phone is displayed on the receiver.

A newly arrived message is displayed.



- To prevent car accidents, the driver should not read the SMS while driving.

When a new message arrives

"SMS RECEIVED" is displayed.

The display disappears with any operations.

Displaying the SMS

1 Enter Bluetooth mode

KIV-BT900: Press the [] button.

KIV-700: Press the [PLAY MODE] button for at least 1 second.

2 Enter SMS Inbox mode

Turn the [Volume] knob and press it when the desired item is displayed.

Select "SMS Inbox".

A message list appears.

3 Select a message

Turn the [Volume] knob.

Each pressing of the [DISP] button switches between telephone number or name and message reception date.

4 Display the text

Press the [Volume] knob.

Turning the [Volume] knob scrolls the message. Pressing the [Volume] knob again returns to the message list screen.

5 Exit SMS Inbox mode

Press the [MENU] button.

6 Exit BT Setting mode

Press the [MENU] button for at least 1 second.



- The unopened message is displayed at the beginning of the list. Other messages are displayed in the order of reception.
- The SMS that has arrived when the cell-phone is not linked with Bluetooth cannot be displayed. Download the SMS.
- The short message cannot be displayed during downloading the SMS.

Satellite Radio Tuner Control (Optional)

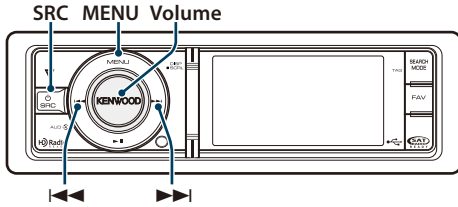

Basic Operation

Selecting Satellite Radio source

Press the [SRC] button. Turn the [Volume] knob and press it when the desired item is displayed.

Select the "SIRIUS", or "XM Radio" display.

⚙️ SRC Select mode 2: Pressing the [SRC] button repeatedly also switches source.



- You need to register to the service provider to receive the service by Satellite Radio. Consult the service provider if "CALL ... TO SUBSCRIBE" appears.
- The radio may take a little time to start receiving after you select the Satellite Radio source.
- If the signal reception fails, "Acquiring Signal"/"No Signal" appears.

Selecting the channel

Press the [◀◀] or [▶▶] button.

Selecting the Preset Band

1. Enter Menu List mode
Press the [MENU] button.
2. Turn the [Volume] knob and press it when the desired item is displayed.
Select "SR1", "SR2", "SR3" or "SR4". (SIRIUS)
Select "XM1", "XM2", "XM3" or "XM4". (XM)

Switching display

Press the [DISP] button to select display mode.

Selects the Information or Clock.

Display example of information display mode

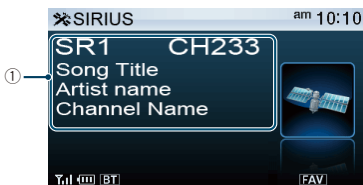

- ① Station information (see <Customization of Display> (page 36))

Satellite Radio Setting

You can select following Satellite Radio Setting items.

- 1 Select Satellite Radio source
- 2 Enter Menu List mode
Press the [MENU] button.
- 3 Turn the [Volume] knob and press it when the desired item is displayed.
Select "Settings".
- 4 Select the setting item to adjust
Turn the [Volume] knob and press it when the desired item is displayed.

Display	Selectable setting/item
"Settings"	
"Seek Mode"	Selects the tuning mode of the radio. "Channel": Normal manual seeking control. "Preset": Search in order of the channels in the Preset memory
"ESN"	Displays the Electronic Serial Number of satellite radio. "ESN="

(_ : Factory setting)

5 Make a setting

Turn the [Volume] knob to select a setting value, and then press the [Volume] knob.

6 Exit Menu List mode

Press the [MENU] button for at least 1 second, and then press it again briefly.

Category and Channel Search

Selecting the channel and category you want to receive.

- 1 Select Satellite Radio source
- 2 Enter Menu List mode
Press the [MENU] button.
- 3 Enter Category and Channel Search mode
Turn the [Volume] knob and press it when the desired item is displayed.
Select "Channel Search".
- 4 Select the Category
Turn the [Volume] knob to select Category, and then press the [Volume] knob.
- 5 Select the Channel
Turn the [Volume] knob to select Channel, and then press the [Volume] knob.

Canceling Category and Channel Search mode

Press the [MENU] button for at least 1 second, and then press it again briefly.



- You cannot Channel search until the category information is acquired.

Preset Memory

Putting the channel in the memory.

- 1 Select the channel you wish to store in the preset memory**
- 2 Enter Menu List mode**
Press the [MENU] button.
- 3 Enter Preset Memory mode**
Turn the [Volume] knob and press it when the desired item is displayed.
Select "List & Memory".
- 4 Select the number to put in the memory**
Turn the [Volume] knob and press it for at least 2 seconds when the desired item is displayed.
Select the preset number.



- Only the channel number is stored. Category information is not stored.

Preset Tuning

Recalling the channels in the memory.

- 1 Select Satellite Radio source**
- 2 Enter Menu List mode**
Press the [MENU] button.
- 3 Select a desired station in the memory**
Turn the [Volume] knob and press it when the desired item is displayed.
Select "List & Memory" > Preset number.

Channel Scan

Every receivable Channel is checked for 10 seconds.

- 1 Select Satellite Radio source**
- 2 Enter Menu List mode**
Press the [MENU] button.
- 3 Start Channel Scan**
Turn the [Volume] knob and press it when the desired item is displayed.
Select "Channel Scan".
- 4 Release it when the channel you want to listen to is received**
Press the [Volume] knob.

Function of remote control

Direct Access Tuning

Entering the channel and tuning.

- 1 Select Satellite Radio source**
- 2 Enter Direct Access Tuning mode**
Press the [DIRECT] button on the remote control.
- 3 Enter the channel**
Press the number buttons.
- 4 Tune in to the entered channel**
Press the [◀◀] or [▶▶] button.

Canceling Direct Access Tuning

Press the [DIRECT] button on the remote control.



- If you make no button operation for 10 seconds, the Direct Access Tuning mode is automatically canceled.
- If you cannot receive any signal in the input Channel due to bad conditions on radio wave or other such problems, "Acquiring Signal"/"No Signal" appears.

HD Radio™ Tuner Control (Optional)

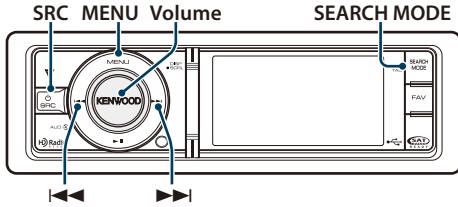

Basic Operation

Selecting HD Radio source

Press the [SRC] button. Turn the [Volume] knob and press it when the desired item is displayed.

Select the "HD RADIO" display.

⚡ SRC Select mode 2: Pressing the [SRC] button repeatedly also switches the source.

Selecting the Receiving Band

1. Enter Menu List mode
Press the [MENU] button.
2. Turn the [Volume] knob and press it when the desired item is displayed.
Select "FM1", "FM2", "FM3" or "AM".

Selecting the Receiving station

Press the [◀◀] or [▶▶] button.

During reception of stereo stations the "ST" indicator lights up.

⚡ Details of the station selecting in operation are set in the "Seek Mode" of [<HD Radio™ Setting>](#) (page 61).

Switching display

Press the [DISP] button to select display mode.
Selects the Information or Clock.

Display example of information display mode



- ① Station information (see [<Customization of Display>](#) (page 36))
- ② Status indicator (see [<Display Indicator items>](#) (page 71))

Station Preset Memory

Putting a station in the memory.

- 1 Select the radio band and tune in a desired radio station you wish to store in the preset memory
- 2 Enter Menu List mode
Press the [MENU] button.
- 3 Enter Preset Memory mode
Turn the [Volume] knob and press it when the desired item is displayed.
Select "List & Memory".
- 4 Select the number to put in the memory
Turn the [Volume] knob and press it for at least 2 seconds when the desired item is displayed.
Select the preset number.

Auto Memory Entry

Putting stations with good reception in the memory automatically.

- 1 Select the radio band you wish to store in the preset memory
- 2 Enter Menu List mode
Press the [MENU] button.
- 3 Enter Auto Memory Entry mode
Turn the [Volume] knob and press it when the desired item is displayed.
Select "Settings" > "Auto Memory".
- 4 Open Auto Memory Entry
Turn the [Volume] knob and press it when the desired item is displayed.
Select "YES".

When 6 stations that can be received are put in the memory, auto memory entry closes.

Preset Tuning

Recalling the stations in the memory.

- 1 Select the radio band**
- 2 Enter Menu List mode**
Press the [MENU] button.
- 3 Select a desired station in the memory**
Turn the [Volume] knob and press it when the desired item is displayed.
Select "List & Memory" > Preset number.

HD Radio™ Setting

You can select following HD Radio Setting items.

- 1 Select the HD Radio source**
- 2 Enter Menu List mode**
Press the [MENU] button.
- 3 Turn the [Volume] knob and press it when the desired item is displayed.**
Select "Settings".
- 4 Select the setting item to adjust**
Turn the [Volume] knob and press it when the desired item is displayed.

Display	Overview
"Settings"	
"Seek Mode"	Selects the tuning mode of the radio. "Auto1": Automatic search for a station. "Auto2": Search in order of the stations in the Preset memory. "Manual": Normal manual tuning control.
"Auto Memory"	Memorizes 6 stations with good reception automatically. "YES"/"NO"
"Receive Mode"	Sets the receive mode of the HD Radio receiver. "Auto": Automatically tunes to analog broadcast when there is no digital broadcast. "Digital": Digital broadcasts only. "Analog": Analog broadcasts only.
"TAG Memory"*1	Displays the tag memory usage of HD Radio receiver. Up to 50 tags can be registered to this unit. "##/50"
"Tagging"*1	Turns ON / OFF the tag memory function of HD Radio receiver. "ON"/"OFF"

(_ : Factory setting)

*1 Only with KTC-HR300 (optional accessory) connected

- 5 Make a setting**
Turn the [Volume] knob to select a setting value, and then press the [Volume] knob.
- 6 Exit Menu List mode**
Press the [MENU] button for at least 1 second, and then press it again briefly.

HD Radio™ Tuner Control (Optional)

Function of remote control

Direct Access Tuning

Tuning in a desired radio station by entering the frequency.

1 Select the radio band

2 Enter Direct Access Tuning mode

Press the [DIRECT] button.

"----" is displayed.

3 Select Tuning item

Press the [DIRECT] button.

Pressing the [DIRECT] button each time switches the tuning items as follows.

Items	Display
Frequency	"----"
Channel	"HD--"
Cancelling Direct Access Tuning	---

4 Enter the frequency or Channel

Press the number buttons.

Example of frequency input:

Desired frequency	Press button
92.1 MHz (FM)	[9], [2], [1]
810 kHz (AM)	[8], [1], [0]

5 Tune in to the entered frequency

Press the [◀◀] or [▶▶] button.

Cancelling Direct Access Tuning

Press the [DIRECT] button on the remote control.



- You can enter the FM band frequency in steps of a minimum of 0.1 MHz.

Function of KTC-HR300 (optional accessory)

iTunes Tagging

Using an iTunes Tagging enabled HD Radio receiver you can tag your music. When you hear a song you enjoy on your local HD Radio station, you only have to press the [SEARCH MODE] button. The song's information will then be saved on this unit. The saved songs will then show up in a playlist called "Tagged" in iTunes the every next time you sync your iPod to your computer. So then you just need to click and then easily buy and download the song you were tagging directly from the Apple iTunes Music Store.

1 Enter iTunes tagging mode

Press the [SEARCH MODE] button.

"TAG" will be displayed when song information can be registered.



- Turn "ON" the "TAGGING" of <HD Radio™ Setting> (page 61) when using this function.
- Up to 50 TAGs (song's information) can be registered to this unit. When iPod is connected, the TAG information registered to this unit is transferred to the connected iPod.
- The memory usage can be checked by selecting "TAG MEMORY" of <HD Radio™ Setting> (page 61).

Basic Operations of Remote Control

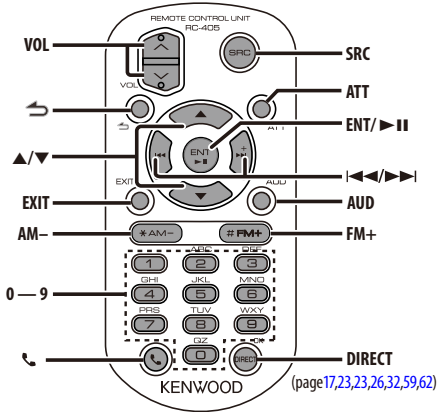

General control

- Volume control: **[VOL]**
- Source select: **[SRC]**
- Volume reduce: **[ATT]**
When the button is pressed again, the volume returns to the previous level.
- Return to previous item: **[↶]**
- Exit from mode: **[EXIT]**
- Selection of item: **[▲]/[▼]**
- Determination: **[ENT]**
- Enter Audio Control mode: **[AUD]**

In Tuner/HD Radio source

- Band select: **[FM+]/[AM-]**
- Station select: **[◀◀]/[▶▶]**
- Recall preset stations: **[1] — [6]**

In USB/ Internal Memory source

- Music select: **[◀◀]/[▶▶]**
- Folder select: **[FM+]/[AM-]**
- Pause/Play: **[▶II]**
- Movement between Menulist mode: **[▲]/[▼]**
- Return to previous folder: **[↶]**

In iPod source

- Movement between Menulist mode: **[▲]/[▼]**
- Return to previous item: **[↶]**
- Music select: **[◀◀]/[▶▶]**
- Pause/Play: **[▶II]**

In Satellite Radio tuner source

- Preset band select: **[FM]**
- Channel select: **[◀◀]/[▶▶]**
- Recall preset channels: **[1] — [6]**

Hands-free phone control

Making a call

- Enter the dialing method selection mode: [**☎**]
- Select a dialing method: [**ENT**]
- Number dial input:
Input a digit: [**0**] – [**9**]
Input "+": [**▶▶**]
Input "#": [**FM+**]
Input "*": [**AM-**]
Clear the entered phone number: [**◀◀**]
- Make a call: [**DIRECT**]

Receiving a call

- Answer the call: [**☎**]
- Switch between the private talk mode and the hands-free talk mode: [**ENT**]

Call waiting

- Answer Another Incoming Call with the Current Call Suspended: [**☎**]
- Answer another Incoming Call after Terminating the Current Call: [**SRC**]
- Continue the Current Call: [**1**]

During a call

- End the call: [**SRC**]

Preparing the remote control unit

Pull the battery sheet out from the remote control unit to the direction of the arrow.

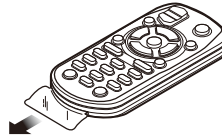

Changing the battery of the remote control unit

Use a commercially available button battery (CR2025). Insert the battery with the + and – poles aligned properly, following the illustration inside the case.

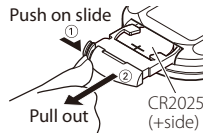

CAUTION

- Do not set the remote control in hot places such as on the dashboard.
- Lithium battery.
Danger of explosion if the battery is incorrectly replaced.
Replace only with the same or equivalent type.
- The battery pack or batteries shall not be exposed to excessive heat such as sunshine, fire or the like.
- Keep battery out of reach of children and in original package until ready to use. Dispose of used batteries promptly. If swallowed contact physician immediately.

Appendix

About Audio file

• Playable Audio file

- AAC-LC (.m4a)
- MP3 (.mp3)
- WMA (.wma)
- Linear PCM (WAV) (.wav)

• Playable USB device

USB mass storage class

• Playable USB device file system

FAT16, FAT32

Although the audio files are complied with the standards listed above, the play maybe impossible depending on the types or conditions of media or device.

• Playing order of the Audio file

In the example of folder/file tree shown below, the files are played in the order from ① to ⑩.

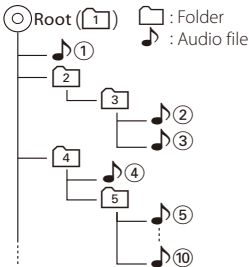

An online manual about audio files is put on the site, www.kenwood.com/cs/ce/audiofile/. On this online manual, detailed information and notes which are not written in this manual are provided. Make sure to read through the online manual as well.



- In this manual, the word "USB device" is used for flash memories and digital audio players which have USB terminals.

About Video files

• Acceptable video files

- H.264/MPEG-4 AVC (.mp4, .avi : Baseline Profile)
- MPEG-4 (.mp4, .avi : Simple Profile)
- WMV 9 (.wmv)

• Picture size

320 x 240 (QVGA), 160 x 120

• Acceptable media

Mass-storage-class USB device, iPod

Acceptable USB device file system, file and folder names and playing order are the same as those for audio files. See <About Audio files>.

About Picture files

• Acceptable picture files

- JPEG (.jpg)
- BMP (.bmp)

• Acceptable media

Mass-storage-class USB device

Acceptable USB device file system, file and folder names and playing order are the same as those for audio files. See <About Audio files>.

iPod/iPhone that can be connected to this unit

Made for

- iPod nano (1st generation) • iPod nano (2nd generation)
- iPod nano (3rd generation) • iPod nano (4th generation)
- iPod nano (5th generation) • iPod with video
- iPod classic • iPod touch (1st generation)
- iPod touch (2nd generation)

Works with

- iPhone • iPhone 3G • iPhone 3GS



iPhone
4GB 8GB 16GB



iPhone 3G
8GB 16GB



iPhone 3GS
16GB 32GB

- Update iPod/iPhone software to the latest version.
- Type of control available varies depending on the type of connected iPod. See www.kenwood.com/cs/ce/ipod/ for further details.
- The word "iPod" appearing in this manual indicates the iPod or the iPhone connected with the iPod connection cable. (Not supported model KCA-iP500) Refer to the web site for connectable iPod and iPod connection cable.

<http://www.kenwood.com/cs/ce/ipod/>



- If you start playback after connecting the iPod, the music that has been played by the iPod is played first. In this case, "RESUMING" is displayed without displaying a folder name, etc. Changing the browse item will display a correct title, etc.
- You cannot operate iPod if "KENWOOD" or "✓" displayed on iPod.

About USB device

- When the USB device is connected to this unit, it will be charged from the unit when the unit is turned on.
- Install the USB device in the place where it will not prevent you from driving your vehicle properly.
- Take backups of the audio files used with this unit. The files can be erased depending on the operating conditions of the USB device.
We shall have no compensation for any damage arising out of erasure of the stored data.
- No USB device comes with this unit. You need to purchase a commercially available USB device.
- When connecting the USB device, usage of the CA-U1EX (option) is recommended.
- Normal playback is not guaranteed when a cable other than the USB compatible cable is used. Connecting a cable whose total length is longer than 4 m can result in abnormal playback.

About USB device

- You can use the USB hub with up to 3 ports. The USB hub with 4 and more ports can also be used, but available ports are up to 3 of them.
- Do not connect more than 2 USB hubs to this unit. This unit cannot recognize the USB hubs if more than 2 USB hubs are connected.
- Only one iPod can be connected to a USB hub.
- Connect the Multi Card Reader directly to this unit. If connected to an USB hub, proper operation of the unit is not guaranteed.
- Playback cannot be resumed if more than one USB devices of the same model are connected to the USB hub.

About "KENWOOD Music Editor"

- This unit supports the PC application "KENWOOD Music Editor Lite ver1.0" or later.
- When you use the audio file with database information added by the "KENWOOD Music Editor Lite ver1.0", you can search a file by title, album or artist name using the <File Search> (page 15).
- In the Instruction manual, the term "Music Editor media" is used to mean the device that contains audio files with database information added with KENWOOD Music Editor.
- "KENWOOD Music Editor Lite ver1.0" is available from the following web site:
www.kenwood.com/cs/ce/
- For further information on "KENWOOD Music Editor Lite ver1.0", refer to the site above or the application help.

About the Cell-Phone

This unit conforms to the following Bluetooth specifications:

KIV-BT900

Version	Bluetooth Standard Ver. 2.0
Profile	HFP (Hands Free Profile) OPP (Object Push Profile) PBAP (Phone Book Access Profile) SYNC (Synchronization Profile)

KIV-700

You need to register your cell-phone to your Bluetooth Unit beforehand. Make sure to read the instruction manual of the Bluetooth Unit as well.

For the cell-phones verified for compatibility, access the following URL:

<http://www.kenwood.com/cs/ce/bt/>



- The units supporting the Bluetooth function have been certified for conformity with the Bluetooth Standard following the procedure prescribed by Bluetooth SIG. However, it may be impossible for such units to communicate with your cell-phone depending on its type.
- HFP is a profile used to make a hands-free call.
- OPP is a profile used to transfer data such as a phone book between units.

About Satellite Radio tuner (Optional)

This unit supports Satellite Radio tuners which are released by SIRIUS and XM. Refer to the instruction manual of Satellite radio tuner.

About HD Radio Reception (Optional)

When you connect an HD Radio tuner, Tuner features of the unit are disabled and changed to HD Radio tuner features. With the HD Radio tuner, you can use the similar functions of Tuner features.

Appendix

Menu List

Common function items

Display	Page
"Settings"	—
"Clock & Date"	38
"Clock Adjust"	
"Time Synchronized"	
"Summer Time"	
"Sub Clock Adjust"	
"Date Adjust"	
"Date Mode"	
"Display & Illumination"	—
"Display Select"	—
"Type Select"	36, 35
"Side Select"	36
"Text Select"	
"Graphic Select"	36, 35
"Display Off Mode"	34
"Display Dimmer"	
"Text Scroll"	
"Key Color Select"	35
"Key ILLUMI Dimmer"	34
"ILLUMI Effect"	
"ILLUMI Music SYNC"	
"Aspect Set"	
"Monitor Setup"	
"RDS Setting"	—
"TI"	24
"DEMO Mode"	39

Function items appearing during standby

Display	Page
"Settings"	—
"Clock & Date"	—
"Display & Illumination"	—
"Initial Settings"	—
"Source Select"	38
"Beep"	
"Menu Language Select"	
"Built in AUX"	
"Favorite Delete"	
"Built in AMP"	
"AV Out Set"	
"System F/W Update"	

Function items appearing when the iPod source is selected

Display	Page
"Music"	7
"Playlists"	
"Artists"	
"Albums"	
"Songs"	
"Podcasts"	
"Genres"	
"Composers"	
"Audiobooks"	
"Videos"	7
"Video Playlists"	
"Movies"	
"Music Videos"	
"TV Shows"	
"Video Podcasts"	
"Rentals"	
"Play Mode"	8
"iPod By Hand Mode"	
"Folder Random"	
"All Random"	
"File Repeat"	
"Port Up"	6
"Settings"	—
"Skip Search"	9
"Device F/W Version"	
"Delete My Playlist"	
"Audiobook Speed"	
"Sound Check"	
"Clock & Date"	—
"Display & Illumination"	—
"RDS Setting"	—

Function items appearing when the USB source is selected

Display	Page
"USB List"	15
"Copy from USB"	18
"Play Mode"	16
"File Scan"	
"Folder Random"	
"All Random"	
"File Repeat"	
"Folder Repeat"	
"Port Up"	14
"Drive Select"	14
"Slide"	20
"Save as Wallpaper"	20
"Settings"	–
"Device F/W Version"	17
"Device F/W Update"	
"Clock & Date"	–
"Display & Illumination"	–
"RDS Setting"	–

Function items appearing when the Music Internal media source is selected

Display	Page
"Music"	15
"Playlists"	
"Artists"	
"Albums"	
"Songs"	
"Genres"	
"Copy from USB"	18
"Play Mode"	16
"File Scan"	
"Folder Random"	
"File Repeat"	
"Port Up"	14
"Drive Select"	14
"Settings"	–
"Skip Search"	17
"Device F/W Version"	
"Device F/W Update"	
"Clock & Date"	–
"Display & Illumination"	–
"RDS Setting"	–

Function items appearing when the Zune source is selected

Display	Page
"Music"	15
"Genres"	
"Artists"	
"Albums"	
"Songs"	
"Playlists"	
"Play Mode"	16
"File Scan"	
"Folder Random"	
"File Repeat"	
"Port Up"	14
"Settings"	–
"Skip Search"	17
"Device F/W Version"	
"Clock & Date"	–
"Display & Illumination"	–
"RDS Setting"	–

Function items appearing when the Internal memory source is selected

Display	Page
"Internal Memory List"	15
"Play Mode"	16
"File Scan"	
"Folder Random"	
"All Random"	
"File Repeat"	
"Folder Repeat"	
"Settings"	–
"Internal Memory Delete"	19
"Internal Memory Format"	
"Clock & Date"	–
"Display & Illumination"	–
"RDS Setting"	–

Appendix

Function items appearing when the Disc changer source is selected

Display	Page
"Play Mode"	22
"Track Scan"	
"Disc Random"	
"Magazine Random"	
"Track Repeat"	
"Disc Repeat"	
"Settings"	—
"Clock & Date"	—
"Display & Illumination"	—
"RDS Setting"	—

Function items appearing when the Tuner source is selected

Display	Page
"List & Memory"	25, 25
"FM1"	24
"FM2"	
"FM3"	
"AM"	
"PTY Search"	27
"Settings"	—
"Seek Mode"	24
"Auto Memory"	25
"TI"	24
"TAG Memory"	
"Tagging"	
"Forced MONO"	
"Clock & Date"	—
"Display & Illumination"	—

Function items appearing when an AUX source is selected

Display	Page
"Settings"	—
"Name Set"	37
"Clock & Date"	—
"Display & Illumination"	—
"RDS Setting"	—

Function items appearing when the Hands-Free source is selected

Display	Page
"Preset Call"	31
"Phonebook"	32
"In Call"	32
"Out Call"	
"Missed Call"	
"SMS Inbox"	56
"Number Dial"	32
"BT Settings"	—
"Phone Selection"	52
"Audio Selection"	
"SMS Download"	56
"Voice Tag"	54
"Detailed Setup"	—
"Device Registration"	51
"Special Device Select"	
"Device Delete"	53
"PIN Code Edit"	52
"Auto Answer"	50
"Bluetooth HF/"	
"Bluetooth HF/Audio"	
"Call Beep"	
"BT F/W Update"	
"Mic Gain"	
"Noise Reduction"	
"Echo Cancel Level"	

Function items appearing when the Bluetooth Audio source is selected

Display	Page
"Settings"	—
"Audio Selection"	52
"Detailed Setup"	—
"Device Registration"	51
"Special Device Select"	
"Device Delete"	53
"PIN Code Edit"	52
"BT F/W Update"	50
"Clock & Date"	—
"Display & Illumination"	—
"RDS Setting"	—

Function items appearing when the Satellite Radio tuner source is selected

Display	Page
"List & Memory"	59, 59
"SR1"/"XM1"	58
"SR2"/"XM2"	
"SR3"/"XM3"	
"SR4"/"XM4"	
"Channel Search"	58
"Channel Scan"	59
"Settings"	—
"Seek Mode"	58
"ESN"	—
"Clock & Date"	—
"Display & Illumination"	—
"RDS Setting"	—

Function items appearing when the HD Radio™ tuner source is selected

Display	Page
"List & Memory"	60, 61
"FM1"	60
"FM2"	
"FM3"	
"AM"	
"Settings"	—
"Seek Mode"	61
"Auto Memory"	60
"Receive Mode:"	61
"TAG Memory"	—
"Tagging"	—
"Clock & Date"	—
"Display & Illumination"	—

Display Indicator items

Source	Display	Overview	
General	"ATT"	Indicates that the attenuator is active.	
	"FAV"	Indicates that the Favorite can be registered.	
iPod/USB	"MP3"	Identifies the MP3 file.	
	"WMA"	Identifies the WMA file.	
	"AAC"	Identifies the AAC-LC file.	
	"WAV"	Identifies the WAVE file.	
	"MPG4"	Identifies the MPEG4 file.	
	"H.264"	Identifies the H.264 file.	
	"WMV"	Identifies the WMV file.	
	"SCAN"	Indicates that the Scan function is ON.	
	"Fo-RDM"	Indicates that the Folder Random function is ON.	
	"ALL-RDM"	Indicates that the All Random function is ON.	
CD Changer	"Fo-REP"	Indicates that the Folder Repeat function is ON.	
	"Fi-REP"	Indicates that the File Repeat function is ON.	
	"SCAN"	Indicates that the Scan function is ON.	
	"RDM"	Indicates that the Track Random function is ON.	
	"M-RDM"	Indicates that the Magazine Random function is ON.	
	"D-REP"	Indicates that the Disc Repeat function is ON.	
	"T-REP"	Indicates that the Track Repeat function is ON.	
	"REP"	Indicates that the Repeat function is ON.	
	Tuner	"ST"	Indicates that stereo broadcast is being received.
		"TI"	Indicates the reception state of traffic information. (On: TP is being received. Blinking: TP is not being received.)
"TAG"		Indicates that Tagging is enabled.	
HD Radio	"HD A"	Indicates that analog broadcast is being received.	
	"HD D"	Indicates that digital broadcast is being received.	
	"M/S"	Indicates whether the reception channel is main or sub. (On: The channel is main. Blinking: The channel is sub.)	
	"MC"	Indicates that Multi channel is being received.	
	"ST"	Indicates that stereo broadcast is being received.	
	"TAG"	Indicates that Tagging is enabled.	
Hands-Free	"BT"	Bluetooth cell-phone connection status.	
		Battery level of cell-phone. Full > > > > Nearly dead	
		Indicates that the battery level of cell-phone cannot be obtained.	
		Signal strength of cell-phone. Maximum > > > Minimum	
	"OUT"	Indicates the out of coverage zone.	
		Indicates that the signal strength of cell-phone cannot be obtained.	
	"CALL WAIT"	Indicates call-waiting.	
	"PRIVATE"	Indicates that cell-phone is busy in the private mode.	

Appendix

Time zone list

Continent	City	Time Difference	
Area	Hawaii	-10:00	
	Alaska	-9:00	
	Pacific Time	-8:00	
	Arizona	-7:00	
	Mountain Time	-7:00	
	Central Time	-6:00	
	Eastern time	-5:00	
	Indiana	-5:00	
	Atlantic Time	-4:00	
	Mid-Atlantic	-2:00	
	W.Central Africa	+1:00	
	City	Abu Dhabi	+4:00
		Adelaide	+9:30
		Amman	+2:00
Amsterdam		+1:00	
Anchorage		-9:00	
Ankara		+2:00	
Athens		+2:00	
Atlanta		-5:00	
Auckland		+12:00	
Baghdad		+3:00	
Baku		+4:00	
Bangkok		+7:00	
Beijing		+8:00	
Beirut		+2:00	
Berlin		+1:00	
Bogotá		-5:00	
Brasilia		-3:00	
Brussels		+1:00	
Bucharest		+2:00	
Budapest		+1:00	
Buenos Aires		-3:00	
Cairo		+2:00	
Cape Verde Is.		-1:00	
Caracas		-4:30	
Chicago		-6:00	
Copenhagen		+1:00	
Denver		-7:00	
Detroit		-5:00	
Dhaka		+6:00	
Ekaterinburg		+5:00	
Harare		+2:00	
Helsinki		+2:00	
Hong Kong		+8:00	
Islamabad	+5:00		
Istanbul	+2:00		
Jakarta	+7:00		
Jerusalem	+2:00		
Johannesburg	+2:00		
Kabul	+4:30		

Continent	City	Time Difference
	Kansas City	-6:00
	Kathmandu	+5:45
	Kingston	-5:00
	Krasnoyarsk	+7:00
	Kuala Lumpur	+8:00
	Kuwait	+3:00
	Kyiv	+2:00
	Las Vegas	-8:00
	Lima	-5:00
	London	+0:00
	Los Angeles	-8:00
	Madrid	+1:00
	Magadan	+11:00
	Manila	+8:00
	Mexico City	-6:00
	Midway Is.	-11:00
	Minsk	+2:00
	Moscow	+3:00
	Nairobi	+3:00
	New Caledonia	+11:00
	New Delhi	+5:30
	New Orleans	-6:00
	New York	-5:00
	Newfoundland	-3:30
	Novosibirsk	+6:00
	Nuku'alofa	+13:00
	Oslo	+1:00
	Ottawa	-5:00
	Panama	-5:00
	Paris	+1:00
	Prague	+1:00
	Rome	+1:00
	San Francisco	-8:00
	Santiago	-4:00
	Sarajevo	+1:00
	Seattle	-8:00
	Singapore	+8:00
	St. Petersburg	+3:00
	Stockholm	+1:00
	Sydney	+10:00
	Taipei	+8:00
	Tehran	+3:30
	Tokyo	+9:00
	Toronto	-5:00
	Tunis	+1:00
	Vancouver	-8:00
	Vienna	+1:00
	Warsaw	+1:00
	Yangon	+6:30
	Zagreb	+1:00
	Zurich	+1:00

(GMT)

Appendix

FCC WARNING

This equipment may generate or use radio frequency energy. Changes or modifications to this equipment may cause harmful interference unless the modifications are expressly approved in the instruction manual. The user could lose the authority to operate this equipment if an unauthorized change or modification is made.

FCC NOTE

This equipment has been tested and found to comply with the limits for a Class B digital device, pursuant to Part 15 of the FCC Rules. These limits are designed to provide reasonable protection against harmful interference in a residential installation. This equipment may cause harmful interference to radio communications, if it is not installed and used in accordance with the instructions. However, there is no guarantee that interference will not occur in a particular installation. If this equipment does cause harmful interference to radio or television reception, which can be determined by turning the equipment off and on, the user is encouraged to try to correct the interference by one or more of the following measures:

- Reorient or relocate the receiving antenna.
- Increase the separation between the equipment and receiver.
- Connect the equipment into an outlet on a circuit different from that to which the receiver is connected.
- Consult the dealer or an experienced radio/TV technician for help.

- Contains Transmitter Module
FCC ID : RKXCK5000NVIA
- Contains Transmitter Module
IC ID: 5119A-CK5000NVIA

IC (Industry Canada) Notice

Operation is subject to the following two conditions:
(1) This device may not cause interference, and
(2) this device must accept any interference, including interference that may cause undesired operation of the device.

The term "IC:" before the certification/registration number only signifies that the Industry Canada technical specification were met.

This product contains a CR Coin Cell Lithium Battery which contains Perchlorate Material – special handling may apply.

See www.dtsc.ca.gov/hazardouswaste/perchlorate

- HD Radio™ and the HD Radio Ready logo are proprietary trademarks of iBiquity Digital Corporation.
- "Adobe Reader" is a trademark of Adobe Systems Incorporated.
- The "AAC" logo is a trademark of Dolby Laboratories.
- The Bluetooth word mark and logos are owned by the Bluetooth SIG, Inc. and any use of such marks by Kenwood Corporation is under license. Other trademarks and trade names are those of their respective owners.
- Microsoft, Zune™ and the Zune™ logo are trademarks of the Microsoft group of companies.
- iTunes is a trademark of Apple Inc.
- iPod is a trademark of Apple Inc., registered in the U.S. and other countries.
- iPhone is a trademark of Apple Inc.
- "Made for iPod" means that an electronic accessory has been designed to connect specifically to iPod and has been certified by the developer to meet Apple performance standards.
- "Works with iPhone" means that an electronic accessory has been designed to connect specifically to iPhone and has been certified by the developer to meet Apple performance standards.
- Apple is not responsible for the operation of this device or its compliance with safety and regulatory standards.

Accessories/ Installation Procedure

Accessories

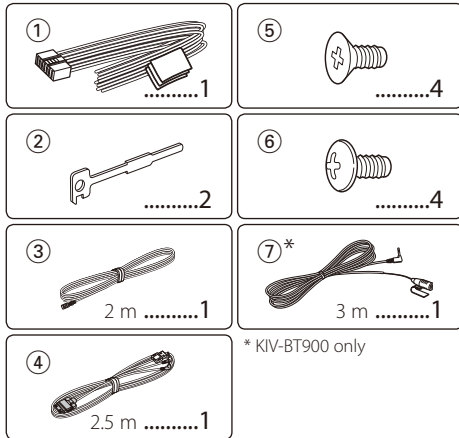

* KIV-BT900 only

Installation Procedure

- 1 To prevent a short circuit, remove the key from the ignition and disconnect the ⊖ battery.
- 2 Make the proper input and output wire connections for each unit.
- 3 Connect the speaker wires of the wiring harness.
- 4 Connect the wiring harness wires in the following order: ground, battery, ignition.
- 5 Connect the wiring harness connector to the unit.
- 6 Install the unit in your car.
- 7 Reconnect the ⊖ battery.
- 8 While pressing the [Volume] knob and the [MENU] button, press the [SRC] button for at least 3 seconds. See <How to reset your unit> (page 3).

⚠ WARNING

If you connect the ignition wire (red) and the battery wire (yellow) to the car chassis (ground), you may cause a short circuit, that in turn may start a fire. Always connect those wires to the power source running through the fuse box.



- Mounting and wiring this product requires skills and experience. For safety's sake, leave the mounting and wiring work to professionals.
 - Make sure to ground the unit to a negative 12V DC power supply.
 - Do not install the unit in a spot exposed to direct sunlight or excessive heat or humidity. Also avoid places with too much dust or the possibility of water splashing.
 - Do not use your own screws. Use only the screws provided.
- If you use the wrong screws, you could damage the unit.
- If the power is not turned ON ("Protect" is displayed), the speaker wire may have a short-circuit or touched the

chassis of the vehicle and the protection function may have been activated. Therefore, the speaker wire should be checked.

- If your car's ignition does not have an ACC position, connect the ignition wires to a power source that can be turned on and off with the ignition key. If you connect the ignition wire to a power source with a constant voltage supply, as with battery wires, the battery may die.
- If the fuse blows, first make sure the wires aren't touching to cause a short circuit, then replace the old fuse with one with the same rating.
- Insulate unconnected wires with vinyl tape or other similar material. To prevent a short circuit, do not remove the caps on the ends of the unconnected wires or the terminals.
- Connect the speaker wires correctly to the terminals to which they correspond. The unit may be damaged or fail to work if you share the ⊖ wires or ground them to any metal part in the car.
- When only two speakers are being connected to the system, connect the connectors either to both the front output terminals or to both the rear output terminals (do not mix front and rear). For example, if you connect the ⊕ connector of the left speaker to a front output terminal, do not connect the ⊖ connector to a rear output terminal.
- After the unit is installed, check whether the brake lamps, blinkers, wipers, etc. on the car are working properly.
- Reception may drop if there are metal objects near the Bluetooth antenna.



Bluetooth antenna unit

About CD players/disc changers connected to this unit

If the CD player/ disc changer has the "O-N" switch, set it to the "N" position.

The functions you can use and the information that can be displayed may differ depending on the models being connected.

For Good Reception

To assure good reception, note the following:

- Communicate with the cell-phone within the line-of-sight distance of 10 m (30 ft). The communication range becomes shorter depending on the surrounding environment. The communication range also becomes shorter when there is an obstacle between this unit and the cell-phone. The above maximum communication range (10 m) is not always assured.
- A broadcast station or walkie-talkie located nearby can interfere with communication due to too strong signal.

Connecting Wires to Terminals

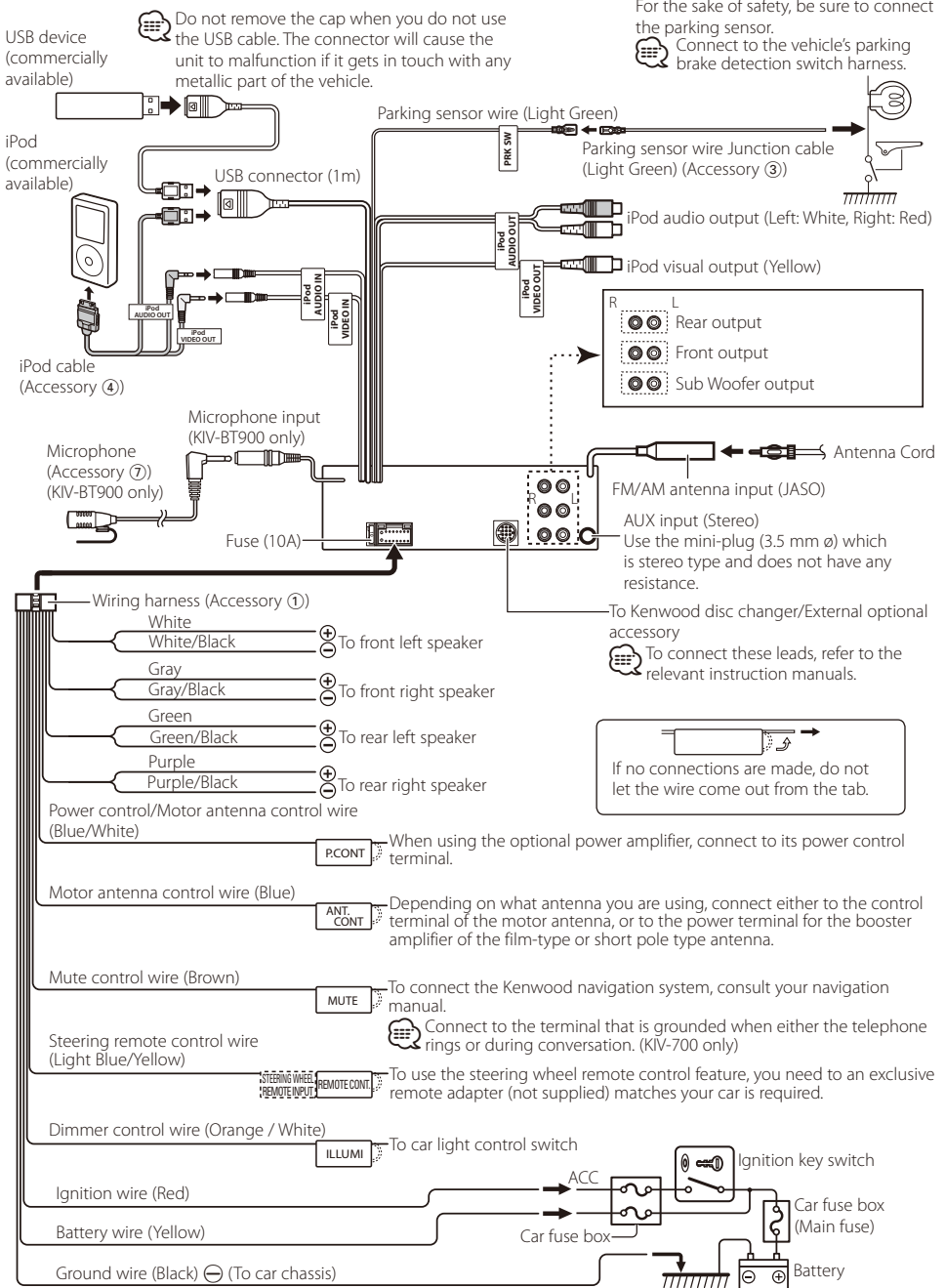

Installation/Removing the Unit

Non-Japanese Cars

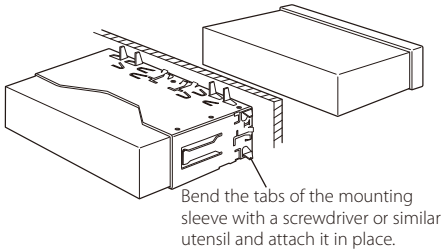

- Make sure that the unit is installed securely in place. If the unit is unstable, it may malfunction (for example, the sound may skip).

Japanese Cars

- 1 Refer to the section <Removing the Hard Rubber Frame> and then remove the hard rubber frame.
- 2 Align the holes in the unit (two locations on each side) with the vehicle mounting bracket and secure the unit with the accessory screws.

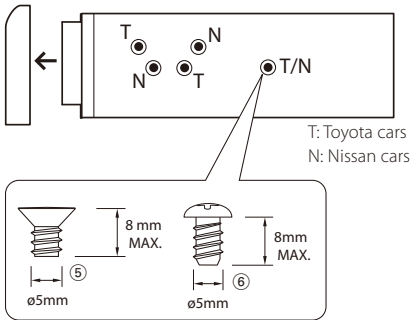

CAUTION

Install this unit in the console of your vehicle.
Do not touch the metal part of this unit during and shortly after the use of the unit. Metal part such as the heat sink and enclosure become hot.

Removing the Hard Rubber Frame

- 1 Engage the catch pins on the removal tool and remove the two locks on the upper level. Lift up and pull the frame forward as shown in the figure.

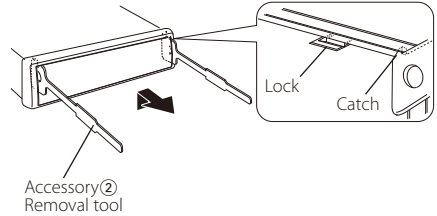

- 2 When the upper level is removed, remove the lower two locations.



- The frame can be removed from the bottom side in the same manner.

Removing the Unit

- 1 Refer to the section <Removing the Hard Rubber Frame> and then remove the hard rubber frame.
- 2 Insert the two removal tools deeply into the slots on each side, as shown.
- 3 Lower the removal tool toward the bottom, and pull out the unit halfway while pressing towards the inside.

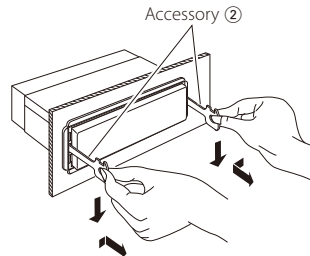

- Be careful to avoid injury from the catch pins on the removal tool.
- 4 Pull the unit all the way out with your hands, being careful not to drop it.

Installation/Removing the Unit

Accessory of KIV-BT900

Installation the Microphone Unit

- 1 Check the installation position of the microphone (accessory ⑦).
- 2 Remove oil and other dirt from the installation surface.
- 3 Install the microphone.
- 4 Wire the microphone cable up to the hands-free box with it secured at several positions using tape or the like.

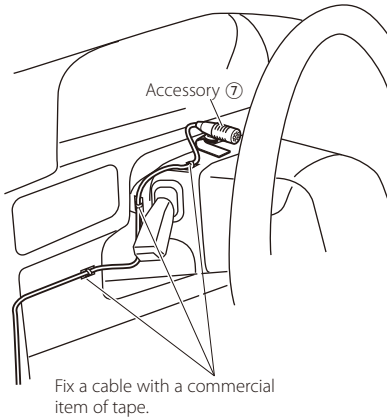

Fix a cable with a commercial item of tape.

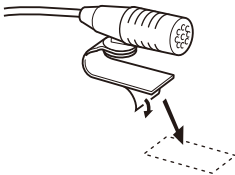

Peel the release coated paper of double-face adhesive tape to fix on the place shown above.



Adjust the direction of the microphone to the driver.



- Install the microphone as far as possible from the cell-phone.

Troubleshooting Guide

Some functions of this unit may be disabled by some settings made on this unit.

- !** • **Cannot set up the subwoofer.**
- **No output from the subwoofer.**
- **Cannot set up the subwoofer position of Manual position setting.**
 - ▶ The Dual zone function is enabled.
 - ☞ <Dual Zone System> (page 43)
 - In the speaker select option, None is selected for the subwoofer.
 - ☞ <Speaker Setting> (page 44)

- !** • **Cannot set up the equalizer.**
- **Cannot set up the Bass Boost.**
- **Cannot set up the Highway sound.**
- **Cannot set up the Supreme.**
- **Cannot set up the Position control.**
 - ▶ The Dual zone function is enabled.
 - ☞ <Dual Zone System> (page 43)
 - The DSP function is disabled.
 - ☞ "DSP Set" of <Audio Control> (page 40)
 - In the speaker select option, None is selected for the rear speakers.
 - ☞ <Speaker Setting> (page 44)

- !** • **Cannot select the output destination of the subsource in the Dual zone.**
- **Cannot adjust the volume of the rear speakers.**
 - ▶ The Dual zone function is disabled.
 - ☞ <Dual Zone System> (page 43)

- !** • **Cannot set up Display.**
 - ▶ <Demonstration Mode Setting> (page 39) is not turned off.

- !** • **Cannot switch to USB/iPod or Internal Memory source.**
 - ▶ The Dual zone function is set to USB/iPod or Internal Memory.
 - ☞ <Dual Zone System> (page 43)
 - ▶ AV output function is set to ON.
 - ☞ "AV Out Set" of <Initial Settings> (page 38)

- !** • **The number of songs contained in "Songs" category of this unit is different from that contained in "Songs" category of iPod.**
 - ▶ Podcast files are not counted in this unit as this unit does not support the playback of podcast files.

What might seem to be a malfunction in your unit may just be the result of slight misoperation or miswiring. Before calling service, first check the following table for possible problems.

General

- ?** • **The Touch Sensor Tone does not sound.**
 - ✓ The preout jack is being used.
 - ☞ The Touch Sensor Tone cannot be output from the preout jack.
-
- ?** • **The illumination flashes when the knob or button is operated.**
 - ✓ This is the key illumination effect.
 - ☞ You set this effect in "ILLUMI Effect" of <Display Setting> (page 34).
-
- ?** • **The key illumination effect brought about in conjunction with the sound volume is small.**
 - ✓ The key illumination effect may be insufficient depending on the sound volume and sound quality.

Tuner source

- ?** • **Radio reception is poor.**
 - ✓ The car antenna is not extended.
 - ☞ Pull the antenna out all the way.

Audio file source

- ?** • **The sound skips when an Audio file is being played.**
 - ✓ The recording condition is bad.
 - ☞ Record the media again or use another media.

Troubleshooting Guide

Hands-free

? The hands-free talk volume is low.

- ✓ The hands-free talk volume is set at a low level.
 - ☞ The hands-free talk volume can be adjusted independently. Adjust it during hands-free talk. "Mic Gain" and "Noise Reduction" <Bluetooth Setting> (page 50).

? No sound is heard from the rear speakers.

- ✓ You are talking in the hand-free talk mode.
 - ☞ No sound is heard from the rear speakers in the hands-free talk mode.

? No beep is heard at reception of an incoming call.

- ✓ No beep is heard depending on the type of your cell-phone.
 - ☞ The "Call Beep" of <Bluetooth Setting> (page 50) is set ON.

? Voice is not recognized.

- ✓ The vehicle window is open.
 - ☞ If the surrounding noise is large, voice cannot be recognized properly. Close the vehicle windows to reduce noise.
- ✓ Small voice.
 - ☞ If voice is too small, it cannot be recognized properly. Speak into the microphone a little more loudly and naturally.
- ✓ The person uttering the voice tag is not the one who registered the it.
 - ☞ Only the voice of the person who registered the voice tag can be recognized.

Bluetooth audio source

? The Bluetooth audio player cannot be registered (pairing).

- ✓ The PIN code is fixed.
 - ☞ When a PIN code is specified in the Instruction Manual for Bluetooth Audio Player, register it with reference to <Registering PIN Code> (page 52) to register the Bluetooth audio player. If no PIN code is specified in the Instruction Manual, try "0000".

? The sound from the Bluetooth audio player is discontinuous.

- ✓ The distance between this unit and audio player is too far.
 - ☞ Move the audio player nearer to this unit.
- ✓ Another Bluetooth device is affecting the Bluetooth communication.
 - ☞ Turn off another Bluetooth device.
 - ☞ Move another Bluetooth device away from this unit.
- ✓ Another Bluetooth device or profile is used for communication.
 - ☞ The downloading of the Phone book or the SMS disconnects the sound.

The messages shown below display your systems condition.

- TOC Error:
 - No disc has been loaded in the disc magazine.
 - The CD is quite dirty. The CD is upside-down. The CD is scratched a lot.
- Error 05: The disc is unreadable.
- Error 77: The unit is malfunctioning for some reason.
 - ☞ Press the reset button on the unit. If the "Error 77" code does not disappear, consult your nearest service center.
- Error 99: Something is wrong with the disc magazine. Or the unit is malfunctioning for some reason.
 - ☞ Check the disc magazine. And then press the reset button on the unit. If the "Error 99" code does not disappear, consult your nearest service center.
- Protect (Blink): The speaker wire has a short-circuit or touches the chassis of the vehicle, and then the protection function is activated.
 - ☞ Wire or insulate the speaker cable properly and press the reset button. If the "Protect" code does not disappear, consult your nearest service center.
- Unsupported File: An Audio file is played with a format that this unit can't support.
- Copy Protection: A copy-protected file is played.
- Read Error: The file system of the connected USB device is broken.
 - ☞ Copy the files and folders for the USB device again. If the error message is still displayed, initialize the USB device or use other USB devices.
- No Device: The USB device is selected as a source although no USB device is connected.
 - ☞ Change the source to any source other than USB. Connect an USB device, and change the source to USB again.
- N/A Device:
 - An unsupported USB device is connected.
 - Connection to the iPod has failed.
 - ☞ Check that the connected iPod is an iPod that is supported. See <iPod/iPhone that can be connected to this unit> (page 66) for information on supported iPods.
- No Media File/Error 15:
 - The connected USB device contains no playable audio file.
 - Media was played that does not have data recorded that the unit can play.

USB ERROR:	Some trouble may have occurred to the connected USB device. <ul style="list-style-type: none"> ➤ Remove the USB device, then cycle the power switch to ON. If the same display is repeated, use another USB device. 	No Entry:	The cell-phone has not been registered (pairing).
iPod Error:	Connection to the iPod has failed. <ul style="list-style-type: none"> ➤ Remove the USB device and then reconnect it. ➤ Confirm that the software for the iPod is the latest version. 	HF Disconnect:	The unit cannot communicate with the cell-phone.
USB REMOVE (Blink):	The Remove mode has been selected for the USB device/iPod. You can remove the USB device/iPod safely.	HF Error 07:	The memory cannot be accessed. <ul style="list-style-type: none"> ➤ Turn off the power and on again. If this message still appears, press the reset button on the control unit.
Over Capacity:	Recording or copying was canceled because internal memory space ran out while copying from USB device. <ul style="list-style-type: none"> ➤ Delete unnecessary files and record or copy once more. 	HF Error 68:	The unit cannot communicate with the cell-phone. <ul style="list-style-type: none"> ➤ Turn off the power and on again. If this message still appears, press the reset button on the control unit.
Copy Error:	<ul style="list-style-type: none"> • An incompatible digital audio player was used. • Cannot copy because the USB device is not firmly inserted. 	Un Known:	The Bluetooth device cannot be detected.
Delete Error:		Device Full:	5 Bluetooth device have already been registered. No more Bluetooth device cannot be registered.
Format Error:	Abnormal condition detected while deleting or formatting. <ul style="list-style-type: none"> ➤ Repeat the operation once more. This may take some time. If the message recurs, contact your nearest Kenwood dealer. 	PIN Code NG:	The PIN code is wrong.
Can't Download:		Connect NG:	The unit cannot be connected to the device.
Download Error:	This unit does not work properly for some reason. <ul style="list-style-type: none"> ➤ Press the reset button to download it again. If this error is still displayed, consult a local Kenwood dealer. ➤ Try all over again from the start. If this error is still displayed, consult a local Kenwood dealer. 	Pairing Failed:	Pairing error.
Writing Error:	Writing failed while the file was downloaded. <ul style="list-style-type: none"> ➤ Try the downloading again. 	Err No Matching:	The voice tag is wrong. Voice cannot be recognized because of an unregistered voice tag, etc.
Memory Full:	The TAG Memory of HD Radio or RDS is full.	Too Soft:	Voice is too small and cannot be recognized.
iPod Full:	The iPod Memory is full.	Too Loud:	Voice is too large to be recognized.
No TAG Function:	iPod which does not support the TAG Memory is connected.	Too Long:	The word or utterance is too long to be recognized.
N/A Channels:	No receivable channel and category.	No Phonebook:	Data is not contained in the phone book.
No Number:	<ul style="list-style-type: none"> • The calling party does not notify a caller ID. • There is no phone number data. 	No Message:	No short message in In Box.
No Data:	<ul style="list-style-type: none"> • There is no outgoing call list. • There is no incoming call list. • There is no missed call list. • There is no phone book list. 	No Record:	The voice tag is not registered in the phone book.
		Memory Full:	The number of voice tags reaches the maximum number to be registered in the phone book.
		Favorite: No Memory:	The procedure is not registered to Favorite Preset Memory
		No Access:	The procedure preset with Favorite Control cannot be available. The preset content may not be recalled depending on the selected source or mode.
		No Voice:	No call.

Specifications

FM tuner section

- Frequency Range (200 kHz Space)
 - : 87.9 MHz – 107.9 MHz
- Usable sensitivity (S/N = 30dB)
 - : 9.3dBf (0.8 μ V/75 Ω)
- Quieting Sensitivity (S/N = 50dB)
 - : 15.2dBf (1.6 μ V/75 Ω)
- Frequency response (\pm 3 dB)
 - : 30 Hz – 15 kHz
- Signal to Noise ratio (MONO)
 - : 70 dB
- Selectivity (\pm 400 kHz)
 - : \geq 80 dB
- Stereo separation (1 kHz)
 - : 40 dB

AM tuner section

- Frequency range (10 kHz space)
 - : 530 kHz – 1700 kHz
- Usable sensitivity (S/N = 20dB)
 - : 28 dB μ (25 μ V)

Bluetooth section (KIV-BT900)

- Version
 - : Bluetooth Ver. 2.0 Certified
- Frequency range
 - : 2.402 – 2.480 GHz
- Output Power
 - : +4dBm (MAX), 0dBm (AVE) Power Class 2
- Maximum Communication range
 - : Line of sight approx.10m (32.8 ft)
- Profiles
 - : HFP (Hands Free Profile)
 - : HSP (Headset Profile)
 - : SPP (Serial Port Profile)
 - : PBAP (Phone Book Access Profile)
 - : OPP (Object Push Profile)
 - : SYNC (Synchronization Profile)

USB Interface

- USB Standard
 - : USB 2.0 (Full speed)
- Maximum Supply current
 - : 5V, 500 mA
- File System
 - : FAT16/ 32
- D/A Converter
 - : 24 Bit
- Frequency response (\pm 1 dB)
 - : 10 Hz – 20 kHz
- Signal to Noise ratio (1 kHz)
 - : 110 dB
- Dynamic range
 - : 93 dB
- Video decode
 - : H.264/ MPEG4 AVC, MPEG 4, WMV
- Audio decode
 - : MP3, WMA, AAC, WAV (Linear PCM)

Monitor section

- Picture Size
 - : 3 inches (diagonal) wide
 - : 65.52 mm (W) x 36.84 mm (H)
- Display System
 - : Transparent TN LCD panel
- Drive System
 - : TFT active matrix system
- Number of Pixels
 - : 76,800 (320H x 240V x RGB)
- Pixel Arrangement
 - : RGB delta arrangement
- Back Lighting
 - : LED

Audio/ Video section

Maximum output power
: 50 W x 4
Full Bandwidth Power (at less than 1% THD)
: 22 W x 4
Speaker Impedance
: 4 – 8 Ω
Tone action
BAND1 (62.5 Hz): ± 9 dB
BAND2 (250 Hz): ± 9 dB
BAND3 (1 kHz): ± 9 dB
BAND4 (4 kHz): ± 9 dB
BAND5 (16 kHz): ± 9 dB
Preout level / Load (CD/CD-CH)
: 4000 mV/10 k Ω
Preout impedance
: $\leq 600 \Omega$
iPod terminal
Video output level : 1 V_{p-p} (75 Ω)
Audio output level : 1.2 V (10 k Ω)

Auxiliary input

Frequency response (± 1 dB)
: 20 Hz – 20 kHz
Input Maximum Voltage
: 1200 mV
Input Impedance
: 10 k Ω

General

Operating voltage
KIV-BT900 (10.5 – 16V allowable) : 14.4 V
KIV-700 (11 – 16V allowable) : 14.4 V
Maximum Current consumption
: 10 A
Installation Size (W x H x D)
: 182 x 53 x 158 mm
7-3/16 x 2-1/16 x 6-1/4 inch
Weight
: 2.6 lbs (1.20 kg)

- Specifications subject to change without notice.
- Although the effective pixels for the liquid crystal panel is given as 99.99% or more, 0.01% of pixels may not light or may light incorrectly.



This symbol mark indicates that Kenwood manufactured this product so as to decrease harmful influence on the environment.

KENWOOD