

KENWOOD

CD-RECEIVER

KDC-W5137
KDC-W5137Y

INSTRUCTION MANUAL

Kenwood Corporation



Contents

Safety precautions	3	Menu system	20
Notes	4	Menu System	
General features	7	Security Code	
Power		Touch Sensor Tone	
Selecting the Source		Manual Clock Adjustment	
Volume		Synchronize Clock	
Attenuator		DSI (Disabled System Indicator)	
Audio Control		Selectable Illumination	
Audio Setup		Display Illumination Control	
Bass Boost		Dimmer	
Speaker Setting		Switching preout	
Switching Display		Supreme Setting	
Subwoofer Output		News Bulletin with Timeout Setting	
Theft Deterrent Faceplate		Local Seek	
TEL Mute		Tuning Mode	
Tuner features	11	AF (Alternative Frequency)	
Tuning		Restricting RDS Region (Region Restrict Function)	
Direct Access Tuning		Auto TP Seek	
Station Preset Memory		Monaural Reception	
Auto Memory Entry		Auxiliary Input Display Setting	
Preset Tuning		Text Scroll	
RDS features	13	Selecting Russian Characters	
Traffic Information		Built-in Auxiliary input Setting	
Radio Text Scroll		Power OFF Timer	
PTY (Program Type)		CD Read Setting	
Program Type preset		Demonstration mode Setting	
Changing Language for PTY Function		Basic Operations of remote control	26
CD/Audio file/External disc control features	16	Accessories/ Installation Procedure	28
Playing CD & Audio file		Connecting Wires to Terminals	29
Playing External Disc		Installation	31
Fast Forwarding and Reversing		Troubleshooting Guide	33
Track/File Search		Specifications	35
Disc Search/Folder Search			
Direct Track/File Search			
Direct Disc Search			
Track/File/Disc/Folder Repeat			
Scan Play			
Random Play			
Magazine Random Play			
Folder Select			
Text/Title Scroll			

Safety precautions

⚠ WARNING

To prevent injury or fire, take the following precautions:

- To prevent a short circuit, never put or leave any metallic objects (such as coins or metal tools) inside the unit.
- Mounting and wiring this product requires skills and experience. For safety's sake, leave the mounting and wiring work to professionals.

Attach the panel while you are on the vehicle

The panel lock arm appears when the panel is removed. Therefore, the panel must be attached while the electrical system of the car is operating.

⚠ CAUTION

To prevent damage to the machine, take the following precautions:

- Make sure to ground the unit to a negative 12V DC power supply.
- Do not install the unit in a spot exposed to direct sunlight or excessive heat or humidity. Also avoid places with too much dust or the possibility of water splashing.
- Do not place the faceplate (and the faceplate case) in areas exposed to direct sunlight, excessive heat or humidity. Also avoid places with too much dust or the possibility of water splashing.
- To prevent deterioration, do not touch the terminals of the unit or faceplate with your fingers.
- Do not subject the faceplate to excessive shock, as it is a piece of precision equipment.
- When replacing a fuse, only use a new fuse with the prescribed rating. Using a fuse with the wrong rating may cause your unit to malfunction.
- Do not apply excessive force to the open faceplate or place objects on it. Doing so will cause damage or breakdown.
- Do not use your own screws. Use only the screws provided. If you use the wrong screws, you could damage the unit.

Do Not Load 8 cm (3 in.) CDs in the CD slot

If you try to load a 8 cm (3 in.) CD with its adapter into the unit, the adapter might separate from the CD and damage the unit.

About CD players/disc changers connected to this unit

Kenwood disc changers/ CD players released in 1998 or later can be connected to this unit.

Refer to the catalog or consult your Kenwood dealer for connectable models of disc changers/ CD players. Note that any Kenwood disc changers/ CD players released in 1997 or earlier and disc changers made by other makers cannot be connected to this unit.

Connecting unsupported disc changers/CD players to this unit may result in damage.

Set the "O-N" Switch to the "N" position for the applicable Kenwood disc changers/ CD players.

The functions you can use and the information that can be displayed may differ depending on the models being connected.



- You can damage both your unit and the CD changer if you connect them incorrectly.

Lens Fogging

When you turn on the car heater in cold weather, dew or condensation may form on the lens in the CD player of the unit. Called lens fogging, this condensation on the lens may not allow CDs to play. In such a situation, remove the disc and wait for the condensation to evaporate. If the unit still does not operate normally after a while, consult your Kenwood dealer.

The "AAC" logo is trademark of Dolby Laboratories.

Notes

- If you experience problems during installation, consult your Kenwood dealer.
- When you purchase optional accessories, check with your Kenwood dealer to make sure that they work with your model and in your area.
- The characters which can be displayed by this unit are A-Z 0-9 @ " ' ` % & * + - = , . / \ < > [] () ; : ^ - { } | ~ .
- The RDS feature won't work where the service is not supported by any broadcasting station.
- The illustrations of the display and the panel appearing in this manual are examples used to explain more clearly how the controls are used. Therefore, what appears on the display in the illustrations may differ from what appears on the display on the actual equipment, and some of the illustrations on the display may be inapplicable.

How to reset your unit

- If the unit fails to operate properly, press the Reset button. The unit returns to factory settings when the Reset button is pressed.
- Press the reset button if the disc auto changer fails to operate correctly. Normal operation should be restored.

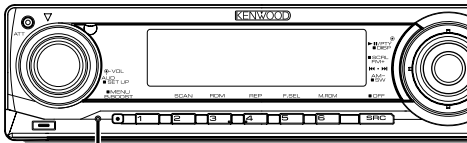

Reset button

Cleaning the Unit

If the faceplate of this unit is stained, wipe it with a dry soft cloth such as a silicon cloth.

If the faceplate is stained badly, wipe the stain off with a cloth moistened with neutral cleaner, then wipe it again with a clean soft dry cloth.



- Applying spray cleaner directly to the unit may affect its mechanical parts. Wiping the faceplate with a hard cloth or using a volatile liquid such as thinner or alcohol may scratch the surface or erase characters.

Cleaning the Faceplate Terminals

If the terminals on the unit or faceplate get dirty, wipe them with a clean soft dry cloth.

Before using this unit for the first time

This unit is initially set on the Demonstration mode.

When using this unit for the first time, cancel the <Demonstration mode Setting> (page 25).

About Audio file

• Playable Audio file

AAC (.m4a), MP3 (.mp3), WMA (.wma)

• Playable disc media

CD-R/RW/ROM

• Playable disc file format

ISO 9660 Level 1/2, Joliet, Romeo, Long file name.

Although the audio files are complied with the standards listed above, the play maybe impossible depending on the types or conditions of media or device.

• Playing order of the Audio file

In the example of folder/file tree shown below, the files are played in the order from ① to ⑩.

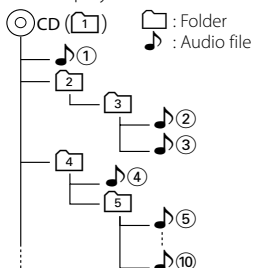

An online manual about audio files is put on the site, www.kenwood.com/audiofile/. On this online manual, detailed information and notes which are not written in this manual are provided. Make sure to read through the online manual as well.

Handling CDs

- Do not touch the recording surface of the CD.
- Do not stick tape etc. on the CD, or use a CD with tape stuck on it.
- Do not use disc type accessories.
- Clean from the center of the disc and move outward.
- When removing CDs from this unit, pull them out horizontally.
- If the CD center hole or outside rim has burrs, use the CD only after removing the burrs with a ballpoint pen etc.

CDs that cannot be used

- CDs that are not round cannot be used.

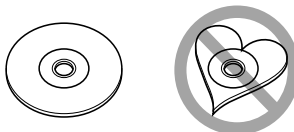

- CDs with coloring on the recording surface or CDs that are dirty cannot be used.
- This unit can only play the CDs with 

This unit may not correctly play discs which do not have the mark.

- You cannot play a CD-R or CD-RW that has not been finalized. (For the finalization process refer to your CD-R/CD-RW writing software, and your CD-R/CD-RW recorder instruction manual.)

About DAB Tuner control

Refer to [A] group on the Instruction manual of DAB Tuner KTC-9090DAB (optional accessory) for the control method of DAB Tuner function.

However, the following control methods of the function for this unit may be differed from the Instruction manual; therefore, refer to the following supplemental instruction.

<Auto Ensemble Memory Entry>

1. Select the preset band for Auto Ensemble Memory Entry.
2. Press the [AME] button for at least 2 seconds. Open Auto Ensemble Memory Entry. After storing in the memory finishes, the number of the pre-set buttons and the ensemble label are displayed.

<Searching by programme type and language> and <Languages to be displayed> in <Programme Type (PTY) Function>

At the operation to press [DISP] button, use [TI] button instead.

This Product is not installed by the manufacturer of a vehicle on the production line, nor by the professional importer of a vehicle into an EU Member State.

Information on Disposal of Old Electrical and Electronic Equipment (applicable for EU countries that have adopted separate waste collection systems)



Products with the symbol (crossed-out wheeled bin) cannot be disposed as household waste.

Old electrical and electronic equipment should be recycled at a facility capable of handling these items and their waste byproducts. Contact your local authority for details in locating a recycle facility nearest to you. Proper recycling and waste disposal will help conserve resources whilst preventing detrimental effects on our health and the environment.

The marking of products using lasers (Except for some areas)

**CLASS 1
LASER PRODUCT**

The label is attached to the chassis/case and says that the component uses laser beams that have been classified as Class 1. It means that the unit is utilizing laser beams that are of a weaker class. There is no danger of hazardous radiation outside the unit.

General features

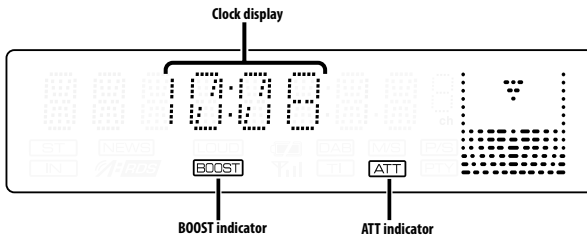
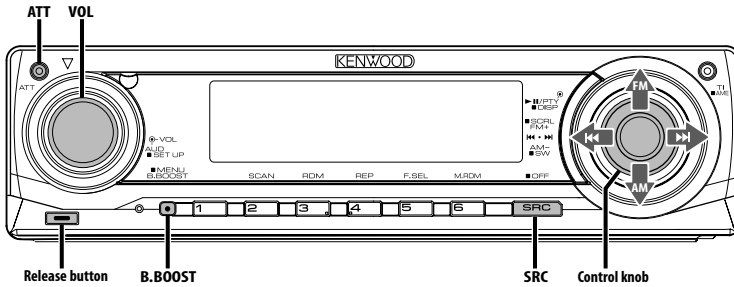

Power

Turning ON the Power

Press the [SRC] button.



- When the power is ON, the <Security Code> (page 20) is displayed as "CODE ON" or "CODE OFF".

Turning OFF the Power

Press the [SRC] button for at least 1 second.

Selecting the Source

Press the [SRC] button.

Source required	Display
Tuner	"TUNER"
CD	"CD"
External disc (Optional accessory)	"CD CH"
Auxiliary input	"AUX"
Auxiliary input (Optional accessory)	"AUX EXT"
Standby (Illumination only mode)	"STANDBY"



- This unit automatically turns full power OFF after 20 minutes lapses in Standby mode in order to save the vehicle's battery. The time until full power OFF can be set in <Power OFF Timer> (page 25).

Volume

Increasing Volume

Turn the [VOL] knob clockwise.

Decreasing Volume

Turn the [VOL] knob counterclockwise.

General features

Attenuator

Turning the volume down quickly.

Press the [ATT] button.

Each time you press the button, the Attenuator turns ON and OFF.

When the Attenuator is ON, the "ATT" indicator blinks.

Audio Control

1 Select the source to adjust

Press the [SRC] button.

2 Enter Audio Control mode

Press the [VOL] knob.

3 Select the Audio item to adjust

Press the [VOL] knob.

Each time you press the knob, the item to be adjusted alternates between the items shown in the table below.

4 Adjust the Audio item

Turn the [VOL] knob.

Adjustment Item	Display	Range
Subwoofer level	"SW L"	-15 — +15
System Q	"NATURAL"/"ROCK"/ "POPS"/"EASY"/"TOP40"/ "JAZZ"	Natural/Rock/ Pops/Easy/Top 40/ Jazz
Bass level	"BAS L"	-8 — +8
Middle level	"MID L"	-8 — +8
Treble level	"TRE L"	-8 — +8
Balance	"BAL"	Left 15 — Right 15
Fader	"FAD"	Rear 15 — Front 15

Exit Audio Control mode (Volume control mode)

About System Q

- You can recall the best sound setting preset for different types of music.
- Change each setting value with the <Speaker Setting> (page 9). First, select the speaker type with the Speaker setting.
- "USER": The ranges selected lastly for Bass level, Middle level, and Treble level are recalled automatically.

5 Exit Audio Control mode

Press any button.

Press a button other than the [VOL] knob and [ATT] button.

Audio Setup

Setting the Sound system, such as Volume offset.

1 Select the source to adjust

Press the [SRC] button.

2 Enter Audio Setup mode

Press the [VOL] knob for at least 1 second.

3 Select the Audio Setup item to adjust

Press the [VOL] knob.

Each time you press the knob, the item to be adjusted alternates between the items shown in the table below.

4 Adjust the Audio setup item

Turn the [VOL] knob.

Adjustment Item	Display	Range
Low Pass Filter	"LPF"	80/120/160/Through Hz
Volume offset	"V-OFF"	-8 — ±0 (AUX: -8 — +8)



- Volume offset: Sets each source's volume as a difference from the basic volume.

5 Exit Audio Setup mode

Press the [VOL] knob for at least 1 second.

Bass Boost

Bass sound can be enhanced by one-touch operation.

Press the [B.BOOST] button.

When you press the button once, the current Bass Boost setting is displayed.

Each time you press the button, the Bass Boost setting alternates.

Setting	Display
Bass Boost 1	"BB-L L1"
Bass Boost 2	"BB-L L2"
Bass Boost off	"BB-L OFF"

Speaker Setting

Fine-tuning so that the System Q value is optimal when setting the speaker type.

1 Enter Standby

Press the [SRC] button.

Select the "STANDBY" display.

2 Enter Speaker Setting mode

Press the [VOL] knob.

3 Select the Speaker type

Turn the [VOL] knob.

Each time you turn the knob, the setting alternates between the settings shown in the table below.

Speaker type	Display
OFF	"SP OFF"
For 5 & 4 in. speaker	"SP 5/4"
For 6 & 6x9 in. speaker	"SP 6*9/6"
For the OEM speaker	"SP OEM"

4 Exit Speaker Setting mode

Press the [VOL] knob.

Switching Display

Changing the information displayed.

1 Enter Switching Display mode

Press the Control knob for at least 1 second.

"DISP SEL" is displayed.

2 Select the Display item

Push the Control knob towards [◀◀] or [▶▶].

In Tuner source

Information	Display
Program Service name or Frequency (FM)	"FREQ/PS"
Radio text, Program Service name or Frequency (FM)	"R-TEXT"
Frequency (MW, LW)	"FREQ"
Clock	"CLOCK"

In CD & External disc source

Information	Display
Disc title	"D-TITLE"
Track title	"T-TITLE"
Track number & Play time	"P-TIME"
Clock	"CLOCK"

In Audio file source

Information	Display
Song title & Artist name	"TITLE"
Album name & Artist name	"ALBUM"
Folder name	"FOLDER"
File name	"FILE"
Track number & Play time	"P-TIME"
Clock	"CLOCK"

In Standby/ Auxiliary input source

Information	Display
Source name	"SRC NAME"
Clock	"CLOCK"

3 Exit Switching Display mode

Press the Control knob.



- If the selected display item does not have any information, alternative information is displayed.
- When you select the clock display, the display setting of each source will be changed to the clock display.
- Album name cannot be displayed in WMA file.

General features

Subwoofer Output

Turning the Subwoofer output ON or OFF.

Push the Control knob toward [AM] for at least 2 seconds.

Each time you push the knob, Subwoofer output switches ON and OFF.

When it is ON, "SW ON" is displayed.

Theft Deterrent Faceplate

The faceplate of the unit can be detached and taken with you, helping to deter theft.

Removing the Faceplate

1 Press the Release button.

Drop open the faceplate.

2 Drawing the faceplate to left side pull it to forward and remove it.

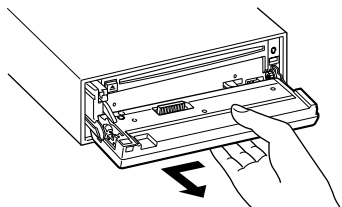

- The faceplate is a precision piece of equipment and can be damaged by shocks or jolts.
- Keep the faceplate in its faceplate case while detached.
- Do not expose the faceplate (and the faceplate case) to direct sunlight or excessive heat or humidity. Also avoid places with too much dust or the possibility of water splashing.

Reattaching the Faceplate

1 Align the shaft on the unit with the depression on the faceplate.

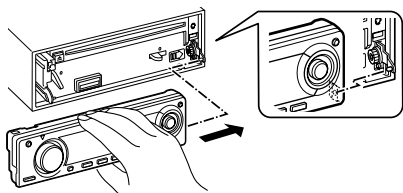

2 Push the faceplate in until it clicks.

The faceplate is locked in place, allowing you to use the unit.

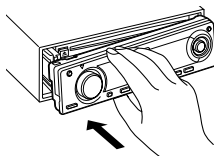

TEL Mute

The audio system automatically mutes when a call comes in.

When a call comes in

"CALL" is displayed.

The audio system pauses.

Listening to the audio during a call

Press the [SRC] button.

The "CALL" display disappears and the audio system comes back ON.

When the call ends

Hang up the phone.

The "CALL" display disappears and the audio system comes back ON.



- To use the TEL Mute feature, you need to hook up the MUTE wire to your telephone using a commercial telephone accessory. Refer to <Connecting Wires to Terminals> (page 29).

Tuner features

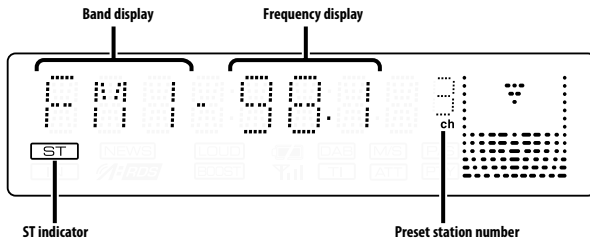
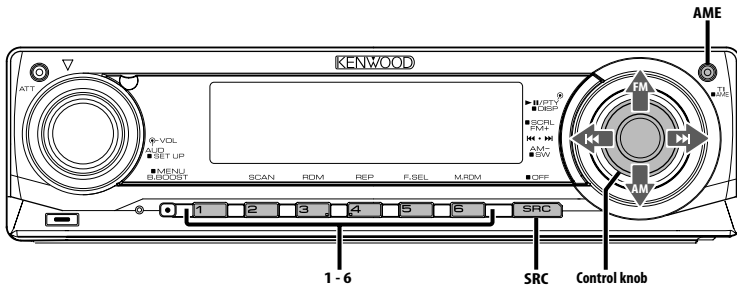

Tuning

Selecting the station.

1 Select tuner source

Press the [SRC] button.

Select the "TUNER" display.

2 Select the band

Push the Control knob towards [FM] or [AM].

Each time you push the knob toward [FM], it switches between the FM1, FM2, and FM3 bands.

3 Tune up or down band

Push the Control knob towards [◀◀] or [▶▶].



- During reception of stereo stations the "ST" indicator is ON.

Tuner features

Function of remote control

Direct Access Tuning

Entering the frequency and tuning.

1 Select the band

Press the [FM] or [AM] button.

2 Enter Direct Access Tuning mode

Press the [DIRECT] button on the remote control.

"----" is displayed.

3 Enter the frequency

Press the number buttons on the remote control.

Example:

Desired frequency	Press button
92.1 MHz (FM)	[0], [9], [2], [1]
810 kHz (AM)	[0], [8], [1], [0]

Cancelling Direct Access Tuning

Press the [DIRECT] button on the remote control.



- You can enter the FM band frequency in steps of a minimum of 0.1 MHz.

Station Preset Memory

Putting a station in the memory.

1 Select the band

Push the Control knob towards [FM] or [AM].

2 Select the frequency to put in the memory

Push the Control knob towards [◀] or [▶].

3 Put the frequency in the memory

Press the desired [1] — [6] button for at least 2 seconds.

The preset number display blinks 1 time.

On each band, 1 station can be put in the memory on each [1] — [6] button.

Auto Memory Entry

Putting stations with good reception in the memory automatically.

1 Select the band for Auto Memory Entry

Push the Control knob towards [FM] or [AM].

2 Open Auto Memory Entry

Press the [AME] button for at least 2 seconds.

"A-MEMORY" is displayed.

When 6 stations that can be received are put in the memory Auto Memory Entry closes.



- When the <AF (Alternative Frequency)> (page 23) is ON, only RDS stations are put in the memory.
- When Auto Memory Entry is done in the FM2 band, the RDS stations preset in the FM1 band are not put in the memory.
Likewise, when Auto Memory Entry is done in the FM3 band, RDS stations preset in FM1 or FM2 are not put in the memory.

Preset Tuning

Recalling the stations in the memory.

1 Select the band

Push the Control knob towards [FM] or [AM].

2 Recall the station

Press the desired [1] — [6] button.

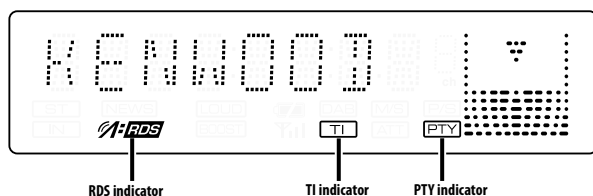
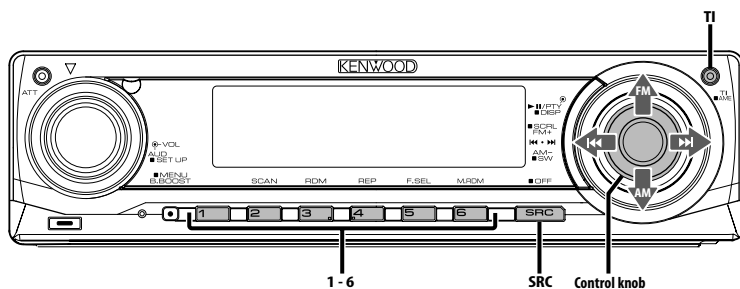

Traffic Information

Changing to traffic information automatically when a traffic bulletin starts even when you are not listening to the radio.

Press the [TI] button.

Each time you press the button, the Traffic information function turns ON and OFF. When traffic information is ON, "TI" indicator is ON. When a traffic information station is not being received the "TI" indicator blinks. When a traffic bulletin starts, "TRAFFIC" is displayed and the audio changes to traffic information.



- During reception of an AM station when the Traffic Information function is turned ON, the frequency changes to an FM station.
- During reception of traffic information the adjusted volume is automatically remembered, and the next time the audio changes to traffic information, the volume automatically becomes the remembered volume.

Receiving other traffic information stations

Push the Control knob towards [◀◀] or [▶▶].



- Traffic information can be switched when it is on the Tuner Source. However, you cannot switch the Traffic information during reception of the Traffic bulletin switched from the source other than the Tuner.

Radio Text Scroll

Scrolling the displayed radio text.

Push the Control knob toward [FM] for at least 2 seconds.



- When the <Display Illumination Control> (page 22) is set to OFF, the display may black out while scrolling.

PTY (Program Type)

Selecting the Program Type and searching for a station.

1 Enter PTY mode

Press the Control knob.

During PTY mode the "PTY" indicator is ON.



- This function cannot be used during a traffic bulletin or AM reception.

2 Select the Program Type

Push the Control knob towards [FM] or [AM].

Each time you push the knob, the Program Type alternates between program types shown in the table below.

No.	Program Type	Display
1.	Speech	"SPEECH"
2.	Music	"MUSIC"
3.	News	"NEWS"
4.	Current Affairs	"AFFAIRS"
5.	Information	"INFO"
6.	Sport	"SPORT"
7.	Education	"EDUCATE"
8.	Drama	"DRAMA"
9.	Culture	"CULTURE"
10.	Science	"SCIENCE"
11.	Varied	"VARIED"
12.	Pop Music	"POP M"
13.	Rock Music	"ROCK M"
14.	Easy Listening Music	"EASY M"
15.	Light Classical	"LIGHT M"
16.	Serious Classical	"CLASSICS"
17.	Other Music	"OTHER M"
18.	Weather	"WEATHER"
19.	Finance	"FINANCE"
20.	Children's programs	"CHILDREN"
21.	Social Affairs	"SOCIAL"
22.	Religion	"RELIGION"
23.	Phone In	"PHONE IN"
24.	Travel	"TRAVEL"
25.	Leisure	"LEISURE"
26.	Jazz Music	"JAZZ"
27.	Country Music	"COUNTRY"
28.	National Music	"NATION M"
29.	Oldies Music	"OLDIES"
30.	Folk Music	"FOLK M"
31.	Documentary	"DOCUMENT"



- Speech and Music include the Program type shown below.
Music: No.12 — 17, 26 — 30
Speech: No.3 — 11, 18 — 25, 31
- You can put the Program Type in the [1] — [6] button memory and for quick recall. Refer to the <Program Type preset> (page 14).
- You can change the display language. Refer to <Changing Language for PTY Function> (page 15).

3 Search for the selected Program Type station

Push the Control knob towards [◀◀] or [▶▶].

When you want to search for other stations, push [◀◀] or [▶▶] of the Control knob again.



- When the selected Program Type is not found, "NO PTY" is displayed. Select another Program Type.

4 Exit PTY mode

Press the Control knob.

Program Type preset

Putting the Program Type in the Preset button memory and quick recall.

Presetting the Program Type

1 Select the Program Type to preset

Refer to <PTY (Program Type)> (page 14).

2 Preset the Program Type

Press the desired [1] — [6] button for at least 2 seconds.

Recalling the preset Program Type

1 Enter PTY mode

Refer to <PTY (Program Type)> (page 14).

2 Recall the Program Type

Press the desired [1] — [6] button.

Changing Language for PTY Function

Selecting the Program Type display language.

1 Enter PTY mode

Refer to <PTY (Program Type)> (page 14).

2 Enter Changing Language mode

Press the [TI] button.

3 Select the language

Push the Control knob towards [FM] or [AM].

Each time you push the knob, the language alternates between the languages shown in the table below.

Language	Display
English	"ENGLISH"
French	"FRENCH"
German	"GERMAN"

4 Exit Changing Language mode

Press the [TI] button.

CD/Audio file/External disc control features

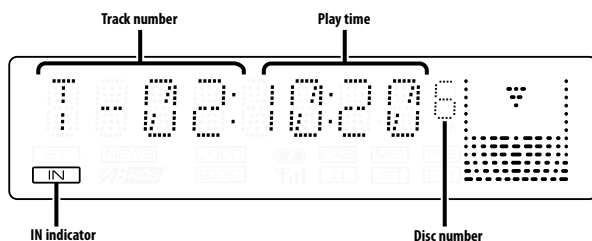
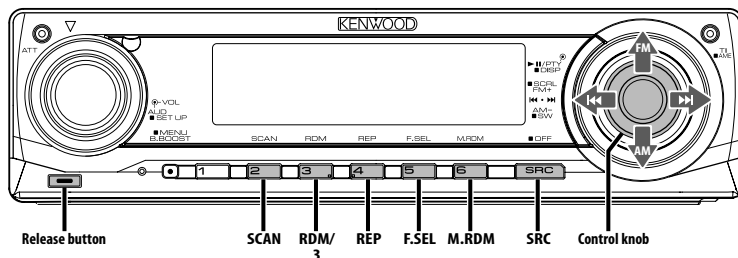

Playing CD & Audio file

When there is no disc inserted

- 1 Drop open the faceplate**
Press the Release button.
- 2** Insert a disc.
- 3 Push the faceplate on the left side, and return it to its former position.**



- When the faceplate has been dropped open, it might interfere with the shift lever or other vehicle function. If this happens, pay attention to safety and move the shift lever or take an appropriate action to remove the obstacle, then operate the unit.
- Do not use the unit with the faceplate in the open condition. If it's used in the open position dust can enter the inside part and cause damage.



- When a disc is inserted, the "IN" indicator is ON.

When a disc is inserted

Press the [SRC] button.
Select the "CD" display.

Pause and play

Press the Control knob.

Each time you press the knob, the audio pauses or plays.

Eject the disc

- 1 Drop open the faceplate**
Press the Release button.
- 2 Eject the disc**
Press the [▲] button.

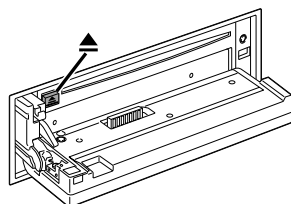

- 3 Press the faceplate on the left side, and return it to its former position.**



- You can eject the disc for 10 minutes after switching off the engine.

Playing External Disc

Playing discs set in the optional accessory disc player connected to this unit.

Press the [SRC] button.

Select the display for the disc player you want.

Display examples:

Display	Disc player
"CD CH"	CD changer
"MD CH"	MD changer

Pause and play

Press the Control knob.

Each time you press the knob, the audio pauses or plays.



- Disc 10 is displayed as "0".
- The functions that can be used and the information that can be displayed will differ depending on the external disc players being connected.

Fast Forwarding and Reversing

Fast Forwarding

Hold down toward [▶▶] with the Control knob.

Release to resume the playback.

Reversing

Hold down toward [◀◀] with the Control knob.

Release to resume the playback.



- There is no sound while the Audio file is being searched.
- The accurate track time is not displayed during fast forwarding or reversing of the Audio file.

Track/File Search

Searching for a song on the disc or in the Audio file folder.

Push the Control knob towards [◀◀] or [▶▶].

Function of disc changer/ Audio file

Disc Search/Folder Search

Selecting the disc set in the Disc changer or the folder recorded on the Audio file media.

Push the Control knob towards [FM] or [AM].

Function of remote control

Direct Track/File Search

Doing Track/File Search by entering the track/file number.

1 Enter the track/file number

Press the number buttons on the remote control.

2 Do Track/File Search

Press the [◀◀] or [▶▶] button.

Canceling Direct Track/File Search

Press the [▶||] button.

Function of disc changers with remote control

Direct Disc Search

Doing Disc Search by entering the disc number.

1 Enter the disc number

Press the number buttons on the remote control.

2 Do Disc Search

Press the [+] or [-] button.

Canceling Direct Disc Search

Press the [▶||] button.



- Input "0" to select disc 10.

CD/Audio file/External disc control features

Track/File/Disc/Folder Repeat

Replaying the song, disc in the Disc changer or Audio file folder you are listening to.

Press the [REP] button.

Each time you press the button, the Repeat Play alternates between the modes shown in the tables below.

In CD & External disc source

Repeat play	Display
Track Repeat	"TRAC REP"
Disc Repeat (In Disc Changer)	"DISC REP"
OFF	"REP OFF"

In Audio file source

Repeat play	Display
File Repeat	"FILE REP"
Folder Repeat	"FOLD REP"
OFF	"REP OFF"

Scan Play

Playing the first part of each song on the disc or Audio file folder you are listening to and searching for the song you want to hear.

1 Start Scan Play

Press the [SCAN] button.

"TRAC SCN"/"FILE SCN"/"SCAN ON" is displayed.

2 Release it when the song you want to listen to is played

Press the [SCAN] button.

Random Play

Play all the songs on the disc or Audio file folder in random order.

Press the [RDM] button.

Each time you press the button, Random Play turns ON or OFF.

When the Random mode is ON, "DISC RDM"/"FOLD RDM"/"RDM ON" is displayed.



- When you push the Control knob toward [▶▶], the next random song starts.

Function of disc changer

Magazine Random Play

Play the songs on all the discs in the disc changer in random order.

Press the [M.RDM] button.

Each time you press the button, the Magazine Random Play turns ON or OFF.

When the Magazine Random mode is ON, "MGZN RDM" is displayed.



- When you push the Control knob toward [▶▶], the next random song starts.

Function of Audio file

Folder Select

Quickly selecting the folder you want to hear.

1 Enter Folder Select mode

Press the [F.SEL] button.

"FLD SEL" is displayed.

During Select mode the folder information is displayed as shown below.

Folder name display

Displays the current folder name.

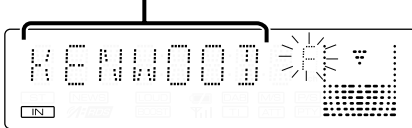

2 Select the folder level

Push the Control knob towards [FM] or [AM].

With the [FM] of the Control knob, you move 1 level down and with the [AM] of the Control knob, 1 level up.

Selecting a folder in the same level

Push the Control knob towards [◀◀] or [▶▶].

With the [◀◀] of the Control knob, you move to the previous folder, and with the [▶▶] of the Control knob, to the next folder.

Returning to the top level

Press the [3] button.

Scrolling the folder name display

Push the Control knob toward [FM] for at least 2 seconds.

3 Decide the folder to play

Press the Control knob.

The Folder Select mode releases, and the Audio file in the folder being displayed plays.

Canceling the Folder Select mode

Press the [F.SEL] button.

Text/Title Scroll

Scrolling the displayed CD text, Audio file text, or MD title.

Push the Control knob toward [FM] for at least 2 seconds.



- When the <Display Illumination Control> (page 22) is set to OFF, the display may black out while scrolling.

Menu system

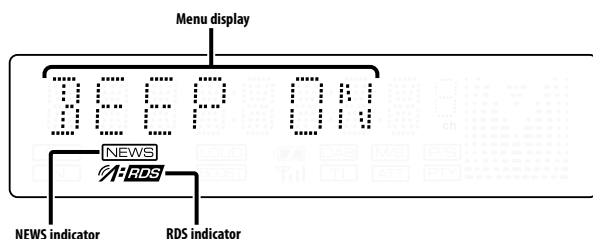
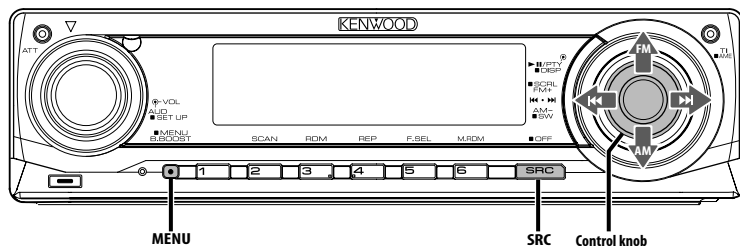

Menu System

Setting beep sound during operation, etc. functions.

The Menu system basic operation method is explained here. The reference for the Menu items and their setting content is after this operation explanation.

1 Enter Menu mode

Press the [MENU] button for at least 1 second.

"MENU" is displayed.

2 Select the menu item

Push the Control knob towards [FM] or [AM].

Example: When you want to set the beep sound select the "BEEP" display.

3 Set the menu item

Push the Control knob towards [◀◀] or [▶▶].

Example: When you select "BEEP", each time you push the knob it alternates between "BEEP ON" or "BEEP OFF". Select 1 of them as the setting.

You can continue by returning to step 2 and setting other items.

4 Exit Menu mode

Press the [MENU] button.



- When other items those applicable to the basic operation method above are displayed, their setting content chart is entered. (Normally the setting listed at the top of the chart is the original setting.) Also, the explanation for items that are not applicable (<Manual Clock Adjustment> etc.) are entered step by step.

In Standby mode

Security Code

Activating the Security Code disables the usage of audio unit by someone else. Once the Security Code is activated, the entry of authorized Security Code is required to turn on the audio unit when it is removed from the vehicle. Indication of this Security Code activation prevents your precious audio unit from stealing.



- When you activate the Security Code function, it cannot be released.

Note, your Security Code is the 4 digit number entered in your "Car Audio Passport" in this package.

1 Enter Standby

Press the [SRC] button.

Select the "STANDBY" display.

2 Enter Menu mode

Press the [MENU] button for at least 1 second.

When "MENU" is displayed, "CODE SET" is displayed.

3 Enter Security Code mode

Press the Control knob for at least 1 second.

When "ENTER" is displayed, "CODE" is also displayed.

4 Select the digits to enter

Push the Control knob towards [◀◀] or [▶▶].

5 Select the Security Code numbers

Push the Control knob towards [FM] or [AM].

6 Repeat step 4 and 5, and complete the Security Code.

7 Confirm the Security Code

Press the Control knob for at least 3 seconds.

When "RE-ENTER" is displayed, "CODE" is also displayed.

8 Do the step 4 through 7 operation, and reenter the security code.

"APPROVED" is displayed.

The Security Code function activates.

9 Exit Security Code mode

Press the [MENU] button.



- If you enter a Code different from your Security Code, you have to start over from step 4.

Resetting the Security Code function when the audio unit is first used after removed from the battery power source or the Reset button is pressed

1 Turn the power ON.

2 Do the step 4 through 7 operation, and reenter the security code.

"APPROVED" is displayed.

Now, you can use the unit.



- If an incorrect code is entered, "WAITING" is displayed, and the input prohibition periods shown in the table below is generated.

After the input prohibition time lapses, "CODE" is displayed, and you can reenter the code.

Number of times the incorrect code was input	Input prohibited time
1	—
2	5 minutes
3	1 hour
4	24 hours

In Standby mode

Touch Sensor Tone

Setting the operation check sound (beep sound) ON/OFF.

Display	Setting
"BEEP ON"	Beep is heard.
"BEEP OFF"	Beep canceled.

In Standby mode

Manual Clock Adjustment



- You can do this adjustment when the <Synchronize Clock> (page 22) is set as OFF.

1 Select Clock Adjustment mode

Press the Control knob towards [FM] or [AM].

Select the "CLK ADJ" display.

2 Enter Clock Adjust mode

Press the Control knob for at least 1 second.

The clock display blinks.

3 Adjust the hours

Push the Control knob towards [FM] or [AM].

Adjust the minutes

Push the Control knob towards [◀◀] or [▶▶].

4 Exit Clock adjustment mode

Press the [MENU] button.

Menu system

In Standby mode

Synchronize Clock

Synchronizing the RDS station time data and this unit's clock.

Display	Setting
"SYNC ON"	Synchronizes the time.
"SYNC OFF"	Adjust the time manually.



- It takes 3 to 4 minutes to synchronize the clock.

In Standby mode

DSI (Disabled System Indicator)

A red indicator will blink on the unit after the faceplate is removed, warning potential thieves.

Display	Setting
"DSI ON"	LED flashes.
"DSI OFF"	LED OFF.

In Standby mode

Selectable Illumination

Selecting the button illumination color as green or red.

Display	Setting
"KEY RED"	The illumination color is red.
"KEY GRN"	The illumination color is green.

Display Illumination Control

This function turns off the display when you perform no operation for 5 seconds. This function is effective when you are driving at night.

Display	Setting
"DISP ON"	Keeps the display on.
"DISP OFF"	Turns off the display when you perform no operation for 5 seconds.



- Set the Display Illumination Control when the <Demonstration mode Setting> (page 25) is set to OFF.
- When the display is off, pressing any key will turn on the display.
- When the display is off, you cannot perform any operation except for the following:
 - Volume
 - Attenuator
 - Selecting the source
 - Turning off the power
- During function control, such as the Menu System, the display stays on.

Dimmer

You can lower the brightness of the display by using the dimmer function.

Display	Setting
"DIM ON"	The display dims.
"DIM OFF"	The display doesn't dim.

In Standby mode

Switching preout

Alternating the preout between the rear and subwoofer. (With the subwoofer the sound outputs without being effected by fader control.)

Display	Setting
"SWPRE R"	Rear preout.
"SWPRE SW"	Subwoofer preout.

In Audio file source

Supreme Setting

When AAC, MP3 or WMA files encoded at a low bit rate (less than 96kbps (fs=32k, 44.1k, 48kHz)) are played, this function restores their high frequency region to approach the sound quality of equivalents of these files encoded at a high bit rate. Processing is optimized for the compression format used (AAC, MP3, or WMA), and adjustment is made for the bit rate used.

Display	Setting
"SPRM ON"	Plays sound using the Supreme function.
"SPRM OFF"	Plays the original sound stored in the audio file.



- The sound effect may be imperceptible depending on the relationship between the audio file format and setting.

News Bulletin with Timeout Setting

The tuner automatically changes when a news bulletin starts even if the radio is not being listened to. Also, you can set the time interval when interruption is prohibited.

Display and Setting
"NEWS OFF"
"NEWS 00M"
⋮
"NEWS 90M"

When you set "NEWS 00M" — "NEWS 90M", the News Bulletin Interrupt function is ON. When the News Bulletin is ON, the "NEWS" indicator is ON.

When the news bulletin starts, "NEWS" is displayed, and the tuner changes to the news bulletin.



- If you choose the "20MIN" setting, further news bulletins will not be received for 20 minutes once the first news bulletin is received.
- The news bulletin volume is the same level that was set for <Traffic Information> (page 13).

- This news bulletin function is only available if the desired station sends PTY-code for news bulletin or belongs to <Enhanced Other Network>-Network sending PTY-code for news bulletin.
- When the News Bulletin Interrupt function is ON, the tuner changes to an FM station.

In Tuner mode

Local Seek

Only stations whose reception is good are searched in auto seek tuning.

Display	Setting
"LO.S OFF"	The local seek function is OFF.
"LO.S ON"	The local seek function is ON.

In Tuner mode

Tuning Mode

Sets the tuning mode.

Tuning mode	Display	Operation
Auto seek	"AUTO 1"	Automatic search for a station.
Preset station seek	"AUTO 2"	Search in order of the stations in the Preset memory.
Manual	"MANUAL"	Normal manual tuning control.

AF (Alternative Frequency)

When the reception is poor, automatically alternate to another frequency broadcasting the same program in the same RDS network with better reception.

Display	Setting
"AF ON"	The AF function is ON.
"AF OFF"	The AF function is OFF.

When the AF function is ON, the "RDS" indicator is ON.



- When no other stations with stronger reception are available for the same program in the RDS network, you may hear the incoming broadcast in bits and snatches. Turn OFF the AF function in such a case.

Menu system

Restricting RDS Region (Region Restrict Function)

You can choose whether or not to restrict the RDS channels, received with the AF function for a particular network, to a specific region.

Display	Setting
"REG ON"	The Region Restrict Function is ON.
"REG OFF"	The Region Restrict Function is OFF.



- If AF function is not restricted to the specified region and network, the AF function sets up to search the station with good reception in the same RDS network.

Auto TP Seek

When the TI function is ON and the reception is poor while listening to a traffic information station, another traffic information station with better reception will be searched for automatically.

Display	Setting
"ATPS ON"	The Auto TP Seek Function is ON.
"ATPS OFF"	The Auto TP Seek Function is OFF.

In FM reception

Monaural Reception

You can reduce the noise when stereo broadcasts are received as monaural.

Display	Setting
"MONO OFF"	The monaural reception is OFF.
"MONO ON"	The monaural reception is ON.

Auxiliary Input Display Setting

Selecting the display when alternating to Auxiliary input source.

1 Select Auxiliary input source

Press the [SRC] button.

Select the "AUX"/"AUX EXT" display.

2 Enter Menu mode

Press the [MENU] button for at least 1 second.

"MENU" is displayed.

3 Select Auxiliary input display setting mode

Push the Control knob towards [FM] or [AM].

Select the "NAME SET" display.

4 Enter Auxiliary input display setting mode

Press the Control knob for at least 1 second.

The selected Auxiliary input display is displayed.

5 Select the Auxiliary input display

Push the Control knob towards [◀◀] or [▶▶].

Each time you push the knob, the display alternates as listed below.

- "AUX"/"AUX EXT"
- "DVD"
- "PORTABLE"
- "GAME"
- "VIDEO"
- "TV"

6 Exit Auxiliary input display setting mode

Press the [MENU] button.



- When operation stops for 10 seconds, the name at that time is registered, and the Auxiliary input display setting mode closes.
- You can only set the Auxiliary input display when the built-in auxiliary input or the auxiliary input of optional KCA-S220A is used.

Text Scroll

Setting the displayed text scroll.

Display	Setting
"SCL MANU"	Doesn't scroll.
"SCL AUTO"	Scrolls when the display changes.



- The text scrolled is listed below.
 - CD text
 - Folder name/ File name/ Song title/ Artist name/ Album name
 - MD title
 - Radio text

Function of KDC-W5137Y

In Standby mode

Selecting Russian Characters

Select Russian as a text display language.

Display	Setting
"RUS ON"	Displays texts using Russian characters.
"RUS OFF"	Displays texts using European characters.



- Texts displayed using Russian characters are as follows.
 - Folder name/ File name/ Song title/ Artist name/ Album name
 - CD text (internal CD source)
- Texts cannot distinguish upper case and lower case in Russian characters.



In Standby mode

Built-in Auxiliary input Setting

Set the Built-in Auxiliary Input function.

Display	Setting
"AUX OFF"	When selecting the source there's no Auxiliary Input.
"AUX ON"	When selecting the source there's Auxiliary Input.

In Standby mode

Power OFF Timer

Setting the timer to turn this unit's power OFF automatically when Standby mode continues. Using this setting can save the vehicle's battery power.

Display	Setting
"OFF -- --"	Power OFF Timer function is OFF.
"OFF 20M" (Original setting)	Turns the power OFF after 20 minutes.
"OFF 40M"	Turns the power OFF after 40 minutes.
"OFF 60M"	Turns the power OFF after 60 minutes.

In Standby mode

CD Read Setting

When there is a problem with playing a CD with special format, this setting plays the CD by force.

Display	Setting
"CD READ1"	Play CD and Audio file.
"CD READ2"	Play CD by force.



- Some music CDs may not play even in the "CD READ2" mode.

In Standby mode

Demonstration mode Setting

Sets the demonstration mode.

1 Select the Demonstration mode

Push the Control knob towards [FM] or [AM].
Select the "DEMO" display.

2 Set the Demonstration mode

Press the Control knob for at least 2 seconds.

Each time you press the knob at least 2 seconds, the Demonstration mode alternates between the settings shown in the table below.

Display	Setting
"DEMO ON"	The Demonstration mode function is ON.
"DEMO OFF"	Exit Demonstration mode (Normal mode).

Basic Operations of remote control

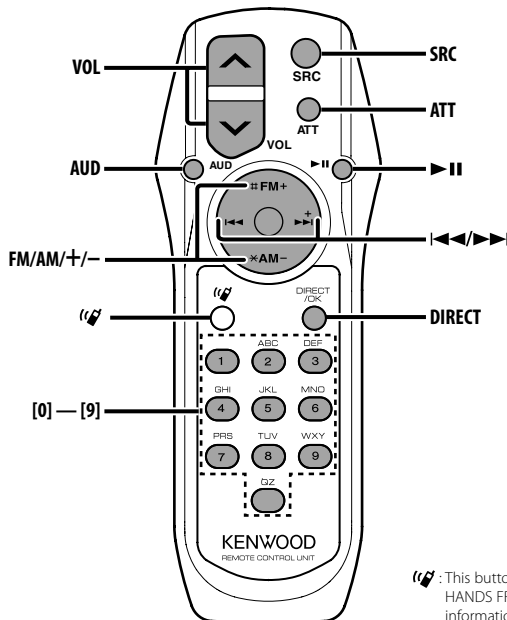

: This button is used when Kenwood Bluetooth HANDS FREE BOX is connected. For more information, refer to the instruction manual of Bluetooth HANDS FREE BOX.

Loading and Replacing the battery

Use two "AA"/ "R6"-size batteries.
Slide the cover while pressing downwards to remove it as illustrated.
Insert the batteries with the + and - poles aligned properly, following the illustration inside the case.

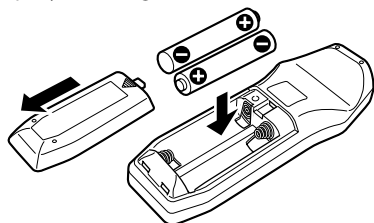

▲WARNING

- Store unused batteries out of the reach of children.
Contact a doctor immediately if the battery is accidentally swallowed.



- Do not set the remote control in hot places such as on the dashboard.

Basic operations

[VOL] buttons

Adjusts the volume.

[SRC] button

Each time you press the button, the source alternates.

For the source alternating order refer to <Selecting the Source> (page 7).

[ATT] button

Turns the volume down quickly.

When the button is pressed again, the volume returns to the previous level.

Audio Control

[AUD] button

Selects the Audio item to be adjusted.

[VOL] buttons

Adjusts the Audio item.



- Refer to <Audio Control> (page 8) for the operation method, such as the procedures for Audio control and others operations.

In Tuner source

[FM]/ [AM] buttons

Selects the band.

Each time you press the [FM] button, the band alternates between the FM1, FM2, and FM3 bands.

[◀◀]/ [▶▶] buttons

Tune up or down band.

[0] — [9] buttons

Press buttons [1] — [6] to recall preset stations.

[DIRECT] button

Enters and cancels the <Direct Access Tuning> (page 12) mode.

[▶ II] button

Enters and cancels the <PTY (Program Type)> (page 14) mode.

In Disc source

[◀◀]/ [▶▶] buttons

Going forwards and backwards between track/files.

[+]/ [-] buttons

Going forwards and backwards between disc/folders.

[▶ II] button

Each time you press the button, the song pauses or plays.

[0] — [9] buttons

When in <Direct Track/File Search> (page 17) and <Direct Disc Search> (page 17), enters the track/file/disc number.

Accessories/ Installation Procedure

Accessories

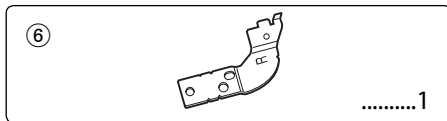
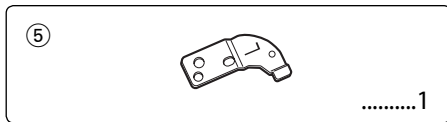
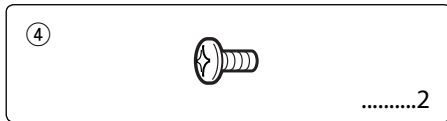
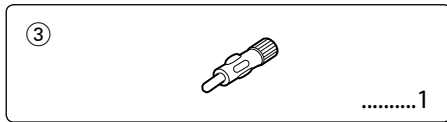
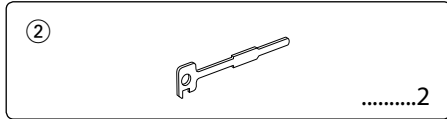
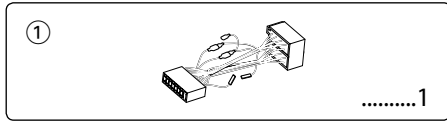

Installation Procedure

1. To prevent short circuits, remove the key from the ignition and disconnect the ⊖ terminal of the battery.
2. Make the proper input and output wire connections for each unit.
3. Connect the wire on the wiring harness.
4. Take Connector B on the wiring harness and connect it to the speaker connector in your vehicle.
5. Take Connector A on the wiring harness and connect it to the external power connector on your vehicle.
6. Connect the wiring harness connector to the unit.
7. Install the unit in your car.
8. Reconnect the ⊖ terminal of the battery.

9. Press the reset button.



- If the power is not turned ON ("PROTECT" is displayed), the speaker wire may have a short-circuit or touched the chassis of the vehicle and the protection function may have been activated. Therefore, the speaker wire should be checked.
- If your car is not prepared for this special connection-system, consult your Kenwood dealer.
- Only use antenna conversion adapters (ISO-JASO) when the antenna cord has an ISO plug.
- Make sure that all wire connections are securely made by inserting jacks until they lock completely.
- If your vehicle's ignition does not have an ACC position, or if the ignition wire is connected to a power source with constant voltage such as a battery wire, the power will not be linked with the ignition (i.e., it will not turn on and off along with the ignition). If you want to link the unit's power with the ignition, connect the ignition wire to a power source that can be turned on and off with the ignition key.
- If the fuse blows, first make sure that the wires have not caused a short circuit, then replace the old fuse with one with the same rating.
- Insulate unconnected wires with vinyl tape or other similar material. To prevent short circuits, also do not remove the caps on the ends of the unconnected wires or the terminals.
- Connect the speaker wires correctly to the terminals to which they correspond. The unit may receive damage or fail to work if you share the ⊖ wires and/or ground them to any metal part in the car.
- After the unit is installed, check whether the brake lamps, indicators, wipers, etc. on the car are working properly.
- If the console has a lid, make sure to install the unit so that the faceplate does not hit the lid when closing and opening.
- Mount the unit so that the mounting angle is 30° or less.

Connecting Wires to Terminals

To connect these leads, refer to the relevant instruction manuals.

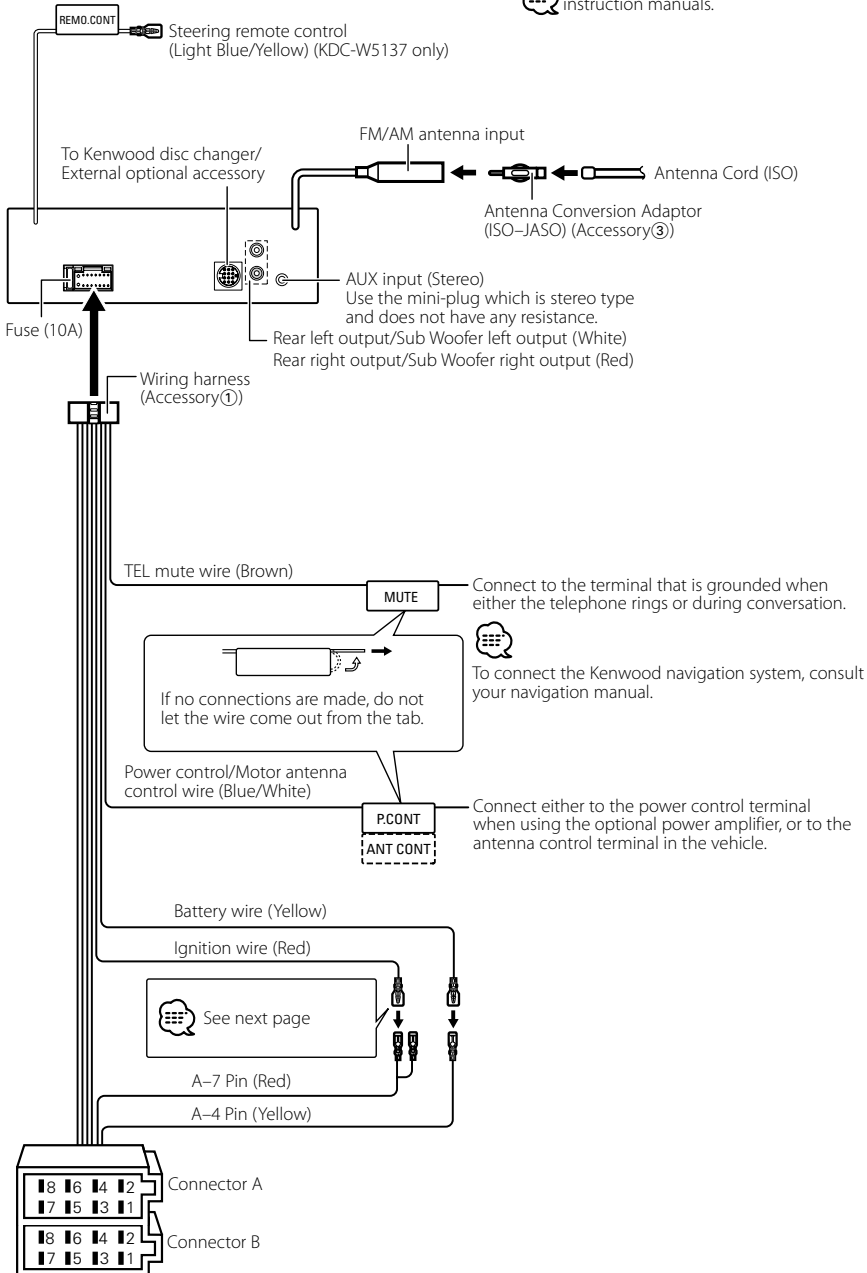

Connecting Wires to Terminals

Connector Function Guide

Pin Numbers for ISO Connectors	Cable Colour	Functions
External Power Connector		
A-4	Yellow	Battery
A-5	Blue/White	Power Control
A-7	Red	Ignition (ACC)
A-8	Black	Earth (Ground) Connection
Speaker Connector		
B-1	Purple	Rear Right (+)
B-2	Purple/Black	Rear Right (-)
B-3	Gray	Front Right (+)
B-4	Gray/Black	Front Right (-)
B-5	White	Front Left (+)
B-6	White/Black	Front Left (-)
B-7	Green	Rear Left (+)
B-8	Green/Black	Rear Left (-)

⚠ WARNING

Connecting the ISO Connector

The pin arrangement for the ISO connectors depends on the type of vehicle you drive. Make sure to make the proper connections to prevent damage to the unit.

The default connection for the wiring harness is described in [1] below. If the ISO connector pins are set as described in [2] or [3], make the connection as illustrated.

Please be sure to reconnect the cable as shown [2] below to install this unit to the **Volkswagen** vehicles etc.

- [1] (Default setting) The A-7 pin (red) of the vehicle's ISO connector is linked with the ignition, and the A-4 pin (yellow) is connected to the constant power supply.

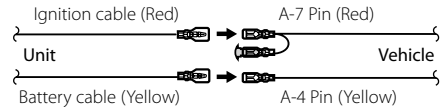

- [2] The A-7 pin (red) of the vehicle's ISO connector is connected to the constant power supply, and the A-4 pin (yellow) is linked to the ignition.

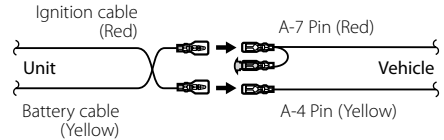

- [3] The A-4 pin (yellow) of the vehicle's ISO connector is not connected to anything, while the A-7 pin (red) is connected to the constant power supply (or both the A-7 (red) and A-4 (yellow) pins are connected to the constant power supply).

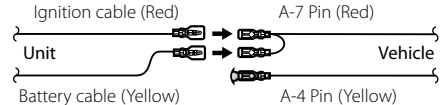

- When the connection is made as in [3] above, the unit's power will not be linked to the ignition key. For that reason, always make sure to turn off the unit's power when the ignition is turned off.

To link the unit's power to the ignition, connect the ignition cable (ACC...red) to a power source that can be turned on and off with the ignition key.

Installation

Installation

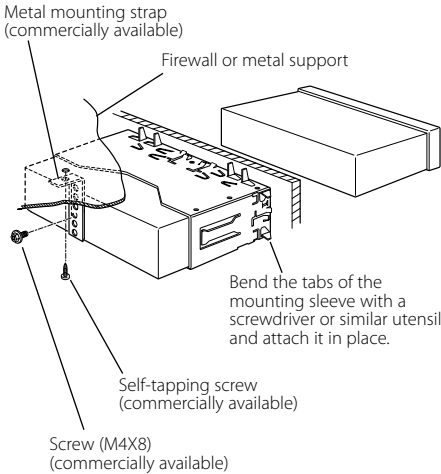

- Make sure that the unit is installed securely in place. If the unit is unstable, it may malfunction (for example, the sound may skip).

Screwing the Faceplate on the Unit

If you want to fasten the faceplate to the main unit so that it does not fall off.

- 1 Refer to the section <Removing the hard rubber frame> and then remove the hard rubber frame.
- 2 Drop open the faceplate by pressing the Release button.
- 3 Tighten the screw ($\varnothing 2 \times 5$ mm) (Accessory ④) and bracket (Accessory ⑤) in the hole shown on the diagram.

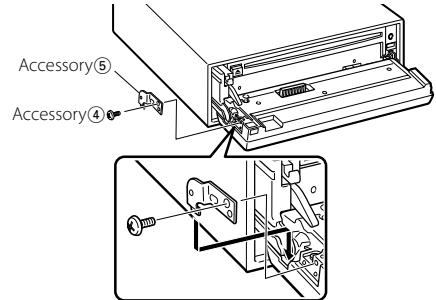

- 4 Tighten the screw ($\varnothing 2 \times 5$ mm) (Accessory ④) and bracket (Accessory ⑥) in the hole shown on the diagram.

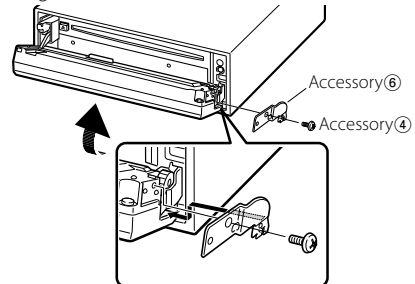

- Never insert the screws in any other screw hole than the one specified. If you screw them in another hole, it will contact and may cause damage to the mechanical parts inside the unit.

Installation

Removing the hard rubber frame

- 1 Engage the catch pins on the removal tool and remove the two locks on the upper level. Upper the frame and pull it forward as shown in the figure.

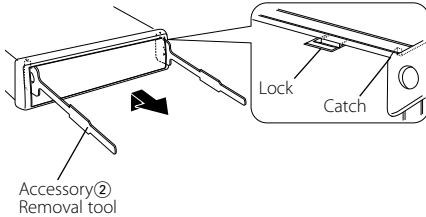

- 2 When the upper level is removed, remove the lower two locations.



- The frame can be removed from the bottom side in the same manner.

Removing the Unit

- 1 Refer to the section <Removing the hard rubber frame> and then remove the hard rubber frame.
- 2 Remove the screw (M4 × 8) on the back panel.
- 3 Insert the two removal tools deeply into the slots on each side, as shown.
- 4 Lower the removal tool toward the bottom, and pull out the unit halfway while pressing towards the inside.

Screw (M4X8)
(commercially available)

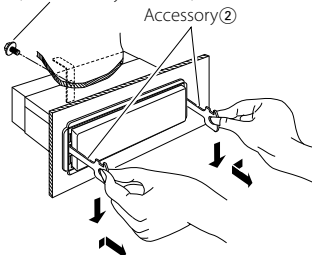

- Be careful to avoid injury from the catch pins on the removal tool.
- 5 Pull the unit all the way out with your hands, being careful not to drop it.

Troubleshooting Guide

Some functions of this unit may be disabled by some settings made on this unit.

! Cannot switch to Aux source.

- ▶ AUX is not turned on. ☞ <Built-in Auxiliary input Setting> (page 25)

! Cannot display the user of System Q.

- ▶ <Audio Control> (page 8) is not set.

! • Cannot set up the subwoofer.

- **No output from the subwoofer.**
- **Cannot set up the low pass filter.**
- ▶ • Preout is not set to subwoofer. ☞ <Switching preout> (page 22)
- <Subwoofer Output> (page 10) is not set to On.

! Cannot register a security code.

- ▶ <Demonstration mode Setting> (page 25) is not turned off.

! Cannot set up the Power-off timer.

- ▶ <Security Code> (page 20) is not set.

! Cannot play audio files.

- ▶ <CD Read Setting> (page 25) is set to "2".

What might seem to be a malfunction in your unit may just be the result of slight misoperation or miswiring. Before calling service, first check the following table for possible problems.

General

? The Touch Sensor Tone doesn't sound.

- ✓ The preout jack is being used.
- ☞ The Touch Sensor Tone can't be output from the preout jack.

Tuner source

? Radio reception is poor.

- ✓ The car antenna is not extended.
- ☞ Pull the antenna out all the way.
- ✓ The antenna control wire is not connected.
- ☞ Connect the wire correctly, referring to the section on <Connecting Wires to Terminals> (page 29).

Disc source

? The specified disc does not play, but another one plays instead.

- ✓ The specified CD is quite dirty.
- ☞ Clean the CD.
- ✓ The disc is loaded in a different slot from that specified.
- ☞ Eject the disc magazine and check the number for the specified disc.
- ✓ The disc is severely scratched.
- ☞ Try another disc instead.

Audio file source

? The sound skips when an Audio file is being played.

- ✓ The media is scratched or dirty.
- ☞ Clean the media, referring to the CD cleaning of the section on <Handling CDs> (page 5).
- ✓ The recording condition is bad.
- ☞ Record the media again or use another media.

Troubleshooting Guide

The messages shown below display your systems condition.

EJECT:	<ul style="list-style-type: none">• No disc magazine has been loaded in the changer. The disc magazine is not completely loaded.• No CD in the unit.	IN (Blink):	The CD player section is not operating properly. ↔ Reinsert the CD. If the CD cannot be ejected or the display continues to flash even when the CD has been properly reinserted, please switch off the power and consult your nearest service center.
NO DISC:	No disc has been loaded in the disc magazine.	PROTECT:	The speaker wire has a short-circuit or touches the chassis of the vehicle, and then the protection function is activated. ↔ Wire or insulate the speaker cable properly and press the reset button. If the "PROTECT" code does not disappear, consult your nearest service center.
TOC ERR:	<ul style="list-style-type: none">• No disc has been loaded in the disc magazine.• The CD is quite dirty. The CD is upside-down. The CD is scratched a lot.	NA FILE:	An Audio file is played with a format that this unit can't support. ↔ ----
E-05:	The disc is unreadable.	COPY PRO:	A copy-protected file is played. ↔ ----
BLANK:	Nothing has been recorded on the MD.	DEMO:	The Demonstration mode has been selected. ↔ The <Demonstration mode Setting> (page 25) is ON. Turn it OFF.
NO TRACK:	No tracks are recorded on the MD, although it has a title.		
E-15:	Media was played that doesn't have data recorded that the unit can play.		
NO PANEL:	The faceplate of the slave unit being connected to this unit has been removed.		
E-77:	The unit is malfunctioning for some reason. ↔ Press the reset button on the unit. If the "E-77" code does not disappear, consult your nearest service center.		
E-99:	Something is wrong with the disc magazine. Or the unit is malfunctioning for some reason. ↔ Check the disc magazine. And then press the reset button on the unit. If the "E-99" code does not disappear, consult your nearest service center.		
HOLD:	The protective circuit in the unit activates when the temperature inside the automatic disc changer exceeds 60°C (140°F), stopping all operation. ↔ Cool down the unit by opening the windows or turning on the air conditioner. As the temperature falls below 60°C (140°F), the disc will start playing again.		
LOAD:	Discs are being exchanged in the Disc changer.		
READING:	The unit is reading the data on the disc.		

Specifications

Specifications subject to change without notice.

FM tuner section

Frequency range (50 kHz space)
: 87.5 MHz – 108.0 MHz

Usable sensitivity (S/N = 26dB)
: 0.7 μ V /75 Ω

Quieting Sensitivity (S/N = 46dB)
: 1.6 μ V /75 Ω

Frequency response (\pm 3.0 dB)
: 30 Hz – 15 kHz

Signal to Noise ratio (MONO)
: 65 dB

Selectivity (DIN)(\pm 400 kHz)
: \geq 80 dB

Stereo separation (1 kHz)
: 35 dB

MW tuner section

Frequency range (9 kHz space)
: 531 kHz – 1611 kHz

Usable sensitivity (S/N = 20dB)
: 25 μ V

LW tuner section

Frequency range
: 153 kHz – 281 kHz

Usable sensitivity (S/N = 20dB)
: 45 μ V

CD player section

Laser diode
: GaAlAs

Digital filter (D/A)
: 8 Times Over Sampling

D/A Converter
: 1 Bit

Spindle speed
: 500 – 200 rpm (CLV)

Wow & Flutter
: Below Measurable Limit

Frequency response (\pm 1 dB)
: 10 Hz – 20 kHz

Total harmonic distortion (1 kHz)
: 0.01 %

Signal to Noise ratio (1 kHz)
: 105 dB

Dynamic range
: 93 dB

MP3 decode
: Compliant with MPEG-1/2 Audio Layer-3

WMA decode
: Compliant with Windows Media Audio

AAC decode
: AAC-LC ".m4a" files

Audio section

Maximum output power
: 50 W x 4

Output power (DIN 45324, +B=14.4V)
: 30 W x 4

Speaker impedance
: 4 - 8 Ω

Tone action
Bass : 100 Hz \pm 8 dB

Middle : 1 kHz \pm 8 dB

Treble : 10 kHz \pm 8 dB

Preout level / Load (during disc play)
: 2000 mV/10 k Ω

Preout impedance
: \leq 600 Ω

Auxiliary input

Frequency response (\pm 1 dB)
: 20 Hz – 20 kHz

Input Maximum Voltage
: 1200 mV

Input Impedance
: 100 k Ω

General

Operating voltage (11 – 16V allowable)
: 14.4 V

Current consumption
: 10 A

Installation Size (W x H x D)
: 182 x 53 x 155 mm

Weight
: 1.40 kg

KENWOOD