

KENWOOD

DPX-U5130BT DPX-U5130

DUAL DIN SIZED CD RECEIVER
INSTRUCTION MANUAL

JVC KENWOOD Corporation



Contents

Before use	4	Listen to the CD/ Audio file	20
Safety precaution		Playing music	
Important information		Music search	
Regulatory Compliance		Skip search ratio setting	
Appendix	5	Play function	
Trademarks		Direct music search	
Specifications		About the Audio file	
Basic operations	8	About the USB device	
Component names		About "KENWOOD Music Editor Light" and "KENWOOD Music Control"	
Preparations		About the discs used with this unit	
How to select the item		Handling discs	
Adjusting the clock		Listen to the tuner	23
General operations		Listening to the radio	
Audio adjustments	11	Station preset memory	
Audio control		Auto memory	
Listen to the iPod	12	Preset tuning	
Models of iPods/iPhones that can be connected to this unit		Tuner setting	
Playing music		Direct access tuning	
Music search		Frequency Step Setting	
Alphabet search		Listen to the AUX	25
Skip search ratio setting		Start listening	
Play function		Auxiliary input display setting	
APP & iPod Mode		Display settings	26
Pandora® internet radio	15	Illumination color selection	
Requirements Pandora® internet radio		Adjusting the Illumination color	
Listening to the Pandora® internet radio		Display & Illumination setting	
Basic operation		Text Display Selection	
Station search		Text scroll	
New station registration		General settings	28
Station preset memory		Muting the audio upon reception of a phone call	
Preset tuning		Demonstration mode setting	
Pandora source control		Initial settings	
Aha Radio	18	Registering a Bluetooth (Function of DPX-U5130BT)	30
Requirements Aha™		About the Bluetooth module	
Listening to the Aha Radio		Registering a Bluetooth device	
Basic operations		Selecting the Bluetooth device you wish to connect	
Station search		Deleting a registered Bluetooth device	
Calling a number in the content		Bluetooth device registration test	

Hands-free phoning (Function of DPX-U5130BT)	32
Receiving a call	
Calling a number in the phone book	
Alphabet search	
Dialing a number	
Calling a number in the call log	
Speed dialing (Preset dial)	
Registering in the preset dial number list	
During a call	
Switching between Two Connected Cell-phones	
Clearing the disconnection message	
Making a call by voice dialing	
Display of phone number types (categories)	
Bluetooth audio (Function of DPX-U5130BT)	35
Before use	
Basic operations	
Play function	
Bluetooth settings (Function of DPX-U5130BT)	36
Registering the PIN code	
Downloading the phone book	
Deleting the phone book	
Displaying the firmware version	
Bluetooth detail setting	
Basic operation of remote control	38
Before using remote control	
Basic operation	
Troubleshooting guide	40
Setting error	
Operation/wiring error	
Error messages	
Accessories/ Installation Procedure	43
Connecting Wires to Terminals	44
Installation	46

Before use

Safety precaution

▲ WARNING

To prevent injuries or a fire, take the following precautions:

- Stop the car before operating the unit.
- To prevent a short circuit, never put or leave any metallic objects (such as coins or metal tools) inside the unit.

▲ CAUTION

- Adjust the volume so that you can hear the sound outside the car. Driving with the volume too high may cause an accident.
- Wipe off the dirt on the panel with a dry silicon or soft cloth.
Failure to observe this precaution may result in damage to the monitor or unit.
- If you experience problems during installation, consult your Kenwood dealer.

Condensation

When the car is air-conditioned, moisture may collect on the laser lens. This may cause disc read errors. In this case, remove the disc and wait for the moisture to evaporate.

How to reset your unit

If the unit fails to operate properly, press the Reset button. The unit returns to the factory settings when the Reset button is pressed.

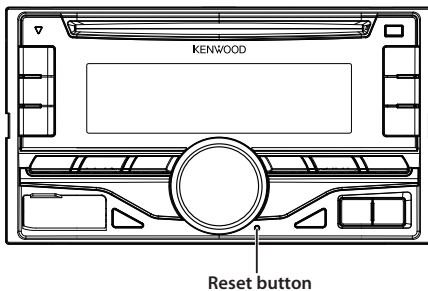

Important information

Notes

- If you experience problems during installation, consult your Kenwood dealer.
- When you purchase optional accessories, check with your Kenwood dealer to make sure that they can work with your model and in your area.
- Characters that conform to ISO 8859-1 can be displayed.
- The illustrations of the display and panel appearing in this manual are examples used to explain more clearly how the controls are used. Therefore, what appears on the display in the illustrations may differ from what appears on the display on the actual equipment, and some of the images on the display may be inapplicable.

Regulatory Compliance

The marking of products using lasers

**CLASS 1
LASER PRODUCT**

The label is attached to the chassis/case and says that the component uses laser beams that have been classified as Class 1. It means that the unit is utilizing laser beams that are of a weaker class. There is no danger of hazardous radiation outside the unit.

Appendix

Trademarks

- The “AAC” logo is a trademark of Dolby Laboratories.



- “Made for iPod” and “Made for iPhone” mean that an electronic accessory has been designed to connect specifically to iPod or iPhone, respectively, and has been certified by the developer to meet Apple performance standards. Apple is not responsible for the operation of this device or its compliance with safety and regulatory standards. Please note that the use of this accessory with iPod or iPhone may affect wireless performance.



- iPhone, iPod, iPod classic, iPod nano, and iPod touch are trademarks of Apple Inc., registered in the U.S. and other countries.
- iTunes is a trademark of Apple Inc.
- Microsoft and Windows Media are either registered trademarks or trademarks of Microsoft Corporation in the United States and/or other countries.



- The Bluetooth word mark and logos are owned by the Bluetooth SIG, Inc. and any use of such marks by JVC KENWOOD Corporation is under license. Other trademarks and trade names are those of their respective owners.



- PANDORA, the PANDORA logo, and the Pandora trade dress are trademarks or registered trademarks of Pandora Media, Inc., used with permission.



- aha, the Aha logo, and the Aha trade dress are trademarks or registered trademarks of HARMAN International Industries, used with permission.



- Android is a trademark of Google Inc.
- BlackBerry®, RIM®, Research In Motion® and related trademarks, names and logos are the property of Research In Motion Limited and are registered and/or used in the U.S. and countries around the world. Used under license from Research In Motion Limited.

Appendix

Specifications

FM tuner section

- Frequency range
 - 200 kHz space
 - : 87.9 MHz – 107.9 MHz
 - 50 kHz space
 - : 87.5 MHz – 108.0 MHz
- Usable sensitivity (S/N = 26dB)
 - : 7.2dBf (0.63 μ V/75 Ω)
- Quieting Sensitivity (DIN S/N = 46dB)
 - : 15.2dBf (1.6 μ V/75 Ω)
- Frequency response (\pm 3 dB)
 - : 30 Hz – 15 kHz
- Signal to Noise ratio (MONO)
 - : 75 dB
- Stereo separation (1 kHz)
 - : 45 dB

AM tuner section

- Frequency range
 - Band1 (MW) : 530 kHz – 1700 kHz (10 kHz space)
 - : 531 kHz – 1611 kHz (9 kHz space)
 - Band2 (SW1) : 2940 kHz – 7735 kHz (5 kHz space)
 - Band3 (SW2) : 9500 kHz – 10135 kHz / 11580 kHz
 - 18135 kHz (5 kHz space)
- Usable sensitivity (S/N = 20dB)
 - MW : 31 dB μ (36 μ V)
 - SW : 32 dB μ (40 μ V)

CD player section

- Laser diode
 - : GaAlAs
- Digital filter (D/A)
 - : 8 Times Over Sampling
- D/A Converter
 - : 24 Bit
- Spindle speed (Audio files)
 - : 500 – 200 rpm (CLV)
- Wow & Flutter
 - : Below Measurable Limit
- Frequency response (\pm 1 dB)
 - : 20 Hz – 20 kHz
- Total harmonic distortion (1 kHz)
 - : 0.01 %
- Signal to Noise ratio (1 kHz)
 - : 105 dB
- Dynamic range
 - : 90 dB
- MP3 decode
 - : Compliant with MPEG-1/2 Audio Layer-3
- WMA decode
 - : Compliant with Windows Media Audio
- AAC decode
 - : AAC-LC “.m4a” files

USB interface

- USB Standard
 - : USB1.1/ 2.0 (Full speed)
- File System
 - : FAT12/ 16/ 32
- Maximum Supply current
 - : DC 5 V \leq 1 A
- MP3 decode
 - : Compliant with MPEG-1/2 Audio Layer-3
- WMA decode
 - : Compliant with Windows Media Audio
- AAC decode
 - : AAC-LC “.m4a” files
- WAV decode
 - : Linear-PCM

Audio section

- Maximum output power
 - : 50 W x 4
- Full Bandwidth Power (at less than 1% THD)
 - : 22 W x 4
- Speaker Impedance
 - : 4 – 8 Ω
- Tone action
 - Bass : 100 Hz \pm 8 dB
 - Middle : 1 kHz \pm 8 dB
 - Treble : 12.5 kHz \pm 8 dB
- Preout level/ Load (CD)
 - : 2500 mV/10 k Ω
- Preout impedance
 - : \leq 600 Ω

Bluetooth section (DPX-U5130BT)

- Version
 - : Bluetooth Ver.2.1+EDR Certified
- Frequency range
 - : 2.402 – 2.480 GHz
- Output Power
 - : +4dBm (MAX), 0dBm (AVE) Power Class 2
- Maximum Communication range
 - : Line of sight approx.10m (32.8 ft)
- Profiles
 - : HFP (Hands Free Profile)
 - : SPP (Serial Port Profile)
 - : PBAP (Phonebook Access Profile)
 - : OPP (Object Push Profile)
 - : A2DP (Advanced Audio Distribution Profile)
 - : AVRCP (Audio/Video Remote Control Profile)

Auxiliary input

- Frequency response (\pm 3 dB)
 - : 20 Hz – 20 kHz
- Input Maximum Voltage
 - : 1200 mV
- Input Impedance
 - : 10 k Ω

General

- Operating voltage
 - DPX-U5130BT**
 - : 14.4 V (10.5 – 16V allowable)
 - DPX-U5130**
 - : 14.4 V (11 – 16V allowable)
- Maximum Current consumption
 - : 10 A
- Installation Size (W x H x D)
 - : 182 x 111 x 157 mm
- Weight
 - : 1.5 kg

Specifications subject to change without notice.

Basic operations

Component names

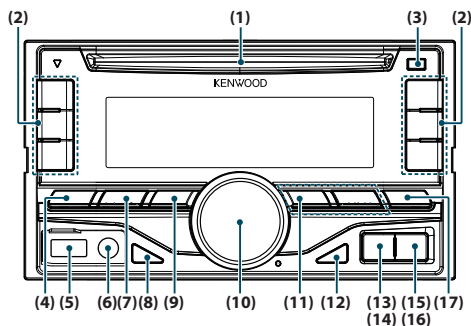

- (1) Disk slot
Insert a disc (label side up) in this slot.
- (2) [1] - [6] button
When listening to the radio, press the button to call a registered station.
When listening to the CD/USB/iPod, press the button to perform the following operations:
 - **DPX-U5130BT** [1] [2] : Selecting an audio file folder.
 - [3] : Selecting Random Play.
 - [4] : Selecting Repeat Play.
 - [5] : Selecting App & iPod Control Mode.
- (3) [▲] button
Press the button to eject the disc.
- (4) [SRC] button
Press the button to switch among sources.
- (5) USB terminal
Connect the iPod or USB device to this terminal.
- (6) Auxiliary input
Connect the output of an external device using a stereo mini-jack.
- (7) [Q] button
When listening to the iPod, audio file, or CD, press the button to enter the search mode.
When listening to the radio, press the button to select a band.
- (8) [DISP] button
Press the button to switch between display modes.
- (9) [↶] button
In each of the selected modes, press the button to return to the previous item.
- (10) [Control knob] (Volume knob)
In the normal mode, turn the knob to adjust the volume or press the knob to turn down the volume quickly.
In the Function mode, turn the knob to select an item or press the knob to determine the selection.
- (11) [◀◀/▶▶] button
Press the button to select a song or station.
- (12) [▶||] button
Press the button to switch between play/pause.
- (13) **DPX-U5130BT** [📞] button
Press the button to select the Phone Book.
- (14) **DPX-U5130** [▼] button
Press the button to select an audio file folder or broadcast band (AM), or use it as a thumbs down button on Pandora.
- (15) **DPX-U5130BT** [📞] button
Press the button to make, answer, or disconnect a hands-free call.
- (16) **DPX-U5130** [▲] button
Press the button to select an audio file folder or broadcast band (FM), or use it as a thumbs up button on Pandora.
- (17) [AUDIO] button
Press the button to enter the Audio Control mode.

Preparations

Exiting the Demonstration mode

Turn off the Demonstration mode when you use the unit for the first time after installation.

- 1 Press the [Control knob] to quit the Demonstration mode when the message “CANCEL DEMO PRESS VOLUME KNOB” appears (approx. 15 seconds).
- 2 Turn the [Control knob] to select the “YES” and then press the [Control knob].

The Demonstration mode can also be canceled in the Function Setting mode. Refer to <Demonstration mode setting> (page 28).

How to select the item

For how to select setting items such as a function setting item, see the following example:

Example: Adjusting the text scroll of the display

- 1 Press and hold the [AUDIO] button.
“Function” appears and enters the Function setting mode.
- 2 Select the Text scroll function item

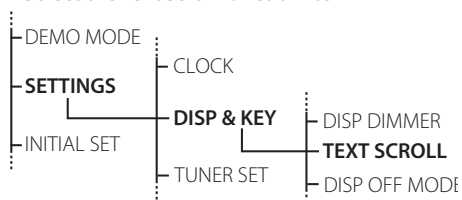

Turn the [Control knob] to select “SETTINGS”, and then press the [Control knob].
Next, turn the [Control knob] to select “DISP & KEY”, and then press the [Control knob].
Finally, turn the [Control knob] to select “TEXT SCROLL”, and then press the [Control knob].

Press the [↩] button to return to the previous item.

- 3 Turn the [Control knob] to select a value (AUTO, ONCE, OFF), and then press the [Control knob].

The previous item appears.

- 4 Press and hold the [↩] button.

Exit the Function setting mode.

About the description in this manual

“Function” appears and enters the Function setting mode.

- 2 Use the [Control knob] to select “SETTINGS” > “DISP & KEY” > “TEXT SCROLL”.
- 3 Use the [Control knob] to select a value (AUTO, ONCE, OFF).

Basic operations

Adjusting the clock

- 1 Press and hold the [Control knob].**
The hour display blinks.
- 2 Turn the [Control knob] to adjust the hour, and then press the [Control knob].**
The minute display blinks.
- 3 Turn the [Control knob] to adjust the minute, and then press the [Control knob].**

General operations

Power

- Turn the power on by pressing the [SRC] button.
- Press and hold [SRC] button to turn the power off.

Source selection

- Press the [SRC] button.
- Pressing the button switches among sources.

Source	Display
Standby	"STANDBY"
Tuner	"TUNER"
USB	"USB"
iPod[1]	"iPod"
Pandora® internet radio[1]	"PANDORA"
aha™[1][2]	"AHA"
Bluetooth audio[2]	"BT AUDIO"
CD[1]	"CD"
Auxiliary Input	"AUX"

- [1] This source can be selected only when it can be played.
- [2] Function of DPX-U5130BT.

Source switching setting

- "PANDORA", "AHA", and "AUX" sources are not selectable when not in use. For more details, see <Initial settings> (page 29).

Volume

- Turn the [Control knob].

USB terminal

- A USB device or iPod can be connected.
- The CA-U1EX (optional accessories) or KCA-iP102 (optional accessories) is recommended to connect a USB device or iPod.

Auxiliary input

- A portable audio device can be connected with a stereo mini-plug (3.5 mm ø).

Audio adjustments

Audio control

You can adjust the audio control items.

1 Select the source.

Refer to <Source selection> (page 10).

2 Press the [AUDIO] button.

Enter the Audio control mode.

3 Use the [Control knob] to select a audio item.

For how to use the [Control knob], refer to <How to select the item> (page 9).

Display	Audio setting item	Range
"SUB-W LEVEL"[2][3]	Subwoofer level	-15 — +15 (dB) (0)
"BASS LEVEL"	Bass level	-8 — +8 (dB) (8)
"MID LEVEL"	Middle level	-8 — +8 (dB) (2)
"TRE LEVEL"	Treble level	-8 — +8 (dB) (3)
"EQ PRO"		
"BASS ADJUST"		
"BASS CTR FRQ"	Bass Center Frequency	60/ 80/ 100 / 200 (Hz)
"BASS LEVEL"	Bass level	-8 — +8 (dB) (8)
"BASS Q FACTOR"	Bass Q Factor	1.00 / 1.25/ 1.50/ 2.00
"BASS EXTEND"	Bass Extend	OFF/ ON
"MID ADJUST"		
"MID CTR FRQ"	Middle Center Frequency	0.5/ 1.0/ 1.5/ 2.5 (kHz)
"MID LEVEL"	Middle level	-8 — +8 (dB) (2)
"MID Q FACTOR"	Middle Q Factor	0.75/ 1.00 / 1.25
"TRE ADJUST"		
"TRE CTR FRQ"	Treble Center Frequency	10.0/ 12.5 / 15.0/ 17.5 kHz
"TRE LEVEL"	Treble level	-8 — +8 (dB) (3)
"PRESET EQ"	Preset Equalizer curve	"ROCK"/ "POPS"/ "EASY"/ "TOP40"/ "JAZZ"/ " POWERFUL "/ "NATURAL"/ "USER"[1]
"BASS BOOST"	Bass Boost	"OFF"/ " LV1 "/ "LV2"/ "LV3"
"LOUDNESS"	Loudness	"OFF"/ "LV1"/ "LV2"
"BALANCE"	Balance	Left 15 — Right 15 (0)
"FADER"	Fader	Rear 15 — Front 15 (0)
"SUBWOOFER SET"[3]	Subwoofer output	OFF/ ON
"DETAILED SET"		
"HPF"[6]	High Pass Filter	Through / 100/ 120/ 150 (Hz)
"LPF SUBWOOFER"[2][3]	Low Pass Filter	85/ 120/ 160/ Through (Hz)
"SUB-W PHASE"[2][3][4]	Subwoofer Phase	Reverse (180°)/ Normal (0°)
"SUPREME SET"[5]	Supreme setting	ON / OFF
"VOLUME OFFSET"	Volume offset	-8 — ±0 (dB) (AUX: -8 — +8) (0)

(_ : Factory setting)

[1] "USER": The customized Bass, Middle, and Treble settings are effective.

[2] "SUB-W LEVEL"/ "LPF SUBWOOFER"/ "SUB-W PHASE" is selectable only if "SUBWOOFER SET" is set to "ON".

[3] SUB-W LEVEL"/ "SUBWOOFER SET"/ "LPF SUBWOOFER"/ "SUB-W PHASE" is selectable only if "SWITCH PREOUT" is set to "SUB-W". (DPX-U5130 only : See <"SWITCH PREOUT"> (page 29).

[4] "SUB-W PHASE" is selectable only if a setting other than "THROUGH" is selected for "LPF SUB-W".

[5] "SUPREME SET" is selectable only when playing back an MP3/WMA/AAC/WAV disc, USB device or iPod.

[6] Function of DPX-U5130BT.

Adjusting Bass, Middle, and Treble levels

- You can set Bass, Middle, and Treble levels for each source.

4 Use the [Control knob] to select a value.

The previous item appears.

Exit the Audio control mode.

Press and hold the [↵] button.

About Supreme

- Technology to extrapolate and supplement with proprietary algorithm, the high-frequency range that is cut off when encoding at low bit rate.

Supplementing is optimized by compression format (AAC, MP3, WMA or WAV) and processed according to bit rate. The effect is negligible with music that is encoded at high bit rate, variable bit rate or has minimal high frequency range.

Listen to the iPod

Models of iPods/iPhones that can be connected to this unit

Made for

- iPod nano (6th generation)
 - iPod nano (5th generation)
 - iPod nano (4th generation)
 - iPod nano (3rd generation)
 - iPod nano (2nd generation)
 - iPod nano (1st generation)
 - iPod with video
 - iPod classic
 - iPod touch (4th generation)
 - iPod touch (3rd generation)
 - iPod touch (2nd generation)
 - iPod touch (1st generation)
 - iPhone 4S
 - iPhone 4
 - iPhone 3GS
 - iPhone 3G
 - iPhone
- For information on the compatibility with iPod/iPhone software, visit www.kenwood.com/cs/ce/ipod/.
 - Types of available control vary depending on the type of connected iPod. Visit www.kenwood.com/cs/ce/ipod/ for further details.
 - The word "iPod" appearing in this manual indicates the iPod or the iPhone connected with the iPod connection cable (optional accessory).
 - Refer to the web site for connectable iPods and iPod connection cables.
www.kenwood.com/cs/ce/ipod/

Notes

- If you start playback after connecting the iPod, the music that was playing on the iPod is played first. In this case, "RESUMING" appears without displaying a folder name, etc. Changing the browse item will display a correct title, etc.
- You cannot operate the iPod if "KENWOOD" or "✓" appears on the iPod.

Playing music

Playing an iPod

Connect the iPod to the USB terminal using the KCA-iP102 connector (optional accessory).

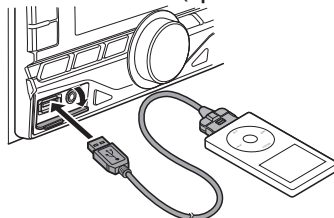

When it is connected, the source is switched automatically and playback starts.

When playback of iPod touch or iPhone does not start

- If an unsupported application has started when connecting iPod touch or iPhone, "APP&iPod MODE" appears and sometimes playback does not start. Press the [5] button (DPX-U5130BT) or press and hold the [iPod] button (DPX-U5130).

Selecting a song

Press the [◀◀] or [▶▶] button.

Fast-forwarding or fast-backwarding a song

Press and hold the [◀◀] or [▶▶] button.

Pause and play a song

Press the [▶||] button.

Removing iPod

Press the [SRC] button to switch the source to a device other than iPod, Pandora Internet radio, and Aha Radio, and then remove the iPod. Data contained in the iPod may be damaged if you remove it when it is used as the active source.

Music search

You can search for the song you want to play.

1 Press the [Q] button.

"SEARCH" appears and enters the Music search mode.

2 Search for a song

Operation type	Operation
Selecting items	Turn the [Control knob].
Determining selection	Press the [Control knob].
Skip Search	Press the [◀◀] or [▶▶]./ Press and hold the [◀◀] or [▶▶].
Returning to previous item	Press the [↶] button.
Returning to Top menu	Push the [5] button.

🎵 indicator: Audio file

👤 indicator: Artist

📀 indicator: Album

📁 indicator: Folder

Canceling the Music search mode

Press and hold the [↶] button.

Undisplayable titles

- If a song name can not be displayed for some reason, browse item name and digits are displayed (ex. PLIST***). instead.

Items	Display
Playlists	"PLIST***"
Artists	"ART***"
Albums	"ALB***"
Songs	"PRGM***"
Podcasts	"PDC***"
Genres	"GEN***"
Composers	"COM***"

Alphabet search

You can select an alphabetic character from the list in the browse item (artist, album, etc.) currently selected.

1 Press the [Q] button.

"SEARCH" appears and enters the Music search mode.

2 Press the [Q] button.

Enter the Alphabet search mode and "SEARCH <_ >" appears.

3 Select a character.

Operation type	Operation
Entry of character	Turn the [Control knob].
Movement of character entry position	Press the [◀◀] or [▶▶].
Determination of entered character	Press the [Control knob].

Returning to the Music search mode.

Canceling the Alphabet search mode

Press and hold the [↶] button.

Alphabet search notes

- Turning the [Control knob] fast in the Music search mode allows you to enter the alphabet search mode.
- The time of Alphabet search may become long depending on the number of items (songs) in iPod.
- To search for a character other than A to Z and 1, enter "**".
- If the first character string begins with an article "a", "an", or "the" in the alphabet search mode, it is searched for in defiance of the article.

Listen to the iPod

Skip search ratio setting

You can change the ratio of skip performed as mentioned in <Skip Search> (page 13).

1 Select the iPod source.

Refer to <Source selection> (page 10).

2 Press and hold the [AUDIO] button.

Enter the Function setting mode.

3 Use the [Control knob] to select "SETTINGS" > "SKIP SEARCH".

For how to use the [Control knob], refer to <How to select the item> (page 9).

4 Use the [Control knob] to select a ratio (0.5, 1, 5, 10).

The previous item appears.

Exit the Function setting mode

Press and hold the [↶] button.

Play function

Repeat play

Press the [4] button.

Switches between Repeat ("FILE REPEAT") and off ("REPEAT OFF") when pressed.

Random play

Press the [3] button.

Randomly plays the music.

Pressing the button toggles the setting between Random play on ("FOLDER RANDOM") and off ("RANDOM OFF").

Press this button again cancels the Random play.

All Random play

Press and hold the [3] button.

All songs in iPod are played at random.

Pressing the button toggles the setting between All random play on ("ALL RANDOM") and off ("RANDOM OFF").

Press this button again cancels the All Random play.

Notes

- The time required to turn on the all random function may become longer depending on the number of songs in iPod.
- Turning on the all random function changes the iPod browse item to "Songs". This browse item will not be changed even if the all random function is turned off.
- If the browse item is changed to search for music while the all random function is on, the all random function is turned off and the songs in the browse item are played at random.

APP & iPod Mode

Allowing you to operate iPod with the control on the iPod.

Press the [5] button.

When the APP & iPod mode is selected, "MODE ON" appears.

Canceling the APP & iPod mode

Press the [5] button.

Operation when "APP&iPod MODE" is "ON"

- When "APP&iPod MODE" is set to "ON", this unit can control only the "Pause and play", "Selecting a song", and "Fast Forward or Fast Backward of the Song" functions.

Pandora® internet radio (Function of iPhone®/ Bluetooth device)

Requirements Pandora® internet radio

Requirements for listening to the Pandora® internet radio are as follows:

- In the application on your device, log in and create an account with Pandora.
(If you are not already a registered user, an account can also be created at www.pandora.com.)
- Internet connection by 3G, LTE, EDGE, or WiFi.

iPhone or iPod touch

- Use an Apple iPhone or iPod touch running under iOS3 or later.
- Search for "Pandora" in the Apple iTunes App Store to find and install the most current version of the Pandora® application on your device.
- iPhone/ iPod touch connected to this unit with a KCA-iP102.

Android™

- Visit the Google play and search for Pandora to install.
- Bluetooth must be built in and the following profiles must be supported.
 - SPP (Serial Port Profile)
 - A2DP (Advanced Audio Distribution Profile)

BlackBerry®

- Visit www.pandora.com from the built in browser to download the Pandora application.
- Bluetooth must be built in and the following profiles must be supported.
 - SPP (Serial Port Profile)
 - A2DP (Advanced Audio Distribution Profile)

Notes

- Pandora® is currently available only in the U.S, Australia and New Zealand.
- Because Pandora® is a third-party service, the specifications are subject to change without prior notice. Accordingly, compatibility may be impaired or some or all of the services may become unavailable.
- Some functions of Pandora® cannot be operated from this unit.
- For issues using the application, please contact Pandora® at pandora-support@pandora.com

Listening to the Pandora® internet radio

Android or BlackBerry (DPX-U5130BT only)

- You need to register your cell-phone before using it with this unit. See <Registering a Bluetooth device> (page 30).
- Disconnect the iPhone or iPod touch.

1 Connect the Android/BlackBerry smartphone via Bluetooth.

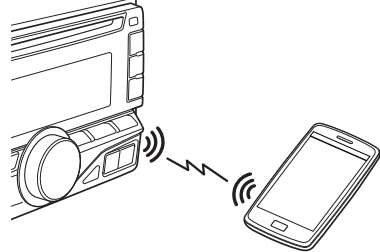

Speakers from which audio is output change depending on the Bluetooth setting "BT HF/AUDIO". The default is Front. See <Bluetooth detail setting> (page 37).

2 Open the Pandora® application on your device.

3 Press the [SRC] button to select a Pandora ("PANDORA") source.

Refer to <Source selection> (page 10).

iPhone or iPod touch

1 Open the Pandora® application on your device.

2 Open the cover.

3 Connect the iPod to the USB terminal using the KCA-iP102 connector (optional accessory).

The source switches, and broadcasting starts automatically from your current station.

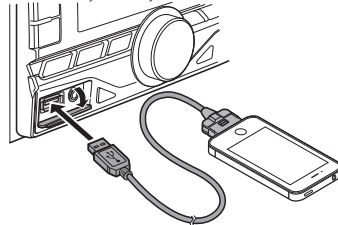

Pandora® internet radio

Basic operation

Thumbs up

DPX-U5130BT

Press and hold the [1] button.

DPX-U5130

Press and hold the [▲] button.

Thumbs down

DPX-U5130BT

Press and hold the [2] button.

DPX-U5130

Press and hold the [▼] button.

Song skip

Press the [▶▶].

Pause and play a song

Press the [▶||] button.

Station search

You can select the station you want to listen to from your station list.

1 Press the [Q] button.

"SEARCH" appears and enter the Station List mode.

2 Use the [Control knob] to select a sort type.

For how to use the [Control knob], refer to <How to select the item> (page 9).

"A-Z": Stations are displayed in alphabetical order.

"By Date": Stations are displayed in date order.

3 Use the [Control knob] to select a station.

New station registration

You can search for a desired station. You can register the displayed station as a new station in your station list.

1 Press and hold the [Q] button.

"NEW STATION" appears and enter the New station registration.

2 Use the [Control knob] select a search method.

For how to use the [Control knob], refer to <How to select the item> (page 9).

- "FROM ARTIST": Searches for a song by the name of the artist you are listening to.
- "FROM TRACK": Searches for a song by the name of the track you are listening to.

When you select a search method, a new station name is created.

3 Use the [Control knob] to select a station.

The broadcast from the selected station is received and the station is registered in the station list.

Station preset memory

You can store a station in the memory.

1 Press the [◀◀] or [▶▶] button to select the station.

2 Press and hold the button ([3] to [5]) to which you want to assign the selected station.

"STORED" appears and the channel is registered.

Preset tuning

Recalling a channel from the memory.

Press the button ([3] to [5]) corresponding to the station you want to listen to.

Pandora source control

You can turn on/off the Pandora source.

1 Press and hold the [AUDIO] button.

Enter the Function setting mode.

2 Use the [Control knob] to select "INITIAL SET" > "PANDORA SRC".

For how to use the [Control knob], refer to <How to select the item> (page 9).

3 Use the [Control knob] to select a Pandora source control method.

"ON": Turns on the Pandora source.

"OFF": Turns off the Pandora source.

Exit the Function setting mode

Press and hold the [↩] button.

Aha Radio (Function of iPhone®/ Android)

Requirements Aha™

Requirements for listening to Aha™ are as follows:

- In the application on your device, log in and create a free account with Aha.
- Internet connection by 3G, LTE, EDGE, or WiFi.

iPhone or iPod touch

- Use an Apple iPhone or iPod touch running iOS4 or later.
- Search for “Aha” in the Apple iTunes App Store to find and install the most current version of the Aha™ application on your device.
- iPhone/ iPod touch connected to this unit with a KCA-iP102.

Android™

- Use Android OS 2.2 or later.
- Download the Aha™ application to your smartphone from the Google play.
- Bluetooth must be built in and the following profiles must be supported.
 - SPP (Serial Port Profile)
 - A2DP (Advanced Audio Distribution Profile)

Notes

- Because Aha™ is a third-party service, the specifications are subject to change without prior notice. Accordingly, compatibility may be impaired or some or all of the services may become unavailable.
- Some Aha™ functionality cannot be operated from this unit.

Listening to the Aha Radio

Android or BlackBerry (DPX-U5130BT only)

- You need to register your cell-phone before using it with this unit. See <Registering a Bluetooth device> (page 30).
- Disconnect the iPhone or iPod touch.

1 Connect the Android/BlackBerry smartphone via Bluetooth.

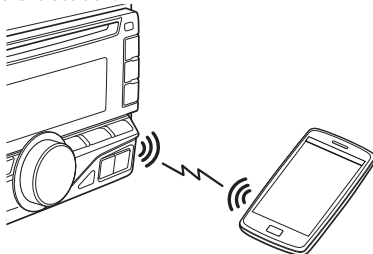

Speakers from which audio is output change depending on the Bluetooth setting “BT HF/AUDIO”. The default is Front. See <Bluetooth detail setting> (page 37).

2 Open the Aha Radio application on your device.

3 Press the [SRC] button to select an Aha Radio (“AHA”) source.

Refer to <Source selection> (page 10).

iPhone or iPod touch

1 Open the Aha Radio application on your device.

2 Open the cover.

3 Connect the iPod to the USB terminal using the KCA-iP102 connector (optional accessory).

4 Press the [SRC] button to select an Aha Radio (“AHA”) source.

Refer to <Source selection> (page 10).

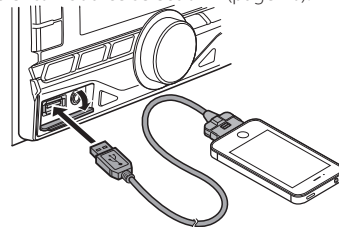

Basic operations

Pause and play a content

Press the [▶||] button.

Selecting a content

Press the [◀◀] or [▶▶] button.

Forward 30 seconds a content

Press and hold the [▶▶|] button.

Backward 15 seconds a content

Press and hold the [◀◀] button.

“Likes” current content

Press the [1] button.

To unvote, press the button again.

“Dislikes” current content

Press the [2] button.

To unvote, press the button again.

Station search

You can select the station you want to listen to from your station list.

1 Press the [Q] button.

“SEARCH” appears and enter the Station List mode.

2 Use the [Control knob] to select a station.

For how to use the [Control knob], refer to <How to select the item> (page 9).

3 Use the [Control knob] to select a content.

Calling a number in the content

You can call the phone number obtained from the content from a smartphone connected to this unit via Bluetooth.

1 Press the [3] button.

“MAKE A CALL” appears.

2 Press the [Control knob] to make a call.

“CALL” appears.

Canceling the confirmative display

Press and hold the [↵] button.

Disconnecting a call

Press the [📞] button.

Listen to the CD/ Audio file

Playing music

Playing a disc

Insert a disc in the Disc slot.
When it is inserted, the source is switched automatically and playback starts.

Playing a USB device

Connect a USB device to the USB terminal using the CA-U1EX connector (500 mA Max.: optional accessory).

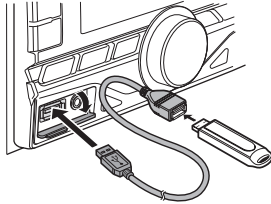

When it is connected, the source is switched automatically and playback starts.

Selecting an audio file folder

DPX-U5130BT

Press the [1] or [2] button.

DPX-U5130

Press the [▲] or [▼] button.

Selecting a song (track or file)

Press the [◀◀] or [▶▶] button.

Fast-forwarding or fast-backwarding a song (track or file)

Press and hold the [◀◀] or [▶▶] button.

Pause and play a song (track or file)

Press the [⏸] button.

Removing disc

Press the [▲] button.

Removing USB device

Press the [SRC] button to switch the source to a device other than USB, and then remove the USB device.
Data contained in the USB device may be damaged if you remove it when it is used as the active source.

Music search

You can select the music you want to listen to from the device or media being played now.

1 Press the [Q] button.

“SEARCH” appears and enters the Music search mode.

2 Search for music

Audio file

Operation type	Operation
Selecting folders/files	Turn the [Control knob].
Determining selection	Press the [Control knob].
Skip Search (Music Editor media)	Press the [◀◀] or [▶▶]./ Press and hold the [◀◀] or [▶▶].
Returning to previous folder	Press the [↶] button.
Returning to root folder	Press the [5].
Cancellation of Music search mode	Press and hold the [↶] button.

♪ indicator: Audio file

□ indicator: Folder

CD source

Operation type	Operation
Selecting track	Turn the [Control knob].
Determining selection	Press the [Control knob].
Returning to first track	Press the [5].
Cancellation of Music search mode	Press and hold the [↶] button.

Skip search ratio setting

You can change the ratio of skip performed as mentioned in <Skip Search (Music Editor media)> (page 20).

1 Select the USB source.

Refer to <Source selection> (page 10).

2 Press and hold the [AUDIO] button.

Enter the Function setting mode.

3 Use the [Control knob] to select “SETTINGS” > “SKIP SEARCH”.

For how to use the [Control knob], refer to <How to select the item> (page 9).

4 Use the [Control knob] to select a ratio.

The previous item appears.

Exit the Function setting mode

Press and hold the [↶] button.

Play function

Repeat play

Press the [4] button.

Switches between Track Repeat ("TRACK REPEAT") and OFF ("REPEAT OFF") when pressed while playing a CD.

Switches between File Repeat ("FILE REPEAT"), Folder Repeat ("FOLDER REPEAT"), and OFF ("REPEAT OFF") when pressed while playing an Audio file.

Random play

Press the [3] button.

Randomly plays the music in the disc or folder.

When Random Play is turned on, "DISC RANDOM"/ "FOLDER RANDOM" appears.

Press this button again cancels the Random play.

All Random play

Press and hold the [3] button.

All songs in the disc/USB are played at random.

Pressing the button toggles the setting between All random play on ("ALL RANDOM") and off ("RANDOM OFF").

Press this button again cancels the All Random play.

Direct music search

(Function of remote control)

You can search for music by entering the track number.

1 Press the [DIRECT] button on the remote control.

"--" appears and enter the Direct Music search mode.

2 Press the number buttons on the remote control to enter the music number.

3 Press the [ENT] button on the remote control.

Canceling the Direct music search mode

Press the [↩] button on the remote control.

About the Audio file

• Playable Audio files

AAC-LC (.m4a), MP3 (.mp3), WMA (.wma), WAV of USB device (.wav)

• Playable disc media

CD-R/RW/ROM

• Playable disc file formats

ISO 9660 Level 1/2, Joliet, Long file name.

• Playable USB devices

USB mass storage class

• Playable USB device file systems

FAT12, FAT16, FAT32

Even if the audio files comply with the standards listed above, playback may be impossible depending on the type or condition of the medium or device.

• Playback order of the Audio files

In the example of folder/file tree shown below, files are played in the order of number from (1) to (6).

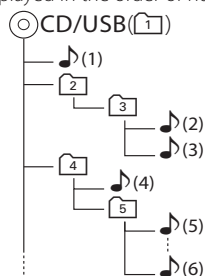

[]: folder

♪: Audio file

For the online manual describing audio files, visit www.kenwood.com/cs/ce/audiofile/. In this online manual, detailed information and notes which are not provided in this manual are provided. Make sure to read through the online manual as well.

What is a USB device?

- In this manual, the term "USB device" indicates a flash memory or digital audio player which has a USB terminal.

Listen to the CD/ Audio file

About the USB device

- When the USB device is connected to this unit, it is charged when this unit is powered.
- Install the USB device in the place where it will not prevent you from driving your vehicle properly.
- You cannot connect a USB device via a USB hub or multi card reader.
- Save backups of the audio files used with this unit. The files can be erased depending on the operating condition of the USB device.

We shall not be liable for any damage arising out of erasure of the stored data.

- No USB device comes with this unit. You need to purchase a commercially available USB device.
- When connecting the USB device, use of the CA-U1EX (option) is recommended.
- Normal playback is not guaranteed when a cable other than the USB compatible cable is used. Connecting a cable whose total length is longer than 4 m can result in abnormal playback.

About “KENWOOD Music Editor Light” and “KENWOOD Music Control”

- This unit supports the PC application “KENWOOD Music Editor Light” (hereinafter “KME-Light”), and Android™ application “KENWOOD Music Control” (hereinafter “KMC”).
- When you use the audio file with database information added by the “KENWOOD Music Editor Light” or “KENWOOD Music Control”, you can search for a file by title, album or artist name using Music Search.
- “KENWOOD Music Editor Light” and “KENWOOD Music Control” are available from the following web site: www.kenwood.com/cs/ce/

About the discs used with this unit

- This unit can only play the CDs with .
- The following discs cannot be used:
 - A disc that is not round
 - A disc with coloring on the recording surface or a disc that is dirty
 - A recordable/rewritable disc that has not been finalized (For the finalization process, refer to the instruction manual that came with your disc writing software or your disc recorder.)
 - An 8 cm (3 inch) disc (An attempt to insert using an adapter can cause malfunction.)

Handling discs

- Do not touch the recording surface of the disc.
- Do not stick tape etc. on the disc, or use a disc with tape stuck on it.
- Do not use any accessories for the disc.
- Do not use any solvents to clean discs. Use a dry silicon or soft cloth.
- Clean the disc by moving the cloth outward from the center of the disc.
- When removing a disc from this unit, pull it out horizontally.
- If the center hole or outside rim of a disc has burrs, remove them before inserting a disc.

Listen to the tuner

Listening to the radio

Selecting a tuner source

Press the [SRC] button to select a "TUNER".

Selecting a band

Press the [Q] button.

Pressing the button switches the receiving band (FM1, FM2, FM3, MW, SW1, SW2).

Selecting a station

Press the [◀◀] or [▶▶] button.

The tuning mode can be changed. Refer to <Tuner setting> (page 23).

Station preset memory

You can store a station in the memory.

1 Press the [◀◀] or [▶▶] button to select the channel.

2 Press and hold the button ([1] to [6]) to which you want to assign the selected station.
"STORED" appears and the station is registered.

About the Mix station preset mode

- In this mode, different bands and tuner sources can be saved in the same preset layer, which allows you to recall the desired station without switching between bands or tuner sources.

Auto memory

You can register 6 (FM)/ 6 (AM) stations with good reception automatically.

1 Select the Tuner source.

Refer to <Source selection> (page 10).

2 Press and hold the [AUDIO] button.

Enter the Function setting mode.

3 Use the [Control knob] to select "SETTINGS" > "AUTO MEMORY".

For how to use the [Control knob], refer to <How to select the item> (page 9).

4 Use the [Control knob] to select "YES".

When 6 (FM)/ 6 (AM) stations that can be received are stored in the memory, the process in this mode is completed.

Preset tuning

Recalling a station from the memory.

1 Press the [Q] button to select a band.

2 Press the button ([1] to [6]) corresponding to the station you want to listen to.

Tuner setting

You can set up the tuner.

1 Select the Tuner source.

Refer to <Source selection> (page 10).

2 Press and hold the [AUDIO] button.

Enter the Function setting mode.

3 Use the [Control knob] to select "SETTINGS".

For how to use the [Control knob], refer to <How to select the item> (page 9).

4 Use the [Control knob] to select a Tuner setting item

Display	Description
"LOCAL SEEK"	Only stations whose reception is good are searched in auto seek tuning. (FM only) "ON" / "OFF"
"SEEK MODE"	Sets the tuning mode. "AUTO1": Automatic search for a station. "AUTO2": Search in order of the stations in the preset memory. "MANUAL": Normal manual tuning.
"MONO SET"	You can reduce the noise when stereo broadcasts are received as monaural. (FM only) "ON" / "OFF"

(_ : Factory setting)

5 Use the [Control knob] to select a setting.

The previous item appears.

Exit the Function setting mode.

Press and hold the [↵] button.

Listen to the tuner

Direct access tuning

(Function of remote control)

You can search for a station directly by entering frequency.

1 Press the [DIRECT] button on the remote control.

“— — —” appears and enter the Direct access tuning mode.

2 Press the number buttons on the remote control to enter the frequency.

Example:

Desired frequency	Press the following buttons
92.1 MHz (FM)	[9], [2], [1]
810 kHz (AM)	[8], [1], [0]

3 Press the [ENT] button on the remote control.

Canceling Direct access tuning mode

Press the [] button on the remote control.

Frequency Step Setting

Changing the tuning frequency step.

The original setting is FM band 50 kHz, and AM band 9 kHz.

1 Press and hold the [SRC] button to turn the power OFF.

2 While pressing the [1] and [5] buttons, press the [SRC] button to switch the frequency step.

Release your fingers from the button after the display appears.

The frequency step changes to FM band 200 kHz, and AM band 10 kHz.

Notes

- When the same operation is repeated, the frequency step returns to the original setting.
- When the frequency step is changed, the frequencies in the memory are deleted.

Listen to the AUX

Start listening

- 1 Connect a portable audio player with 3.5 mm stereo mini plug audio cable (commercially available).**

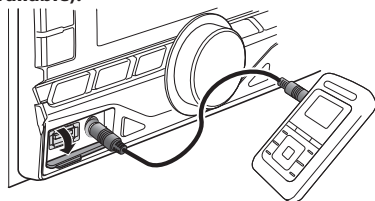

- 2 Select the AUX source.**
Refer to <Source selection> (page 10).
- 3 Turn on the portable audio player and start playback.**

Auxiliary input display setting

You can set the display when switched the AUX source.

- 1 Select the AUX source.**
Refer to <Source selection> (page 10).
- 2 Press and hold the [AUDIO] button.**
Enter the Function setting mode.
- 3 Use the [Control knob] to select "SETTINGS" > "AUX NAME SET".**
For how to use the [Control knob], refer to <How to select the item> (page 9).
- 4 Use the [Control knob] to select a display ("AUX", "DVD", "PORTABLE", "GAME", "VIDEO", or "TV").**

Exit the Function setting mode.

Press and hold the [↵] button.

Display settings

Illumination color selection

You can select the illumination color of the panel.

1 Press and hold the [AUDIO] button.

Enter the Function setting mode.

2 Use the [Control knob] to select "SETTINGS" > "DISP & KEY" > "COLOR SELECT".

For how to use the [Control knob], refer to <How to select the item> (page 9).

3 Use the [Control knob] to select a illumination part.

Display	Part
"ALL"	All
"DISP"	Display
"KEY"	Button

4 Use the [Control knob] to select a color ("VARIABLE SCAN"/"COLOR01" — "COLOR24").

Exit the Function setting mode.

Press and hold the [↵] button.

Adjusting the Illumination color

You can adjust the illumination color of the panel.

1 Select the illumination color you want to adjust.

Select from among "COLOR01" to "COLOR24" with reference to <Illumination color selection> (page 26).

2 Press and hold the [Control knob].

The RGB value of the selected illumination color appears and enters the Detail color adjustment mode.

3 Set the color.

Operation type	Operation
To select the color to adjust (Red, Green, or Blue)	Press the [◀◀] or [▶▶].
To adjust color (Range: 0 – 9)	Turn the [Control knob].
Determination of the adjusted color.	Press the [Control knob].

The color you created can be called by selecting "USER".

Exit the Function setting mode.

Press and hold the [↵] button.

Display & Illumination setting

You can set the display and illumination.

1 Press and hold the [AUDIO] button.

Enter the Function setting mode.

2 Use the [Control knob] to select "SETTINGS" > "DISP & KEY".

For how to use the [Control knob], refer to <How to select the item> (page 9).

3 Use the [Control knob] to select a Display & Illumination setting item.

Display	Description
"DISP DIMMER"	Dims the display part in conjunction with the Light switch of the vehicle. "DIM OFF": Does not dim the display. "DIM AUTO": Dims the display in conjunction with the Light switch of the vehicle. "DIM MANUAL1": Dims the display constantly. "DIM MANUAL2": Dims the display darker than that in the Manual1 mode.
"TEXT SCROLL"	Sets the method of scrolling to view hidden texts. "SCROLL AUTO": Scrolls. "SCROLL ONCE": Scrolls once. "SCROLL OFF": Does not scroll.
"DISP OFF MODE"	Sets the clock and button illumination when "DISP OFF MODE" is selected as described in <Text Display Selection> (page 27).
"CLOCK"	"CLOCK ON": Displays the clock. "CLOCK OFF": Dims the clock.
"KEY ILLUMI"	"KEY ON": Turns on the button illumination. "KEY OFF": Dims the button illumination.
"ILLUMI DIMMER"	Reduces the key illumination brightness. "DIM OFF": Does not dim the illumination. "DIM AUTO": Dims the illumination in conjunction with the Light switch of the vehicle. "DIM MANUAL1": Dims the illumination constantly. "DIM MANUAL2": Dims the illumination darker than that in the Manual1 mode.
"BT DVC STATUS"	You can display the connection status, signal strength, and battery level. HF-CON : Connection status for cell-phone. (1/: One cell-phone is connected, 1/2: Two cell-phones are connected, NO: No cell-phone is connected.) AD-CON : Connection status for BT Audio. (YES: Connected, NO: Not connected) BATT : Battery level of cell-phone. SIGNAL : Signal strength of cell-phone. (Function of DPX-U5130BT)

(_ : Factory setting)

4 Use the [Control knob] to select a setting.

The previous item appears.

Exit the Function setting mode.

Press and hold the [↵] button.

Text Display Selection

You can change the information displayed on each of the following sources:

1 Press the [DISP].

On Audio file/ iPod source

Information	Display
Title and Artist name	"TITLE/ARTIST"
Album and Artist name	"ALBUM/ARTIST"
Folder name	"FOLDER NAME"
File name	"FILE NAME"
Play time	"P-TIME"
Display off	"DISP OFF MODE"

On Pandora source

Information	Display
Station name	"STATION NAME"
Title and Artist name	"TITLE/ARTIST"
Album and Artist name	"ALBUM/ARTIST"
Play time	"P-TIME"
Display off	"DISP OFF MODE"

DPX-U5130BT

On Aha Radio source

Information	Display
Content Provider	"PROVIDER"
Content information 1	"CONTENT INFO1"
Content information 2	"CONTENT INFO2"
Content rating information	"CONTENT RATE"
Station name	"STATION NAME"
Display off	"DISP OFF MODE"

On CD source

Information	Display
Disc title	"DISC TITLE"
Track title	"TRACK TITLE"
Play time	"P-TIME"
Display off	"DISP OFF MODE"

On Tuner source

Information	Display
Frequency	"FREQUENCY"
Display off	"DISP OFF MODE"

DPX-U5130BT

On Bluetooth audio source

Information	Display
Title and Artist name	"TITLE/ARTIST"
Album and Artist name	"ALBUM/ARTIST"
Play time	"P-TIME"
Display off	"DISP OFF MODE"

On Standby/ Auxiliary input source

Information	Display
Source name	"SOURCE NAME"
Display off	"DISP OFF MODE"

Text display notes

- When you select the Display off mode, the display setting of each source will be changed to the Display off.
- If the selected display item does not have any information, alternative information appears.
- If you select "FOLDER NAME" while playing music on the iPod, names will be displayed depending on the currently selected browsing items.
- If you select the APP & iPod Control mode while playing music on the iPod, "APP&iPod MODE" appears.
- If all characters cannot be displayed while music is played on the iPod, the file number in the list appears.

Information	Display
Music title	"TITLE****"
Folder name	"FOLDER****"
File name	"FILE****"

Text scroll

Press and hold the [DISP].

The displayed text scrolls.

General settings

Muting the audio upon reception of a phone call

Function of DPX-U5130

The audio system automatically mutes when it receives an incoming call.

When a call comes in

"CALL" appears.

The audio system pauses.

Listening to the audio during a call

Press the [SRC] button.

The "CALL" display disappears and the audio system comes back ON.

When the call ends

Hang up the phone.

The "CALL" display disappears and the audio system comes back ON.

To use this function

- To use the TEL Mute feature, you need to hook up the MUTE wire to your telephone using a commercial telephone accessory. Refer to <Connecting Wires to Terminals> (page 44).

Demonstration mode setting

You can turn on/off the demonstration mode.

1 Press and hold the [AUDIO] button.

Enter the Function setting mode.

2 Use the [Control knob] to select "DEMO MODE".

For how to use the [Control knob], refer to <How to select the item> (page 9).

3 Use the [Control knob] to select a setting ("ON" or "OFF").

Exit the Function setting mode.

Press and hold the [↵] button.

Initial settings

You can configure initial settings of this unit.

1 Select the Standby source.

Refer to <Source selection> (page 10).

2 Press and hold the [AUDIO] button.

Enter the Function setting mode.

3 Use the [Control knob] to select "INITIAL SET".

For how to use the [Control knob], refer to <How to select the item> (page 9).

4 Use the [Control knob] to select an Initial setting item.

Display	Description
"PRESET TYPE"	Sets the Tuner preset type. "TYPE NORMAL" : 1 station can be assigned to 1 preset button in each of 4 bands (FM1, FM2, FM3, and AM), i.e., a total of 24 stations (6 stations x 4 bands) can be preset. "TYPE MIX" : A total of 6 stations can be assigned to a total of 6 preset buttons regardless of band (FM1, FM2, FM3, and AM). You can recall a preset station without switching between bands.
"KEY BEEP"	Setting the operation check sound (beep sound) ON/OFF. "ON" / "OFF"
"PANDORA SRC"	Sets whether to display Pandora during source selection. "ON" / "OFF"
"AHA SRC"	Sets whether to display aha during source selection. "ON" / "OFF" (Function of DPX-U5130BT)
"BUILT-IN AUX"	Sets whether to display AUX during source selection. "ON" / "OFF"
"CD READ"	Sets the method for reading CD. When unable to play a special format CD, set this setting to "2" to force playing. Note that some music CDs may be unplayable even when set to "2". In addition, audio files cannot be played when set to "2". Normally, keep this set to "1". 1 : Automatically distinguishes between the audio file disc and music CD when playing a disc. 2 : Forces playing as a music CD.
"SWITCH PREOUT"	Switches the preout between rear output and subwoofer output. "REAR" : Rear output "SUB-W" : Subwoofer output (Function of DPX-U5130)

"SP SELECT"	Sets the speaker type so that the System Q value is optimal. "OFF" : OFF "5/4" : For 5 & 4 in. speaker "6*9/6" : For 6 & 6x9 in. speaker "O.E.M." : For the OEM speaker
"F/W UPDATE"	Upgrades the firmware. When the firmware version appears, press [Control knob]. Selecting "YES" and then pressing the [Control knob] starts upgrading the firmware. For how to update the firmware, access our web site. http://www.kenwood.com/cs/ce/

(_ : Factory setting)

5 Use the [Control knob] to select a setting.

The previous item appears.

Exit the Function setting mode.

Press and hold the [↵] button.

Registering a Bluetooth (Function of DPX-U5130BT)

About the Bluetooth module

This unit conforms to the following Bluetooth specifications:

Version	Bluetooth Ver.2.1+EDR Certified
Profile	HFP (Hands Free Profile) SPP (Serial Port Profile) PBAP (Phonebook Access Profile) OPP (Object Push Profile) A2DP (Advanced Audio Distribution Profile) AVRCP (Audio/Video Remote Control Profile)

For the cell-phones verified for compatibility, access the following URL:

<http://www.kenwood.com/cs/ce/bt/>

Notes

- The units supporting the Bluetooth function have been certified for conformity with the Bluetooth Standard following the procedure prescribed by Bluetooth SIG. However, it may be impossible for such units to communicate with your cell-phone depending on its type.
- HFP is a profile used to make a hands-free call.
- OPP is a profile used to transfer data such as a phone book between units.

Registering a Bluetooth device

You can register your Bluetooth device in this unit.

1 Start registering a unit by operating the Bluetooth device.

By operating the Bluetooth device, register the hands-free unit or audio unit (pairing).

Select "DPX-U51**BT" (for DPX-U5130BT) from the list of found units.

2 If "PAIRING PASS ***** (Bluetooth device name) PRESS VOLUME KNOB" appears, proceed to step 4.

3 Input the PIN code ("0000") in the Bluetooth device.

Check that registration is complete on the Bluetooth device. PIN code is set to "0000" as the default. You can change this code.

See <Registering the PIN code> (page 36)

"PAIRING PASS ***** (Bluetooth device name) PRESS VOLUME KNOB" appears.

4 Press the [Control knob].

Pairing starts. When it is completed, "PAIRING OK" appears.

Bluetooth module that can be used with this unit

- For details on the Bluetooth cell-phone with the hands-free function, see <About the Bluetooth module> (page 30).

About automatic connection of the iPod touch or iPhone through Bluetooth

- This unit is compatible with an Apple Auto Pairing function. Connecting the iPod touch or iPhone to this unit with USB cable will automatically register it as a Bluetooth device. See <"AUTO PAIRING"> (page 37).
 1. The Bluetooth function of the iPod touch or iPhone is turned on first.
 2. Connect an iPod touch or iPhone to the USB terminal.
 3. Press the volume knob to pair once you have confirmed the passcode.

When registration is impossible

- If there are 5 Bluetooth devices registered, you cannot register a new Bluetooth device.
- When any error code appears while the pairing is in progress, refer to <Error messages> (page 41).

When SMS is received

- When the connected Bluetooth device receives SMS, "SMS RECEIVE" is displayed on this unit.

Selecting the Bluetooth device you wish to connect

When two or more Bluetooth devices have already been registered, you need to select the Bluetooth device you wish to use.

1 Press the [BT] button.

"BT MODE" appears and enter the Bluetooth mode.

2 Use the [Control knob] to select "SETTINGS" > "PAIRING" > "PHONE SELECT" (to select the cell-phone) or "AUDIO SELECT" (to select the audio player).

For how to use the [Control knob], refer to <How to select the item> (page 9).

"(name)" appears.

3 Use the [Control knob] to select an Bluetooth device.

"*(name)" or '-(name)' appears.

"*": The selected Bluetooth device is busy.

"-": The selected Bluetooth device is on standby.

" " (blank): The Bluetooth device is deselected.

Exit the Bluetooth mode.

Press the [BT] button.

When no device can be selected

- If a cell-phone is already selected, deselect it, and then select a different one.
- If you cannot select a device using the audio player, connect the device with the audio player.

Deleting a registered Bluetooth device

You can delete a registered Bluetooth device.

1 Press the [↵] button.

"BT MODE" appears and enter the Bluetooth mode.

2 Use the [Control knob] to select "SETTINGS" > "PAIRING" > "DEVICE DELETE".

For how to use the [Control knob], refer to <How to select the item> (page 9).

"(name)" appears.

3 Use the [Control knob] to select an Bluetooth device.

4 Use the [Control knob] to select "YES".

"COMPLETED" appears.

Exit the Bluetooth mode.

Press the [↵] button.

When a registered device is deleted

- When a registered cell-phone is deleted, its phone Book, and log are also deleted.

Bluetooth device registration test

You can check whether a Bluetooth device can be registered by operating this unit.

1 Press the [↵] button.

"BT MODE" appears and enter the Bluetooth mode.

2 Use the [Control knob] to select "BT TEST MODE".

For how to use the [Control knob], refer to <How to select the item> (page 9).

"PLEASE PAIR YOUR PHONE" appears.

3 By operating the Bluetooth device, register the hands-free unit or audio unit (pairing).

Select "DPX-U51**BT" (for DPX-U5130BT) from the list of found units.

4 If "(Bluetooth device name)" appears, proceed to step 6.

5 Input the PIN code ("0000") in the Bluetooth device.

6 Use the [Control knob] to select an Bluetooth device.

When pairing is completed successfully, a connection test starts automatically.

When the connection test is completed, test results are displayed on a function basis ("OK": Enabled; "NG": Disabled).

Display	Description
"PAIRING"	Registration in this unit
"HF CNT"	Hands-free phoning
"AUD CNT"	Audio playback
"PB DL"	Phone Book downloading

7 Press the [Control knob].

Exit the test mode.

Hands-free phoning (Function of DPX-U5130BT)

Receiving a call

You can answer a phone call

Press the [📞] button.

The following operations disconnect the line

- Inserting a CD.
- Connecting a USB device.

Rejecting an incoming call

Press the [SRC] button.

Calling a number in the phone book

1 Press the [📞] button.

2 Search for a name in the phone book.

Operation type	Operation
Selection of name list	Turn the [Control knob].
Switching to number list	Press the [Control knob].

3 Search for a number in the phone book.

Operation type	Operation
Selection of number list	Turn the [Control knob].
Switching to name list	Press the [↵].

4 Press the [Control knob].

Make a call.

When there is no phone book

- If the phone book has not yet been downloaded automatically, download it according to <Downloading the phone book> (page 36).

Display of phone book

- During search, a non-accent character such as “u” is searched for instead of an accent character such as “ü”.

Alphabet search

You can search for a name in the phone book by the alphabet.

1 Press the [📞] button.

1 Press the [Q] button.

Enter the Alphabet search mode and “<ABCDEFGHUIJK>” appears.

2 Search for a name in the phone book.

Operation type	Operation
Selection of initial	Turn the [Control knob].
Page feeding of alphabetical list	Press the [◀] or [▶].
Determine the initial	Press the [Control knob].

3 Use the [Control knob] to select a name.

4 Search for a number in the phone book.

Operation type	Operation
Selection of number list	Turn the [Control knob].
Switching to name list	Press the [↵].

5 Press the [Control knob].

Make a call.

Canceling the Alphabet search mode

Press and hold the [↵] button.

Dialing a number

1 Press the [📞] button.

“BT MODE” appears and enter the Bluetooth mode.

2 Use the [Control knob] to select “NUMBER DIAL”.

For how to use the [Control knob], refer to <How to select the item> (page 9).

3 Enter a phone number.

Operation type	Operation
Selection of number	Turn the [Control knob].
Selection of digit	Press the [◀] or [▶].

4 Press the [Control knob].

Make a call.

Number of digits that can be input

- You can input a maximum of 32 digits.

Calling a number in the call log

1 Press the [📶] button.

"BT MODE" appears and enter the Bluetooth mode.

2 Use the [Control knob] to select "CALL HISTORY".

For how to use the [Control knob], refer to <How to select the item> (page 9).

3 Turn the [Control knob] to select a name and phone number.

I : Incoming calls

O : Outgoing calls

M : Missed calls

4 Press the [Control knob].

Make a call.

Speed dialing (Preset dial)

1 Press the [📶] button.

"BT MODE" appears and enter the Bluetooth mode.

2 Press number button ([1] to [6]).

3 Press the [Control knob].

Make a call.

Registering a dial number

- You need to register the preset dial number. Refer to <Registering in the preset dial number list> (page 33).

Registering in the preset dial number list

1 Press the [📶] button.

"BT MODE" appears and enter the Bluetooth mode.

2 Enter the phone number you wish to register

Enter the phone number with reference to the following:

<Calling a number in the phone book> (page 32)

<Dialing a number> (page 32)

<Calling a number in the call log> (page 33)

3 Press and hold number button ([1] to [6]).

During a call

Disconnecting a call

Press the [SRC] button.

Switching to the Private mode

Press the [▶II] button.

Pressing this knob each time switches between the private talk mode ("PV TALK") and hands-free talk mode ("HF TALK").

When the previous source is restored in the Private mode

- Depending on the type of your cell-phone, switching to the private talk mode may select the source that was used before commencing the hands-free connection. If this happens, the source cannot be switched back to the hands-free talk mode by operating this unit. Operate your cell-phone to return to the hands-free talk mode.

Adjusting the voice volume during a call

Turn the [Control knob].

Hands-free phoning

Switching between Two Connected Cell-phones

When two Bluetooth devices are connected, you can assign the Bluetooth device to be used in priority to the other Bluetooth device.

When selecting the priority device using the button

1 Press the [↵] button.
"BT MODE" appears and enter the Bluetooth mode.

2 Press and hold [↵] button.
The device given priority is changed.

When selecting the priority device from the menu

1 Press the [↵] button.
"BT MODE" appears and enter the Bluetooth mode.

2 Use the [Control knob] to select "DVC PRIORITY".
For how to use the [Control knob], refer to <How to select the item> (page 9).

3 Turn the [Control knob] to select a "MAIN" or "SUB".

4 Press the [Control knob].
When Sub is selected, the device given priority is changed.

Exit the Bluetooth mode.

Press the [↵] button.

Notes

- You cannot switch between the connected cell-phones during downloading of the Phone Book.
- Only the main cell-phone from which you can make a call.
- Both the main and sub cell-phones can receive an incoming call.
- If the other cell-phone receives an incoming call while you are talking on the active cell-phone, you must finish the current call to answer the incoming call to the other cell-phone.
- If the main cell-phone is disconnected when it is taken out of the vehicle, the sub cell-phone becomes the main cell-phone if it is held connected. When the disconnected cell-phone is brought back into the vehicle, it is reconnected as the sub cell-phone.

Clearing the disconnection message

Press the [↵] button.
"HF DISCONNECT" disappears.

Making a call by voice dialing

You can make a voice call using the voice recognition function of the cell-phone.

1 Press and hold the [↵] button to start voice recognize.

"VOICE CONTROL" appears.

2 Pronounce the name registered in the cell-phone.

Make a call.

Canceling the voice recognize

Press and hold the [↵] button.

About voice recognition

- If "NO SUPPORT" appears, your cell-phone does not support the voice recognition function.
- If "N/A VOICE TAG" appears, your cell-phone cannot start voice recognition.
- If your voice cannot be recognized, a message appears. Press and hold the volume knob to terminate voice recognition. Retry it again from the beginning.
- Audio sound is not output during voice recognition.

Display of phone number types (categories)

The category items in the phone book are displayed as follows:

Display	Information
HOME	Home
MOBILE	Mobile
OFFICE	Office
GENERAL	General
OTHERS	Other

Bluetooth audio (Function of DPX-U5130BT)

Before use

- You need to register your Bluetooth audio player before using it with this unit. For more details, see <Registering a Bluetooth device> (page 30).
- You need to select the Bluetooth audio player you wish to connect. Refer to <Selecting the Bluetooth device you wish to connect> (page 30).

Basic operations

Selecting a Bluetooth audio source

Select the Bluetooth audio source.

Refer to <Source selection> (page 10).

Pause and play a song

Press the [▶II] button.

Selecting a song

Press the [◀◀] or [▶▶] button.

Fast-forwarding or fast-backwarding a song

Press and hold the [◀◀] or [▶▶] button.

Selecting an audio file folder

Press the [1] or [2] button.

Preparation for using a Bluetooth audio player

- All or some of the operations above cannot be performed if the Bluetooth audio player is not ready for remote control.
- Switching between Bluetooth audio sources does not start or stop playback automatically. Perform the operation for starting or stopping playback.
- Some audio players cannot be controlled remotely or reconnected after Bluetooth disconnection. Operate the main unit of the audio player to connect a Bluetooth device.

Play function

Random play

Press the [3] button.

Switches between Folder Random ("FOLDER RANDOM"), All Random ("ALL RANDOM"), and OFF ("RANDOM OFF").

Repeat play

Press the [4] button.

Switches between File Repeat ("FILE REPEAT"), All Repeat ("ALL REPEAT"), and OFF ("REPEAT OFF").

Functions that can be used

- The available playback functions differ depending on the type of the connected Bluetooth audio player.

Bluetooth settings (Function of DPX-U5130BT)

Registering the PIN code

By operating the Bluetooth device, specify the PIN code necessary for registering this unit.

1 Press the [F] button.

"BT MODE" appears and enter the Bluetooth mode.

2 Use the [Control knob] to select "SETTINGS" > "DETAILED SET" > "PIN CODE EDIT".

For how to use the [Control knob], refer to <How to select the item> (page 9).

3 Input the PIN code

Operation type	Operation
Selection of numbers	Turn the [Control knob].
Movement to the next digit	Press the [▶▶].
Deletion of the last digit	Press the [◀◀].
Transmission of PIN code	Press the [Control knob].

If "COMPLETED" appears and registration is complete.

Exit the Bluetooth mode.

Press the [F] button.

Notes on PIN code input

- By default, "0000" is specified.
- A PIN code can be specified with up to eight digits.

Downloading the phone book

If the phone book is not downloaded automatically to this unit to which a cell-phone -which is not compatible with PBAP- is connected, download it in the following manner:

1 Press the [F] button.

"BT MODE" appears and enter the Bluetooth mode.

2 Use the [Control knob] to select "SETTINGS" > "TRANSFER PB".

For how to use the [Control knob], refer to <How to select the item> (page 9).

When downloading starts, "PB DL ###" appears.

Exit the Bluetooth mode.

Press the [F] button.

Maximum number of phone numbers that can be registered

- Up to 400 phone numbers can be registered for each registered cell-phone.
- Up to 32 digits can be registered for each phone number along with up to 50* characters representing a name. (* 50: Number of alphabetical characters. Fewer characters can be input depending on the type of characters.)

Cancellation of downloading

- To cancel downloading of the phone book data, operate the cell-phone.

Deleting the phone book

You can delete the phone book stored in this unit to which a cell-phone – which is not compatible with PBAP – is connected.

1 Press the [OK] button.

2 Search for a number/name in the phone book.

Operation type	Operation
Selection of name list and number list	Turn the [Control knob].
Switching to number list	Press the [Control knob].
Switching to name list	Press the [↵].

3 Press and hold the [Control knob].

4 Use the [Control knob] to select the item to be deleted.

For how to use the [Control knob], refer to <How to select the item> (page 9).

Display	Item to be deleted
"DELETE ONE"	When a name is selected, all phone numbers registered to the name are deleted. When a phone number is selected, only the selected phone number is deleted.
"DELETE ALL"	When a name is selected, all the registered phone books are deleted. When a phone number is selected, all the phone books having the name to which the selected number are deleted.

5 Use the [Control knob] to select "YES".

"COMPLETED" appears.

Displaying the firmware version

You can view the version of the firmware of this unit.

1 Press the [P] button.

"BT MODE" appears and enter the Bluetooth mode.

2 Use the [Control knob] to select "SETTINGS" > "DETAILED SET" > "BT F/W UPDATE".

For how to use the [Control knob], refer to <How to select the item> (page 9).

The firmware version appears.

Exit the Bluetooth mode.

Press the [P] button.

How to update

- For how to update the firmware, access our web site.
www.kenwood.com/cs/ce/bt/

Bluetooth detail setting

You can configure the initial settings of this unit.

1 Press the [P] button.

"BT MODE" appears and enter the Bluetooth mode.

2 Use the [Control knob] to select "SETTINGS" > "DETAILED SET".

For how to use the [Control knob], refer to <How to select the item> (page 9).

3 Use the [Control knob] to select an Bluetooth detail setting item.

Display	Description
"AUTO ANSWER"	Automatically answers a call after lapse of the preset time interval. "OFF": Does not answer the phone call automatically. "1" – "8" – "99": Automatically answers the phone call after lapse of 1 – 99 seconds.
"RECONNECT"	When set to "ON", starts re-pairing with the registered Bluetooth device automatically when it becomes unpaired. "ON" / "OFF"
"AUTO PAIRING"	When set to "ON", performs Bluetooth pairing automatically when the iPhone is connected to the USB terminal. "ON" / "OFF"
"BT HF/AUDIO"	Specifies the output speakers for hands-free voice communication and Bluetooth audio sound. "FRONT": Outputs sound from the front speakers. "ALL": Outputs sound from the front and rear speakers.
"CALL BEEP"	Sets whether to output a beep from the speaker when a call comes in. "ON": Outputs a beep. "OFF": Does not output a beep.
"MIC GAIN"	Adjusts the sensitivity of the microphone for telephone call or adjusts the voice of the caller. "-20" – "0" – "+8"
"ECHO CANCEL"	Sets the echo cancellation level. "1" – "4" – "10"

(_ : Factory setting)

4 Use the [Control knob] to select a setting.

The previous item appears.

Exit the Bluetooth mode.

Press the [P] button.

Basic operation of remote control

Before using remote control

Preparing the remote control unit

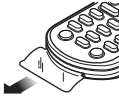

Pull the battery sheet out from the remote control unit in the direction of the arrow.

Changing the battery of the remote control unit

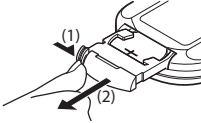

Use a commercially available button battery (CR2025). Insert the battery with the + side facing upward, following the illustration inside the case.

- (1) Keep on sliding.
- (2) Pull out.

⚠ CAUTION

- **Keep battery out of reach of children and in original package until ready to use. Dispose of used batteries promptly. If swallowed contact physician immediately.**
- **Do not leave the battery near fire or under direct sunlight. A fire, explosion or excessive heat generation may result.**
- **Do not set the remote control in hot places such as on the dashboard.**
- **The Lithium battery is in danger of explosion if replaced incorrectly. Replace only with the same or equivalent type.**

Basic operation

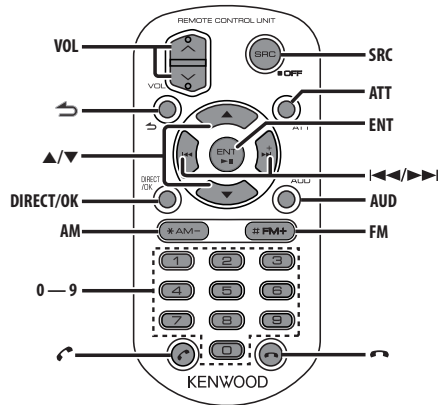

General control

- **Volume control: [VOL]**
- **Source selection: [SRC]**
Press and hold to turn off the power.
- **Volume reduction: [ATT]**
When the button is pressed again, the volume returns to the previous level.
- **Returning to previous item: [↶]**
- **Selection of item: [▲]/[▼]**
- **Determination: [ENT]**
- **Enter Audio Control mode: [AUD]**

About power on

- The remote control cannot be used to turn the power on. Press the [SRC] button on the main unit.

On Tuner source

- **Band selection: [FM]/[AM]**
- **Station selection: [◀◀]/[▶▶]**
- **Recall preset stations: [1] – [6]**

On CD/Audio file source

- **Music selection: [◀◀]/[▶▶]**
- **Folder selection: [FM]/[AM]**
- **Pause/Play: [ENT]**
- **Enter the Music search mode: [▲]/[▼]**
- **Selecting folders/files during Music search mode: [▲]/[▼]**
- **Returning to previous folder: [↶]**

On iPod source

- Enter Music search mode: [▲]/[▼]
- Selecting items during Music search mode: [▲]/[▼]
- Returning to previous item: [↶]
- Pause/Play: [ENT]

On Pandora internet radio source

- Song skip: [▶▶|]
- Pause/Play: [ENT]
- Enter the station list mode: [▲]/[▼]
 - Select item: [▲]/[▼]
 - Exit the station list mode: [↶]

On Aha source

- Selecting a content: [◀◀|]/[▶▶|]
- Pause/Play: [ENT]
- Enter the station search mode: [▲]/[▼]
 - Select item: [▲]/[▼]
 - Exit the station search mode: [↶]

Hands-free phone control

Making a call

- Enter Bluetooth mode: [📶]
- Select a dialing method: [▲]/[▼] → [ENT]
- Number dial input:
 - Input a digit: [0] – [9]
 - Input "+": [▶▶|]
 - Input "#": [FM]
 - Input "*": [AM]
 - Clear the entered phone number: [◀◀|]
- Make a call: [ENT]

Receiving a call

- Answer the call: [📶]

During a call

- End the call: [📶]

Troubleshooting guide

Setting error

Some functions of this unit may be disabled by some settings made on this unit.

- **Cannot set up display.**
 - The demonstration mode is not turned off as mentioned in <Demonstration mode setting> (page 28).
- **Cannot set up the subwoofer.**
- **Cannot set up the low pass filter.**
- **No output from the subwoofer.**
 - "SUBWOOFER SET" is not set to ON as mentioned in <Audio control> (page 11).
- **Cannot set up the subwoofer phase.**
 - "LPF SUBWOOFER" is set to "THROUGH" as mentioned in <Audio control> (page 11).

Operation/wiring error

What might seem to be a malfunction in your unit may just be the result of a slight operation error or a wiring error. Before calling for service, first check the following table for possible problems.

General

- **The key beep does not sound**
 - The Preout jack is in use.
 - The key beep cannot be output from the Preout jack.
- **Sound cannot be heard.**
 - Adjust the volume to the optimum level.
 - Check the cords and connections.

Tuner source

- **Radio reception is poor.**
 - The car antenna is not extended.
 - Pull the antenna out all the way.

Disc source

- **The specified disc does not play, but another one plays instead.**
 - The specified CD is quite dirty.
 - Clean the CD with reference to <Handling discs> (page 22).
 - The disc is severely scratched.
 - Try another disc instead.
- **Disc cannot be ejected.**
 - The unit is malfunctioning for some reason.
 - Press and hold [▲] to forcibly eject the disc. Be careful not to drop the disc when it is ejected. If this does not solve the problem, reset the unit.

Audio file source

- **The sound skips when an Audio file is being played.**
 - The media is scratched or dirty.
 - Clean the CD with reference to <Handling discs> (page 22).
 - The recording condition is bad.
 - Play the media again or use another media.

Bluetooth source

- **The hands-free talk volume is low.**
 - The hands-free talk volume can be adjusted independently.
 - Adjust it during hands-free talk. "MIC GAIN" of <Bluetooth detail setting> (page 37).
- **No beep is heard at reception of an incoming call.**
 - No beep is heard depending on the type of your cell-phone.
 - The "CALL BEEP" of <Bluetooth detail setting> (page 37) is set ON.
- **Voice is not recognized.**
 - The vehicle window is open. If the surrounding noise is large, voice cannot be recognized properly.
 - Close the vehicle windows to reduce noise.
 - Small voice. If voice is too small, it cannot be recognized properly.
 - Speak into the microphone a little more loudly and naturally.
- **The sound from the Bluetooth audio player is discontinuous.**
 - Another Bluetooth device is affecting the Bluetooth communication. Turn off another Bluetooth device. Move another Bluetooth device away from this unit.
 - Another Bluetooth device or profile is used for communication. The downloading of the Phone book disconnects the sound.

Error messages

The messages shown below indicates your system condition.

● "PROTECT" (blink)

- ❑ The speaker wire has short-circuited or touched the chassis of the vehicle, and then the protection function has been activated.
 - Lay or insulate the speaker cable properly and press the Reset button. If "PROTECT" does not disappear, consult your nearest service center.

Disc/ USB/ iPod Messages

● "COPY PRO"

- ❑ A copy-protected file is played.

● "iPod ERROR"

- ❑ Connection to the iPod has failed.
 - Remove the iPod/ iPhone and then reconnect it.
 - Reset iPod/ iPhone.

● "NA DEVICE"

- ❑ An unsupported USB device is connected.
 - Check that the connected USB device is supported. See <About the USB device> (page 22).
- ❑ Connection to the iPod has failed.
 - Check that the connected iPod is supported. See <Models of iPods/iPhones that can be connected to this unit> (page 12) for information on supported iPods.

● "NA FILE"

- ❑ An Audio file is played in a format that is not supported by this unit.

● "NO DEVICE"

- ❑ A USB device is selected as a source although no USB device is connected.
 - Change the source to any source other than the USB device. Connect an USB device, and change the source to the USB device again.

● "NO MUSIC"

- ❑ The connected USB device contains no playable audio file.
- ❑ A medium that does not have playable data has been played.

● "PLEASE EJECT"

- ❑ The unit is malfunctioning for some reason.
 - Press and hold [▲].
 - Press the reset button on the unit. If the "PLEASE EJECT" code does not disappear, consult your nearest service center.

● "READ ERROR"

- ❑ The file system of the connected USB device is broken.
 - Copy the files and folders for the USB device again. If "Read Error" is still displayed, initialize the USB device or use another USB device.

● "TOC ERROR"

- ❑ The CD is quite dirty. The CD is upside-down. The CD is scratched a lot.
- ❑ The disc is unreadable.

● "USB ERROR"

- ❑ Some trouble may have occurred to the connected USB device.
 - Remove the USB device, then cycle the power switch to ON. If the same display is repeated, use another USB device.

Bluetooth Messages

● "AUD DISCONCT"

- ❑ The unit cannot communicate with the Bluetooth audio player.

● "DEVICE FULL"

- ❑ 5 Bluetooth device have already been registered. No more Bluetooth devices are registered.

● "HF DISCONCT"

- ❑ The unit cannot communicate with the cell-phone.

● "HF ERROR 68"

- ❑ The unit cannot communicate with the cell-phone.
 - Cycle the power switch. If this message still appears, press the Reset button on the control unit.

● "HF ERROR 89"

- ❑ Update of the firmware has failed.
 - Retry update of the firmware.

● "NO DATA"

- ❑ There is no outgoing call list.
- ❑ There is no incoming call list.
- ❑ There is no missed call list.
- ❑ There is no phone book list.
- ❑ Data is not contained in the phone book.

● "NO ENTRY"

- ❑ The cell-phone has not been registered (pairing).

● "NO ACTIVE DVC"

- ❑ No cell-phone is connected.

● "NO NUMBER"

- ❑ The calling party does not notify a caller ID.
- ❑ There is no phone number data.

● "NO SUPPORT"

- ❑ Your cell-phone does not support the voice recognition function.

● "N/A VOICE TAG"

- ❑ Your cell-phone cannot start voice recognition.

● "PAIRING NG"

- ❑ Pairing error.

Troubleshooting guide

Pandora Messages

- **“ADD ERROR”**
 - ❑ Registration of the station has failed.
- **“CHECK DEVICE”**
 - ❑ Any device ready for Pandora internet radio reception is not connected to this unit.
 - ❑ Pandora application has not started, you have not signed in, or system maintenance is in progress.
- **“CONNECT ERROR”**
 - ❑ Communication is unstable.
- **“LICENSE ERROR”**
 - ❑ The Pandora® internet radio is accessed from a country to which it is not delivered.
- **“NO CONTENT”**
 - ❑ There is no receivable content.
- **“NO SKIPS”**
 - ❑ No more skips are allowed now. Retry after a while.
- **“NO STATIONS”**
 - ❑ There is no receivable station.
- **“NOT EXIST”**
 - ❑ The registered station has been deleted or the device is not the registered one.
- **“RATING ERROR”**
 - ❑ Registration of Thumbs Up/Down has failed.
- **“SEARCH ERROR”**
 - ❑ No station could be searched for.
- **“STATION LIMIT”**
 - ❑ The number of registered stations has reached the upper limit.
 - ➡ Retry after deleting an unnecessary station.
- **“UPGRADE APP”**
 - ❑ The Pandora application is an older version which the unit can not support. Confirm that the Pandora application is the latest version.

Aha Messages

- **“ACTN DISABLED”**
 - ❑ You performed an unavailable operation.
- **“AHA APP UPDATE REQUIRED”**
 - ❑ Upgrade the aha application to the latest version.
- **“AHA UNAVAILABLE”**
 - ❑ Your smartphone cannot be connected to Aha Radio server.
- **“CHECK APP”**
 - ❑ Log in to aha.
- **“CHECK DEVICE”**
 - ❑ Aha application has not started, you have not signed in, or system maintenance is in progress.
- **“CONNECT PHONE”**
 - ❑ Connect the cell-phone.
- **“LOGIN FAILED”**
 - ❑ Logging in to aha has failed.
- **“NETWORK UNAVAILABLE”**
 - ❑ The network has been disconnected.
- **“NO CONTENT”**
 - ❑ There is no receivable content.
- **“POOR GPS”**
 - ❑ The GPS reception condition of your smartphone is poor.

Accessories/ Installation Procedure

Installation accessories

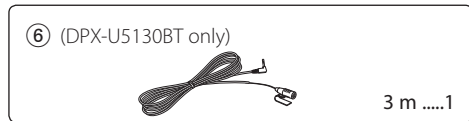
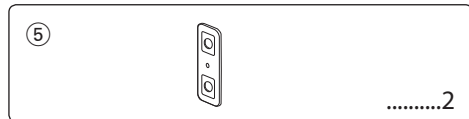
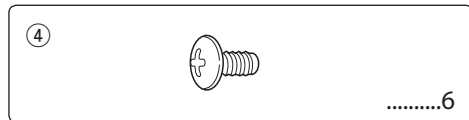
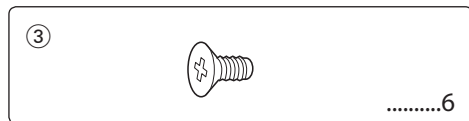
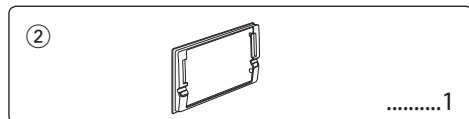
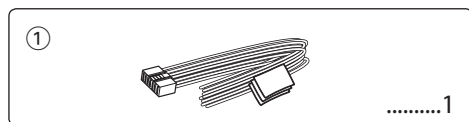

Installation Procedure

- 1 To prevent a short circuit, remove the key from the ignition and disconnect the \ominus battery.
- 2 Make the proper input and output wire connections for each unit.
- 3 Connect the speaker wires of the wiring harness.
- 4 Connect the wiring harness wires in the following order: ground, battery, ignition.
- 5 Connect the wiring harness connector to the unit.
- 6 Install the unit in your car.
- 7 Reconnect the \ominus battery.
- 8 Press the reset button.

▲ WARNING

- If you connect the ignition wire (red) and the battery wire (yellow) to the car chassis (ground), you may cause a short circuit, that in turn may start a fire. Always connect those wires to the power source running through the fuse box.

▲ CAUTION

- Mounting and wiring this product requires skills and experience. For safety's sake, leave the mounting and wiring work to professionals.
- Make sure to ground the unit to a negative 12V DC power supply.
- Do not install the unit in a spot exposed to direct sunlight or excessive heat or humidity. Also avoid places with too much dust or the possibility of water splashing.
- Do not use your own screws. Use only the supplied screws. Using wrong screws, could damage the unit.
- If the power is not turned ON ("PROTECT" appears), the speaker wire may have a short-circuit or touched the chassis of the vehicle and the protection function may have been activated. Therefore, the speaker wire should be checked.
- If your car's ignition key switch does not have an ACC position, connect the ignition wires to a power source that can be turned on and off with the ignition key. If you connect the ignition wires to a constant-voltage power source, as with battery wires, the battery may die.
- If the console has a lid, make sure to install the unit so that the faceplate will not hit the lid when it is closed or opened.
- If the fuse blows, first make sure the wires are not touching other parts to cause a short circuit, and then replace the old fuse with one with a new the same rating.
- Insulate unconnected wires with vinyl tape or other similar materials. To prevent a short circuit, do not remove the caps on the ends of the unconnected wires and terminals.
- Connect the speaker wires correctly to the corresponding terminals. The unit may be damaged or fail to work if you share the \ominus wires or ground them to any metal part in the car.
- When connecting only two speakers, connect the connectors either to both of the front output terminals or to both of the rear output terminals (do not mix front and rear terminals). For example, if you connect the \oplus connector of the left speaker to a front output terminal, do not connect the \ominus connector to a rear output terminal.
- After the installing the unit, check whether the brake lamps, blinkers, wipers, etc. on the car are working properly.
- Mount the unit so that the mounting angle is 30° or less.
- Reception may become poor if there are metal objects near the Bluetooth antenna. (DPX-U5130BT only)

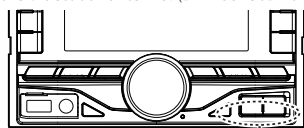

Bluetooth antenna unit

For Good Reception

To assure good reception, note the following:

- Communicate with the cell-phone within the line-of-sight distance of 10 m (30 ft). The communication range becomes shorter depending on the surrounding environment. The communication range also becomes shorter when there is an obstacle between this unit and the cell-phone. The above maximum communication range (10 m) is not always assured.
- A broadcast station or walkie-talkie located nearby can interfere with communication due to a too strong signal.

Connecting Wires to Terminals

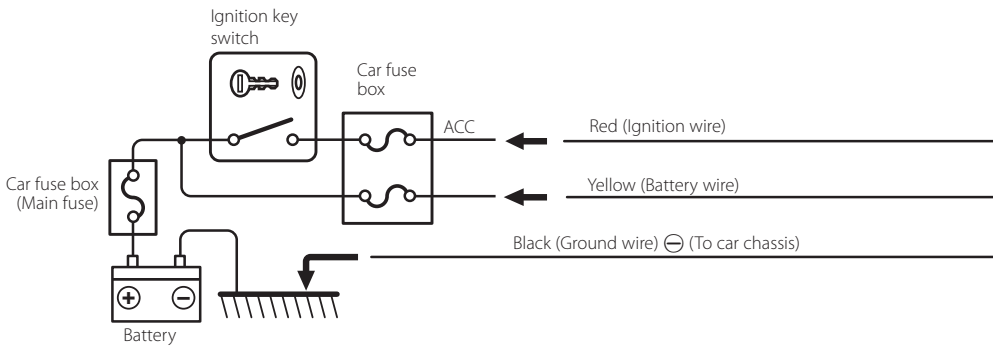
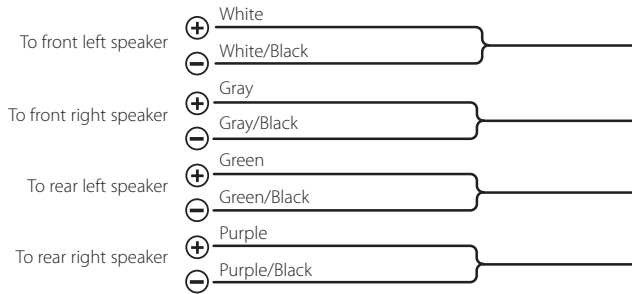
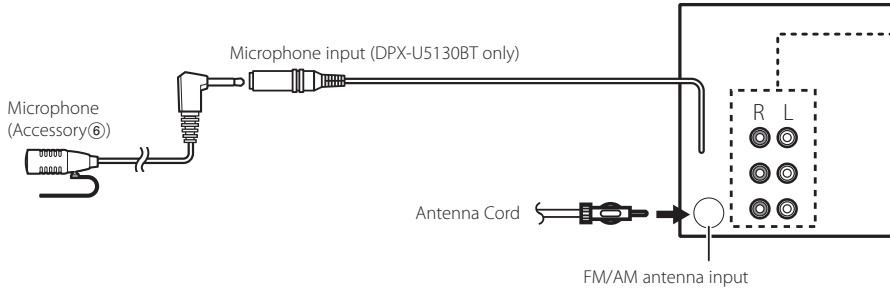

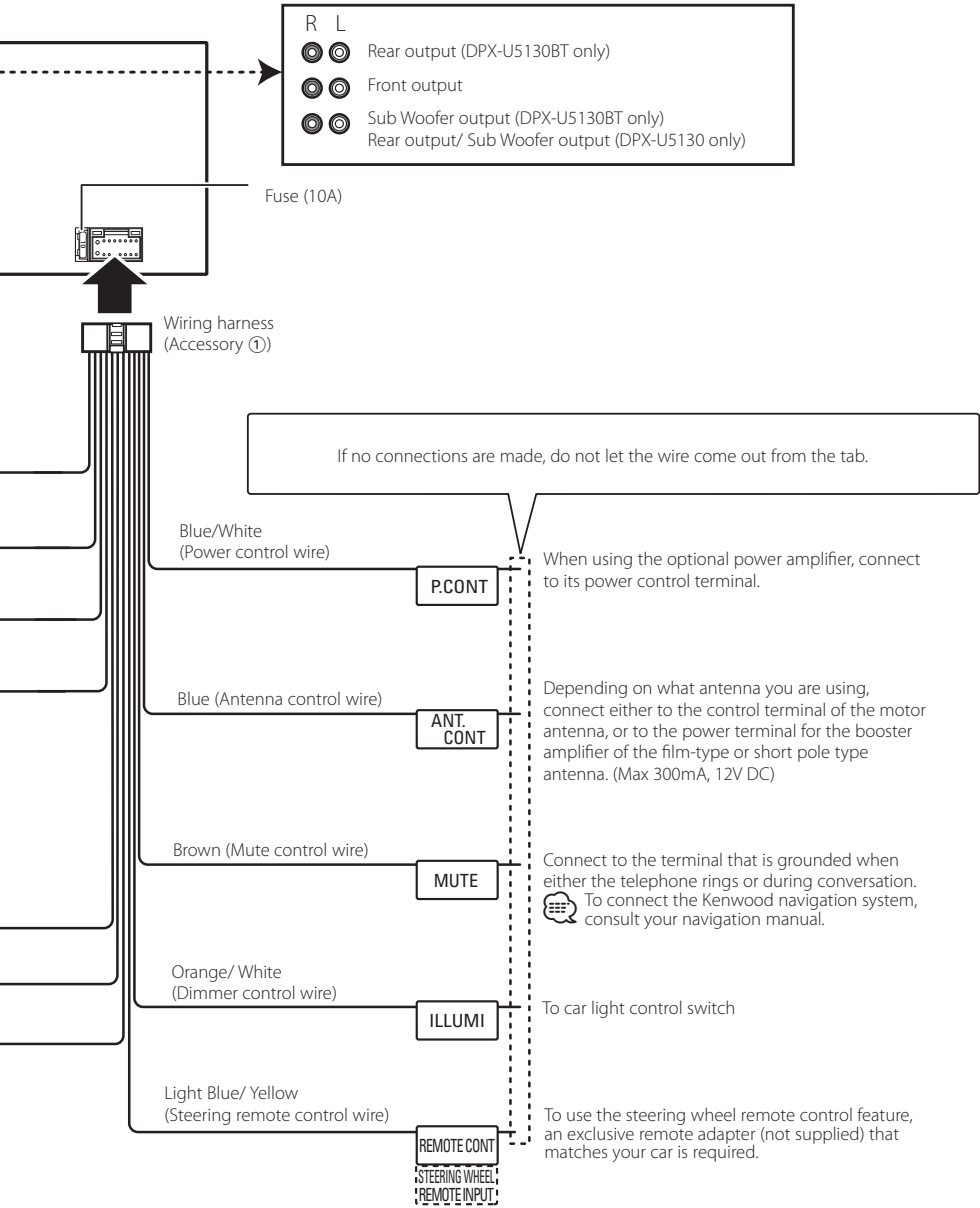

Installation

Installation

Install onto the car bracket using the supplied screws (M5 × 8 mm). The holes of the car bracket to use will differ depending on the car model.

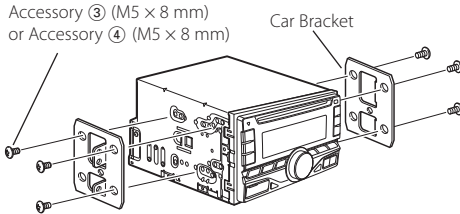

Installing Toyota Cars

Install onto the car bracket using the supplied screws (Accessory ④). Use the mounting holes (● in the illustration shown below) that fit the car bracket.

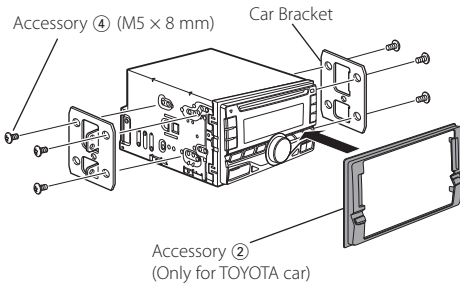
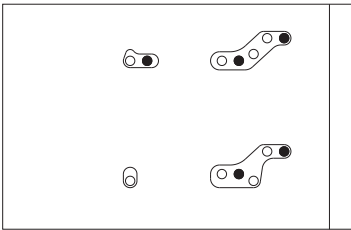

Installing Nissan Cars that uses accessory ③

Install onto the car bracket using the supplied screws (Accessory ③). Use the mounting holes (● in the illustration shown below) that fit the car bracket.

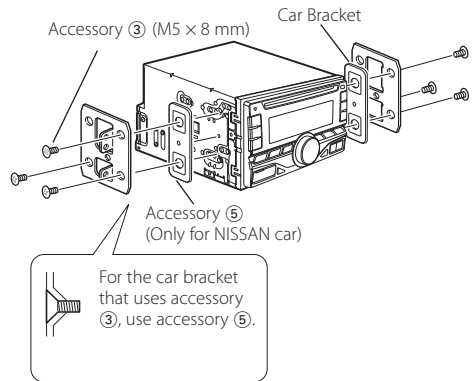
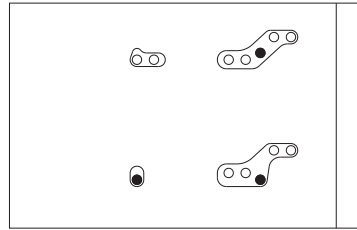

DPX-U5130BT only

Installation the Microphone Unit

- 1 Check the installation position of the microphone (accessory ⑥).
- 2 Remove oil and other dirt from the installation surface.
- 3 Install the microphone.
- 4 Lay the cable up to the unit with it secured at several positions using tape or the like.



- Install the microphone as far as possible from the cell-phone.

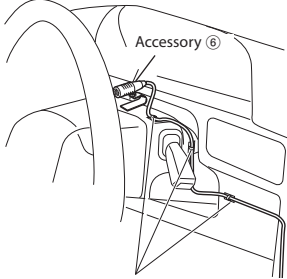

Fix a cable with a commercial item of tape.

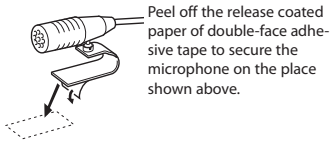

Peel off the release coated paper of double-face adhesive tape to secure the microphone on the place shown above.



Adjust the direction of the microphone to the driver.

KENWOOD