

KENWOOD

DVD COMPACT Hi-Fi COMPONENT SYSTEM

M-909DV

INSTRUCTION MANUAL

Kenwood Corporation

This model consists of a main unit (RXD-M909) and a pair of speakers (LS-M909).

Declaration of Conformity with regard to the EMC Directive 2004/108/EC

Manufacturer:

Kenwood Corporation

2967-3 Ishikawa-machi, Hachioji-shi, Tokyo, 192-8525 Japan

EU Representative's:

Kenwood Electronics Europe BV

Amsterdamseweg 37, 1422 AC UITHOORN, The Netherlands



MP3/WMA **RDS**



Before applying power





⚠ Caution : Read this page carefully to ensure safe operation.

Units are designed for operation as follows.

Australia AC 240 V only
Europe AC 230 V only

Safety precautions

WARNING : TO PREVENT FIRE OR ELECTRIC SHOCK, DO NOT EXPOSE THIS APPLIANCE TO RAIN OR MOISTURE.

	CAUTION RISK OF ELECTRIC SHOCK DO NOT OPEN	
CAUTION: TO REDUCE THE RISK OF ELECTRIC SHOCK, DO NOT REMOVE COVER (OR BACK). NO USER-SERVICEABLE PARTS INSIDE. REFER SERVICING TO QUALIFIED SERVICE PERSONNEL.		
	THE LIGHTNING FLASH WITH ARROWHEAD SYMBOL, WITHIN AN EQUILATERAL TRIANGLE, IS INTENDED TO ALERT THE USER TO THE PRESENCE OF UNINSULATED "DANGEROUS VOLTAGE" WITHIN THE PRODUCT'S ENCLOSURE THAT MAY BE OF SUFFICIENT MAGNITUDE TO CONSTITUTE A RISK OF ELECTRIC SHOCK TO PERSONS.	
	THE EXCLAMATION POINT WITHIN AN EQUILATERAL TRIANGLE IS INTENDED TO ALERT THE USER TO THE PRESENCE OF IMPORTANT OPERATING AND MAINTENANCE (SERVICING) INSTRUCTIONS IN THE LITERATURE ACCOMPANYING THE APPLIANCE.	

The marking of products using lasers

**CLASS 1 LASER PRODUCT
KLASSE 1 LASER PRODUKT
LUOKAN 1 LASER LAITE
KLASS 1 LASER APPARAT
CLASSE 1 PRODUIT LASER**

The marking this product has been classified as Class 1. It means that there is no danger of hazardous radiation outside the product.

Location: Bottom

IMPORTANT SAFETY INSTRUCTIONS

⚠ Caution : Read this page carefully to ensure safe operation.

Read Instructions – All the safety and operating instructions should be read before the product is operated.

Retain Instructions – The safety and operating instructions should be retained for future reference.

Heed Warnings – All warnings on the product and in the operating instructions should be adhered to.

Follow Instructions – All operating and use instructions should be followed.

- 1. Cleaning** – Unplug this product from the wall outlet before cleaning. Do not use liquid cleaners or aerosol cleaners. Use a damp cloth for cleaning.
- 2. Attachments** – Do not use attachments not recommended by the product manufacturer as they may cause hazards.
- 3. Water and Moisture** – This product shall not be exposed to dripping and splashing – for example, near a bath tub, wash bowl, kitchen sink, or laundry tub; in a wet basement; or near a swimming pool; and the like. Do not place an object containing liquid, such as a flower vase, on the appliance.
- 4. Accessories** – Do not place this product on an unstable cart, stand, tripod, bracket, or table. The product may fall, causing serious injury to a child or adult, and serious damage to the product. Use only with a cart, stand, tripod, bracket, or table recommended by the manufacturer. Any mounting of the product should follow the manufacturer's instructions, and should use a mounting accessory recommended by the manufacturer.

A product and cart combination should be moved with care. Quick stops, excessive force, and uneven surfaces may cause the product and cart combination to overturn.

- 5. Ventilation** – Slots and openings in the cabinet are provided for ventilation and to ensure reliable operation of the product and to protect it from overheating, and these openings must not be blocked or covered. The openings should never be blocked by placing the product on a bed, sofa, rug, or other similar surface. This product should not be placed in a built-in installation such as a bookcase or rack unless proper ventilation is provided or the manufacturer's instructions have been adhered to.

6. Power Sources – This product should be operated only from the type of power source indicated on the product. If you are not sure of the type of power supply to your home, consult your product dealer or local power company.

7. CAUTION – Polarization – This product may be equipped with a polarized alternating-current line plug (a plug having one blade wider than the other). This plug will fit into the power outlet only one way. This is a safety feature. If you are unable to insert the plug fully into the outlet, try reversing the plug. If the plug should still fail to fit, contact your electrician to replace your obsolete outlet. Do not defeat the safety purpose of the polarized plug.

8. Power Cord Protection – Power-supply cords should be routed so that they are not likely to be walked on or pinched by items placed upon or against them, paying particular attention to cords at plugs, convenience receptacles, and the point where they exit from the product.

9. Lightning – For added protection for this product during a lightning storm, or when it is left unattended and unused for long periods of time, unplug it from the wall outlet and disconnect the antenna or cable system. This will prevent damage to the product due to lightning and power-line surges.

10. Overloading – Do not overload wall outlets, extension cords, or integral convenience receptacles as this can result in a risk of fire or electric shock.

11. Object and Liquid Entry – Never push objects of any kind into this product through openings as they may touch dangerous voltage points or short-out parts that could result in a fire or electric shock. Never spill liquid of any kind on the product.

12. Servicing – Do not attempt to service this product yourself as opening or removing covers may expose you to dangerous voltage or other hazards. Refer all servicing to qualified service personnel.

13. Damage Requiring Service – Unplug this product from the wall outlet and refer servicing to qualified service personnel under the following conditions:

- a) When the power-supply cord or plug is damaged,
- b) If liquid has been spilled, or objects have fallen into the product,
- c) If the product has been exposed to rain or water,
- d) If the product does not operate normally by following the operating instructions.
- e) If the product has been dropped or damaged in any way, and
- f) When the product exhibits a distinct change in performance – this indicates a need for service.
- g) If an abnormal smell or smoke is detected.

14. Replacement Parts – When replacement parts are required, be sure the service technician has used replacement parts specified by the manufacturer or have the same characteristics as the original part. Unauthorized substitutions may result in fire, electric shock, or other hazards.

15. Safety Check – Upon completion of any service or repairs to this product, ask the service technician to perform safety checks to determine that the product is in proper operating condition.

16. Wall or Ceiling Mounting – This product should be mounted to a wall or ceiling only as recommended by the manufacturer.

17. Heat – This product should be situated away from heat sources such as radiators, heat registers, stoves, or other products that produce heat. Do not place a flaming object, such as a candle or lantern, or near the product.

18. Power Lines – An outside antenna system should not be located in the vicinity of overhead power lines or other electric light or power circuits, or where it can fall into such power lines or circuits. When installing an outside antenna system, extreme care should be taken to keep from touching such power lines or circuits as contact with them might be fatal.

19. Outdoor Antenna Grounding – If an outside antenna or cable system is connected to the product, be sure the antenna or cable system is grounded so as to provide some protection against voltage surges and built-up static charges. Article 810 of the National Electrical Code, ANSI/NFPA 70, provides information with regard to proper grounding of the mast and supporting structure, grounding of the lead-in wire to an antenna discharge unit, size of grounding conductors, location of antenna-discharge unit, connection to grounding electrodes, and requirements for the grounding electrode.

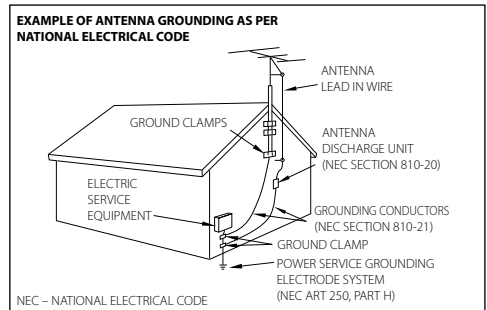





Notes:

1. Item 7 is not required except for grounded or polarized equipment.
2. Item 19 complies with UL in the U.S.A.

Contents

Caution : Read the pages marked  carefully to ensure safe operation.

 Before applying power	2
 Safety precautions	2
 IMPORTANT SAFETY INSTRUCTIONS	2
Disc information	5
Connections	6
Names and functions of parts	8
Settings	10
OSD Initial language settings	10
Initial Setting the Area Code.....	10
Symbol Used in this Manual.....	10
Adjust the settings.....	10
LANGUAGE	10
DISPLAY	11
AUDIO.....	11
LOCK.....	11
OTHERS.....	11
Displaying Disc Information.....	12
Hierarchical structure of VCD menus (P.B.C. function) 	12
Setting the Clock.....	12
Setting the sound mode	13
Operations	13
Playing a Disc	13
Playing a DivX movie file	15
Listening to Audio CD, MP3 or WMA files	15
Viewing photo files 	16
Listening to the radio.....	17
Listening to cassette tapes.....	17
Tape Recording.....	18
CD Synchronized Recording	18
Listening to music from your portable player.....	18
Connecting your portable USB player	19
USB Direct Recording	19
Notes	20
Language Codes / Area Codes	22
In case of difficulty	23
Specifications	24

Unpacking

Unpack the unit carefully and make sure that all accessories are present.

Video code (Yellow)	(x 1)
FM indoor antenna.....	(x 1)
AM loop antenna.....	(x 1)
Remote control unit.....	(x 1)
Battery (AAA/R3)	(x 2)

If any accessories are missing, or if the unit is damaged or falls to operate, notify your dealer immediately. If your unit was shipped to you directly, notify your shipper immediately. Kenwood recommends that you retain the original carton and packing materials in case you need to move or ship the unit in the future.

Keep this manual handy for future reference.

About the Symbol Display

"" may appear on your TV display during operation and indicates that the function explained in this instruction manual is not available.

Video formats

You must select the appropriate system mode for your TV system. Remove any disc that might be in the unit, press and hold **[STEP (II)]** for more than 5 seconds to be able to select a system (PAL, NTSC, AUTO).











Standby mode

While the standby indicator is lit, a small amount of power is supplied to the system to back up the memory. This is called standby mode. Under the condition, the system can be turned ON by the remote control unit.

Disc information

Types of Playable Discs

The system this unit is using does not only play music from CD but can also play the discs listed below to offer you high-quality entertainment of video of movies and live concerts.

Playable Disc		DVD VIDEO (DVD-R/RW, DVD+R/RW)		CD (CD-R, CD-RW)		VCD (SVCD*)	
Logo mark on disc							
Disc size		 8 cm	 12 cm	 8 cm	 12 cm	 8 cm	 12 cm
Played sides		One or both	One or both	One side only	One side only	One side only	One side only
Contents	Video + Audio	Approx. 41 min. (1 side, 1 layer) Approx. 75 min. (1 side, 2 layers) Approx. 82 min. (2 sides, 1 layer) Approx. 150 min. (2 sides, 2 layers)	Approx. 133 min. (1 side, 1 layer) Approx. 242 min. (1 side, 2 layers) Approx. 266 min. (2 sides, 1 layer) Approx. 484 min. (2 sides, 2 layers)	/	/	Max. 20 min.	Max. 74 min.
	Audio	/	/			Max. 20 min., digital	Max. 80 min., digital

* This unit can play SVCDs, but some functions will not work.

- A Dual Disc is a two-sided disc combining a DVD side according to the DVD standard and a music side. The video content recorded on the DVD side can be played back. As the music side is not compatible with the Compact Disc (CD) standard, playback on this unit is not assured.
- This unit can play back DVD-R and DVD-RW discs recorded in the DVD VIDEO format and DVD+R and DVD+RW discs, but depending on the recording unit, the disc manufacturer, etc., playback sometimes may not be possible.
- This unit may also be incapable of playing certain CD-R/RW discs depending on their properties, recording conditions, etc.
- This player cannot play back discs compatible with CPRM. CPRM is the abbreviation of Content Protection for Recordable Media, and it is a technique for copyright protection for recording media.

Unplayable discs

This player cannot play back any of the following discs.

DVD AUDIO discs, DVD-RAM discs, SACD discs, VSD discs, CDV discs (Only the audio part can be reproduced.), CD-G/CD-EG/CD-EXTRA discs (Only the audio can be reproduced.)

Regional code

This unit has a regional code printed on the rear of the unit. This unit can play only DVD discs labeled same as the rear of the unit or "ALL".

- Most DVD discs have a globe with one or more numbers in it clearly visible on the cover. This number must match your unit's regional code or the disc cannot play.
- If you try to play a DVD with a different regional code from your unit, the message "Check Regional Code" appears on the TV screen.

Connections

Antenna connection

Fit the AM loop aerial to its stand

Connect the AM loop aerial to the unit.

Connect the FM aerial

The reception will be at its best when the two loose ends of the aerial are in a straight line and horizontal.

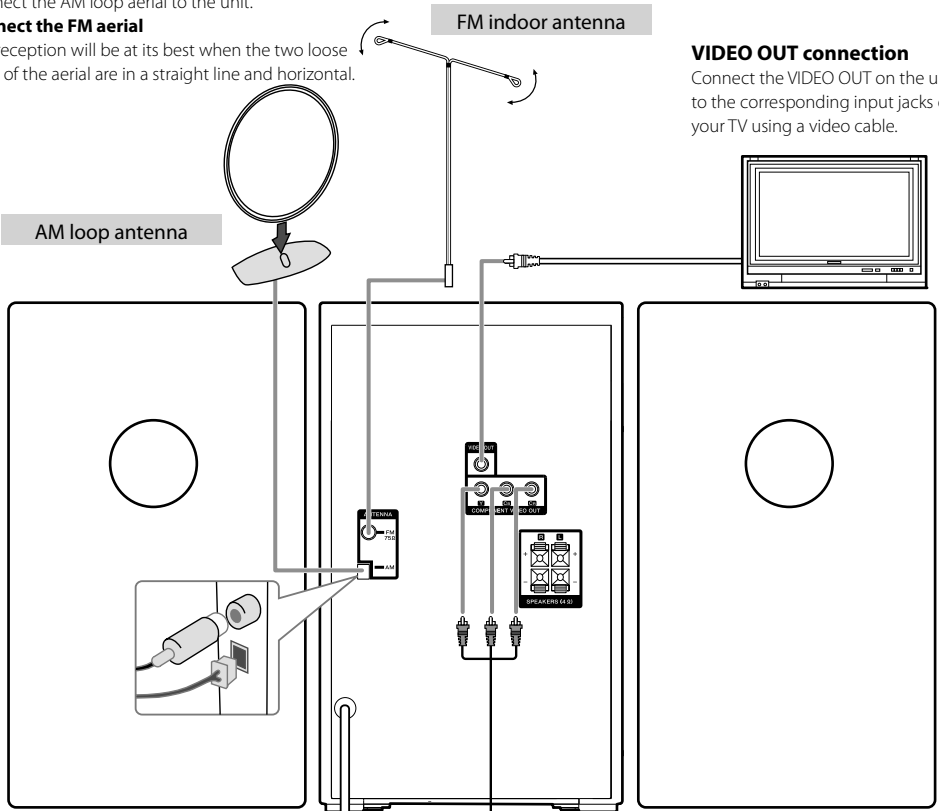

To AC wall outlet

- Insert the plug firmly all the way into the AC wall outlet.

⚠ CAUTION

The power in this equipment will not be completely cut off from the wall outlet when the standby switch is turned off. Install the equipment so that the wall outlet is easily accessible and, in case of emergency, immediately unplug the power cord from the wall outlet.

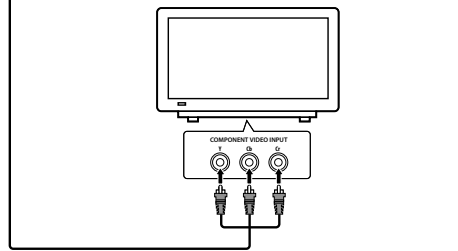

Attaching the speakers to the unit

Connect the wires to the unit.

To connect the cable to the unit, press each plastic finger pad to open the connection terminal. The connector will open ready to receive a cable. Insert the wire and release the finger pad.

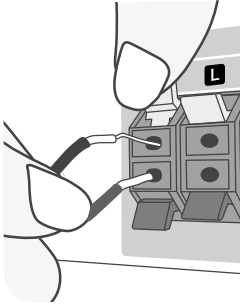

Connect the red end of each wire to the terminals marked +(plus) and the black end to the terminals marked - (minus).

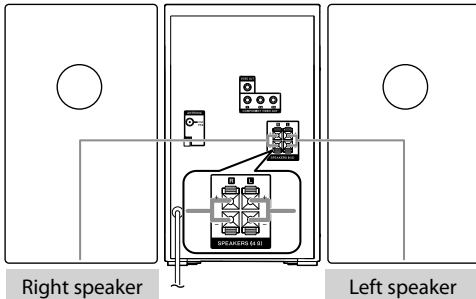

Right speaker

Left speaker

⚠ CAUTION

Be sure to adhere to the following, or proper ventilation will be blocked causing damage or fire hazard.

- Do not place any objects impairing heat radiation onto the top of the unit.
- Leave some space around the unit (from the largest outside dimension including projection) equal to or greater than, shown below.

Top panel : 50 cm Back panel : 10 cm

Remote control Battery Installation

Detach the battery cover on the rear of the remote control, and insert two R03 (size AAA) batteries with ⊕ and ⊖ aligned correctly. Do not mix old and new batteries. Never mix different types of batteries (standard, alkaline, etc.).

1 Remove the cover.

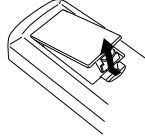

2 Insert batteries.

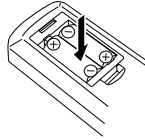

3 Close the cover.

⚠ CAUTION

Do not leave the battery near fire or under direct sunlight. A fire, explosion or excessive heat generation may result.

Remote control Operation

Point the remote control at the remote sensor and press the buttons.

Remote sensor

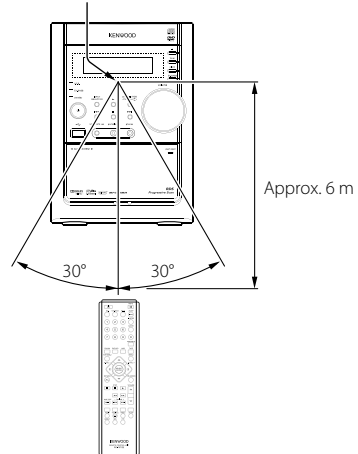

Names and functions of parts

Main unit

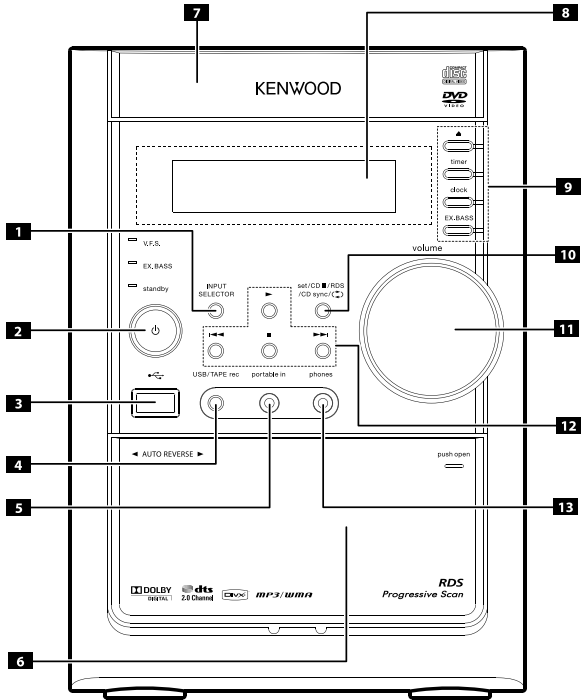

1 INPUT SELECTOR

To select the functions press [INPUT SELECTOR].
(DVD/CD → USB → PORTABLE → TAPE → FM → AM)

2 (Power)

To switch the system on or to standby mode.

3 USB connector

Connect a remote USB compatible player here.

4 USB/TAPE rec

USB Record (Page 19)/TAPE Record (Page 18)

5 portable in

For connecting a portable device and playing it through the system's speaker.

6 PUSH EJECT-TAPE

7 Disc tray

8 Display window

9 ▲ OPEN/CLOSE

- timer

- clock

- EX.BASS (MP3/WMA Optimizer)

Reinforce the bass. EX.BASS ON will show in the display.
Press again for cancel. (Page 13)

10 • set Confirms the time you have selected when setting the clock.

- CDII CD, DVD, VCD, USB : Pause

- RDS Shows information about radio stations. (see listening to the radio)

- CD sync CD to Tape Synchronized Recording

- ↻ Scroll through a selection of cassette playing options.

11 Volume adjustment

The speaker and headphone volume can be adjusted separately.

12 • |◀◀ or ▶▶|

- Tuner : Auto Tuning (Press the [◀◀] or [▶▶] for 2 seconds.)

- Tape : Rewind or Fast Forward

- CD, DVD, VCD, USB : Skip or Scan

▶

- Tape : Forward / Reverse Play

- CD, DVD, VCD, USB : Play or X1.5 play (Page 13)

- Stops playback

13 Headphone jack

Connect a headphone plug (φ3.5 mm) into the jack to listen to the sound through headphones (not supplied).

Remote control unit

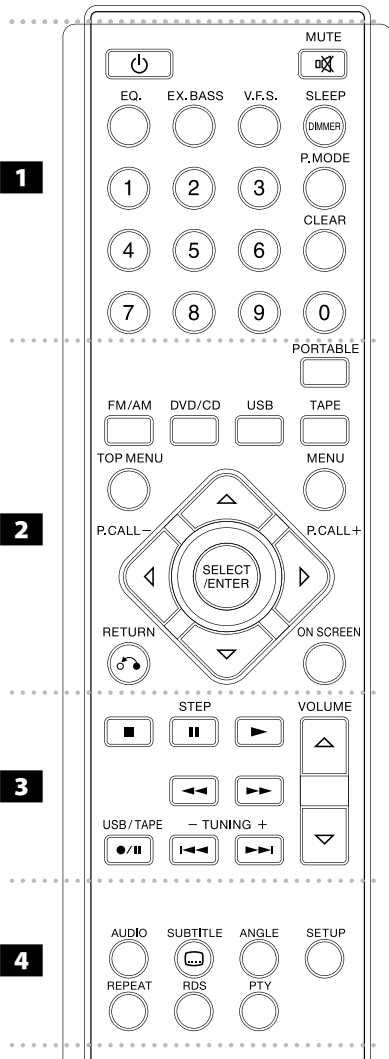

• • • • • **1** • • • • •

⏻: Switches the unit ON or OFF.

MUTE: Press **[MUTE]** to mute your unit.

EQ (EQUALIZER Effect): You can choose 7 fixed sound impressions. (page 13)

EX.BASS: Reinforce the bass. EX.BASS ON will show in the display. Press again for cancel. (Page 13)

V.F.S.: Press **[V.F.S.]** to set the virtual front sound. (page 13)

SLEEP: You can set the unit to turn off automatically at a specified time.

- **DIMMER** The LED (Light-emitting diode) of front panel is turned off and the display window will be darken. (page 12)

P.MODE: Add the music or photo to the Program list.

To 'save' a radio station.

CLEAR: Removes a track number on the Program List.

0-9 numerical buttons: Selects numbered options in a menu.

• • • • • **2** • • • • •

Source buttons (FM/AM / DVD/CD / USB / TAPE / PORTABLE)

: To select the source you want.

TOP MENU: If the current DVD title has a menu, the title menu appears on the screen. Otherwise, the disc menu may appear.

MENU: Accesses the menu on a DVD disc.

RETURN: Returns on a VCD with PBC.

ON SCREEN: Accesses On-Screen Display.

<|> / Δ / ▽ (left/right/up/down): Used to navigate onscreen displays.

SELECT/ENTER: Acknowledges menu selection.

• • • • • **3** • • • • •

■ (STOP): Stops playback or recording.

- **MONO/STEREO** FM mode state, selects MONO or STEREO by pressing **■ (STOP)** button.

STEP (II): Pause playback or recording temporarily/press repeatedly for frame-by-frame playback.

▶: Starts playback.

- **Tape reverse playback** Press **▶ (PLAY)** once again.

- **1.5 speed playback**

The 1.5 speed allows you to watch the pictures and listen to the sound quicker than playing at a normal speed on the disc. (page 13)

◀◀/▶▶: Search backward or forward.

USB/TAPE (●/II): USB Direct Recording /Tape Record

You can record one desired file or all of the music files in AUDIO CD to USB -(page 19). Or records from a TUNER, DVD/CD, USB or PORTABLE to cassette - (page18).

TUNING (-/+) (**◀◀/▶▶**): Go to next or previous chapter/ track/Title.

Tunes in the desired radio station.

VOLUME (Δ/▽): Adjusts speaker volume.

• • • • • **4** • • • • •

AUDIO: Selects an audio language or an audio channel.

SUBTITLE: During playback, **[SUBTITLE]** repeatedly to select a desired subtitle language.

ANGLE: Selects a DVD camera angle.

SETUP: Accesses or removes setup menu.

REPEAT: Repeats a Chapter/ Track/ Title all.



RDS: Radio display mode.

PTY: Views the various displays of the RDS.

Settings

OSD Initial language settings

After factory setting, this beginning menu language will only be displayed at DVD or USB mode if you turn on the power at the first time.

Operation	MAIN UNIT	ON REMOTE
1 Turn the power on : Appear the language list display window.		
2 Select the language :	-	△ ▽ ◀ ▶
3 Press :	-	SELECT/ ENTER
4 To confirm press :	-	SELECT/ ENTER

Initial Setting the Area Code

After factory setting, To set the Area code you have to as below.

Operation	ON REMOTE
1 Display setup menu :	SETUP
2 Select LOCK menu on the first level :	△ ▽
3 Move to second level : Appears the activated Area code on the second level.	▶
4 Move to third level :	▶
5 Enter the new pass word and then, press	Numerical button of 0~ 9 then, SELECT/ ENTER
6 Recheck entered new pass word and then, press	Numerical button of 0~ 9 then, SELECT/ ENTER
7 Select a code for a geographic area : After select, Rating and Passward will be activated. (page 22)	△ ▽ ◀ ▶
8 Confirm the setting :	SELECT/ENTER

Symbol Used in this Manual

All discs and file listed below		MP3 files	
DVD and finalized DVD±R/RW		WMA files	
Video CDs		DivX files	
Audio CDs		JPEG files	

Adjust the settings

Operation	ON REMOTE
1 Display setup menu :	SETUP
2 Select a desired option on the first level :	△ ▽
3 Move to second level :	▶
4 Select a desired option on the second level :	△ ▽
5 Move to third level :	▶
6 Change the setting :	△ ▽ and SELECT/ENTER

Adjust the settings - more you can do

LANGUAGE



OSD – Select a language for the Setup menu and on-screen display.

Disc Audio/Disc Subtitle/Disc Menu  – Select a language for the Menu/Audio/Subtitle.

[Original]: Refers to the original language in which the disc was recorded.

[Others]: To select another language, press number buttons then **[SELECT/ENTER]** to enter the corresponding 4-digit number according to the language code list in the reference chapter.

If you make a mistake while entering number, press **[CLEAR]** to delete numbers then correct it.

[OFF] (for Disc Subtitle): Turn off Subtitle.

DISPLAY



TV Aspect – Select which screen aspect to use based on the shape of your TV screen.

[4:3]: Select when a standard 4:3 TV is connected.

[16:9]: Select when a 16:9 wide TV is connected.

Display Mode – If you selected 4:3, you'll need to define how you would like widescreen programs and films to be displayed on your TV screen.

[Letterbox]: This displays a widescreen picture with black bands at the top and bottom of the screen.

[Panscan]: This fills the entire 4:3 screen, cropping the picture as necessary.

Progressive Scan – Progressive Scan Video provides the high quality pictures with less flickering. If you are using the Component Video jacks for connection to a TV or monitor that is compatible with a progressive scan signal, set [Progressive Scan] to [On].

Press **[SELECT/ENTER]** to confirm your selection.

- If you not press **[ENTER]** within 10 seconds it will be [OFF].

- If you have no progressive scan TV, in the state progressive scan [On] will not appear the screen. If you set Progressive Scan to [On] in error, press and hold **[M]** key for about 3 seconds. Set Progressive Scan to [Off].

AUDIO



DRC (Dynamic Range Control) (DVD) – Make the sound clear when the volume is turned down (Dolby Digital only). Set to [On] for this effect.

Vocal (DVD) – Select [On] to mix karaoke channels into normal stereo. This function is effective for multi-channel karaoke DVDs only.

LOCK

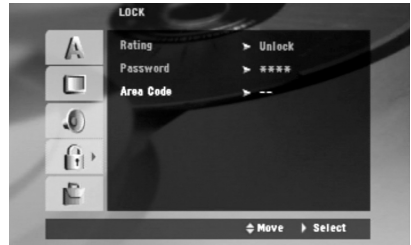

To access the lock options, you must enter the 4-digit password. If you have not yet entered a password you are prompted to do so. Enter a 4-digit password.

Enter it again to verify. If you make a mistake while entering number, press **[CLEAR]** to delete numbers then correct it.

If you forget your password you can reset it. Press **[SETUP]** and Input "210499".

The password has now been cleared.

Rating (DVD) – Select a rating level. The lower the level, the stricter the rating. Select [UNLOCK] to deactivate the rating.

Password – Sets or changes the password for lock settings.

[New]: Enter a new 4-digits password using the numerical buttons then press **[SELECT/ENTER]**. Enter the password again to confirm.

[Change]: Enter the new password twice after entering the current password.

Area code (DVD) – Select a code for a geographic area as the playback rating level.

This determines which area's standards are used to rate DVDs controlled by the parental lock. See the Area Codes on page 22.

OTHERS



PBC (Playback Control) (VCD) – Playback control provides special navigation features that are available on some Video CDs. Select [On] to use this feature.

DivX (R) Registration (DivX) – We provide you with the DivX® VOD (Video On Demand) registration code that allows you to rent and purchase videos using the DivX® VOD service. For more information, visit www.divx.com/vod.

Press **[SELECT/ENTER]** when [Select] icon is highlighted and you can view the registration code of the unit.

Bit Rate – Select Bit Rate signal speed 96kbps or 128kbps (USB Rec. Bit rate)

Displaying Disc Information

Operation	ON REMOTE
1 Press :	ON SCREEN
2 Select a item :	△ ▽
3 Adjust the Display menu settings :	< ▢ >
4 To return the exit :	ON SCREEN

Displaying Disc Information - more you can do

You can select an item by pressing [△▽] and change or select the setting by pressing [< ▢ >].

	1/2	1	1. Current title (or track) number/total number of titles (or tracks)
	1/13	2	2. Current chapter number/total number of chapters
	0:00:00	3	3. Elapsed playing time
	1 ENG	4	4. Selected audio language or channel
	Off	5	5. Selected subtitle
	1/1	6	6. Selected angle/total number of angles
	Bypass	7	7. Selected Sound mode

Hierarchical structure of VCD menus (P.B.C. function) VCD

Example for a hierarchical structure

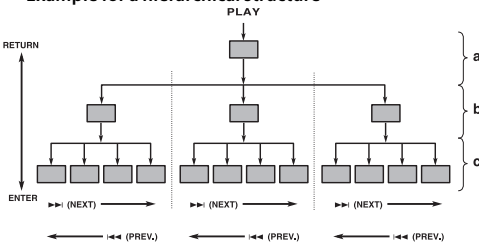

- a: First level (menu)
- b: Second level (submenu)
- c: Third level (scenes)

Advancing

When an item is selected on the menu screen with the [ENTER] or the numerical buttons, advance is made to the next lower menu level. When the advance destination is the "scene" to be played, the contents will be played.

- When several menus (scenes) can be selected in each level, screen switching is possible with the [▶▶] (NEXT) and [◀◀] (PREV).

Returning

Each time the [RETURN] is pressed, return is made to the next higher menu.

Setting the Clock

Operation	MAIN UNIT	ON REMOTE
1 Press for at least 2 seconds :	clock	-
2 Choose from either : AM 12:00 (for an am and pm display) or 0:00 (for a 24 hour display)	◀◀ or ▶▶	-
3 Confirm your selection :	set	-
4 Select the hours :	◀◀ or ▶▶	-
5 Press :	set	-
6 Select the minutes :	◀◀ or ▶▶	-
7 Press :	set	-

NOTES :

- Pressing the [clock] while the system is in the standby mode (OFF) will display the time for 5 seconds.

Timer setting

Press and hold [timer] for 2 seconds. Each function, DVD/CD, USB, TAPE, TUNER flashes for 2 seconds. Press [set] when the function you want to be woken by is showing.

If you choose TUNER, "PLAY" and "REC" flashes in the display window alternately. Choose one of them by pressing the [set] and then, select the preset using [◀◀] or [▶▶] and press [set].

If you choose DVD/CD, USB or TAPE you will be shown below. You will be shown the "ON TIME" display. This is where you set the time you want the timer to go off. Use [◀◀] or [▶▶] to change the hours and minutes and [set] to save. You will then be shown the "OFF TIME" display.

This is where you set the time you want the function to stop. Use [◀◀] or [▶▶] to change the hours and minutes and press [set] to save.

Next you will be shown the volume (VOL) you want to be woken by.

Use [◀◀] or [▶▶] to change the volume and [set] to save. Switch the system off. The clock icon "⌚" shows that the timer is set. To set the timer to go off at a different time, switch the system on and reprogramme following the same steps as initially.

You can also turn the timer on and off by pressing [timer].

NOTES :

- Timer play will not function on DVD and VCD.

Fall asleep while listening to your unit

You can set the unit to turn off automatically at a specified time. Each time you press [SLEEP] the setting changes in the following order.

(DIMMER ON) → SLEEP 180 → 150 → 120 → 90 → 80 → 70 → 60 → 50 → 40 → 30 → 20 → 10 → (DIMMER OFF)

DIMMER

Press [SLEEP] once. The LED (Light-emitting diode) of front panel is turned off and the display window will be darkened by half. To cancel it, press [SLEEP] repeatedly until dim off.

Operations

Setting the sound mode

EX.BASS

Press **[EX.BASS]** to reinforce treble, bass and the surround effect. The "EX.BASS ON" or "NORMAL" indicator lights.

:"EX.BASS ON" ↔ "NORMAL"

WMA **MP3** : "EX.BASS ON" → "MP3 -- OPT ON"*
→ "NORMAL".

*This function optimizes for compressed MP3/WMA files.

EQ (EQUALIZER Effect)

You can choose 7 fixed sound impressions.

Each time you press **[EQ]** the setting changes in the display window as shown below. (AUTO EQ operates only in the MP3/WMA files which include the Tag information.)

"NORMAL" → "(AUTO EQ)" → "POP" → "CLASSIC" → "ROCK" → "JAZZ".

V.F.S. (Virtual Front Sound)

Press **[V.F.S.]** to set the virtual front sound or to change sound mode repeatedly.

- When you press **[Rec]** during V.F.S., appointed sound mode return to BYPASS.

• 2.1Ch source : 3D STEREO

Realtime 3D positioned sound rendering technology with stereo sources, optimized for stereo speakers. Listeners may experience amazing virtual surround effects with their own multimedia players.

"BYPASS" → "VIRTUAL" → "ON STAGE"

• 5.1Ch source : Virtual surround

A patent pending downmix technology converts 5.1 channel to 2 channel sound having directional information of audio.

"BYPASS" → "NATURAL"

NOTES :

- The sound mode cannot be switched during recording.
- V.F.S. cannot be switched in stop mode.
- EQ and V.F.S. are disabled during headphone listening.

Playing a Disc

Operation	MAIN UNIT	ON REMOTE
1 Open the disc tray :	▲	–
2 Insert a disc :	–	–
3 Close the disc tray :	▲	–
4 To start playback :	▶	▶
5 To stop playback : Resume playback stops.	■	■

Playing a Disc - more you can do

Playing a DVD or Video CD that has a menu **DVD**

VCD

Most DVD or Video CD now have menus which load first before the film begins to play. You can navigate these menus using

[△ ▽ <▷] or number button to highlight an option. Press **[SELECT/ENTER]** to select.

Skip to the next/previous chapter/track **ALL**

Press **[▶▶]** to move to the next chapter/track.

Press **[◀◀]** to return to the beginning of the current chapter/track.

Press **[◀◀]** twice briefly to step back to the previous chapter/track.

Pause a playback **ALL**

Press **[STEP (II)]** to pause playback. Press **[▶ (PLAY)]** to continue playback.

Frame-by-Frame playback **DVD** **DivX** **VCD**

Press **[STEP (II)]** repeatedly to play Frame-by-Frame playback.

Playing repeatedly **ALL**

Press **[REPEAT]** repeatedly to select an item to be repeated. The current title, chapter or track will be played back repeatedly. To return to normal playback, press **[REPEAT]** repeatedly to select "Off". On a Video CD with PBC, you must set PBC to Off to use this function.

DivX **VCD** : Track → All → Off

CD **WMA** **MP3** : TRACK → ALL → [OFF No display]

DVD : Chapter → Title → Off

Selecting a subtitle language **DVD** **DivX**

During playback, press **[SUBTITLE]** repeatedly to select a desired subtitle language.

Selecting an audio language **DVD** **DivX**

During playback, press **[AUDIO]** repeatedly to select a desired audio language.

continued to next page

Selecting an audio channel **VCD**

During VCD playback, press **[AUDIO]**. Each press switches the selection.

LEFT → RIGHT → STEREO

Selecting a camera angle **DVD**

During the angle indicator has blinked, press **[ANGLE]**. Select the camera angle with press **[ANGLE]**.

Fast forward or fast reverse

DVD DivX VCD CD WMA MP3

Press **[◀▶]** or **[▶▶]** to play fast forward or fast reverse during playback.

You can change the various playback speed by pressing **[◀▶]** or **[▶▶]** repeatedly. Press **[▶]** (PLAY) to continue play at normal speed.

Watch and listen 1.5 times faster

DVD VCD CD WMA MP3

Press **[▶]** (PLAY) when a disc is already playing to watch and listen to a DVD 1.5 times faster than normal playback speed. ▶ x1.5 will appear on the screen.

Press **[▶]** (PLAY) again to return to normal playback speed.

Slow motion playback **DVD VCD**

While playback is paused, press **[◀▶]** or **[▶▶]** to slow down forward or slow down reverse playback.

You can change the various playback speed by pressing **[◀▶]** or **[▶▶]** repeatedly. Press **[▶]** (PLAY) to continue play at normal speed.

VCD disc can operate slow down forward playback only.

Viewing the title menu **DVD**

Press **[TOP MENU]** to display the disc's title menu, if available.

Viewing the DVD menu **DVD**

Press **[MENU]** to display the disc menu, if available.

Starting play from selected time **DVD DivX**

VCD

Searches for the starting point of entered time code. Press **[ON SCREEN]** then select clock icon "⌚". Enter a time then press **[SELECT/ENTER]**. For example, to find a scene at 1 hours, 10 minutes, and 20 seconds, enter "1 1020" and press **[SELECT/ENTER]**. If you enter the wrong number, press **[CLEAR]** to enter again.

On a Video CD with PBC, you must set PBC to Off to use this function.

Last Scene Memory **DVD**

This unit memorizes last scene from the last disc that is viewed. The last scene remains in memory even if you remove the disc from the player or switch off the unit. If you load a disc that has the scene memorized, the scene is automatically recalled.

Screen Saver

The screen saver appears when you leave the unit in Stop mode for about 5 minutes.

Select a title menu (Mixed disc or USB Flash Drive – DivX, MP3/WMA and JPEG)

When playing a disc or USB Flash Drive contained with DivX, MP3/WMA and JPEG files together, you can select which menu of files you would like to play by pressing **[TOP MENU]**.

Press **[◀▶]** to select the file type (music, photo, movie), then press **[SELECT/ENTER]**. Next, press **[Δ ▽]** to select the desired track or file, then press **[▶]** (PLAY) or **[SELECT/ENTER]** to start playback.

MP3 menu

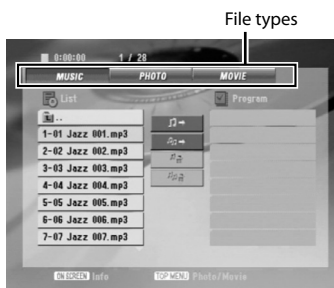

JPEG menu

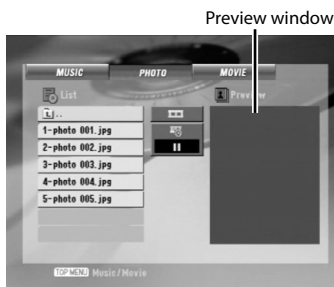

Playing a DivX movie file

Operation	MAIN UNIT	ON REMOTE
1 Open the disc tray :	▲	–
2 Insert a Disc :	–	–
3 Close the disc tray :	▲	–
4 Select a movie file from the menu :	◀▶▶▶	△ ▽
5 To Start playback :	▶	▶
6 To stop playback : Resume playback stops.	■	■

Playing a DivX movie file - more you can do

Changing the character set to display DivX® subtitle correctly

If the subtitle dose not display properly, press and hold **[SUBTITLE]** button about 3 seconds to display the language code menu and then, press **[SUBTITLE]** button repeatedly to change the language code until the subtitle is displayed properly.

DivX disc compatibility with this unit is limited as follows:

- Available resolution size of the DivX file is under 800x600 (W x H) pixel.
- The file name of the DivX subtitle is available by 45 characters.
- If there is impossible code to express in the DivX file, it may be displayed as “_” mark on the display.
- If the number of the screen frame is over 30 per 1 second, this unit may not operate normally.
- If the video and audio structure of recorded files are not interleaved, either video or audio is outpitted.

Playable DivX file : “.avi”, “.mpg”, “.mpeg”, “.divx”

Playable Subtitle format : “.srt”, “.txt”, “.smj”, “.ssa”, “.sub”

Playable Audio format : “.Dolby Digital”, “.PCM”, “.MP3”, “.WMA”.

- Sampling frequency: within 32, 44.1, 48 kHz (MP3), within 24, 32, 44.1, 48kHz (WMA)
- Bit rate: within 32 - 320kbps (MP3), 48 - 192kbps (WMA)

Listening to Audio CD, MP3 or WMA files

Operation	MAIN UNIT	ON REMOTE
1 Open the disc tray :	▲	–
2 Insert a Disc :	–	–
3 Close the disc tray :	▲	–
4 Select a track (file) from the menu :	◀▶▶▶	△ ▽
5 To Start playback :	▶	▶
6 To stop playback : Resume playback stops.	■	■

Listening to Audio CD, MP3 or WMA files - more you can do

Audio CD menu



Creating your own program

You can play the contents of a disc in the order you want by arranging the order of the musics on the disc. The program is cleared when the disc is removed.

Select a desired music then press **[P.MODE]** or select “**♪**” and then press **[SELECT/ENTER]** to add the music to the program list. To add all music in the disc, select “**♪**” and then press **[SELECT/ENTER]**. Select a music from the program list then press **[SELECT/ENTER]** to start programmed playback. To clear a music from the program list, select the music you want to clear then press **[CLEAR]** or select “**♪**” icon and then press **[SELECT/ENTER]**. To clear all music from the program list, select “**♪**” then press **[SELECT/ENTER]**.

continued to next page

Displaying file information (ID3 TAG) **WMA** **MP3**

While playing a MP3 file containing file information, you can display the information by pressing **[ON SCREEN]** repeatedly.

MP3 / WMA disc compatibility with this unit is limited as follows:

- Sampling frequency: within 32, 44.1, 48 kHz (MP3), within 24, 32, 44.1, 48kHz (WMA)
- Bit rate: within 32 - 320kbps (MP3), 48 - 192kbps (WMA)
- The unit cannot read an MP3/WMA file that has a file extension other than ".mp3" / ".wma".
- CD-R physical format should be ISO 9660
- If you record MP3 / WMA files using software that cannot create a file system (eg. Direct-CD) it is impossible to playback MP3 / WMA files. We recommend that you use Easy-CD Creator, which creates an ISO 9660 file system.
- File names should have a maximum of 8 letters and must incorporate an .mp3 or .wma extension.
- They should not contain special letters such as / ? * : " < > | etc.
- The total number of files on the disc should be less than 999.
- This unit requires discs and recordings to meet certain technical standards in order to achieve optimal playback quality. Pre-recorded DVDs are automatically set to these standards. There are many different types of recordable disc formats (including CD-R containing MP3 or WMA files) and these require certain pre-existing conditions (see above) to ensure compatible playback.

Playback from desired track **CD** **WMA** **MP3**

Press the numerical buttons. To select track No. 23: 2, 3.

Viewing photo files **JPEG**

Operation	MAIN UNIT	ON REMOTE
1 Open the disc tray :	▲	–
2 Insert a Disc :	–	–
3 Close the disc tray :	▲	–
4 Select a photo file from the menu :	◀◀ ▶▶	△ ▽
5 To Start playback :	▶	▶
6 To stop playback :	■	■

Viewing photo files - more you can do

Viewing photo files as a slide show

Use [**△ ▽ ◀ ▶**] to highlight () icon then press **[SELECT/ENTER]** to start slide show.

You can change slide show speed using [**◀ ▶**] when () icon is highlighted.

Skip to the next/previous photo

Press [**◀◀**] or [**▶▶**] to view the previous/next photo.

Rotate a photo

Use [**△ ▽ ◀ ▶**] to rotate the photo in full screen.

Pause a slide show

Press **[STEP (II)]** to pause a slide show. Press **[▶ (PLAY)]** to continue the slide show.

JPEG disc compatibility with this unit is limited as follows:

- Depending upon the size and the number of JPEG files, it could take a long time for this unit. To read the disc's contents. If you don't see an onscreen display after several minutes, some of the files may be too large — reduce the resolution of the JPEG files to less than 2M pixels as 2760 x 2048 pixels and burn another disc.
- The total number of files and folders on the disc should be less than 999.
- Some discs may not operate due to a different recording format or the condition of disc.
- Ensure that all the selected files have the ".jpg" extensions when copying into the CD layout.
- If the files have ".jpe" or ".jpeg" extensions, please rename them as ".jpg" file.
- File names without ".jpg" extension will not be able to be read by this unit. Even though the files are shown as JPEG image files in Windows Explorer.
- The file name can be cleared by pressing **[ON SCREEN]**.

Listening to the radio

Operation	MAIN UNIT	ON REMOTE
1 Select FM/ AM :	INPUT SELECTOR	FM/AM
2 Select the radio station :	◀◀ ▶▶	◀◀ ▶▶
3 To select a 'saved' station :	-	<▶

Listening to the radio - more you can do

Look for radio stations automatically

Press [**◀◀ / ▶▶**] on the front panel (or press [**TUNING - / TUNING +**] on the remote control) for more than 0.5 second. The tuner will scan automatically and stop when it finds a radio station.

Delete all the saved stations

Press and hold [**P.MODE**] for two seconds. "ERASE ALL" shows. Press [**P.MODE**] to erase all the saved stations.

To 'save' a radio station

Select a station you want by pressing [**◀◀ / ▶▶**] on the front panel or [**TUNING - /TUNING +**] on the remote control. Press [**P.MODE**], the preset number flashes. Press [**<▶**] on the remote control to select the preset number you want. Press [**P.MODE**] to save it. Up to 50 radio stations can be saved.

Improve poor FM reception

Press [**■ (STOP)**] on the remote control. This will change the tuner from stereo to mono and usually improve the reception.

See information about your radio stations

The FM tuner is supplied with the Radio Data System (RDS) facility. This shows the letters RDS on the display, plus information about the radio station being listened to. Press [**RDS**] on the remote control several times to view the information.

PTY - Programme Type, such as News, Sport, Jazz.

RT - Radio Text, the name of the radio station.

CT - Time Control, the time at the location of the radio station.

PS - Programme Service name, the name of channel.

You can search the radio stations by programme type by pressing [**RDS**].

The display will show the last PTY in use. Press [**PTY**] one or more times to select your preferred programme type. Press [**◀◀ ▶▶**]. The tuner will search automatically. When a station is found the search will stop.

Listening to cassette tapes

Operation	MAIN UNIT	ON REMOTE
1 Open the tape door :	push open	-
2 Insert the tape :	-	-
3 Close the tape door :	-	-
4 Select the TAPE function :	INPUT SELECTOR	TAPE
5 Start the tape playing :	▶ or ▶ one more	▶ or ▶ one more
6 To stop a tape playing :	■	■

Listen to cassette tapes - more you can do

Play Fast backward or Forward

After pressing [**◀◀**] or [**▶▶**] (**◀◀** or **▶▶**) on the remote control) during playback, or stop, press [**▶**] again at a point you want.

Auto Stop Deck :

After playing one side of the tape, the unit stop automatically.

Auto Reverse Deck :

You can select direction of the cassette you want by pressing [**↻**] button repeatedly.

Press [**INPUT SELECTOR**] to select Tape. You can set the tape to play one side (◀), both sides (◀▶), or both sides six times (◀▶), by pressing one or more times.

Tape Recording

Operation		MAIN UNIT	ON REMOTE
1	Open the tape door :	push open	–
2	Insert a blank tape :	–	–
3	Close the tape door :	–	–
4	Select a mode (TUNER, DVD/CD, USB, PORTABLE), in which you want to record :	INPUT SELECTOR	Source buttons
5	Press : In the DVD/CD mode, "USB REC" or "TAPE REC" appears on the display.	USB/TAPE rec	●/II
6	Set "TAPE REC" (DVD/CD mode) : Select "TAPE REC" when recording an audio CD. Press (except in DVD/CD mode) :	USB/TAPE rec	●/II
7	Press : This operation is necessary only in DVD/CD mode.	▶	▶
8	To stop recording :	■	■

CD Synchronized Recording

Operation		MAIN UNIT	ON REMOTE
1	Open the tape door :	push open	–
2	Insert a blank tape :	–	–
3	Close the tape door :	–	–
4	Select the DVD/CD function :	INPUT SELECTOR	DVD/CD
5	Start recording in the stop mode : The synchronized recording is started automatically after about 7 seconds.	CD sync	–
6	To stop recording :	■	■

Listening to music from your portable player

The unit can be used to play the music from portable player.

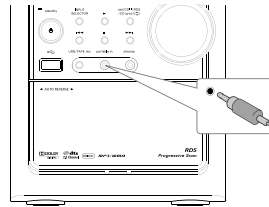

Operation		MAIN UNIT	ON REMOTE
1	Connect the portable player by plugging the unit into portable in on the unit :	–	–
2	Turn the power on :	⏻	⏻
3	Select the PORTABLE function :	INPUT SELECTOR	PORTABLE
4	Turn the portable player on and start it playing :	–	–

Connecting your portable USB player

The advantage of connecting your portable USB player through the system's USB port is that the portable device can be controlled from the system. Connect the portable player to the system using a USB cable (not supplied).

Operation	MAIN UNIT	ON REMOTE
1 Select the USB function :	INPUT SELECTOR	USB
2 The display will show "SEARCHING", followed by the number of files displayed :	-	-
3 Select a title menu : (page 14)	-	TOP MENU
4 Start selected file :	▶	SELECT/ENTER
5 Before disconnecting the portable USB player, change to any other function by pressing :	INPUT SELECTOR	Source buttons
6 Remove the USB player :	-	-

Compatible USB Devices

- Devices which require additional program installation when you have connected it to a computer, are not supported.
- MP3 Player : Flash type MP3 player.
The MP3 player requiring installation of a driver is not supported.
- USB Flash Drive : Devices that support USB2.0 or USB1.1.

USB device requirement

- USB devices belonging to the USB mass storage class.
- USB devices whose maximum current consumption is 500 mA or less.
- Do not extract the USB device in operating.
- A back up demands to prevent a data damage.
- If you use a USB extension cable or USB hub, the USB device might not be recognized.
- A device using NTFS file system is not supported. (Only FAT (16/32) file system is supported.)
- The USB function of this unit does not support all USB devices.
- Digital camera and mobile phone are not supported.
- This unit is not supported when the total number of files is 1000 or more.
- If the drive of USB device is two or more, a drive folder is displayed on the screen. If you want to move to the previous menu after you select a folder, press **[RETURN]**.

USB Direct Recording

Record AUDIO CD source to USB

This function enables you to record music to a connected USB storage device from Audio CD.

Operation	MAIN UNIT	ON REMOTE
1 Select the DVD/CD mode :	INPUT SELECTOR	DVD/CD
2 Select the track (file) :	◀◀/▶▶	◀◀/▶▶
3 Press : Appears "USB REC" or "TAPE REC" on the display window.	USB/TAPE rec	●/
4 Selects "USB REC" :	USB/TAPE rec	●/
5 To stop a Recording :	■	■

USB Direct Recording - more you can do

Record AUDIO CD source to USB

One track recording: If the USB recording is played during playback of the CD, the only track would be recording into the USB.

All track recording: If the USB REC button is pressed at the CD stop, all track would be recording.

Program list recording: USB Records after selecting the tracks pressing **[P.MODE]** if you want to record the track you want.

NOTES :

- When you start the USB direct recording, you can check the Recording percentage rate for the USB record on the display window during the recording.
- During the recording is no sound and not operate for volume.
- When you stop recording during playback, the file that has been recorded at that time will be stored.
- If you disconnect the USB without STOP button while recording, the file can not delete in the PC.
- Playable USB REC. Bit rate : 96/128kbps (Refer to the "Adjust the settings" page 10)
- During USB record can not operate Pause key for Audio CD only.
- Multicard reader device can not be use for USB record.
- USB port of the unit can not be connected to PC. The unit can not be used as a storage device.
- If the USB can not record appears "NO USB", "ERROR", "USB FULL", "NO REC" on the display window.
- File will be stored to KWD folder in a format "track001.mp3".
- In the state CD-G, USB direct Recording is not operated.
- If you record more 999 files on KWD folder appears "ERROR" on the display.
- New files are numbered in numeric sequence. if the total number of the files are more than 999, delete some or store some in PC.
- External HDD, Card reader and Locked device is not supported.
- Never stop recording in no more than 2 seconds after it is started. Otherwise, a normal recording file cannot be created.

Notes

About MP3 and WMA

- **Playable Audio file**
MP3 (.mp3), WMA (.wma)
- **Playable disc file format**
ISO 9660 Level 1/2, Joliet.

Although the audio files are complied with the standards listed above, the play maybe impossible depending on the types or conditions of media or device.

- **Playing order of the Audio file**

In the example of folder/file tree shown below, the files are played in the order from ① to ⑩.

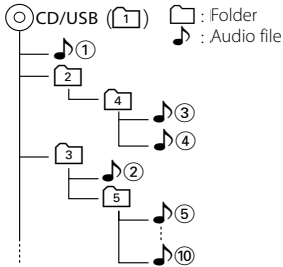

About DivX

DivX is a popular media technology created by DivX, Inc. DivX media Files contain highly compressed video with high visual quality that maintains a relatively small file size. DivX files can also include advanced media features like menus, subtitles, and alternate audio tracks. Many DivX media files are available for download online, and you can create your own using your personal content and easy-to-use tools from DivX.com.

About DivX Certified

DivX Certified products are officially tested by the creators of DivX and guaranteed to play of DivX video, without DivX 6.

Certified products qualify for one of several DivX Profiles that designate the type of video the product supports, from compact portable video to high-definition video.

Copyrights

It is forbidden by law to copy, broadcast, show, broadcast via cable, play in public, or rent copyrighted material without permission. This product features the copy protection function developed by Macrovision. Copy protection signals are recorded on some discs. When recording and playing the pictures of these discs picture noise will appear. This product incorporates copyright protection technology that is protected by method claims of certain U.S. patents and other intellectual property rights owned by Macrovision Corporation and other rights owners. Use of this copyright protection technology must be authorized by Macrovision Corporation, and is intended for home and other limited viewing uses only unless otherwise authorized by Macrovision Corporation. Reverse engineering or disassembly is prohibited.

CONSUMERS SHOULD NOTE THAT NOT ALL HIGH DEFINITION TELEVISION SETS ARE FULLY COMPATIBLE WITH THIS PRODUCT AND MAY CAUSE ARTIFACTS TO BE DISPLAYED IN THE PICTURE. IN CASE OF 525 OR 625 PROGRESSIVE SCAN PICTURE PROBLEMS, IT IS RECOMMENDED THAT THE USER SWITCH THE CONNECTION TO THE 'STANDARD DEFINITION' OUTPUT. IF THERE ARE QUESTIONS REGARDING OUR TV SET COMPATIBILITY WITH THIS MODEL 525p AND 625p UNIT, PLEASE CONTACT OUR CUSTOMER SERVICE CENTER.

Manufactured under license from Dolby Laboratories. Dolby and the double-D symbol are trademarks of Dolby Laboratories.

Manufactured under license under U.S. Patent #s: 5,451,942; 5,956,674; 5,974,380; 5,978,762; 6,487,535 & other U.S. and worldwide patents issued & pending. DTS is a registered trademark and the DTS logos, Symbol and DTS 2.0 Channel are trademarks of DTS, Inc. © 1996-2007 DTS, Inc. All Rights Reserved.

DivX, DivX Certified, and associated logos are trademarks of DivX, Inc. and are used under license.

Handling of disc

Handling precautions

Hold a disc taking care not to touch the played surface.

Notes on CD-R/CD-RW discs

If the CD-R or CD-RW disc in use has a printable label surface, the disc may be unable to be taken out of the system due to sticking of the label surface. To prevent malfunction of the system, do not use such a disc.

Cautions on discs

The disc rotates at a high speed during playback. Never use a cracked, chipped or greatly warped disc. Otherwise, damage or malfunction of the player may result.

Also, do not use a disc with a non-circular shape as this may result in malfunction.

Handling of disc

Care and storage of main unit

■ Do not place in the following locations.

- Place exposed to direct sunlight.
- Place subjected to excessive humidity or dirt.
- Place exposed to direct heat from heating equipment.

■ Be careful against condensation

When the difference in temperatures between the main unit and the environmental air is large, dew may be condensed inside the main unit and may cause malfunction of the main unit. If this happens, leave the main unit for a few hours until its internal mechanisms are dried up.

Take special care against condensation when the main unit is moved between places with a large temperature difference or into a room with high humidity.

■ When a main unit becomes dirty

When the front panel or case gets dirty, wipe with a soft dry cloth. Do not use lacquer thinner, benzene, alcohol or contact revitalizer for these chemicals will cause discoloration or deformation.

Care and storage of disc

■ Before storing the disc

When the main unit is not to be used for a long period, take out the disc and store in the case.

■ When a disc becomes dirty

- When a disc is contaminated with fingerprints or other stains, wipe gently in the radial direction using a soft dry cloth.
- Do not use an analog disk cleaner, lacquer thinner, benzene or alcohol.
- Do not use a disc accessory (stabilizer, protective sheet, protective ring, etc.) or lens cleaner.

■ Other cautions

- Do not write letters on a disc using a pencil or ballpoint pen.
- Do not use a disc if the sticker or label on it is peeled off or bond is overflowed around the sticker or label.
- Do not stick a sheet of paper, sticker or label on a disc.

Language Codes / Area Codes

Language Codes

Use this list to input your desired language for the following initial settings: Disc Audio, Disc Subtitle, Disc Menu.

Language	Code	Language	Code	Language	Code	Language	Code
Afar	6565	French	7082	Lithuanian	7684	Singhalese	8373
Afrikaans	6570	Frisian	7089	Macedonian	7775	Slovak	8375
Albanian	8381	Galician	7176	Malagasy	7771	Slovenian	8376
Amharic	6577	Georgian	7565	Malay	7783	Spanish	6983
Arabic	6582	German	6869	Malayalam	7776	Sundanese	8385
Armenian	7289	Greek	6976	Maori	7773	Swahili	8387
Assamese	6583	Greenlandic	7576	Marathi	7782	Swedish	8386
Aymara	6588	Guarani	7178	Moldavian	7779	Tagalog	8476
Azerbaijani	6590	Gujarati	7185	Mongolian	7778	Tajik	8471
Bashkir	6665	Hausa	7265	Nauru	7865	Tamil	8465
Basque	6985	Hebrew	7387	Nepali	7869	Telugu	8469
Bengali, Bangla	6678	Hindi	7273	Norwegian	7879	Thai	8472
Bhutani	6890	Hungarian	7285	Oriya	7982	Tonga	8479
Bihari	6672	Icelandic	7383	Panjabi	8065	Turkish	8482
Breton	6682	Indonesian	7378	Pashto, Pushto	8083	Turkmen	8475
Bulgarian	6671	Interlingua	7365	Persian	7065	Twi	8487
Burmese	7789	Irish	7165	Polish	8076	Ukrainian	8575
Byelorussian	6669	Italian	7384	Portuguese	8084	Urdu	8582
Chinese	9072	Javanese	7487	Quechua	8185	Uzbek	8590
Croatian	7282	Kannada	7578	Rhaeto-Romance	8277	Vietnamese	8673
Czech	6783	Kashmiri	7583	Romanian	8279	Volapük	8679
Danish	6865	Kazakh	7575	Russian	8285	Welsh	6789
Dutch	7876	Kirghiz	7589	Samoan	8377	Wolof	8779
English	6978	Korean	7579	Sanskrit	8365	Xhosa	8872
Esperanto	6979	Kurdish	7585	Scots Gaelic	7168	Yiddish	7473
Estonian	6984	Laothian	7679	Serbian	8382	Yoruba	8979
Faroese	7079	Latin	7665	Serbo-Croatian	8372	Zulu	9085
Fiji	7074	Latvian, Lettish	7686	Shona	8378		
Finnish	7073	Lingala	7678	Sindhi	8368		

Area Codes

Choose an area code from this list.

Area	Code	Area	Code	Area	Code	Area	Code
Afghanistan	AF	Ethiopia	ET	Maldives	MV	Senegal	SN
Argentina	AR	Fiji	FJ	Mexico	MX	Singapore	SG
Australia	AU	Finland	FI	Monaco	MC	Slovak Republic	SK
Austria	AT	France	FR	Mongolia	MN	Slovenia	SI
Belgium	BE	Germany	DE	Morocco	MA	South Africa	ZA
Bhutan	BT	Great Britain	GB	Nepal	NP	South Korea	KR
Bolivia	BO	Greece	GR	Netherlands	NL	Spain	ES
Brazil	BR	Greenland	GL	Netherlands Antilles	AN	Sri Lanka	LK
Cambodia	KH	Hong Kong	HK	New Zealand	NZ	Sweden	SE
Canada	CA	Hungary	HU	Nigeria	NG	Switzerland	CH
Chile	CL	India	IN	Norway	NO	Taiwan	TW
China	CN	Indonesia	ID	Oman	OM	Thailand	TH
Colombia	CO	Israel	IL	Pakistan	PK	Turkey	TR
Congo	CG	Italy	IT	Panama	PA	Uganda	UG
Costa Rica	CR	Jamaica	JM	Paraguay	PY	Ukraine	UA
Croatia	HR	Japan	JP	Philippines	PH	United States	US
Czech Republic	CZ	Kenya	KE	Poland	PL	Uruguay	UY
Denmark	DK	Kuwait	KW	Portugal	PT	Uzbekistan	UZ
Ecuador	EC	Libya	LY	Romania	RO	Vietnam	VN
Egypt	EG	Luxembourg	LU	Russian Federation	RU	Zimbabwe	ZW
El Salvador	SV	Malaysia	MY	Saudi Arabia	SA		

In case of difficulty

Resetting the Microcomputer

With the unit turned on, press and hold both the [■ (STOP)] button on the main unit and the “0” button on the remote control unit simultaneously for more than 3 seconds.

Check that following guide for problem resolution.

General

No sound.

- ➔ Plug in AC cord securely.
- ➔ Set the VOLUME control to proper sound level.
- ➔ Make sure the source is set to the source you wish to operate.
- ➔ Pull out the headphones plug from the headphones jack.

The left and right sound outputs are reverse.

- ➔ Check the speaker connections and location.

The system displays features automatically.

- ➔ Switch off the demo operation.

The system does not operate by pressing any buttons.

- ➔ Unplug the AC cord and plug it back in.

CD/DVD/VCD player operation

“NO DISC” is displayed.

- ➔ Insert a disc correctly (label side up).
- ➔ Clean the disc.
- ➔ Use a new or readable disc.
- ➔ Wait until the moisture condensation at the lens has cleared.

NO picture.

- ➔ Place the disc on the disc tray correctly inside the guide.
- ➔ Clean the disc.
- ➔ Select the appropriate video input model on the TV so the picture from the unit appears on the TV.

USB operation

“NO USB” is displayed.

- ➔ Insert the USB device properly.

Radio reception

Noise in radio.

- ➔ Tune to a correct frequency.
- ➔ Adjust the direction of the FM antenna.
- ➔ AM antenna is built in; rotate the system to face a new direction.
- ➔ Increase the distance between the system and TV or VCR.

Cassette deck operation

Cannot record.

- ➔ Replace the tape or cover tabs with adhesive tape.
- ➔ Clean the head.
- ➔ Use only NORMAL (IEC I) tape.
- ➔ Do not use a cassette with more than 90-minute recording time, for the tape used in such a cassette is very thin and tends to cause problem such as entanglement around the pinch roller or could be easily cut off.

Timer / Clock

The timer is not working.

- ➔ Set the correct clock.
- ➔ Press the TIMER ON/OFF button to switch on the timer.
- ➔ Switch the system to standby mode.

The timer/clock is erased.

- ➔ Power has been interrupted or power cord has been disconnected. Set it again.

Remote control unit

Does not function properly.

- ➔ Replace the batteries.
- ➔ Remove the obstacles.
- ➔ Move closer to the system when using the remote control and make sure that you are pointing at unit's remote sensor.

Specifications

Main unit

Amplifier section

Rated output

Woofer.....50 W + 50 W RMS (1 kHz, 10%, 4 Ω)

DIN music power.....60 W + 60 W

Tuner section

FM tuner section

Reception frequency range

.....87.5 MHz ~ 108 MHz (50 kHz step)

AM tuner section

Reception frequency range

.....522 kHz ~ 1,620 kHz (9 kHz step)

DVD player section

Laser.....Semiconductor laser

[Video section]

Video output format.....NTSC/PAL

Composite video output level.....1 Vp-p (75 Ω)

Component Video output level

(Y-signal)1 Vp-p (75 Ω)

(Cb-signal)0.680 Vp-p (75 Ω)

(Cr-signal)0.680 Vp-p (75 Ω)

USB interface

Format.....USB host (Playing back/Recording)

Supported devices.....USB mass storage class device

Interface.....USB 2.0 (Full speed)/1.1

Supported file format.....FAT 16/ 32

Encoding format

MP3.....96 kbps/44.1 kHz stereo

128 kbps/44.1 kHz stereo

Decoding format

MP3

Sampling rate.....32/44.1/48 kHz

Bitrate.....32 ~ 320 kbps (CBR/VBR)

WMA (WMA9 : supported, DRM : not supported)

Sampling rate.....24/32/44.1/48 kHz

Bitrate.....48k ~ 192k bps (CBR/VBR)

ID3 tag.....Supported (ver. 2.2/2.3/2.4)

Maximum number of folders

.....999 folders *Folder + File ≤ 999 (at FAT 32)

Maximum number of files

.....999 files *Folder + File ≤ 999 (at FAT 32)

Maximum consumption.....Maximum 500 mA

Maximum layer.....8 layers

Cassette deck section

Track.....4-track, 2-channel stereo

General

Power consumption.....50 W

Dimensions (max).....W : 170 mm (6-11/16")

H : 243 mm (9-9/16")

D : 273 mm (10-11/16")

Weight (net).....3.2 kg (7.05 lb)

Speakers

Mounted speaker

Woofer.....120 mm, cone type

Tweeter.....50 mm, cone type

Enclosure.....Bass-reflex type

Impedance.....4 Ω

Maximum input power.....100 W

Rated input power.....50 W

Dimensions.....W : 174 mm (6-7/8")

H : 243 mm (9-9/16")

D : 225 mm (8-7/8")

Weight.....2.9 kg (6.39 lb) (1 piece)

Notes:

- Kenwood follows a policy of continuous advancements in development. For this reason specifications may be changed without notice.
- Sufficient performance may not be exhibited at extremely cold locations (where water freezes).

Information on Disposal of Old Electrical and Electronic Equipment and Batteries (applicable for EU countries that have adopted separate waste collection systems)



Products and batteries with the symbol (crossed-out wheeled bin) cannot be disposed as household waste.



Old electrical and electronic equipment and batteries should be recycled at a facility capable of handling these items and their waste byproducts.



Pb

Contact your local authority for details in locating a recycle facility nearest to you. Proper recycling and waste disposal will help conserve resources whilst preventing detrimental effects on our health and the environment.

Notice: The sign "Pb" below the symbol for batteries indicates that this battery contains lead.

KENWOOD

For your records

Record the serial number, found on the back of the unit, in the spaces designated on the warranty card, and in the space provided below. Refer to the model and serial numbers whenever you call upon your dealer for information or service on this product.

Model _____ Serial Number _____